

VERITAS Volume Manager 4.1

Administrator's Guide

HP-UX

N12974G

June 2005

Disclaimer

The information contained in this publication is subject to change without notice. VERITAS Software Corporation makes no warranty of any kind with regard to this manual, including, but not limited to, the implied warranties of merchantability and fitness for a particular purpose. VERITAS Software Corporation shall not be liable for errors contained herein or for incidental or consequential damages in connection with the furnishing, performance, or use of this manual.

VERITAS Legal Notice

Copyright © 2005 VERITAS Software Corporation. All rights reserved. VERITAS, the VERITAS Logo, VERITAS Storage Foundation and FlashSnap are trademarks or registered trademarks of VERITAS Software Corporation or its affiliates in the U.S. and other countries. Other names may be trademarks of their respective owners.

VERITAS Software Corporation
350 Ellis Street
Mountain View, CA 94043
USA
Phone 650-527-8000 Fax 650-527-2908
www.veritas.com

Third-Party Legal Notices

Data Encryption Standard (DES) Copyright

Copyright © 1990 Dennis Ferguson. All rights reserved.

Commercial use is permitted only if products that are derived from or include this software are made available for purchase and/or use in Canada. Otherwise, redistribution and use in source and binary forms are permitted.

Copyright 1985, 1986, 1987, 1988, 1990 by the Massachusetts Institute of Technology. All rights reserved.

Export of this software from the United States of America may require a specific license from the United States Government. It is the responsibility of any person or organization contemplating export to obtain such a license before exporting.

WITHIN THAT CONSTRAINT, permission to use, copy, modify, and distribute this software and its documentation for any purpose and without fee is hereby granted, provided that the above copyright notice appear in all copies and that both that copyright notice and this permission notice appear in supporting documentation, and that the name of M.I.T. not be used in advertising or publicity pertaining to distribution of the software without specific, written prior permission. M.I.T. makes no representations about the suitability of this software for any purpose. It is provided as is without express or implied warranty.

Contents

Preface	xix
How This Guide Is Organized	xx
Conventions	xxi
Getting Help	xxii
Documentation Feedback	xxii
Chapter 1. Understanding VERITAS Volume Manager	1
VxVM and the Operating System	3
How Data is Stored	3
How VxVM Handles Storage Management	4
Physical Objects—Physical Disks	4
Virtual Objects	8
Volume Layouts in VxVM	17
Implementation of Non-Layered Volumes	17
Implementation of Layered Volumes	17
Layout Methods	18
Concatenation and Spanning	18
Striping (RAID-0)	21
Mirroring (RAID-1)	25
Striping Plus Mirroring (Mirrored-Stripe or RAID-0+1)	25
Mirroring Plus Striping (Striped-Mirror, RAID-1+0 or RAID-10)	26
RAID-5 (Striping with Parity)	29
Layered Volumes	34
Online Relayout	36



How Online Relayout Works	36
Limitations of Online Relayout	39
Transformation Characteristics	40
Transformations and Volume Length	40
Volume Resynchronization	41
Dirty Flags	41
Resynchronization Process	41
Dirty Region Logging (DRL)	42
Dirty Region Logs	42
Log Subdisks and Plexes	43
Sequential DRL	43
SmartSync Recovery Accelerator	44
Data Volume Configuration	44
Redo Log Volume Configuration	45
Volume Snapshots	45
Comparison of Snapshot Features	47
FastResync	49
FastResync Enhancements	49
Non-Persistent FastResync	50
Persistent FastResync	50
DCO Volume Versioning	51
FastResync Limitations	57
Hot-Relocation	58
Volume Sets	58
Chapter 2. Administering Disks	59
Disk Devices	59
Disk Device Naming in VxVM	60
Private and Public Disk Regions	61
Discovering and Configuring Newly Added Disk Devices	63



Partial Device Discovery	63
Discovering Disks and Dynamically Adding Disk Arrays	64
Third-Party Driver Coexistence	65
Administering the Device Discovery Layer	66
Placing Disks Under VxVM Control	71
Changing the Disk-Naming Scheme	72
Changing Device Naming for TPD-Controlled Enclosures	72
Discovering the Association between Enclosure-Based Disk Names and OS-Based Disk Names	73
Regenerating the Persistent Device Name Database	74
Issues Regarding Persistent Simple/Nopriv Disks with Enclosure-Based Naming . 75	
Installing and Formatting Disks	76
Displaying and Changing Default Disk Layout Attributes	77
Adding a Disk to VxVM	77
Reinitializing a Disk	81
Using vxdiskadd to Place a Disk Under Control of VxVM	81
Rootability	82
VxVM Root Disk Volume Restrictions	82
Root Disk Mirrors	83
Booting Root Volumes	83
Setting up a VxVM Root Disk and Mirror	84
Creating an LVM Root Disk from a VxVM Root Disk	85
Adding Swap Disks to a VxVM Rootable System	86
Removing Disks	87
Removing a Disk with Subdisks	88
Removing a Disk with No Subdisks	89
Removing a Disk from VxVM Control	89
Removing and Replacing Disks	90
Replacing a Failed or Removed Disk	93
Enabling a Physical Disk	95



Taking a Disk Offline	96
Renaming a Disk	97
Reserving Disks	98
Displaying Disk Information	98
Displaying Disk Information with vxdiskadm	99
Chapter 3. Administering Dynamic Multipathing (DMP)	101
How DMP Works	101
Path Failover Mechanism	104
Load Balancing	104
DMP in a Clustered Environment	105
Disabling and Enabling Multipathing for Specific Devices	106
Disabling Multipathing and Making Devices Invisible to VxVM	106
Enabling Multipathing and Making Devices Visible to VxVM	107
Enabling and Disabling Input/Output (I/O) Controllers	109
Displaying DMP Database Information	109
Displaying Multipaths to a VM Disk	110
Administering DMP Using vxdkmpadm	111
Retrieving Information About a DMP Node	112
Displaying the Members of a LUN Group	112
Displaying All Paths Controlled by a DMP Node	113
Listing Information About Host I/O Controllers	114
Listing Information About Enclosures	114
Displaying Information About TPD-Controlled Devices	115
Gathering and Displaying I/O Statistics	116
Setting the Attributes of the Paths to an Enclosure	118
Displaying the I/O Policy	120
Specifying the I/O Policy	120
Example of Applying Load Balancing in a SAN	123
Disabling a Controller	125



Enabling a Controller	126
Renaming an Enclosure	126
Starting the DMP Restore Daemon	127
Stopping the DMP Restore Daemon	128
Displaying the Status of the DMP Restore Daemon	128
Displaying Information About the DMP Error Daemons	128
Configuring Array Policy Modules	129
Chapter 4. Creating and Administering Disk Groups	131
Specifying a Disk Group to Commands	132
System-Wide Reserved Disk Groups	133
Rules for Determining the Default Disk Group	133
Displaying Disk Group Information	135
Displaying Free Space in a Disk Group	136
Creating a Disk Group	137
Adding a Disk to a Disk Group	138
Removing a Disk from a Disk Group	138
Deporting a Disk Group	139
Importing a Disk Group	141
Renaming a Disk Group	142
Moving Disks Between Disk Groups	144
Moving Disk Groups Between Systems	144
Handling Errors when Importing Disks	145
Reserving Minor Numbers for Disk Groups	147
Compatibility of Disk Groups Between Platforms	148
Handling Conflicting Configuration Copies in a Disk Group	150
Example of a Serial Split Brain Condition in a Campus Cluster	150
Correcting Conflicting Configuration Information	154
Reorganizing the Contents of Disk Groups	155
Limitations of Disk Group Split and Join	159



Listing Objects Potentially Affected by a Move	160
Moving Objects Between Disk Groups	163
Splitting Disk Groups	165
Joining Disk Groups	166
Disabling a Disk Group	168
Destroying a Disk Group	168
Recovering a Destroyed Disk Group	168
Upgrading a Disk Group	169
Managing the Configuration Daemon in VxVM	173
Backing Up and Restoring Disk Group Configuration Data	174
Using vxnotify to Monitor Configuration Changes	174
Chapter 5. Creating and Administering Subdisks	175
Creating Subdisks	175
Displaying Subdisk Information	176
Moving Subdisks	176
Splitting Subdisks	177
Joining Subdisks	177
Associating Subdisks with Plexes	178
Associating Log Subdisks	179
Dissociating Subdisks from Plexes	180
Removing Subdisks	181
Changing Subdisk Attributes	182
Chapter 6. Creating and Administering Plexes	183
Creating Plexes	183
Creating a Striped Plex	184
Displaying Plex Information	184
Plex States	184
Plex Condition Flags	188
Plex Kernel States	189



Attaching and Associating Plexes	189
Taking Plexes Offline	190
Detaching Plexes	191
Reattaching Plexes	191
Moving Plexes	192
Copying Plexes	193
Dissociating and Removing Plexes	193
Changing Plex Attributes	194
Chapter 7. Creating Volumes	195
Types of Volume Layouts	196
Supported Volume Logs and Maps	197
Creating a Volume	198
Advanced Approach	198
Assisted Approach	199
Using vxassist	199
Setting Default Values for vxassist	201
Discovering the Maximum Size of a Volume	202
Disk Group Alignment Constraints on Volumes	202
Creating a Volume on Any Disk	203
Creating a Volume on Specific Disks	203
Specifying Ordered Allocation of Storage to Volumes	205
Creating a Mirrored Volume	209
Creating a Mirrored-Concatenated Volume	209
Creating a Concatenated-Mirror Volume	209
Creating a Volume with a Version 0 DCO Volume	210
Creating a Volume with a Version 20 DCO Volume	212
Creating a Volume with Dirty Region Logging Enabled	213
Creating a Striped Volume	214
Creating a Mirrored-Stripe Volume	215



Creating a Striped-Mirror Volume	215
Mirroring across Targets, Controllers or Enclosures	216
Creating a RAID-5 Volume	217
Creating a Volume Using vxmake	218
Creating a Volume Using a vxmake Description File	220
Initializing and Starting a Volume	221
Initializing and Starting a Volume Created Using vxmake	222
Accessing a Volume	222

Chapter 8. Administering Volumes 223

Displaying Volume Information	224
Volume States	225
Volume Kernel States	227
Monitoring and Controlling Tasks	227
Specifying Task Tags	227
Managing Tasks with vxtask	228
Stopping a Volume	230
Putting a Volume in Maintenance Mode	230
Starting a Volume	231
Adding a Mirror to a Volume	231
Mirroring All Volumes	232
Mirroring Volumes on a VM Disk	232
Removing a Mirror	233
Adding Logs and Maps to Volumes	234
Preparing a Volume for DRL and Instant Snapshots	235
Specifying Storage for Version 20 DCO Plexes	236
Using a DCO and DCO Volume with a RAID-5 Volume	237
Determining the DCO Version Number	238
Determining if DRL is Enabled on a Volume	238
Determining if DRL Logging is Active on a Volume	239



Disabling and Re-enabling DRL	239
Removing Support for DRL and Instant Snapshots from a Volume	239
Upgrading Existing Volumes to Use Version 20 DCOs	240
Adding Traditional DRL Logging to a Mirrored Volume	242
Removing a Traditional DRL Log	243
Adding a RAID-5 Log	243
Adding a RAID-5 Log using vxplex	244
Removing a RAID-5 Log	244
Resizing a Volume	245
Resizing Volumes using vxresize	246
Resizing Volumes using vxassist	247
Resizing Volumes using vxvol	248
Changing the Read Policy for Mirrored Volumes	249
Removing a Volume	250
Moving Volumes from a VM Disk	251
Enabling FastResync on a Volume	252
Checking Whether FastResync is Enabled on a Volume	253
Disabling FastResync	254
Performing Online Relayout	254
Permitted Relayout Transformations	255
Specifying a Non-Default Layout	257
Specifying a Plex for Relayout	258
Tagging a Relayout Operation	258
Viewing the Status of a Relayout	258
Controlling the Progress of a Relayout	259
Converting Between Layered and Non-Layered Volumes	260
Chapter 9. Administering Volume Snapshots	261
Traditional Third-Mirror Break-Off Snapshots	263
Full-Sized Instant Snapshots	265



Space-Optimized Instant Snapshots	267
Emulation of Third-Mirror Break-Off Snapshots	268
Cascaded Snapshots	269
Creating Multiple Snapshots	273
Restoring the Original Volume from a Snapshot	274
Creating Instant Snapshots	275
Creating Multiple Instant Snapshots	283
Creating Instant Snapshots of Volume Sets	284
Adding Snapshot Mirrors to a Volume	285
Removing a Snapshot Mirror from a Volume	286
Adding a Snapshot to a Cascaded Snapshot Hierarchy	286
Refreshing an Instant Snapshot (vxsnap refresh)	287
Reattaching an Instant Snapshot (vxsnap reattach)	287
Restoring a Volume from an Instant Snapshot (vxsnap restore)	288
Dissociating an Instant Snapshot (vxsnap dis)	289
Removing an Instant Snapshot	290
Splitting an Instant Snapshot Hierarchy (vxsnap split)	290
Displaying Instant Snapshot Information (vxsnap print)	291
Controlling Instant Snapshot Synchronization	292
Creating a Volume for Use as a Full-Sized Instant Snapshot	293
Creating a Shared Cache Object	294
Listing the Snapshots Created on a Cache	296
Tuning the Autogrow Attributes	296
Growing and Shrinking a Cache	297
Removing a Cache	298
Creating Traditional Third-Mirror Break-Off Snapshots	299
Converting a Plex into a Snapshot Plex	302
Creating Multiple Snapshots	303
Reattaching a Snapshot Volume (vxassist snapback)	304
Adding Plexes to a Snapshot Volume	305



Dissociating a Snapshot Volume (vxassist snapclear)	305
Displaying Snapshot Information (vxassist snapprint)	306
Adding a Version 0 DCO and DCO Volume	307
Specifying Storage for Version 0 DCO Plexes	308
Removing a Version 0 DCO and DCO Volume	309
Reattaching a Version 0 DCO and DCO Volume	310
Chapter 10. Creating and Administering Volume Sets	311
Creating a Volume Set	312
Adding a Volume to a Volume Set	312
Listing Details of Volume Sets	313
Stopping and Starting Volume Sets	313
Removing a Volume from a Volume Set	314
Chapter 11. Configuring Off-Host Processing	315
FastResync of Volume Snapshots	316
Disk Group Split and Join	316
Implementing Off-Host Processing Solutions	317
Implementing Online Backup	318
Implementing Decision Support	322
Chapter 12. Administering Hot-Relocation	327
How Hot-Relocation Works	328
Partial Disk Failure Mail Messages	331
Complete Disk Failure Mail Messages	332
How Space is Chosen for Relocation	332
Configuring a System for Hot-Relocation	333
Displaying Spare Disk Information	334
Marking a Disk as a Hot-Relocation Spare	335
Removing a Disk from Use as a Hot-Relocation Spare	336
Excluding a Disk from Hot-Relocation Use	337



Making a Disk Available for Hot-Relocation Use	338
Configuring Hot-Relocation to Use Only Spare Disks	339
Moving and Unrelocating Subdisks	339
Moving and Unrelocating Subdisks Using vxdiskadm	340
Moving and Unrelocating Subdisks Using vxassist	341
Moving and Unrelocating Subdisks Using vxunreloc	341
Restarting vxunreloc After Errors	343
Modifying the Behavior of Hot-Relocation	344
Chapter 13. Administering Cluster Functionality	347
Overview of Cluster Volume Management	348
Private and Shared Disk Groups	350
Activation Modes of Shared Disk Groups	351
Connectivity Policy of Shared Disk Groups	353
Effect of Disk Connectivity on Cluster Reconfiguration	357
Limitations of Shared Disk Groups	357
Cluster Initialization and Configuration	358
Cluster Reconfiguration	358
Volume Reconfiguration	361
Node Shutdown	364
Node Abort	365
Cluster Shutdown	365
Upgrading Cluster Functionality	365
Dirty Region Logging (DRL) in Cluster Environments	366
How DRL Works in a Cluster Environment	367
Multi-Host Failover Configurations	367
Import Lock	368
Failover	368
Corruption of Disk Group Configuration	369
Administering VxVM in Cluster Environments	370



Requesting Node Status and Discovering the Master Node	370
Determining if a Disk is Shareable	371
Listing Shared Disk Groups	371
Creating a Shared Disk Group	372
Forcibly Adding a Disk to a Disk Group	373
Importing Disk Groups as Shared	373
Converting a Disk Group from Shared to Private	374
Moving Objects Between Disk Groups	374
Splitting Disk Groups	375
Joining Disk Groups	375
Changing the Activation Mode on a Shared Disk Group	375
Setting the Disk Detach Policy on a Shared Disk Group	376
Setting the Disk Group Failure Policy on a Shared Disk Group	376
Creating Volumes with Exclusive Open Access by a Node	376
Setting Exclusive Open Access to a Volume by a Node	377
Displaying the Cluster Protocol Version	377
Displaying the Supported Cluster Protocol Version Range	378
Upgrading the Cluster Protocol Version	378
Recovering Volumes in Shared Disk Groups	379
Obtaining Cluster Performance Statistics	379
Chapter 14. Using VERITAS Storage Expert	381
How Storage Expert Works	382
Before Using Storage Expert	382
Running Storage Expert	382
Command Line Syntax	382
Discovering What a Rule Does	383
Displaying Rule Attributes and Their Default Values	383
Running a Rule	384
Identifying Configuration Problems Using Storage Expert	386



Recovery Time	386
Disk Groups	388
Disk Striping	390
Disk Sparing and Relocation Management	391
Hardware Failures	392
Rootability	392
System Hostname	392
Rule Definitions and Attributes	393
Chapter 15. Performance Monitoring and Tuning	399
Performance Guidelines	399
Data Assignment	399
Striping	400
Mirroring	400
Combining Mirroring and Striping	401
RAID-5	401
Volume Read Policies	402
Performance Monitoring	403
Setting Performance Priorities	403
Obtaining Performance Data	403
Using Performance Data	405
Tuning VxVM	408
General Tuning Guidelines	408
Tuning Guidelines for Large Systems	409
Changing Values of Tunables	410
Tunable Parameters	411
Appendix A. Commands Summary	421
Online Manual Pages	439
Section 1M — Administrative Commands	439
Section 4 — File Formats	443



Section 7 — Device Driver Interfaces	443
Appendix B. Configuring VERITAS Volume Manager	445
Setup Tasks After Installation	445
Adding Unsupported Disk Arrays as JBODS	446
Adding Foreign Devices	446
Adding Disks to Disk Groups	446
Guidelines for Configuring Storage	447
Guidelines for Protecting Your System and Data	447
Accessing Volume Devices	452
Controlling VxVM's View of Multipathed Devices	452
Configuring Cluster Support	452
Configuring Shared Disk Groups	453
Converting Existing VxVM Disk Groups to Shared Disk Groups	453
Reconfiguration Tasks	454
Changing the Name of the Default Disk Group	454
Enabling or Disabling Enclosure-Based Naming	454
Glossary	455
Index	469





Preface

The *VERITAS Volume Manager Administrator's Guide* provides information on how to use VERITAS Volume Manager (VxVM) from the command line.

This guide is intended for system administrators responsible for installing, configuring, and maintaining systems under the control of VERITAS Volume Manager.

The purpose of this guide is to provide the system administrator with a thorough knowledge of the procedures and concepts involved with volume management and system administration using VERITAS Volume Manager. This guide includes guidelines on how to take advantage of various advanced VxVM features, and instructions on how to use VxVM commands to create and manipulate objects in VERITAS Volume Manager.

This guide assumes that you have a:

- ◆ Working knowledge of the HP-UX operating system (OS).
- ◆ Basic understanding of HP-UX system administration .
- ◆ Basic understanding of storage management.

Details on how to use the VERITAS Enterprise Administrator (VEA) can be found in the *VERITAS Enterprise Administrator Getting Started* manual and VEA online help. Detailed descriptions of the VxVM commands and utilities, their options, and details on their use are located in the VxVM manual pages. Also see "[Commands Summary](#)" on page 421 for a listing of the commonly used commands in VxVM together with references to their descriptions.

Note Some features such as Intelligent Storage Provisioning (ISP), Cross-platform Data Sharing (CDS) and VERITAS FlashSnap™ software have their own dedicated administration guides.

Most VERITAS Volume Manager commands require superuser or other appropriate privileges.



How This Guide Is Organized

This guide is organized as follows:

- ◆ [Understanding VERITAS Volume Manager](#)
- ◆ [Administering Disks](#)
- ◆ [Administering Dynamic Multipathing \(DMP\)](#)
- ◆ [Creating and Administering Disk Groups](#)
- ◆ [Creating and Administering Subdisks](#)
- ◆ [Creating and Administering Plexes](#)
- ◆ [Creating Volumes](#)
- ◆ [Administering Volumes](#)
- ◆ [Administering Volume Snapshots](#)
- ◆ [Creating and Administering Volume Sets](#)
- ◆ [Configuring Off-Host Processing](#)
- ◆ [Administering Hot-Relocation](#)
- ◆ [Administering Cluster Functionality](#)
- ◆ [Using VERITAS Storage Expert](#)
- ◆ [Performance Monitoring and Tuning](#)
- ◆ [Commands Summary](#)
- ◆ [Configuring VERITAS Volume Manager](#)
- ◆ [Glossary](#)

Refer to the *Release Notes* for information about the other documentation that is provided with this product.



Conventions

Convention	Usage	Example
monospace	Used for path names, commands, output, directory and file names, functions, and parameters.	Read tunables from the <code>/etc/vx/tunefstab</code> file. See the <code>ls(1)</code> manual page for more information.
monospace (bold)	Indicates user input.	# ls pubs C:\> dir pubs
<i>italic</i>	Identifies book titles, new terms, emphasized text, and variables replaced with a name or value.	See the <i>User's Guide</i> for details. The variable <code>system_name</code> indicates the system on which to enter the command.
bold	Depicts GUI objects, such as fields, list boxes, menu selections, etc. Also depicts GUI commands.	Enter your password in the Password field. Press Return .
blue text	Indicates hypertext links.	See " Getting Help " on page xxii.
#	Unix superuser prompt (all shells).	# cp /pubs/4.0/user_book /release_mgnt/4.0/archive
C:\>	Windows user prompt.	C:\> copy \pubs\4.0\user_book c:\release_mgnt\4.0\archive



Getting Help

For technical assistance, visit <http://support.veritas.com> and select phone or email support. This site also provides access to resources such as TechNotes, product alerts, software downloads, hardware compatibility lists, and the VERITAS customer email notification service. Use the Knowledge Base Search feature to access additional product information, including current and past releases of product documentation.

Diagnostic tools are also available to assist in troubleshooting problems associated with the product. These tools are available on disc or can be downloaded from the VERITAS FTP site. See the `README.VRTSspt` file in the `/support` directory for details.

For license information, software updates and sales contacts, visit <https://my.veritas.com/productcenter/ContactVeritas.jsp>. For information on purchasing product documentation, visit <http://webstore.veritas.com>.

Documentation Feedback

Your feedback on product documentation is important to us. Send suggestions for improvements and reports on errors or omissions to foundation_docs@veritas.com. Include the title and part number of the document (located in the lower left corner of the title page), and chapter and section titles of the text on which you are reporting. Our goal is to ensure customer satisfaction by providing effective, quality documentation. For assistance with topics other than documentation, visit <http://support.veritas.com>.

Understanding VERITAS Volume Manager

1

VERITAS Volume Manager (VxVM) is a storage management subsystem that allows you to manage physical disks as logical devices called *volumes*. A volume is a logical device that appears to data management systems as a physical disk.

VxVM provides easy-to-use online disk storage management for computing environments and Storage Area Network (SAN) environments. Through support of Redundant Array of Independent Disks (RAID), VxVM protects against disk and hardware failure. Additionally, VxVM provides features that enable fault tolerance and fast recovery from disk failure.

VxVM overcomes physical restrictions imposed by hardware disk devices by providing a logical volume management layer. This allows volumes to span multiple disks.

VxVM provides the tools to improve performance and ensure data availability and integrity. VxVM also dynamically configures disk storage while the system is active.

The following sections of this chapter explain fundamental concepts of VxVM:

- ◆ [How VxVM Handles Storage Management](#)
- ◆ [Physical Objects—Physical Disks](#)
- ◆ [Virtual Objects](#)
- ◆ [Volume Layouts in VxVM](#)

The following sections introduce you to advanced features of VxVM:

- ◆ [Online Relayout](#)
- ◆ [Volume Resynchronization](#)
- ◆ [Dirty Region Logging \(DRL\)](#)
- ◆ [SmartSync Recovery Accelerator](#)
- ◆ [Volume Snapshots](#)
- ◆ [FastResync](#)
- ◆ [Hot-Relocation](#)



Further information on administering VERITAS Volume Manager may be found in the following documents:

- ◆ *VERITAS Storage Foundation Cross-Platform Data Sharing Administrator's Guide*

Provides more information on using the Cross-platform Data Sharing (CDS) feature of VERITAS Volume Manager, which allows you to move VxVM disks and objects between machines that are running under different operating systems.

Note CDS requires a VERITAS Storage Foundation license.

- ◆ *VERITAS Storage Foundation Intelligent Storage Provisioning Administrator's Guide*

Describes the command-line interface to the VERITAS Intelligent Storage Provisioning (ISP) feature, which uses a rule-based engine to create VxVM objects and make optimal usage of the available storage.

- ◆ *VERITAS FlashSnap Point-In-Time Copy Solutions Administrator's Guide*

Provides guidelines on using the features of the FlashSnap™ software to implement various point-in-time copy solutions for backup, and database replication.

Note VERITAS FlashSnap requires a separate license.

- ◆ *VERITAS Volume Manager Troubleshooting Guide*

Describes recovery from hardware failure, disk group configuration and restoration, command and transaction logging, and common error messages together with suggested solutions.

- ◆ *VERITAS Enterprise Administrator Getting Started*

Describes how to use the VERITAS Enterprise Administrator — the graphical user interface to VERITAS Volume Manager. More detailed information is available in the VEA online help.

VxVM and the Operating System

VxVM operates as a subsystem between your operating system and your data management systems, such as file systems and database management systems. VxVM is tightly coupled with the operating system. Before a disk can be brought under VxVM control, the disk must be accessible through the operating system device interface. VxVM is layered on top of the operating system interface services, and is dependent upon how the operating system accesses physical disks.

VxVM is dependent upon the operating system for the following functionality:

- ◆ operating system (disk) devices
- ◆ device handles
- ◆ VxVM dynamic multipathing (DMP) metadvice

This guide introduces you to the VxVM commands which are used to carry out the tasks associated with VxVM objects. These commands are described on the relevant manual pages and in the chapters of this guide where VxVM tasks are described.

VxVM relies on the following constantly running daemons for its operation:

- ◆ `vxconfigd`—The VxVM configuration daemon maintains disk and group configurations and communicates configuration changes to the kernel, and modifies configuration information stored on disks.
- ◆ `vxiod`—The VxVM I/O daemon provides extended I/O operations without blocking calling processes. Several `vxiod` daemons are usually started at boot time, and continue to run at all times.
- ◆ `vxrelocd`—The hot-relocation daemon monitors VxVM for events that affect redundancy, and performs hot-relocation to restore redundancy.

How Data is Stored

There are several methods used to store data on physical disks. These methods organize data on the disk so the data can be stored and retrieved efficiently. The basic method of disk organization is called *formatting*. Formatting prepares the hard disk so that files can be written to and retrieved from the disk by using a prearranged storage pattern.

Hard disks are formatted, and information stored, using two methods: physical-storage layout and logical-storage layout. VxVM uses the *logical-storage layout* method. The types of storage layout supported by VxVM are introduced in this chapter.



How VxVM Handles Storage Management

VxVM uses two types of *objects* to handle storage management: *physical objects* and *virtual objects*.

- ◆ **Physical Objects—Physical Disks** or other hardware with block and raw operating system device interfaces that are used to store data.
- ◆ **Virtual Objects**—When one or more physical disks are brought under the control of VxVM, it creates virtual objects called *volumes* on those physical disks. Each volume records and retrieves data from one or more physical disks. Volumes are accessed by file systems, databases, or other applications in the same way that physical disks are accessed. Volumes are also composed of other virtual objects (plexes and subdisks) that are used in changing the volume configuration. Volumes and their virtual components are called virtual objects or VxVM objects.

Physical Objects—Physical Disks

A *physical disk* is the basic storage device (media) where the data is ultimately stored. You can access the data on a physical disk by using a *device name* to locate the disk. The physical disk device name varies with the computer system you use. Not all parameters are used on all systems. Typical device names are of the form *c#t#d#*, where:

- ◆ *c#* specifies the controller
- ◆ *t#* specifies the target ID
- ◆ *d#* specifies the disk

The figure, “**Physical Disk Example**” on page 4, shows how a physical disk and device name (*devname*) are illustrated in this document. For example, device name *c0t0d0* is the entire hard disk connected to controller number 0 in the system, with a target ID of 0, and physical disk number 0.

Physical Disk Example

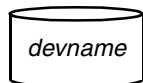

VxVM writes identification information on physical disks under VxVM control (VM disks). VxVM disks can be identified even after physical disk disconnection or system outages. VxVM can then re-form disk groups and logical objects to provide failure detection and to speed system recovery.

For HP-UX 11.x, all the disks are treated and accessed by VxVM as entire physical disks using a device name such as `c#t#d#`.

Disk Arrays

Performing I/O to disks is a relatively slow process because disks are physical devices that require time to move the heads to the correct position on the disk before reading or writing. If all of the read or write operations are done to individual disks, one at a time, the read-write time can become unmanageable. Performing these operations on multiple disks can help to reduce this problem.

A *disk array* is a collection of physical disks that VxVM can represent to the operating system as one or more virtual disks or volumes. The volumes created by VxVM look and act to the operating system like physical disks. Applications that interact with volumes should work in the same way as with physical disks.

“[How VxVM Presents the Disks in a Disk Array as Volumes to the Operating System](#)” on page 5 illustrates how VxVM represents the disks in a disk array as several volumes to the operating system.

Data can be spread across several disks within an array to distribute or *balance* I/O operations across the disks. Using parallel I/O across multiple disks in this way improves I/O performance by increasing data transfer speed and overall throughput for the array.

How VxVM Presents the Disks in a Disk Array as Volumes to the Operating System

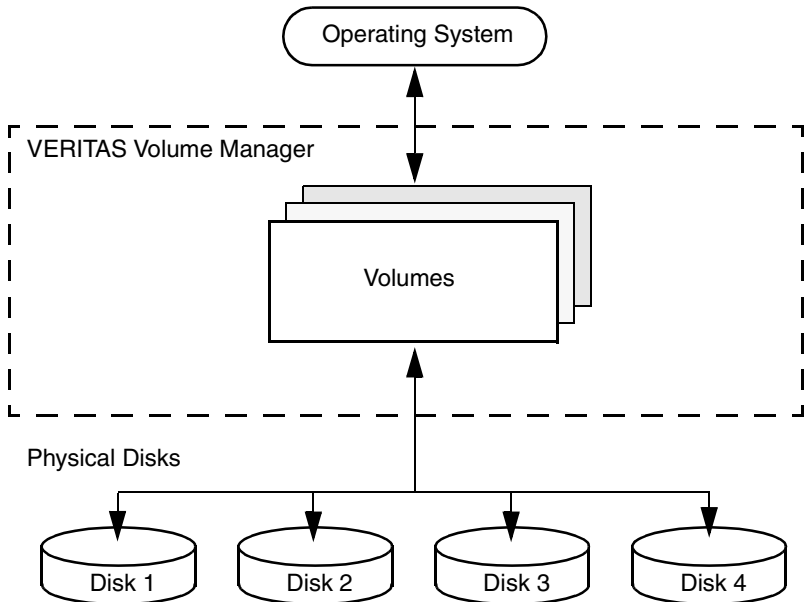

Multipathed Disk Arrays

Some disk arrays provide multiple ports to access their disk devices. These ports, coupled with the host bus adaptor (HBA) controller and any data bus or I/O processor local to the array, make up multiple hardware paths to access the disk devices. Such disk arrays are called *multipathed disk arrays*. This type of disk array can be connected to host systems in many different configurations, (such as multiple ports connected to different controllers on a single host, chaining of the ports through a single controller on a host, or ports connected to different hosts simultaneously). For more detailed information, see [“Administering Dynamic Multipathing \(DMP\)”](#) on page 101.

Device Discovery

Device Discovery is the term used to describe the process of discovering the disks that are attached to a host. This feature is important for DMP because it needs to support a growing number of disk arrays from a number of vendors. In conjunction with the ability to discover the devices attached to a host, the Device Discovery service enables you to add support dynamically for new disk arrays. This operation, which uses a facility called the Device Discovery Layer (DDL), is achieved without the need for a reboot.

This means that you can dynamically add a new disk array to a host, and run a command which scans the operating system’s device tree for all the attached disk devices, and reconfigures DMP with the new device database. For more information, see [“Administering the Device Discovery Layer”](#) on page 66.

Enclosure-Based Naming

Enclosure-based naming provides an alternative to the disk device naming described in [“Physical Objects—Physical Disks”](#) on page 4. This allows disk devices to be named for enclosures rather than for the controllers through which they are accessed. In a Storage Area Network (SAN) that uses Fibre Channel hubs or fabric switches, information about disk location provided by the operating system may not correctly indicate the physical location of the disks. For example, *c##t##d##* naming assigns controller-based device names to disks in separate enclosures that are connected to the same host controller.

Enclosure-based naming allows VxVM to access enclosures as separate physical entities. By configuring redundant copies of your data on separate enclosures, you can safeguard against failure of one or more enclosures.

In a typical SAN environment, host controllers are connected to multiple enclosures in a daisy chain or through a Fibre Channel hub or fabric switch as illustrated in [“Example Configuration for Disk Enclosures Connected via a Fibre Channel Hub/Switch.”](#)

Example Configuration for Disk Enclosures Connected via a Fibre Channel Hub/Switch

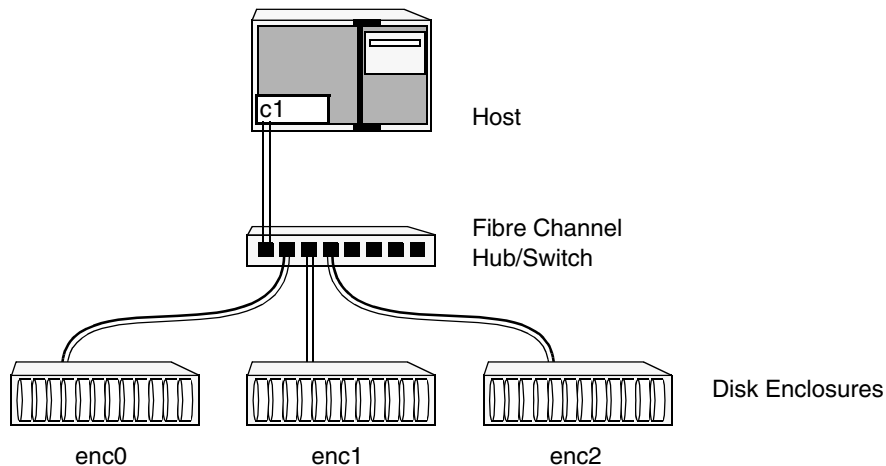

In such a configuration, enclosure-based naming can be used to refer to each disk within an enclosure. For example, the device names for the disks in enclosure `enc0` are named `enc0_0`, `enc0_1`, and so on. The main benefit of this scheme is that it allows you to quickly determine where a disk is physically located in a large SAN configuration.

Note In many advanced disk arrays, you can use hardware-based storage management to represent several physical disks as one logical disk device to the operating system. In such cases, VxVM also sees a single logical disk device rather than its component disks. For this reason, when reference is made to a *disk* within an enclosure, this disk may be either a physical or a logical device.

Another important benefit of enclosure-based naming is that it enables VxVM to avoid placing redundant copies of data in the same enclosure. This is a good thing to avoid as each enclosure can be considered to be a separate fault domain. For example, if a mirrored volume were configured only on the disks in enclosure `enc1`, the failure of the cable between the hub and the enclosure would make the entire volume unavailable.

If required, you can replace the default name that VxVM assigns to an enclosure with one that is more meaningful to your configuration. See [“Renaming an Enclosure”](#) on page 126 for details.

In High Availability (HA) configurations, redundant-loop access to storage can be implemented by connecting independent controllers on the host to separate hubs with independent paths to the enclosures as shown in [“Example HA Configuration Using Multiple Hubs/Switches to Provide Redundant-Loop Access”](#) on page 8. Such a configuration protects against the failure of one of the host controllers (`c1` and `c2`), or of the cable between the host and one of the hubs. In this example, each disk is known by the



same name to VxVM for all of the paths over which it can be accessed. For example, the disk device `enc0_0` represents a single disk for which two different paths are known to the operating system, such as `c1t99d0` and `c2t99d0`.

To take account of fault domains when configuring data redundancy, you can control how mirrored volumes are laid out across enclosures as described in “[Mirroring across Targets, Controllers or Enclosures](#)” on page 216.

Example HA Configuration Using Multiple Hubs/Switches to Provide Redundant-Loop Access

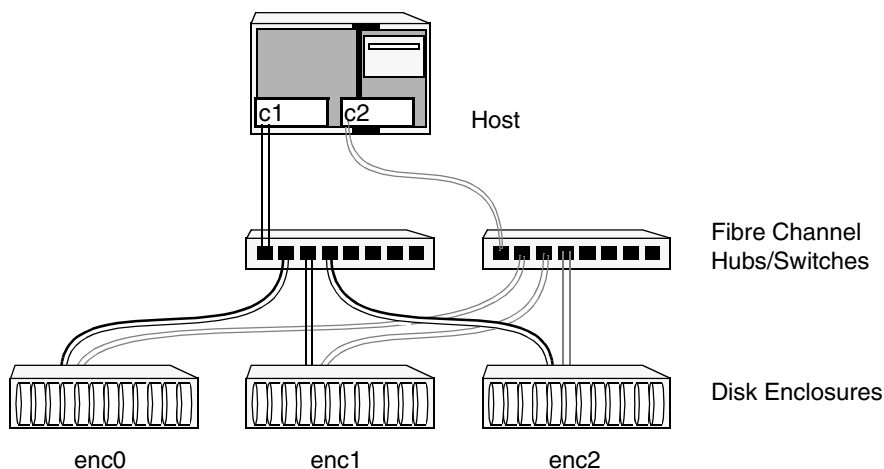

See “[Disk Device Naming in VxVM](#)” on page 60 and “[Changing the Disk-Naming Scheme](#)” on page 72 for details of the standard and the enclosure-based naming schemes, and how to switch between them.

Virtual Objects

Virtual objects in VxVM include the following:

- ◆ [Disk Groups](#)
- ◆ [VM Disks](#)
- ◆ [Subdisks](#)
- ◆ [Plexes](#)
- ◆ [Volumes](#)

The connection between physical objects and VxVM objects is made when you place a physical disk under VxVM control.

After installing VxVM on a host system, you must bring the contents of physical disks under VxVM control by collecting the VM disks into disk groups and allocating the disk group space to create logical volumes.

Note To bring the physical disk under VxVM control, the disk must not be under LVM control. For more information on how LVM and VM disks co-exist or how to convert LVM disks to VM disks, see the *VERITAS Volume Manager Migration Guide*

Bringing the contents of physical disks under VxVM control is accomplished only if VxVM takes control of the physical disks and the disk is not under control of another storage manager such as LVM.

VxVM creates virtual objects and makes logical connections between the objects. The virtual objects are then used by VxVM to do storage management tasks.

Note The `vxprint` command displays detailed information on existing VxVM objects. For additional information on the `vxprint` command, see “[Displaying Volume Information](#)” on page 224 and the `vxprint(1M)` manual page.

Combining Virtual Objects in VxVM

VxVM virtual objects are combined to build volumes. The virtual objects contained in volumes are VM disks, disk groups, subdisks, and plexes. VERITAS Volume Manager objects are organized as follows:

- ◆ VM disks are grouped into disk groups
- ◆ Subdisks (each representing a specific region of a disk) are combined to form plexes
- ◆ Volumes are composed of one or more plexes



The figure, “[Connection Between Objects in VxVM](#)” on page 10, shows the connections between VERITAS Volume Manager virtual objects and how they relate to physical disks. The disk group contains three VM disks which are used to create two volumes. Volume vol01 is simple and has a single plex. Volume vol02 is a mirrored volume with two plaxes.

Connection Between Objects in VxVM

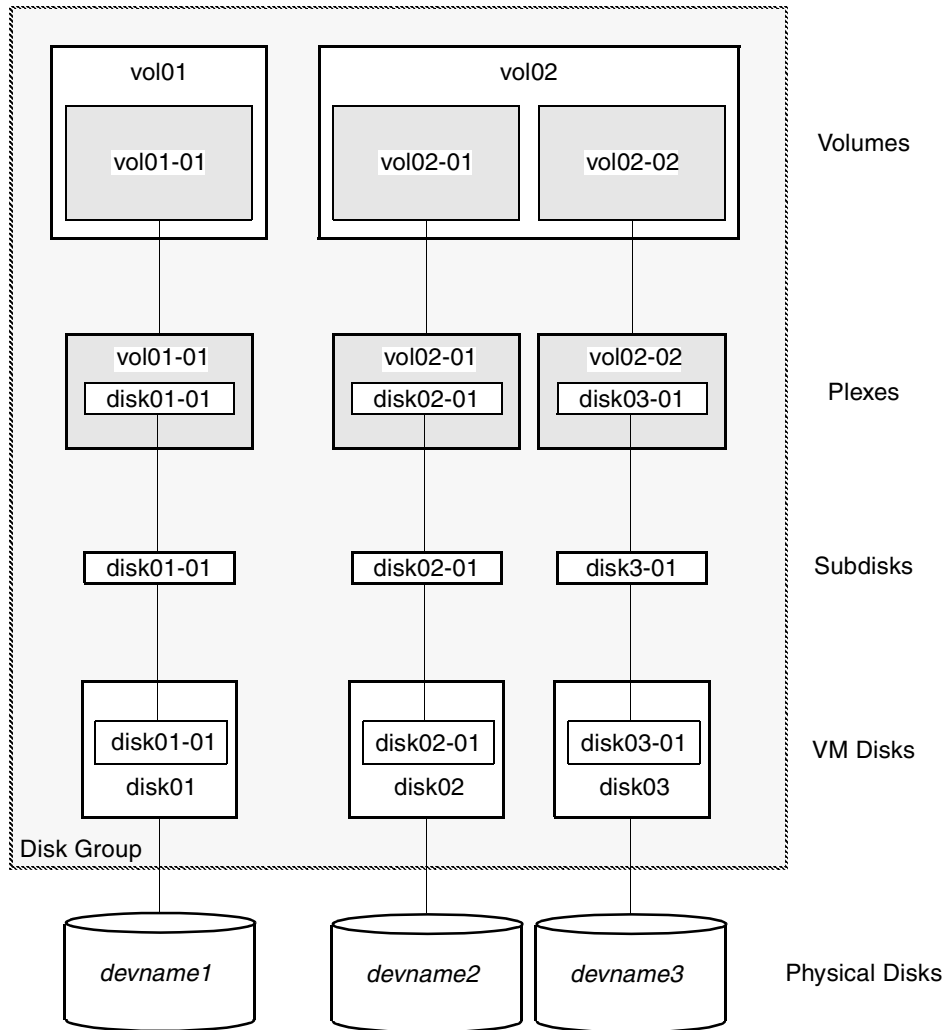

The various types of virtual objects (disk groups, VM disks, subdisks, plexes and volumes) are described in the following sections. Other types of objects exist in VERITAS Volume Manager, such as data change objects (DCOs), and cache objects, to provide extended functionality. These objects are discussed later in this chapter.

Disk Groups

A *disk group* is a collection of disks that share a common configuration, and which are managed by VxVM (see “[VM Disks](#)” on page 11). A disk group configuration is a set of records with detailed information about related VxVM objects, their attributes, and their connections. A disk group name can be up to 31 characters long.

In releases prior to VxVM 4.0, the default disk group was `rootdg` (the *root disk group*). For VxVM to function, the `rootdg` disk group had to exist and it had to contain at least one disk. This requirement no longer exists, and VxVM can work without any disk groups configured (although you must set up at least one disk group before you can create any volumes of other VxVM objects). For more information about changes to disk group configuration, see “[Creating and Administering Disk Groups](#)” on page 131.

You can create additional disk groups when you need them. Disk groups allow you to group disks into logical collections. A disk group and its components can be moved as a unit from one host machine to another. The ability to move whole volumes and disks between disk groups, to split whole volumes and disks between disk groups, and to join disk groups is described in “[Reorganizing the Contents of Disk Groups](#)” on page 155.

Volumes are created within a disk group. A given volume and its plexes and subdisks must be configured from disks in the same disk group.

VM Disks

When you place a physical disk under VxVM control, a VM disk is assigned to the physical disk. A VM disk is under VxVM control and is usually in a disk group. Each VM disk corresponds to one physical disk. VxVM allocates storage from a contiguous area of VxVM disk space.

A VM disk typically includes a *public region* (allocated storage) and a *private region* where VxVM internal configuration information is stored.

Each VM disk has a unique *disk media name* (a virtual disk name). You can either define a disk name of up to 31 characters, or allow VxVM to assign a default name that takes the form `diskgroup##`, where *diskgroup* is the name of the disk group to which the disk belongs (see “[Disk Groups](#)” on page 11).



“[VM Disk Example](#)” on page 12 shows a VM disk with a media name of `disk01` that is assigned to the physical disk `devname`.

VM Disk Example

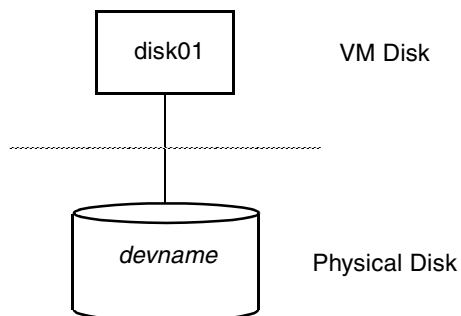

Subdisks

A *subdisk* is a set of contiguous disk blocks. A block is a unit of space on the disk. VxVM allocates disk space using subdisks. A VM disk can be divided into one or more subdisks. Each subdisk represents a specific portion of a VM disk, which is mapped to a specific region of a physical disk.

The default name for a VM disk is `diskgroup##` and the default name for a subdisk is `diskgroup##-##`, where `diskgroup` is the name of the disk group to which the disk belongs (see “[Disk Groups](#)” on page 11).

In the figure, “[Subdisk Example](#)” on page 12, `disk01-01` is the name of the first subdisk on the VM disk named `disk01`.

Subdisk Example

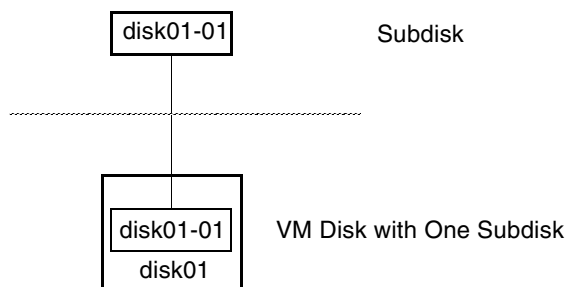

A VM disk can contain multiple subdisks, but subdisks cannot overlap or share the same portions of a VM disk. “[Example of Three Subdisks Assigned to One VM Disk](#)” on page 13 shows a VM disk with three subdisks. (The VM disk is assigned to one physical disk.)

Example of Three Subdisks Assigned to One VM Disk

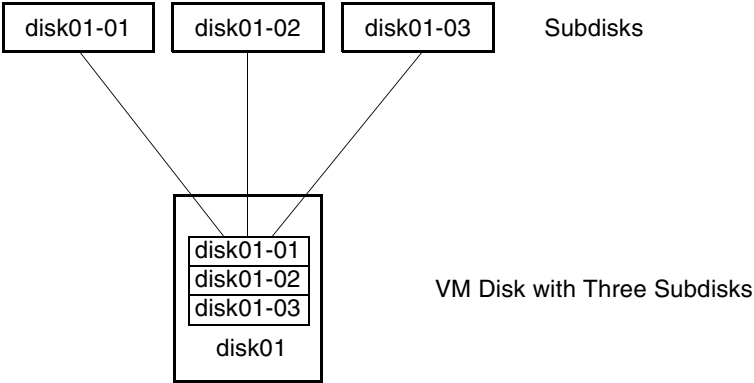

Any VM disk space that is not part of a subdisk is free space. You can use free space to create new subdisks.

VxVM release 3.0 or higher supports the concept of layered volumes in which subdisks can contain volumes. For more information, see “[Layered Volumes](#)” on page 34.



Plexes

VxVM uses subdisks to build virtual objects called *plexes*. A plex consists of one or more subdisks located on one or more physical disks. For example, see the plex `vol01-01` shown in “[Example of a Plex with Two Subdisks](#).”

Example of a Plex with Two Subdisks

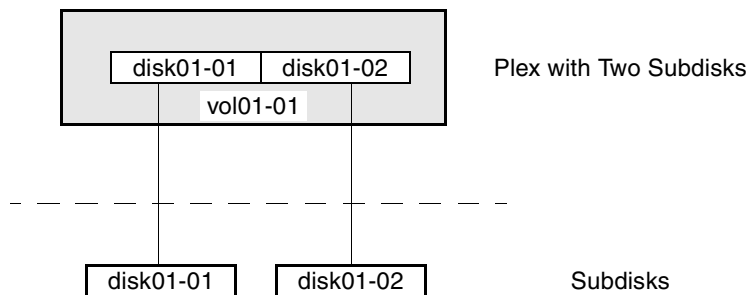

You can organize data on subdisks to form a plex by using the following methods:

- ◆ concatenation
- ◆ striping (RAID-0)
- ◆ mirroring (RAID-1)
- ◆ striping with parity (RAID-5)

Concatenation, striping (RAID-0), mirroring (RAID-1) and RAID-5 are described in “[Volume Layouts in VxVM](#)” on page 17.

Volumes

A *volume* is a virtual disk device that appears to applications, databases, and file systems like a physical disk device, but does not have the physical limitations of a physical disk device. A volume consists of one or more plexes, each holding a copy of the selected data in the volume. Due to its virtual nature, a volume is not restricted to a particular disk or a specific area of a disk. The configuration of a volume can be changed by using VxVM user interfaces. Configuration changes can be accomplished without causing disruption to applications or file systems that are using the volume. For example, a volume can be mirrored on separate disks or moved to use different disk storage.

Note VxVM uses the default naming conventions of `vol##` for volumes and `vol##-##` for plexes in a volume. For ease of administration, you can choose to select more meaningful names for the volumes that you create.

A volume may be created under the following constraints:

- ◆ Its name can contain up to 31 characters.
- ◆ It can consist of up to 32 plexes, each of which contains one or more subdisks.
- ◆ It must have at least one associated plex that has a complete copy of the data in the volume with at least one associated subdisk.
- ◆ All subdisks within a volume must belong to the same disk group.

Note You can use the VERITAS Intelligent Storage Provisioning (ISP) feature to create and administer application volumes. These volumes are very similar to the traditional VxVM volumes that are described in this chapter. However, there are significant differences between the functionality of the two types of volume that prevent them from being used interchangeably. Refer to the *VERITAS Storage Foundation Intelligent Storage Provisioning Administrator's Guide* for more information about creating and administering ISP application volumes.

In “[Example of a Volume with One Plex](#),” volume `vol01` has the following characteristics:

- ◆ It contains one plex named `vol01-01`.
- ◆ The plex contains one subdisk named `disk01-01`.
- ◆ The subdisk `disk01-01` is allocated from VM disk `disk01`.

Example of a Volume with One Plex

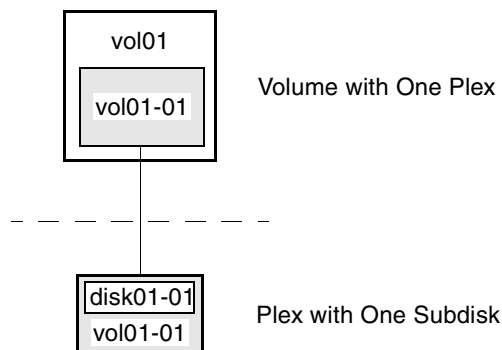

In “[Example of a Volume with Two Plexes](#),” a volume, `vol106`, with two data plexes is *mirrored*. Each plex of the mirror contains a complete copy of the volume data.

Example of a Volume with Two Plexes

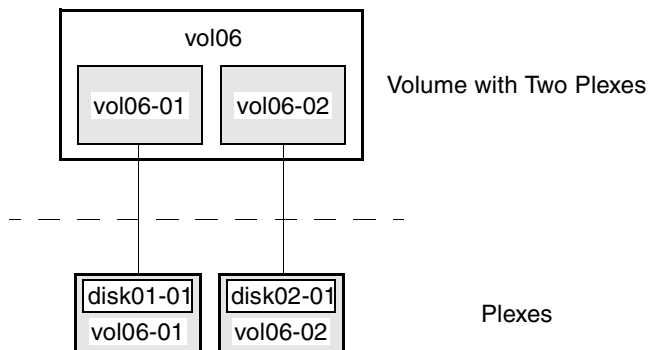

Volume `vol106` has the following characteristics:

- ◆ It contains two plexes named `vol106-01` and `vol106-02`.
- ◆ Each plex contains one subdisk.
- ◆ Each subdisk is allocated from a different VM disk (`disk01` and `disk02`).

For more information, see “[Mirroring \(RAID-1\)](#)” on page 25.

Volume Layouts in VxVM

A VxVM virtual device is defined by a volume. A volume has a layout defined by the association of a volume to one or more plexes, each of which map to subdisks. The volume presents a virtual device interface that is exposed to other applications for data access. These logical building blocks re-map the volume address space through which I/O is re-directed at run-time.

Different volume layouts each provide different levels of storage service. A volume layout can be configured and reconfigured to match particular levels of desired storage service.

Implementation of Non-Layered Volumes

In a *non-layered* volume, a subdisk is restricted to mapping directly to a VM disk. This allows the subdisk to define a contiguous extent of storage space backed by the public region of a VM disk. When active, the VM disk is directly associated with an underlying physical disk. The combination of a volume layout and the physical disks therefore determines the storage service available from a given virtual device.

Implementation of Layered Volumes

A *layered* volume is constructed by mapping its subdisks to underlying volumes. The subdisks in the underlying volumes must map to VM disks, and hence to attached physical storage.

Layered volumes allow for more combinations of logical compositions, some of which may be desirable for configuring a virtual device. Because permitting free use of layered volumes throughout the command level would have resulted in unwieldy administration, some ready-made layered volume configurations are designed into VxVM. See “[Layered Volumes](#)” on page 34 for more information.

These ready-made configurations operate with built-in rules to automatically match desired levels of service within specified constraints. The automatic configuration is done on a “best-effort” basis for the current command invocation working against the current configuration.

To achieve the desired storage service from a set of virtual devices, it may be necessary to include an appropriate set of VM disks into a disk group, and to execute multiple configuration commands.

To the extent that it can, VxVM handles initial configuration and on-line re-configuration with its set of layouts and administration interface to make this job easier and more deterministic.



Layout Methods

Data in virtual objects is organized to create volumes by using the following layout methods:

- ◆ [Concatenation and Spanning](#)
- ◆ [Striping \(RAID-0\)](#)
- ◆ [Mirroring \(RAID-1\)](#)
- ◆ [Striping Plus Mirroring \(Mirrored-Stripe or RAID-0+1\)](#)
- ◆ [Mirroring Plus Striping \(Striped-Mirror, RAID-1+0 or RAID-10\)](#)
- ◆ [RAID-5 \(Striping with Parity\)](#)

The following sections describe each layout method.

Concatenation and Spanning

Concatenation maps data in a linear manner onto one or more subdisks in a plex. To access all of the data in a concatenated plex sequentially, data is first accessed in the first subdisk from beginning to end. Data is then accessed in the remaining subdisks sequentially from beginning to end, until the end of the last subdisk.

The subdisks in a concatenated plex do not have to be physically contiguous and can belong to more than one VM disk. Concatenation using subdisks that reside on more than one VM disk is called *spanning*.

The figure, “[Example of Concatenation](#),” shows the concatenation of two subdisks from the same VM disk. The blocks n , $n+1$, $n+2$ and $n+3$ (numbered relative to the start of the plex) are contiguous on the plex, but actually come from two distinct subdisks on the same physical disk.

The remaining free space in the subdisk, `disk01-02`, on VM disk, `disk01`, can be put to other uses.

Example of Concatenation

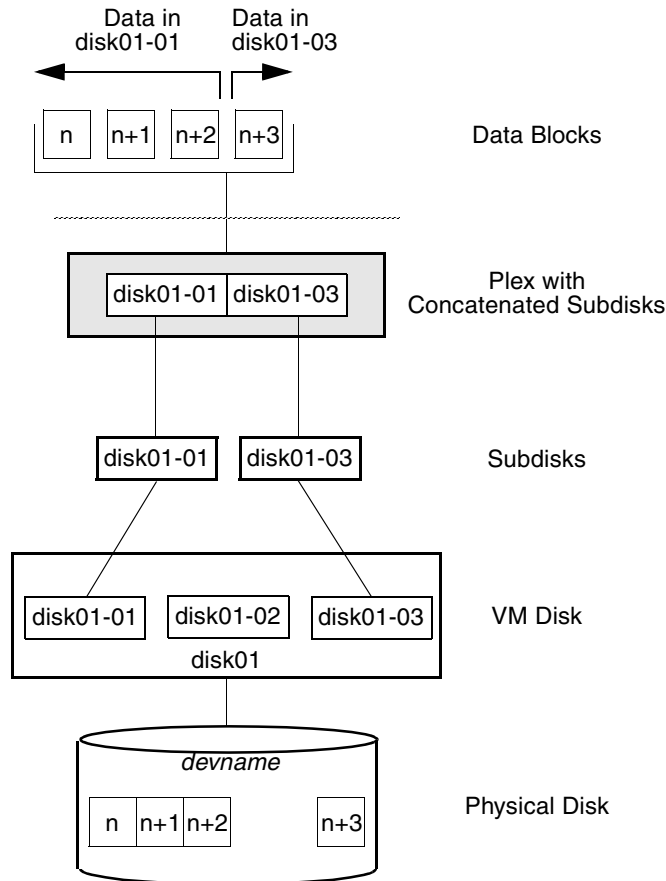

You can use concatenation with multiple subdisks when there is insufficient contiguous space for the plex on any one disk. This form of concatenation can be used for load balancing between disks, and for head movement optimization on a particular disk.

The figure, “[Example of Spanning](#)” on page 20, shows data spread over two subdisks in a spanned plex. The blocks `n`, `n+1`, `n+2` and `n+3` (numbered relative to the start of the plex) are contiguous on the plex, but actually come from two distinct subdisks from two distinct physical disks.



The remaining free space in the subdisk `disk02-02` on VM disk `disk02` can be put to other uses.

Example of Spanning

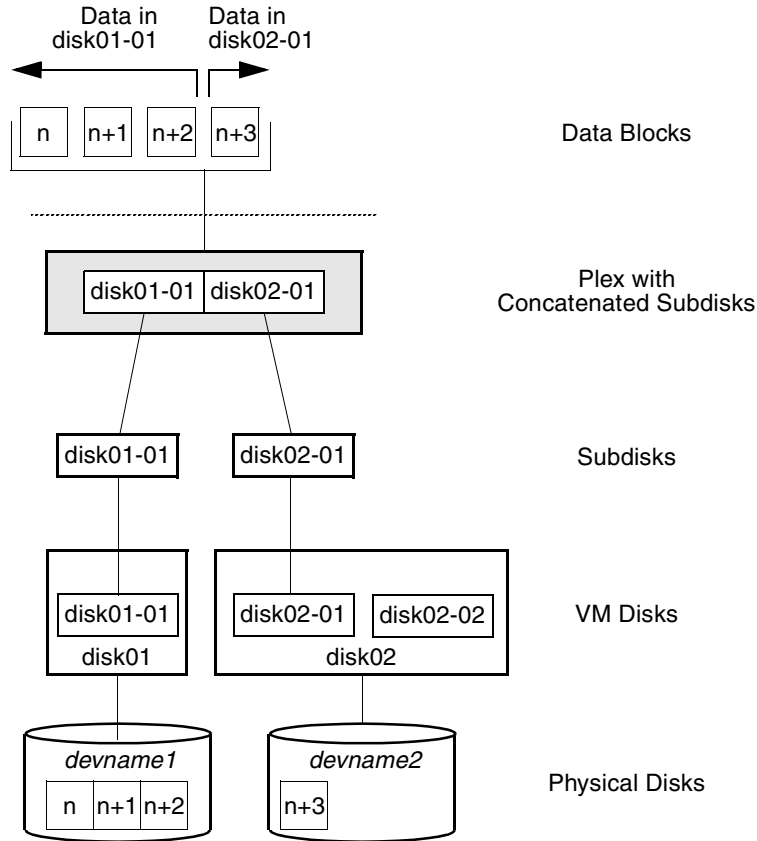

Caution Spanning a plex across multiple disks increases the chance that a disk failure results in failure of the assigned volume. Use mirroring or RAID-5 (both described later) to reduce the risk that a single disk failure results in a volume failure.

See [“Creating a Volume on Any Disk”](#) on page 203 for information on how to create a concatenated volume that may span several disks.



Striping (RAID-0)

Note You need a full license to use this feature.

Striping (RAID-0) is useful if you need large amounts of data written to or read from physical disks, and performance is important. Striping is also helpful in balancing the I/O load from multi-user applications across multiple disks. By using parallel data transfer to and from multiple disks, striping significantly improves data-access performance.

Striping maps data so that the data is interleaved among two or more physical disks. A striped plex contains two or more subdisks, spread out over two or more physical disks. Data is allocated alternately and evenly to the subdisks of a striped plex.

The subdisks are grouped into “columns,” with each physical disk limited to one column. Each column contains one or more subdisks and can be derived from one or more physical disks. The number and sizes of subdisks per column can vary. Additional subdisks can be added to columns, as necessary.

Caution Striping a volume, or splitting a volume across multiple disks, increases the chance that a disk failure will result in failure of that volume.

If five volumes are striped across the same five disks, then failure of any one of the five disks will require that all five volumes be restored from a backup. If each volume is on a separate disk, only one volume has to be restored. (As an alternative to striping, use mirroring or RAID-5 to substantially reduce the chance that a single disk failure results in failure of a large number of volumes.)

Data is allocated in equal-sized units (*stripe units*) that are interleaved between the columns. Each stripe unit is a set of contiguous blocks on a disk. The default stripe unit size (or *width*) is 64 kilobytes.

For example, if there are three columns in a striped plex and six stripe units, data is striped over the three columns, as illustrated in “[Striping Across Three Columns](#)” on page 22.



Striping Across Three Columns

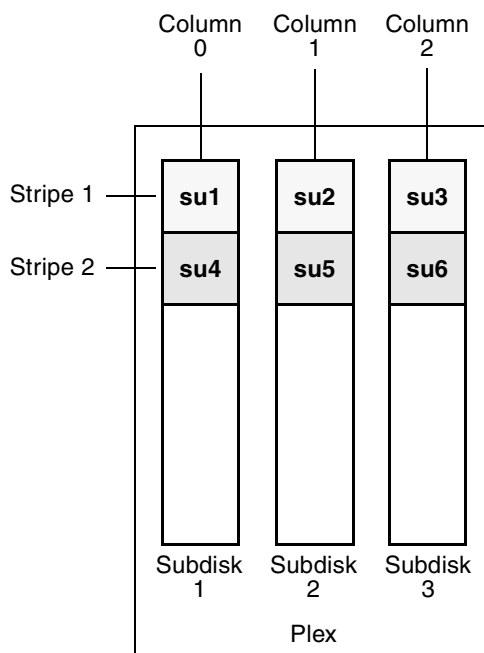

SU = Stripe Unit

A *stripe* consists of the set of stripe units at the same positions across all columns. In the figure, stripe units 1, 2, and 3 constitute a single stripe.

Viewed in sequence, the first stripe consists of:

- ◆ stripe unit 1 in column 0
- ◆ stripe unit 2 in column 1
- ◆ stripe unit 3 in column 2

The second stripe consists of:

- ◆ stripe unit 4 in column 0
- ◆ stripe unit 5 in column 1
- ◆ stripe unit 6 in column 2

Striping continues for the length of the columns (if all columns are the same length), or until the end of the shortest column is reached. Any space remaining at the end of subdisks in longer columns becomes unused space.

“Example of a Striped Plex with One Subdisk per Column” on page 23 shows a striped plex with three equal sized, single-subdisk columns. There is one column per physical disk. This example shows three subdisks that occupy all of the space on the VM disks. It is also possible for each subdisk in a striped plex to occupy only a portion of the VM disk, which leaves free space for other disk management tasks.

Example of a Striped Plex with One Subdisk per Column

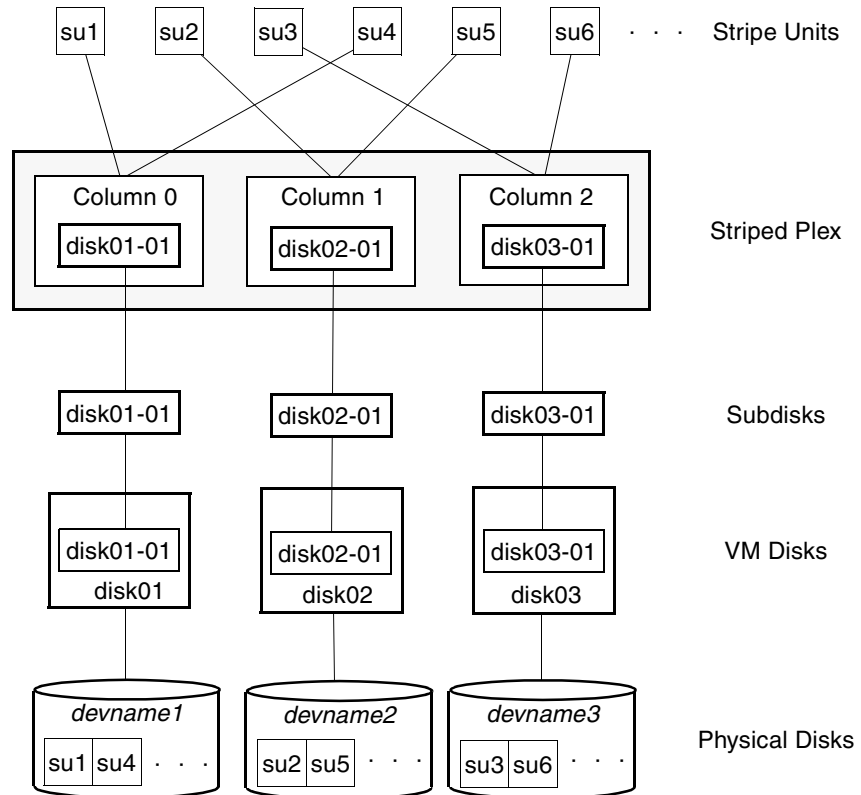

“[Example of a Striped Plex with Concatenated Subdisks per Column](#)” on page 24 illustrates a striped plex with three columns containing subdisks of different sizes. Each column contains a different number of subdisks. There is one column per physical disk. Striped plexes can be created by using a single subdisk from each of the VM disks being striped across. It is also possible to allocate space from different regions of the same disk or from another disk (for example, if the size of the plex is increased). Columns can also contain subdisks from different VM disks.

Example of a Striped Plex with Concatenated Subdisks per Column

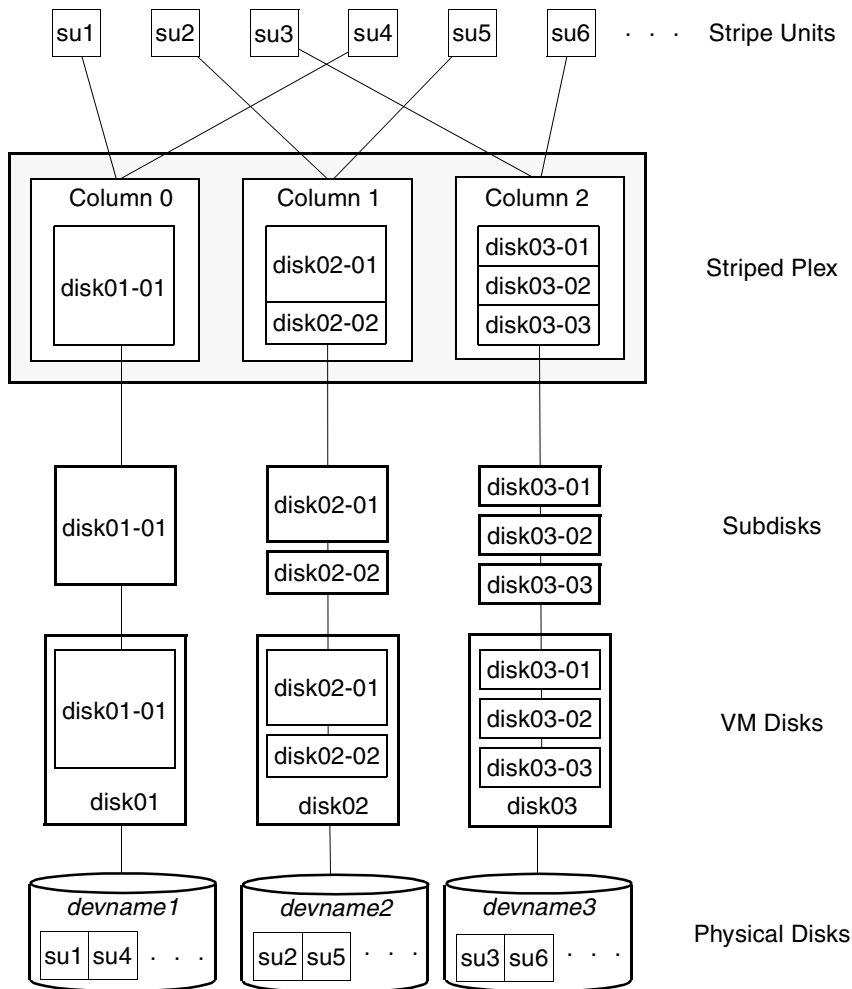

See “[Creating a Striped Volume](#)” on page 214 for information on how to create a striped volume.



Mirroring (RAID-1)

Mirroring uses multiple mirrors (plexes) to duplicate the information contained in a volume. In the event of a physical disk failure, the plex on the failed disk becomes unavailable, but the system continues to operate using the unaffected mirrors.

Note Although a volume can have a single plex, at least two plexes are required to provide redundancy of data. Each of these plexes must contain disk space from *different* disks to achieve redundancy.

When striping or spanning across a large number of disks, failure of any one of those disks can make the entire plex unusable. Because the likelihood of one out of several disks failing is reasonably high, you should consider mirroring to improve the reliability (and availability) of a striped or spanned volume.

See [“Creating a Mirrored Volume”](#) on page 209 for information on how to create a mirrored volume.

Disk duplexing, in which each mirror exists on a separate controller, is also supported. See [“Mirroring across Targets, Controllers or Enclosures”](#) on page 216 for details.

Striping Plus Mirroring (Mirrored-Stripe or RAID-0+1)

Note You need a full license to use this feature.

VxVM supports the combination of mirroring above striping. The combined layout is called a *mirrored-stripe* layout. A mirrored-stripe layout offers the dual benefits of striping to spread data across multiple disks, while mirroring provides redundancy of data.

For mirroring above striping to be effective, the striped plex and its mirrors must be allocated from *separate* disks.

The figure, [“Mirrored-Stripe Volume Laid out on Six Disks”](#) on page 26 shows an example where two plexes, each striped across three disks, are attached as mirrors to the same volume to create a mirrored-stripe volume.



Mirrored-Stripe Volume Laid out on Six Disks

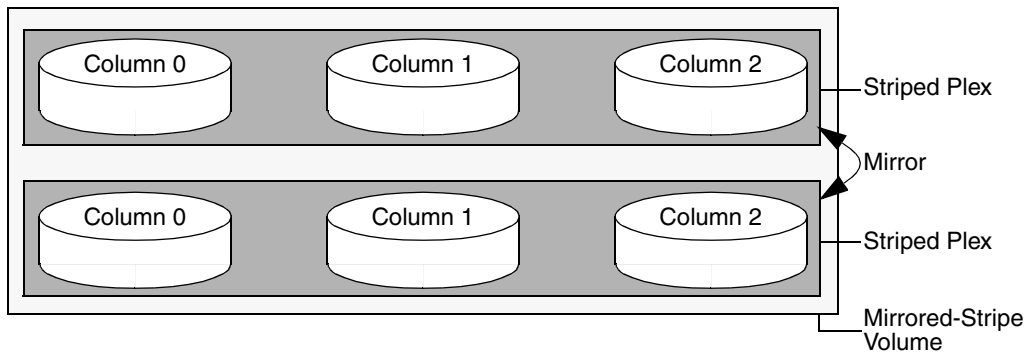

See [“Creating a Mirrored-Stripe Volume”](#) on page 215 for information on how to create a mirrored-stripe volume.

The layout type of the data plexes in a mirror can be concatenated or striped. Even if only one is striped, the volume is still termed a mirrored-stripe volume. If they are all concatenated, the volume is termed a *mirrored-concatenated* volume.

Mirroring Plus Striping (Striped-Mirror, RAID-1+0 or RAID-10)

Note You need a full license to use this feature.

VxVM supports the combination of striping above mirroring. This combined layout is called a *striped-mirror* layout. Putting mirroring below striping mirrors each column of the stripe. If there are multiple subdisks per column, each subdisk can be mirrored individually instead of each column.

Note A striped-mirror volume is an example of a layered volume. See [“Layered Volumes”](#) on page 34 for more information.

As for a mirrored-stripe volume, a striped-mirror volume offers the dual benefits of striping to spread data across multiple disks, while mirroring provides redundancy of data. In addition, it enhances redundancy, and reduces recovery time after disk failure.

[“Striped-Mirror Volume Laid out on Six Disks”](#) on page 27 shows an example where a striped-mirror volume is created by using each of three existing 2-disk mirrored volumes to form a separate column within a striped plex.

Striped-Mirror Volume Laid out on Six Disks

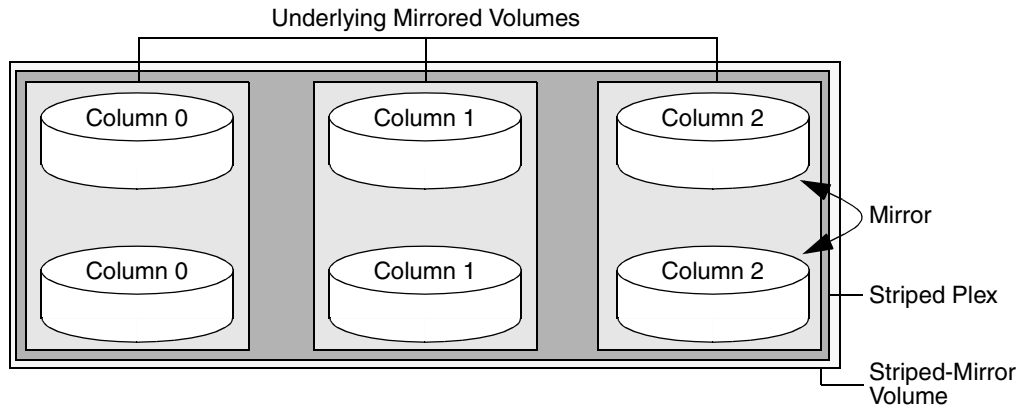

See [“Creating a Striped-Mirror Volume”](#) on page 215 for information on how to create a striped-mirrored volume.

As shown in the figure, [“How the Failure of a Single Disk Affects Mirrored-Stripe and Striped-Mirror Volumes”](#) on page 28, the failure of a disk in a mirrored-stripe layout detaches an entire data plex, thereby losing redundancy on the entire volume. When the disk is replaced, the entire plex must be brought up to date. Recovering the entire plex can take a substantial amount of time. If a disk fails in a striped-mirror layout, only the failing subdisk must be detached, and only that portion of the volume loses redundancy. When the disk is replaced, only a portion of the volume needs to be recovered. Additionally, a mirrored-stripe volume is more vulnerable to being put out of use altogether should a second disk fail before the first failed disk has been replaced, either manually or by hot-relocation.



How the Failure of a Single Disk Affects Mirrored-Stripe and Striped-Mirror Volumes

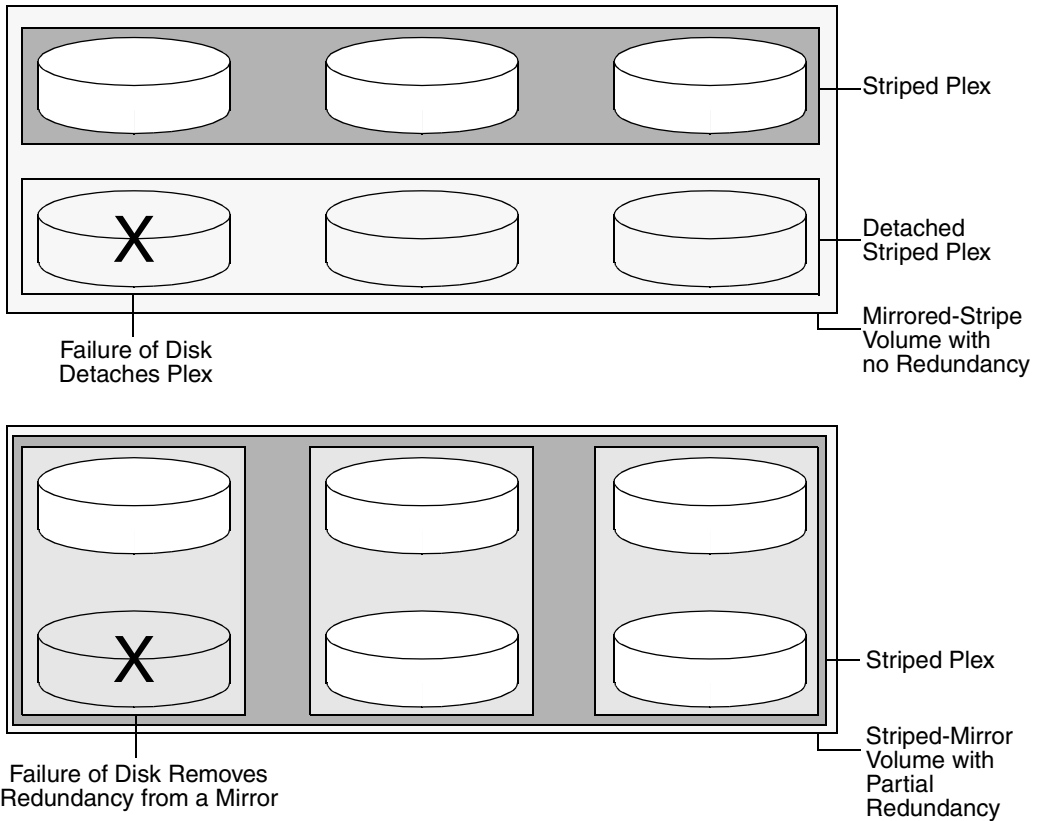

Compared to mirrored-stripe volumes, striped-mirror volumes are more tolerant of disk failure, and recovery time is shorter.

If the layered volume concatenates instead of striping the underlying mirrored volumes, the volume is termed a *concatenated-mirror* volume.



RAID-5 (Striping with Parity)

Note VxVM supports RAID-5 for private disk groups, but not for shareable disk groups in a cluster environment. In addition, VxVM does not support the mirroring of RAID-5 volumes that are configured using VERITAS Volume Manager software. Disk devices that support RAID-5 in hardware may be mirrored.

You need a full license to use this feature.

Although both mirroring (RAID-1) and RAID-5 provide redundancy of data, they use different methods. Mirroring provides data redundancy by maintaining multiple complete copies of the data in a volume. Data being written to a mirrored volume is reflected in all copies. If a portion of a mirrored volume fails, the system continues to use the other copies of the data.

RAID-5 provides data redundancy by using *parity*. Parity is a calculated value used to reconstruct data after a failure. While data is being written to a RAID-5 volume, parity is calculated by doing an exclusive OR (XOR) procedure on the data. The resulting parity is then written to the volume. The data and calculated parity are contained in a plex that is “striped” across multiple disks. If a portion of a RAID-5 volume fails, the data that was on that portion of the failed volume can be recreated from the remaining data and parity information. It is also possible to mix concatenation and striping in the layout.

The figure, “[Parity Locations in a RAID-5 Mode](#)” on page 29, shows parity locations in a RAID-5 array configuration. Every stripe has a column containing a parity stripe unit and columns containing data. The parity is spread over all of the disks in the array, reducing the write time for large independent writes because the writes do not have to wait until a single parity disk can accept the data.

Parity Locations in a RAID-5 Mode

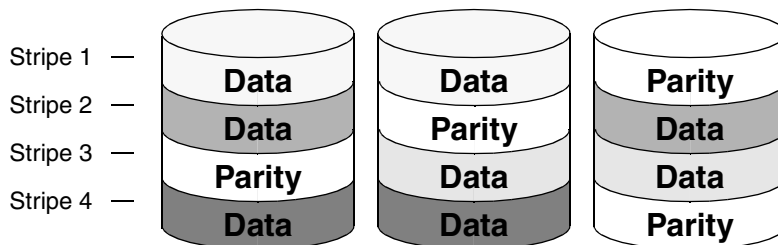

RAID-5 volumes can additionally perform logging to minimize recovery time. RAID-5 volumes use RAID-5 logs to keep a copy of the data and parity currently being written. RAID-5 logging is optional and can be created along with RAID-5 volumes or added later.



The implementation of RAID-5 in VxVM is described in “[VERITAS Volume Manager RAID-5 Arrays](#)” on page 30.

Traditional RAID-5 Arrays

A *traditional* RAID-5 array is several disks organized in rows and columns. A *column* is a number of disks located in the same ordinal position in the array. A *row* is the minimal number of disks necessary to support the full width of a parity stripe. The figure, “[Traditional RAID-5 Array](#),” shows the row and column arrangement of a traditional RAID-5 array.

Traditional RAID-5 Array

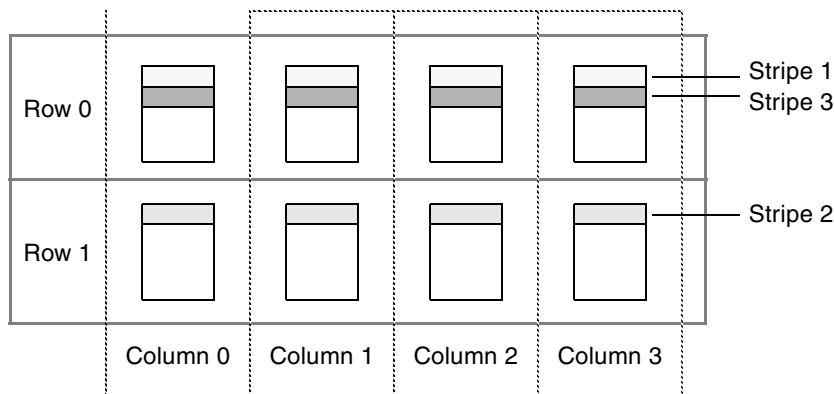

This traditional array structure supports growth by adding more rows per column. Striping is accomplished by applying the first stripe across the disks in Row 0, then the second stripe across the disks in Row 1, then the third stripe across the Row 0 disks, and so on. This type of array requires all disks columns, and rows to be of equal size.

VERITAS Volume Manager RAID-5 Arrays

The RAID-5 array structure in VERITAS Volume Manager differs from the traditional structure. Due to the virtual nature of its disks and other objects, VxVM does not use rows. Instead, VxVM uses columns consisting of variable length subdisks (as shown in “[VERITAS Volume Manager RAID-5 Array](#)” on page 31). Each subdisk represents a specific area of a disk.

VxVM allows each column of a RAID-5 plex to consist of a different number of subdisks. The subdisks in a given column can be derived from different physical disks. Additional subdisks can be added to the columns as necessary. Striping is implemented by applying the first stripe across each subdisk at the top of each column, then applying another stripe

below that, and so on for the length of the columns. Equal-sized stripe units are used for each column. For RAID-5, the default stripe unit size is 16 kilobytes. See “[Striping \(RAID-0\)](#)” on page 21 for further information about stripe units.

VERITAS Volume Manager RAID-5 Array

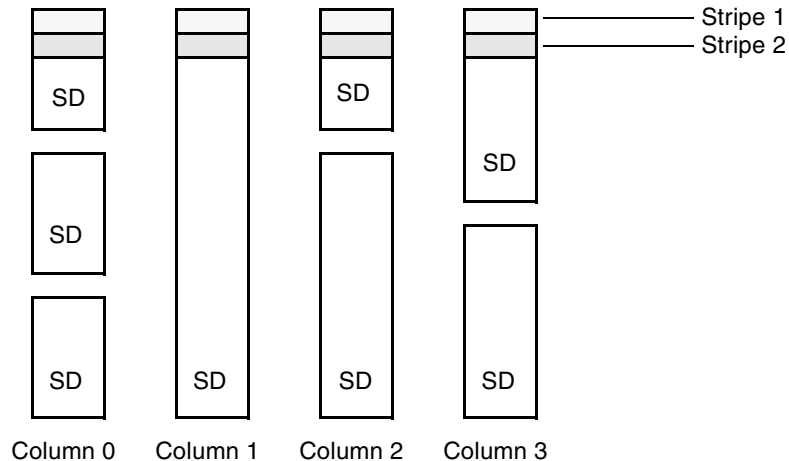

SD = Subdisk

Note Mirroring of RAID-5 volumes is not supported.

See “[Creating a RAID-5 Volume](#)” on page 217 for information on how to create a RAID-5 volume.

Left-Symmetric Layout

There are several layouts for data and parity that can be used in the setup of a RAID-5 array. The implementation of RAID-5 in VxVM uses a left-symmetric layout. This provides optimal performance for both random I/O operations and large sequential I/O operations. However, the layout selection is not as critical for performance as are the number of columns and the stripe unit size.

Left-symmetric layout stripes both data and parity across columns, placing the parity in a different column for every stripe of data. The first parity stripe unit is located in the rightmost column of the first stripe. Each successive parity stripe unit is located in the



next stripe, shifted left one column from the previous parity stripe unit location. If there are more stripes than columns, the parity stripe unit placement begins in the rightmost column again.

The figure, “[Left-Symmetric Layout](#),” shows a left-symmetric parity layout with five disks (one per column).

Left-Symmetric Layout

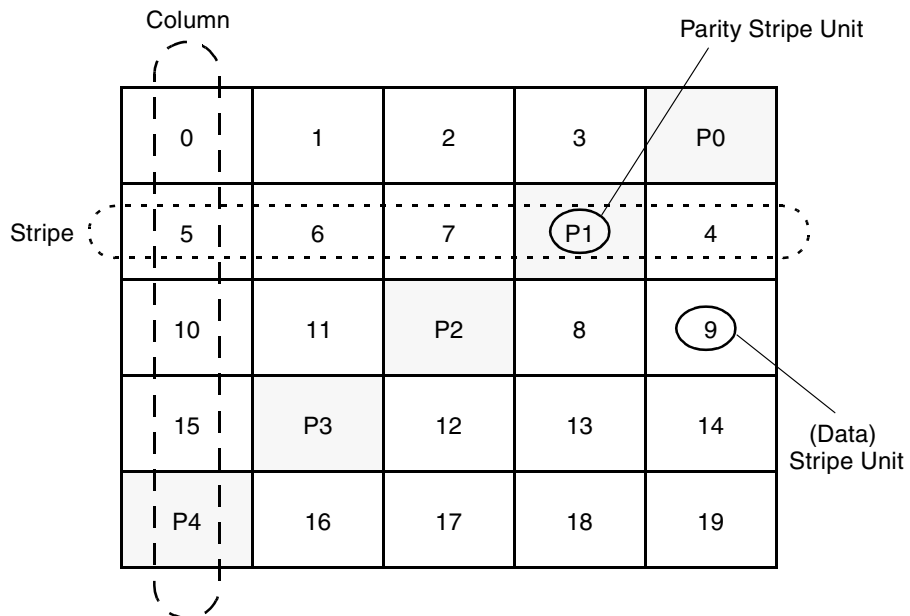

For each stripe, data is organized starting to the right of the parity stripe unit. In the figure, data organization for the first stripe begins at P0 and continues to stripe units 0-3. Data organization for the second stripe begins at P1, then continues to stripe unit 4, and on to stripe units 5-7. Data organization proceeds in this manner for the remaining stripes.

Each parity stripe unit contains the result of an exclusive OR (XOR) operation performed on the data in the data stripe units within the same stripe. If one column's data is inaccessible due to hardware or software failure, the data for each stripe can be restored by XORing the contents of the remaining columns data stripe units against their respective parity stripe units.

For example, if a disk corresponding to the whole or part of the far left column fails, the volume is placed in a degraded mode. While in degraded mode, the data from the failed column can be recreated by XORing stripe units 1-3 against parity stripe unit P0 to recreate stripe unit 0, then XORing stripe units 4, 6, and 7 against parity stripe unit P1 to recreate stripe unit 5, and so on.

Note Failure of more than one column in a RAID-5 plex detaches the volume. The volume is no longer allowed to satisfy read or write requests. Once the failed columns have been recovered, it may be necessary to recover user data from backups.

RAID-5 Logging

Logging is used to prevent corruption of data during recovery by immediately recording changes to data and parity to a log area on a *persistent* device such as a volume on disk or in non-volatile RAM. The new data and parity are then written to the disks.

Without logging, it is possible for data not involved in any active writes to be lost or silently corrupted if both a disk in a RAID-5 volume and the system fail. If this double-failure occurs, there is no way of knowing if the data being written to the data portions of the disks or the parity being written to the parity portions have actually been written. Therefore, the recovery of the corrupted disk may be corrupted itself.

The figure, “[Incomplete Write](#),” illustrates a RAID-5 volume configured across three disks (A, B and C). In this volume, recovery of disk B’s corrupted data depends on disk A’s data and disk C’s parity both being complete. However, only the data write to disk A is complete. The parity write to disk C is incomplete, which would cause the data on disk B to be reconstructed incorrectly.

Incomplete Write

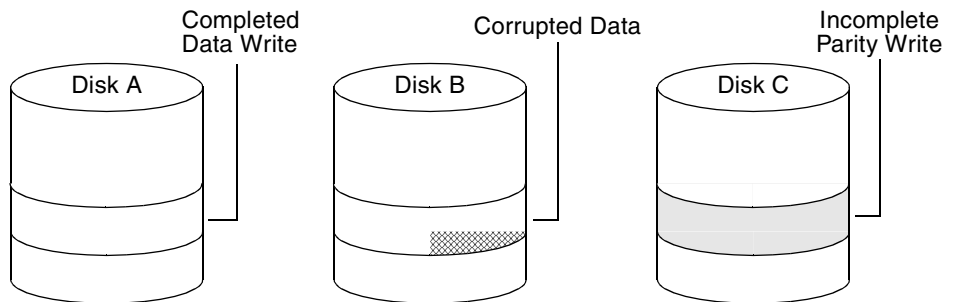

This failure can be avoided by logging all data and parity writes before committing them to the array. In this way, the log can be replayed, causing the data and parity updates to be completed before the reconstruction of the failed drive takes place.

Logs are associated with a RAID-5 volume by being attached as log plexes. More than one log plex can exist for each RAID-5 volume, in which case the log areas are mirrored.

See “[Adding a RAID-5 Log](#)” on page 243 for information on how to add a RAID-5 log to a RAID-5 volume.



Layered Volumes

A *layered volume* is a virtual VERITAS Volume Manager object that is built on top of other volumes. The layered volume structure tolerates failure better and has greater redundancy than the standard volume structure. For example, in a striped-mirror layered volume, each mirror (plex) covers a smaller area of storage space, so recovery is quicker than with a standard mirrored volume.

Example of a Striped-Mirror Layered Volume

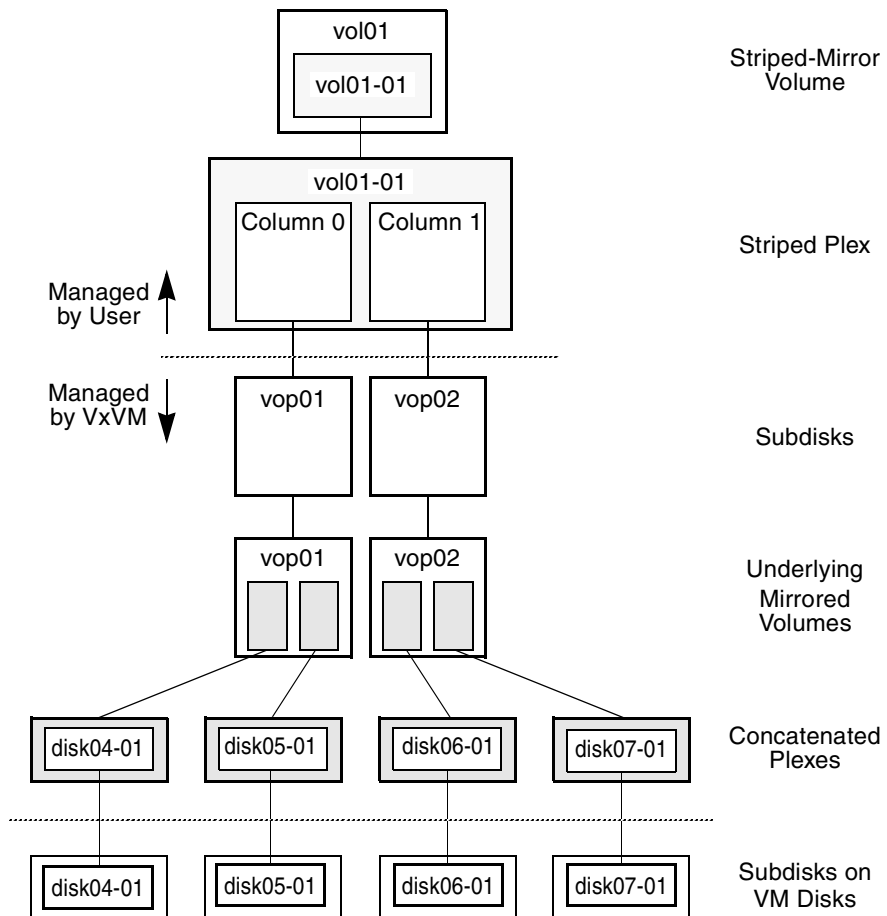

The figure, “[Example of a Striped-Mirror Layered Volume](#)” on page 34, illustrates the structure of a typical layered volume. It shows subdisks with two columns, built on underlying volumes with each volume internally mirrored. The volume and striped plex in the “Managed by User” area allow you to perform normal tasks in VxVM. User tasks can be performed only on the top-level volume of a layered volume.

Underlying volumes in the “Managed by VxVM” area are used exclusively by VxVM and are not designed for user manipulation. You cannot detach a layered volume or perform any other operation on the underlying volumes by manipulating the internal structure. You can perform all necessary operations in the “Managed by User” area that includes the top-level volume and striped plex (for example, resizing the volume, changing the column width, or adding a column).

System administrators can manipulate the layered volume structure for troubleshooting or other operations (for example, to place data on specific disks). Layered volumes are used by VxVM to perform the following tasks and operations:

- ◆ Creating striped-mirrors. (See “[Creating a Striped-Mirror Volume](#)” on page 215, and the `vxassist(1M)` manual page.)
- ◆ Creating concatenated-mirrors. (See “[Creating a Concatenated-Mirror Volume](#)” on page 209, and the `vxassist(1M)` manual page.)
- ◆ Online Relayout. (See “[Online Relayout](#)” on page 36, and the `vxrelayout(1M)` and `vxassist(1M)` manual pages.)
- ◆ RAID-5 subdisk moves. (See the `vxsd(1M)` manual page.)
- ◆ Snapshots. (See “[Administering Volume Snapshots](#)” on page 261, and the `vxsnap(1M)` and `vxassist(1M)` manual pages.)



Online Relayout

Note You need a full license to use this feature.

Online relayout allows you to convert between storage layouts in VxVM, with uninterrupted data access. Typically, you would do this to change the redundancy or performance characteristics of a volume. VxVM adds redundancy to storage either by duplicating the data (mirroring) or by adding parity (RAID-5). Performance characteristics of storage in VxVM can be changed by changing the striping parameters, which are the number of columns and the stripe width.

See “[Performing Online Relayout](#)” on page 254 for details of how to perform online relayout of volumes in VxVM. Also see “[Converting Between Layered and Non-Layered Volumes](#)” on page 260 for information about the additional volume conversion operations that are possible.

How Online Relayout Works

Online relayout allows you to change the storage layouts that you have already created in place without disturbing data access. You can change the performance characteristics of a particular layout to suit your changed requirements. You can transform one layout to another by invoking a single command.

For example, if a striped layout with a 128KB stripe unit size is not providing optimal performance, you can use relayout to change the stripe unit size.

File systems mounted on the volumes do not need to be unmounted to achieve this transformation provided that the file system (such as VERITAS File System™) supports online shrink and grow operations.

Online relayout reuses the existing storage space and has space allocation policies to address the needs of the new layout. The layout transformation process converts a given volume to the destination layout by using minimal temporary space that is available in the disk group.

The transformation is done by moving one portion of data at a time in the source layout to the destination layout. Data is copied from the source volume to the temporary area, and data is removed from the source volume storage area in portions. The source volume storage area is then transformed to the new layout, and the data saved in the temporary area is written back to the new layout. This operation is repeated until all the storage and data in the source volume has been transformed to the new layout.

The default size of the temporary area used during the relayout depends on the size of the volume and the type of relayout. For volumes larger than 50MB, the amount of temporary space that is required is usually 10% of the size of the volume, from a minimum of 50MB up to a maximum of 1GB. For volumes smaller than 50MB, the temporary space required is the same as the size of the volume.

The following error message displays the number of blocks required if there is insufficient free space available in the disk group for the temporary area:

```
tmpsize too small to perform this relayout (nblks minimum required)
```

You can override the default size used for the temporary area by using the `tmpsize` attribute to `vxassist`. See the `vxassist(1M)` manual page for more information.

As well as the temporary area, space is required for a temporary intermediate volume when increasing the column length of a striped volume. The amount of space required is the difference between the column lengths of the target and source volumes. For example, 20GB of temporary additional space is required to relayout a 150GB striped volume with 5 columns of length 30GB as 3 columns of length 50GB. In some cases, the amount of temporary space that is required is relatively large. For example, a relayout of a 150GB striped volume with 5 columns as a concatenated volume (with effectively one column) requires 120GB of space for the intermediate volume.

Additional permanent disk space may be required for the destination volumes, depending on the type of relayout that you are performing. This may happen, for example, if you change the number of columns in a striped volume. The figure, “[Example of Decreasing the Number of Columns in a Volume](#)” on page 37, shows how decreasing the number of columns can require disks to be added to a volume. The size of the volume remains the same but an extra disk is needed to extend one of the columns.

Example of Decreasing the Number of Columns in a Volume

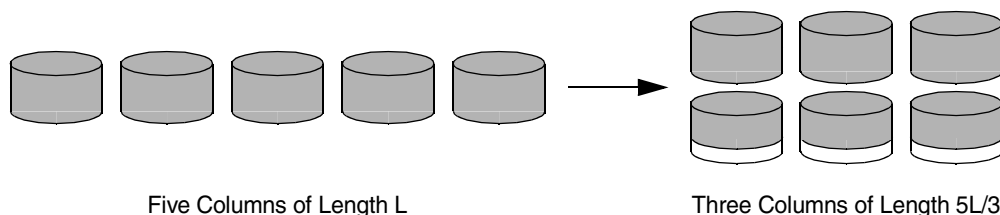

The following are examples of operations that you can perform using online relayout:

- ◆ Change a RAID-5 volume to a concatenated, striped, or layered volume (remove parity). See [“Example of Relayout of a RAID-5 Volume to a Striped Volume”](#) on page 38. Note that removing parity (shown by the shaded area) decreases the overall storage space that the volume requires.

Example of Relayout of a RAID-5 Volume to a Striped Volume

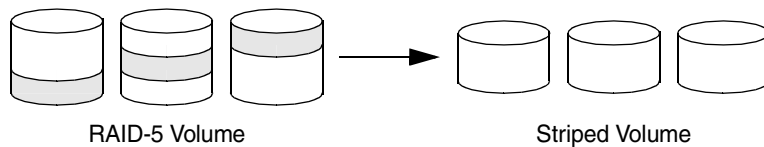

- ◆ Change a volume to a RAID-5 volume (add parity). See [“Example of Relayout of a Concatenated Volume to a RAID-5 Volume”](#) on page 38. Note that adding parity (shown by the shaded area) increases the overall storage space that the volume requires.

Example of Relayout of a Concatenated Volume to a RAID-5 Volume

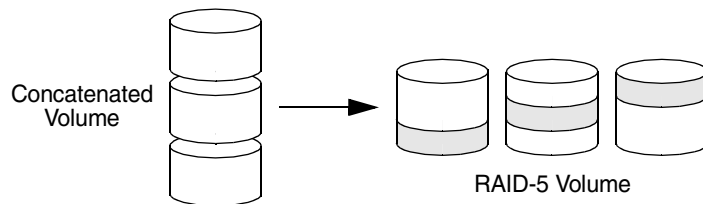

- ◆ Change the number of columns in a volume. See [“Example of Increasing the Number of Columns in a Volume”](#) on page 38. Note that the length of the columns is reduced to conserve the size of the volume.

Example of Increasing the Number of Columns in a Volume

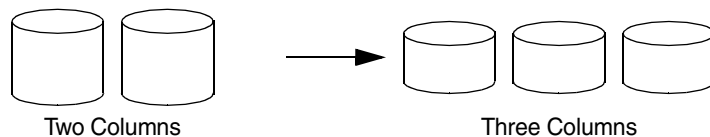

- ◆ Change the column stripe width in a volume. See [“Example of Increasing the Stripe Width for the Columns in a Volume”](#) on page 39.

Example of Increasing the Stripe Width for the Columns in a Volume

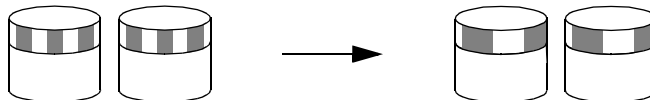

For details of how to perform online relayout operations, see [“Performing Online Relayout”](#) on page 254. For information about the layout transformations that are possible, see [“Permitted Relayout Transformations”](#) on page 255.

Limitations of Online Relayout

Note the following limitations of online relayout:

- ◆ Log plexes cannot be transformed.
- ◆ Volume snapshots cannot be taken when there is an online relayout operation running on the volume.
- ◆ Online relayout cannot create a non-layered mirrored volume in a single step. It always creates a layered mirrored volume even if you specify a non-layered mirrored layout, such as `mirror-stripe` or `mirror-concat`. Use the `vxassist convert` command to turn the layered mirrored volume that results from a relayout into a non-layered volume. See [“Converting Between Layered and Non-Layered Volumes”](#) on page 260 for more information.
- ◆ Online relayout can be used only with volumes that have been created using the `vxassist` command or the VERITAS Enterprise Administrator (VEA).
- ◆ The usual restrictions apply for the minimum number of physical disks that are required to create the destination layout. For example, mirrored volumes require at least as many disks as mirrors, striped and RAID-5 volumes require at least as many disks as columns, and striped-mirror volumes require at least as many disks as columns multiplied by mirrors.
- ◆ To be eligible for layout transformation, the plexes in a mirrored volume must have identical stripe widths and numbers of columns. Relayout is not possible unless you make the layouts of the individual plexes identical.
- ◆ Online relayout involving RAID-5 volumes is not supported for shareable disk groups in a cluster environment.



- ◆ Online relayout cannot transform sparse plexes, nor can it make any plex sparse. (A sparse plex is not the same size as the volume, or has regions that are not mapped to any subdisk.)
- ◆ The number of mirrors in a mirrored volume cannot be changed using relayout.
- ◆ Only one relayout may be applied to a volume at a time.

Transformation Characteristics

Transformation of data from one layout to another involves rearrangement of data in the existing layout to the new layout. During the transformation, online relayout retains data redundancy by mirroring any temporary space used. Read and write access to data is not interrupted during the transformation.

Data is not corrupted if the system fails during a transformation. The transformation continues after the system is restored and both read and write access are maintained.

You can reverse the layout transformation process at any time, but the data may not be returned to the exact previous storage location. Any existing transformation in the volume must be stopped before doing a reversal.

You can determine the transformation direction by using the `vxrelayout status volume` command.

These transformations are protected against I/O failures if there is sufficient redundancy and space to move the data.

Transformations and Volume Length

Some layout transformations can cause the volume length to increase or decrease. If either of these conditions occurs, online relayout uses the `vxresize(1M)` command to shrink or grow a file system as described in [“Resizing a Volume”](#) on page 245.

Volume Resynchronization

When storing data redundantly and using mirrored or RAID-5 volumes, VxVM ensures that all copies of the data match exactly. However, under certain conditions (usually due to complete system failures), some redundant data on a volume can become inconsistent or *unsynchronized*. The mirrored data is not exactly the same as the original data. Except for normal configuration changes (such as detaching and reattaching a plex), this can only occur when a system crashes while data is being written to a volume.

Data is written to the mirrors of a volume in parallel, as is the data and parity in a RAID-5 volume. If a system crash occurs before all the individual writes complete, it is possible for some writes to complete while others do not. This can result in the data becoming unsynchronized. For mirrored volumes, it can cause two reads from the same region of the volume to return different results, if different mirrors are used to satisfy the read request. In the case of RAID-5 volumes, it can lead to parity corruption and incorrect data reconstruction.

VxVM needs to ensure that all mirrors contain exactly the same data and that the data and parity in RAID-5 volumes agree. This process is called *volume resynchronization*. For volumes that are part of the disk group that is automatically imported at boot time (usually aliased as the reserved system-wide disk group, `bootdg`), the resynchronization process takes place when the system reboots.

Not all volumes require resynchronization after a system failure. Volumes that were never written or that were quiescent (that is, had no active I/O) when the system failure occurred could not have had outstanding writes and do not require resynchronization.

Dirty Flags

VxVM records when a volume is first written to and marks it as *dirty*. When a volume is closed by all processes or stopped cleanly by the administrator, and all writes have been completed, VxVM removes the dirty flag for the volume. Only volumes that are marked dirty when the system reboots require resynchronization.

Resynchronization Process

The process of resynchronization depends on the type of volume. RAID-5 volumes that contain RAID-5 logs can “replay” those logs. If no logs are available, the volume is placed in reconstruct-recovery mode and all parity is regenerated. For mirrored volumes, resynchronization is done by placing the volume in recovery mode (also called *read-writeback recovery mode*). Resynchronization of data in the volume is done in the background. This allows the volume to be available for use while recovery is taking place.



The process of resynchronization can impact system performance. The recovery process reduces some of this impact by spreading the recoveries to avoid stressing a specific disk or controller.

For large volumes or for a large number of volumes, the resynchronization process can take time. These effects can be addressed by using dirty region logging (DRL) and FastResync (fast mirror resynchronization) for mirrored volumes, or by ensuring that RAID-5 volumes have valid RAID-5 logs. See the sections “[Dirty Region Logging \(DRL\)](#)” on page 42 and “[FastResync](#)” on page 49 for more information.

For raw volumes used by database applications, the SmartSync Recovery Accelerator can be used if this is supported by the database vendor (see “[SmartSync Recovery Accelerator](#)” on page 44).

Dirty Region Logging (DRL)

Note If a version 20 DCO volume is associated with a volume, a portion of the DCO volume can be used to store the DRL log. There is no need to create a separate DRL log for a volume which has a version 20 DCO volume. For more information, see “[DCO Volume Versioning](#)” on page 51.

You need a full license to use this feature.

Dirty region logging (DRL), if enabled, speeds recovery of mirrored volumes after a system crash. DRL keeps track of the regions that have changed due to I/O writes to a mirrored volume. DRL uses this information to recover only those portions of the volume that need to be recovered.

If DRL is not used and a system failure occurs, all mirrors of the volumes must be restored to a consistent state. Restoration is done by copying the full contents of the volume between its mirrors. This process can be lengthy and I/O intensive. It may also be necessary to recover the areas of volumes that are already consistent.

Dirty Region Logs

DRL logically divides a volume into a set of consecutive regions, and maintains a log on disk where each region is represented by a status bit. This log records regions of a volume for which writes are pending. Before data is written to a region, DRL synchronously marks the corresponding status bit in the log as *dirty*. To enhance performance, the log bit remains set to dirty until the region becomes the least recently accessed for writes. This allows writes to the same region to be written immediately to disk if the region’s log bit is set to dirty.

On restarting a system after a crash, VxVM recovers only those regions of the volume that are marked as dirty in the dirty region log.

Log Subdisks and Plexes

DRL log subdisks store the dirty region log of a mirrored volume that has DRL enabled. A volume with DRL has at least one log subdisk; multiple log subdisks can be used to mirror the dirty region log. Each log subdisk is associated with one plex of the volume. Only one log subdisk can exist per plex. If the plex contains only a log subdisk and no data subdisks, that plex is referred to as a *log plex*.

The log subdisk can also be associated with a regular plex that contains data subdisks. In that case, the log subdisk risks becoming unavailable if the plex must be detached due to the failure of one of its data subdisks.

If the `vxassist` command is used to create a dirty region log, it creates a log plex containing a single log subdisk by default. A dirty region log can also be set up manually by creating a log subdisk and associating it with a plex. The plex then contains both a log and data subdisks.

Sequential DRL

Some volumes, such as those that are used for database replay logs, are written sequentially and do not benefit from delayed cleaning of the DRL bits. For these volumes, *sequential DRL* can be used to limit the number of dirty regions. This allows for faster recovery should a crash occur. However, if applied to volumes that are written to randomly, sequential DRL can be a performance bottleneck as it limits the number of parallel writes that can be carried out.

The maximum number of dirty regions allowed for sequential DRL is controlled by a tunable as detailed in the description of `voldr1_max_seq_dirty` in “[Tunable Parameters](#)” on page 411.

Note DRL adds a small I/O overhead for most write access patterns.

For details of how to configure DRL and sequential DRL, see “[Adding Traditional DRL Logging to a Mirrored Volume](#)” on page 242, and “[Preparing a Volume for DRL and Instant Snapshots](#)” on page 235.



SmartSync Recovery Accelerator

The SmartSync feature of VERITAS Volume Manager increases the availability of mirrored volumes by only resynchronizing changed data. (The process of resynchronizing mirrored databases is also sometimes referred to as *resilvering*.) SmartSync reduces the time required to restore consistency, freeing more I/O bandwidth for business-critical applications. If supported by the database vendor, the SmartSync feature uses an extended interface between VxVM volumes and the database software to avoid unnecessary work during mirror resynchronization. For example, Oracle[®] automatically takes advantage of SmartSync to perform database resynchronization when it is available.

Note SmartSync is only applicable to databases that are configured on raw volumes. You cannot use SmartSync with volumes that contain file systems. Use an alternative solution such as DRL with such volumes.

You must configure volumes correctly to use SmartSync. For VxVM, there are two types of volumes used by the database, as follows:

- ◆ *Redo log volumes* contain redo logs of the database.
- ◆ *Data volumes* are all other volumes used by the database (control files and tablespace files).

SmartSync works with these two types of volumes differently, and they must be configured correctly to take full advantage of the extended interfaces. The only difference between the two types of volumes is that redo log volumes have dirty region logs, while data volumes do not.

To enable the use of SmartSync with database volumes in shared disk groups, set the value of the `volcvm_smartsync` tunable to 1. For a description of `volcvm_smartsync`, see “[Tunable Parameters](#)” on page 411.

Data Volume Configuration

The recovery takes place when the database software is started, not at system startup. This reduces the overall impact of recovery when the system reboots. Because the recovery is controlled by the database, the recovery time for the volume is the resilvering time for the database (that is, the time required to replay the redo logs).

Because the database keeps its own logs, it is not necessary for VxVM to do logging. Data volumes should be configured as mirrored volumes *without* dirty region logs. In addition to improving recovery time, this avoids any run-time I/O overhead due to DRL which improves normal database write access.

Redo Log Volume Configuration

A *redo log* is a log of changes to the database data. Because the database does not maintain changes to the redo logs, it cannot provide information about which sections require resilvering. Redo logs are also written sequentially, and since traditional dirty region logs are most useful with randomly-written data, they are of minimal use for reducing recovery time for redo logs. However, VxVM can reduce the number of dirty regions by modifying the behavior of its Dirty Region Logging feature to take advantage of sequential access patterns. Sequential DRL decreases the amount of data needing recovery and reduces recovery time impact on the system.

The enhanced interfaces for redo logs allow the database software to inform VxVM when a volume is to be used as a redo log. This allows VxVM to modify the DRL behavior of the volume to take advantage of the access patterns. Since the improved recovery time depends on dirty region logs, redo log volumes should be configured as mirrored volumes *with* sequential DRL.

For additional information, see [“Sequential DRL”](#) on page 43.

Volume Snapshots

VERITAS Volume Manager provides the capability for taking an image of a volume at a given point in time. Such an image is referred to as a *volume snapshot*. Such snapshots should not be confused with file system snapshots, which are point-in-time images of a VERITAS File System.

The figure, [“Volume Snapshot as a Point-In-Time Image of a Volume”](#) on page 46, illustrates how a snapshot volume represents a copy of an original volume at a given point in time. Even though the contents of the original volume can change, the snapshot volume can be used to preserve the contents of the original volume as they existed at an earlier time.

The snapshot volume provides a stable and independent base for making backups of the contents of the original volume, or for other applications such as decision support. In the figure, the contents of the snapshot volume are eventually resynchronized with the original volume at a later point in time.

Another possibility is to use the snapshot volume to restore the contents of the original volume. This may be useful if the contents of the original volume have become corrupted in some way.

Note If you choose to write to the snapshot volume, it may no longer be suitable for use in restoring the contents of the original volume.



Volume Snapshot as a Point-In-Time Image of a Volume

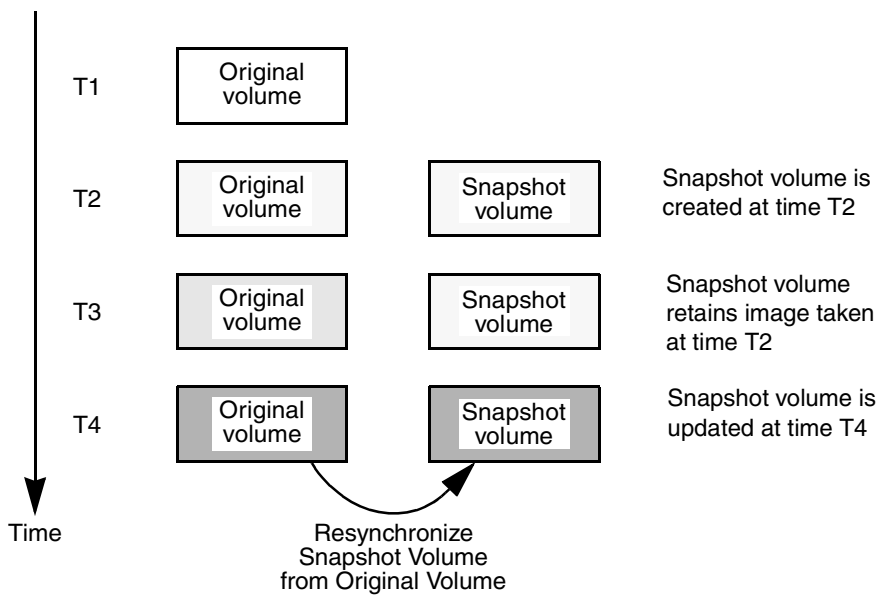

The traditional type of volume snapshot in VxVM is of the *third-mirror break-off* type. This name comes from its implementation where a snapshot plex (or third mirror) is added to a mirrored volume. The contents of the snapshot plex are then synchronized from the original plexes of the volume. When this synchronization is complete, the snapshot plex can be detached as a snapshot volume for use in backup or decision support applications. At a later time, the snapshot plex can be reattached to the original volume, requiring a full resynchronization of the snapshot plex's contents. For more information about this type of snapshot, see "[Traditional Third-Mirror Break-Off Snapshots](#)" on page 263.

The FastResync feature was introduced to track writes to the original volume. This tracking means that only a partial, and therefore much faster, resynchronization is required on reattaching the snapshot plex. In later releases, the snapshot model was enhanced to allow snapshot volumes to contain more than a single plex, reattachment of a subset of a snapshot volume's plexes, and persistence of FastResync across system reboots or cluster restarts.

For more information about FastResync, see "[FastResync](#)" on page 49.

Release 4.0 of VxVM introduced full-sized instant snapshots and space-optimized instant snapshots, which offer advantages over traditional third-mirror snapshots such as immediate availability and easier configuration and administration. You can also use a third-mirror break-off usage model with full-sized snapshots, where this is necessary for write-intensive applications.

For more information, see the following sections:

- ◆ [“Full-Sized Instant Snapshots”](#) on page 265.
- ◆ [“Space-Optimized Instant Snapshots”](#) on page 267.
- ◆ [“Emulation of Third-Mirror Break-Off Snapshots”](#) on page 268.

[“Comparison of Snapshot Features”](#) on page 47 compares the features that are supported by the three different types of snapshot.

For more information about taking snapshots of a volume, see [“Administering Volume Snapshots”](#) on page 261, and the `vxsnap(1M)` and `vxassist(1M)` manual pages.

Comparison of Snapshot Features

The table, [“Comparison of Snapshot Features for Supported Snapshot Types”](#) on page 48, compares the features of the various types of snapshots that are supported in VxVM.

Full-sized instant snapshots are easier to configure and offer more flexibility of use than do traditional third-mirror break-off snapshots. For preference, new volumes should be configured to use snapshots that have been created using the `vxsnap` command rather than using the `vxassist` command. Legacy volumes can also be reconfigured to use `vxsnap` snapshots, but this requires rewriting of administration scripts that assume the `vxassist` snapshot model.

If storage space is at a premium, space-optimized instant snapshots can be configured with some reduction of supported functionality. For example, space-optimized snapshots cannot be turned into independent volumes, nor can they be moved into a separate disk group for off-host processing.



Comparison of Snapshot Features for Supported Snapshot Types

Snapshot Feature	Third-Mirror Break-Off (vxassist or vxsnap)	Full-Sized Instant (vxsnap)	Space-Optimized Instant (vxsnap)
Immediately available for use on creation	No	Yes	Yes
Requires less storage space than original volume	No	No	Yes
Can be reattached to original volume	Yes	Yes	No
Can be used to restore contents of original volume	Yes ¹	Yes ¹	Yes ²
Can quickly be refreshed without being reattached	No	Yes	Yes
Snapshot hierarchy can be split	No	Yes ³	No
Can be moved into separate disk group from original volume	Yes	Yes ³	No
Can be turned into an independent volume	Yes	Yes ³	No
FastResync ability persists across system reboots or cluster restarts	Yes ⁴	Yes	Yes
Synchronization can be controlled	No	Yes	No

1 If vxsnap is used, the snapshot can be selectively removed following restoration of the original volume.

2 Restoration does not remove the snapshot.

3 Synchronization of the snapshot volume must be complete.

4 Persistent FastResync must have been enabled.



FastResync

Note You need a VERITAS FlashSnap™ or FastResync license to use this feature.

The FastResync feature (previously called Fast Mirror Resynchronization or FMR) performs quick and efficient resynchronization of stale mirrors (a mirror that is not synchronized). This increases the efficiency of the VxVM snapshot mechanism, and improves the performance of operations such as backup and decision support applications. Typically, these operations require that the volume is quiescent, and that they are not impeded by updates to the volume by other activities on the system. To achieve these goals, the snapshot mechanism in VxVM creates an exact copy of a primary volume at an instant in time. After a snapshot is taken, it can be accessed independently of the volume from which it was taken. In a clustered VxVM environment with shared access to storage, it is possible to eliminate the resource contention and performance overhead of using a snapshot simply by accessing it from a different node.

For details of how to enable FastResync on a per-volume basis, see [“Enabling FastResync on a Volume”](#) on page 252.

FastResync Enhancements

FastResync provides two fundamental enhancements to VxVM:

- ◆ FastResync optimizes mirror resynchronization by keeping track of updates to stored data that have been missed by a mirror. (A mirror may be unavailable because it has been *detached* from its volume, either automatically by VxVM as the result of an error, or directly by an administrator using a utility such as `vxplex` or `vxassist`. A *returning mirror* is a mirror that was previously detached and is in the process of being re-attached to its original volume as the result of the `vxrecover` or `vxplex att` operation.) When a mirror returns to service, only the updates that it has missed need to be re-applied to resynchronize it. This requires much less effort than the traditional method of copying all the stored data to the returning mirror.

Once FastResync has been enabled on a volume, it does not alter how you administer mirrors. The only visible effect is that repair operations conclude more quickly.

- ◆ FastResync allows you to refresh and re-use snapshots rather than discard them. You can quickly re-associate (*snapback*) snapshot plexes with their original volumes. This reduces the system overhead required to perform cyclical operations such as backups that rely on the snapshot functionality of VxVM.



Non-Persistent FastResync

Non-Persistent FastResync allocates its change maps in memory. If Non-Persistent FastResync is enabled, a separate FastResync map is kept for the original volume and for each snapshot volume. Unlike a dirty region log (DRL), they do not reside on disk nor in persistent store. This has the advantage that updates to the FastResync map have little impact on I/O performance, as no disk updates needed to be performed. However, if a system is rebooted, the information in the map is lost, so a full resynchronization is required on snapback. This limitation can be overcome for volumes in cluster-shareable disk groups, provided that at least one of the nodes in the cluster remained running to preserve the FastResync map in its memory. However, a node crash in a High Availability (HA) environment requires the full resynchronization of a mirror when it is reattached to its parent volume.

How Non-Persistent FastResync Works with Snapshots

The snapshot feature of VxVM takes advantage of FastResync change tracking to record updates to the original volume after a snapshot plex is created. After a snapshot is taken, the `snapback` option is used to reattach the snapshot plex. Provided that FastResync is enabled on a volume before the snapshot is taken, and that it is not disabled at any time before the snapshot is reattached, the changes that FastResync records are used to resynchronize the volume during the snapback. This considerably reduces the time needed to resynchronize the volume.

Non-Persistent FastResync uses a map in memory to implement change tracking. Each bit in the map represents a contiguous number of blocks in a volume's address space. The default size of the map is 4 blocks. The kernel tunable `vol_fmr_logsz` can be used to limit the maximum size in blocks of the map as described on "[Tunable Parameters](#)" on page 411.

Persistent FastResync

Unlike Non-Persistent FastResync, Persistent FastResync keeps the FastResync maps on disk so that they can survive system reboots, system crashes and cluster crashes. Persistent FastResync can also track the association between volumes and their snapshot volumes after they are moved into different disk groups. When the disk groups are rejoined, this allows the snapshot plexes to be quickly resynchronized. This ability is not supported by Non-Persistent FastResync. See "[Reorganizing the Contents of Disk Groups](#)" on page 155 for details.

If Persistent FastResync is enabled on a volume or on a snapshot volume, a *data change object* (DCO) and a *DCO volume* are associated with the volume.

DCO Volume Versioning

The internal layout of the DCO volume changed in VxVM 4.0 to support new features such as full-sized and space-optimized instant snapshots. Because the DCO volume layout is versioned, VxVM software continues to support the version 0 layout for legacy volumes. However, you must configure a volume to have a version 20 DCO volume if you want to take instant snapshots of the volume. Future releases of VERITAS Volume Manager may introduce new versions of the DCO volume layout.

See “[Determining the DCO Version Number](#)” on page 238 for a description of how to find out the version number of a DCO that is associated with a volume.

Version 0 DCO Volume Layout

In VxVM releases 3.2 and 3.5, the DCO object only managed information about the FastResync maps. These maps track writes to the original volume and to each of up to 32 snapshot volumes since the last snapshot operation. Each plex of the DCO volume on disk holds 33 maps, each of which is 4 blocks in size by default.

Persistent FastResync uses the maps in a version 0 DCO volume on disk to implement change tracking. As for Non-Persistent FastResync, each bit in the map represents a *region* (a contiguous number of blocks) in a volume’s address space. The size of each map can be changed by specifying the `dcolen` attribute to the `vxassist` command when the volume is created. The default value of `dcolen` is 132 1024-byte blocks (the plex contains 33 maps, each of length 4 blocks). To use a larger map size, multiply the desired map size by 33 to calculate the value of `dcolen` that you need to specify. For example, to use an 8-block map, you would specify `dcolen=264`. The maximum possible map size is 64 blocks, which corresponds to a `dcolen` value of 2112 blocks.

Note The size of a DCO plex is rounded up to the nearest integer multiple of the disk group alignment value. The alignment value is 8KB for disk groups that support the Cross-platform Data Sharing (CDS) feature. Otherwise, the alignment value is 1 block.

Only traditional (third-mirror) volume snapshots that are administered using the `vxassist` command are supported for the version 0 DCO volume layout. Full-sized and space-optimized instant snapshots are not supported.

Version 20 DCO Volume Layout

In VxVM 4.0 and later releases, the DCO object is used not only to manage the FastResync maps, but also to manage DRL recovery maps (see “[Dirty Region Logging \(DRL\)](#)” on page 42) and special maps called *copymaps* that allow instant snapshot operations to resume correctly following a system crash.



Each bit in a map represents a *region* (a contiguous number of blocks) in a volume's address space. A region represents the smallest portion of a volume for which changes are recorded in a map. A write to a single byte of storage anywhere within a region is treated in the same way as a write to the entire region.

The layout of a version 20 DCO volume includes an accumulator that stores the DRL map and a per-region state map for the volume, plus 32 per-volume maps (by default) including a DRL recovery map, and a map for tracking detaches that are initiated by the kernel due to I/O error. The remaining 30 per-volume maps (by default) are used either for tracking writes to snapshots, or as copymaps. The size of the DCO volume is determined by the size of the regions that are tracked, and by the number of per-volume maps. Both the region size and the number of per-volume maps in a DCO volume may be configured when a volume is prepared for use with snapshots. The region size must be a power of 2 and be greater than or equal to 16KB.

As the accumulator is approximately 3 times the size of a per-volume map, the size of each plex in the DCO volume can be estimated from this formula:

$$DCO_plex_size = (3 + number_of_per_volume_maps) * map_size$$

where the size of each map in bytes is:

$$map_size = 512 + (volume_size / (region_size * 8))$$

rounded up to the nearest multiple of 8KB. Note that each map includes a 512-byte header.

For the default number of 32 per-volume maps and region size of 64KB, a 10GB volume requires a map size of 24KB, and so each plex in the DCO volume requires 840KB of storage.

Note Full-sized and space-optimized instant snapshots, which are administered using the `vxsnap` command, are supported for a version 20 DCO volume layout. The use of the `vxassist` command to administer traditional (third-mirror break-off) snapshots is not supported for a version 20 DCO volume layout.

How Persistent FastResync Works with Snapshots

Persistent FastResync uses a map in a DCO volume on disk to implement change tracking. As for Non-Persistent FastResync, each bit in the map represents a contiguous number of blocks in a volume's address space.

“[Mirrored Volume with Persistent FastResync Enabled](#)” on page 53 shows an example of a mirrored volume with two plexes on which Persistent FastResync is enabled. Associated with the volume are a DCO object and a DCO volume with two plexes.

Mirrored Volume with Persistent FastResync Enabled

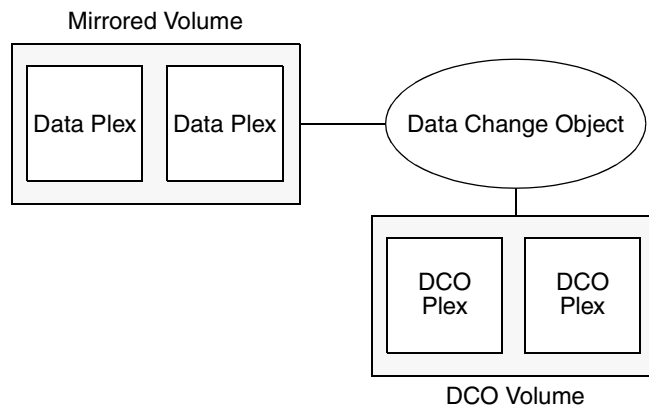

To create a traditional third-mirror snapshot or an instant (copy-on-write) snapshot, the `vxassist snapstart` or `vxsnap make` operation respectively is performed on the volume. This sets up a snapshot plex in the volume and associates a disabled DCO plex with it, as shown in “[Mirrored Volume After Completion of a snapstart Operation](#)” on page 54.



Mirrored Volume After Completion of a snapstart Operation

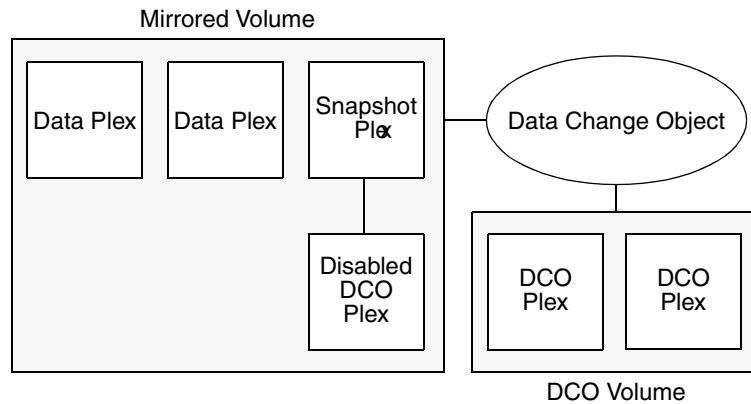

Multiple snapshot plexes and associated DCO plexes may be created in the volume by re-running the `vxassist snapstart` command for traditional snapshots, or the `vxsnap make` command for space-optimized snapshots. You can create up to a total of 32 plexes (data and log) in a volume.

Note Space-optimized instant snapshots do not require additional full-sized plexes to be created. Instead, they use a storage cache that typically requires only 10% of the storage that is required by full-sized snapshots. There is a trade-off in functionality in using space-optimized snapshots as described in “[Comparison of Snapshot Features](#)” on page 47. The storage cache is formed within a cache volume, and this volume is associated with a cache object. For convenience of operation, this cache can be shared by all the instant space-optimized snapshots within a disk group.

A traditional snapshot volume is created from a snapshot plex by running the `vxassist snapshot` operation on the volume. For instant snapshots, however, the `vxsnap make` command makes an instant snapshot volume immediately available for use. There is no need to run an additional command.

As illustrated in “[Mirrored Volume and Snapshot Volume After Completion of a snapshot Operation](#)” on page 56, creation of the snapshot volume also sets up a DCO object and a DCO volume for the snapshot volume. This DCO volume contains the single DCO plex that was associated with the snapshot plex. If two snapshot plexes were taken to form the snapshot volume, the DCO volume would contain two plexes. For instant space-optimized snapshots, the DCO object and DCO volume are associated with a snapshot volume that is created on a cache object and not on a VM disk.

Associated with both the original volume and the snapshot volume are *snap objects*. The snap object for the original volume points to the snapshot volume, and the snap object for the snapshot volume points to the original volume. This allows VxVM to track the relationship between volumes and their snapshots even if they are moved into different disk groups.

The snap objects in the original volume and snapshot volume are automatically deleted in the following circumstances:

- ◆ For traditional snapshots, the `vxassist snapback` operation is run to return all of the plexes of the snapshot volume to the original volume.
- ◆ For traditional snapshots, the `vxassist snapclear` operation is run on a volume to break the association between the original volume and the snapshot volume. If the volumes are in different disk groups, the command must be run separately on each volume.
- ◆ For full-sized instant snapshots, the `vxsnap reattach` operation is run to return all of the plexes of the snapshot volume to the original volume.
- ◆ For full-sized instant snapshots, the `vxsnap dis` or `vxsnap split` operations are run on a volume to break the association between the original volume and the snapshot volume. If the volumes are in different disk groups, the command must be run separately on each volume.

Note The `vxsnap reattach`, `dis` and `split` operations are not supported for instant space-optimized snapshots.

See “[Administering Volume Snapshots](#)” on page 261, and the `vxsnap(1M)` and `vxassist(1M)` manual pages for more information.

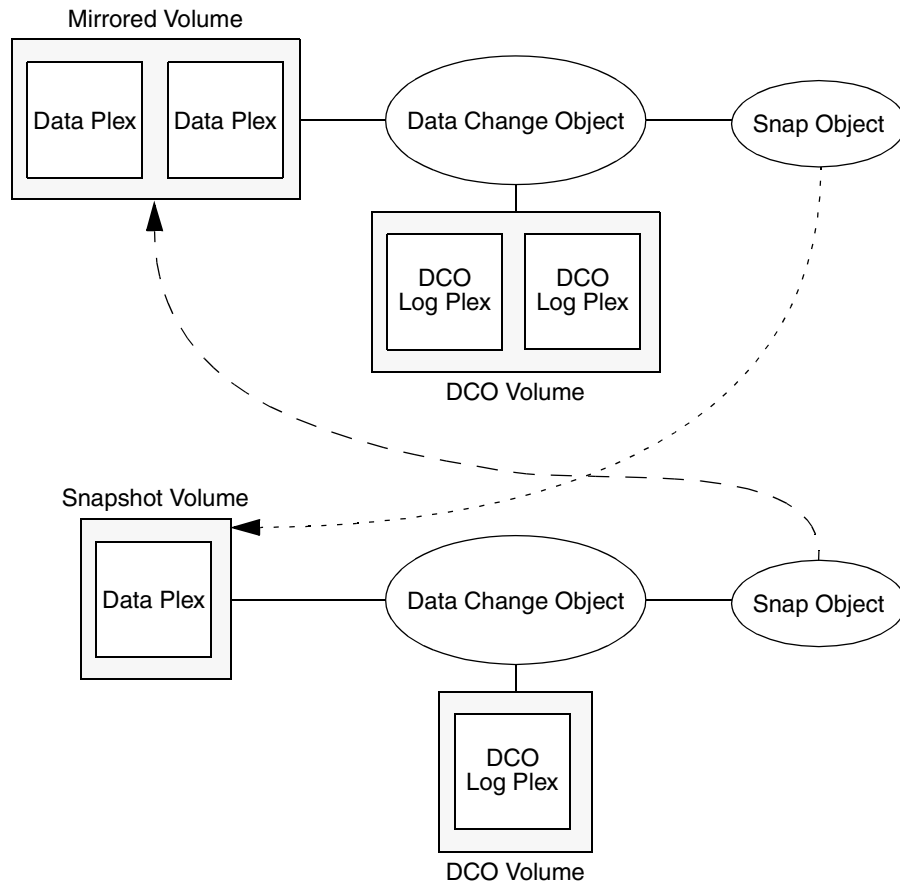

Mirrored Volume and Snapshot Volume After Completion of a snapshot Operation

**Effect of Growing a Volume on the FastResync Map**

It is possible to grow the replica volume, or the original volume, and still use FastResync. According to the DCO volume layout, growing the volume has different effects on the map that FastResync uses to track changes to the original volume:

- ◆ For a version 20 DCO volume, the size of the map is increased and the size of the region that is tracked by each bit in the map stays the same.
- ◆ For a version 0 DCO volume, the size of the map remains the same and the region size is increased.

In either case, the part of the map that corresponds to the grown area of the volume is marked as “dirty” so that this area is resynchronized. The `snapback` operation fails if it attempts to create an incomplete snapshot plex. In such cases, you must grow the replica volume, or the original volume, before invoking any of the commands `vxsnap reattach`, `vxsnap restore`, or `vxassist snapback`. Growing the two volumes separately can lead to a snapshot that shares physical disks with another mirror in the volume. To prevent this, grow the volume after the `snapback` command is complete.

FastResync Limitations

The following limitations apply to FastResync:

- ◆ Persistent FastResync is supported for RAID-5 volumes, but this prevents the use of the relayout or resize operations on the volume while a DCO is associated with it.
- ◆ Neither Non-Persistent nor Persistent FastResync can be used to resynchronize mirrors after a system crash. Dirty region logging (DRL), which can coexist with FastResync, should be used for this purpose. In VxVM 4.0 and later releases, DRL logs may be stored in a version 20 DCO volume.
- ◆ When a subdisk is relocated, the entire plex is marked “dirty” and a full resynchronization becomes necessary.
- ◆ If a snapshot volume is split off into another disk group, Non-Persistent FastResync cannot be used to resynchronize the snapshot plexes with the original volume when the disk group is rejoined with the original volume’s disk group. Persistent FastResync must be used for this purpose.
- ◆ If you move or split an original volume (on which Persistent FastResync is enabled) into another disk group, and then move or join it to a snapshot volume’s disk group, you cannot use `vxassist snapback` to resynchronize traditional snapshot plexes with the original volume. This restriction arises because a snapshot volume references the original volume by its record ID at the time that the snapshot volume was created. Moving the original volume to a different disk group changes the volume’s record ID, and so breaks the association. However, in such a case, you can use the `vxplex snapback` command with the `-f` (force) option to perform the `snapback`.

Note This restriction only applies to traditional snapshots. It does not apply to instant snapshots.

- ◆ Any operation that changes the layout of a replica volume can mark the FastResync change map for that snapshot “dirty” and require a full resynchronization during `snapback`. Operations that cause this include subdisk split, subdisk move, and online relayout of the replica. It is safe to perform these operations after the snapshot is completed. For more information, see the `vxvol` (1M), `vxassist` (1M), and `vxplex` (1M) manual pages.



Hot-Relocation

Note You need a full license to use this feature.

Hot-relocation is a feature that allows a system to react automatically to I/O failures on redundant objects (mirrored or RAID-5 volumes) in VxVM and restore redundancy and access to those objects. VxVM detects I/O failures on objects and relocates the affected subdisks. The subdisks are relocated to disks designated as *spare disks* and/or free space within the disk group. VxVM then reconstructs the objects that existed before the failure and makes them accessible again.

When a partial disk failure occurs (that is, a failure affecting only some subdisks on a disk), redundant data on the failed portion of the disk is relocated. Existing volumes on the unaffected portions of the disk remain accessible. For further details, see [“Administering Hot-Relocation”](#) on page 327.

Volume Sets

Note You need a full license to use this feature.

Volume sets are an enhancement to VxVM that allow several volumes to be represented by a single logical object. All I/O from and to the underlying volumes is directed via the I/O interfaces of the volume set. The volume set feature supports the multi-device enhancement to VERITAS File System (VxFS). This feature allows file systems to make best use of the different performance and availability characteristics of the underlying volumes. For example, file system metadata could be stored on volumes with higher redundancy, and user data on volumes with better performance.

For more information about creating and administering volume sets, see [“Creating and Administering Volume Sets”](#) on page 311.



Administering Disks

2

This chapter describes the operations for managing disks used by the VERITAS Volume Manager (VxVM). This includes placing disks under VxVM control, initializing disks, mirroring the root disk, and removing and replacing disks.

Note Most VxVM commands require superuser or equivalent privileges.

Disks that are controlled by the LVM subsystem cannot be used directly as VxVM disks, but they can be converted so that their volume groups and logical volumes become VxVM disk groups and volumes. For more information on conversion, see the *VERITAS Volume Manager Migration Guide*.

For information about configuring and administering the Dynamic Multipathing (DMP) feature of VxVM that is used with multiported disk arrays, see “[Administering Dynamic Multipathing \(DMP\)](#)” on page 101.

Disk Devices

When performing disk administration, it is important to understand the difference between a *disk name* and a *device name*.

When a disk is placed under VxVM control, a VM disk is assigned to it. You can define a symbolic *disk name* (also known as a *disk media name*) to refer to a VM disk for the purposes of administration. A disk name can be up to 31 characters long. If you do not assign a disk name, it defaults to *diskgroup##* where *diskgroup* is the name of the disk group to which the disk is being added, and *##* is a sequence number. Your system may use device names that differ from those given in the examples.

The *device name* (sometimes referred to as *devname* or *disk access name*) defines the name of a disk device as it is known to the operating system. Such devices are usually, but not always, located in the `/dev/[r]disk` directories. Devices that are specific to hardware from certain vendors may use their own path name conventions.

VxVM recreates disk devices, including those from the `/dev/[r]disk` directories, as *metadevices* in the `/dev/vx/[r]dmp` directories. The dynamic multipathing (DMP) feature of VxVM uses these metadevices (or *DMP nodes*) to represent disks that can be



accessed by more than one physical path, usually via different controllers. The number of access paths that are available depends on whether the disk is a single disk, or is part of a multiported disk array that is connected to a system.

You can use the `vxdisk` utility to display the paths subsumed by a metadvice, and to display the status of each path (for example, whether it is enabled or disabled). For more information, see “[Administering Dynamic Multipathing \(DMP\)](#)” on page 101.

Device names may also be remapped as enclosure-based names as described in the following section.

Disk Device Naming in VxVM

Prior to VxVM 3.2, all disks were named according to the `c##t##d#` naming format used by the operating system. Fabric mode disks were not supported by VxVM. From VxVM 3.2 onward, there are two different methods of naming disk devices:

- ◆ [c##t##d# Based Naming](#)
- ◆ [Enclosure Based Naming](#)

c##t##d# Based Naming

In this naming scheme, all disk devices except fabric mode disks are named using the `c##t##d#` format.

The syntax of a device name is `c##t##d#`, where `c#` represents a controller on a host bus adapter, `t#` is the target controller ID, and `d#` identifies a disk on the target controller.

Fabric mode disk devices are named as follows:

- ◆ Disk in supported disk arrays are named using the *enclosure name_#* format. For example, disks in the supported disk array name `FirstFloor` are named `FirstFloor_0`, `FirstFloor_1`, `FirstFloor_2` and so on. (You can use the `vxdmppadm` command to administer enclosure names.)
- ◆ Disks in the `DISKS` category (JBOD disks) are named using the `Disk_#` format.
- ◆ Disks in the `OTHER_DISKS` category (disks that are not multipathed by DMP) are named using the `fabric_#` format.

Enclosure Based Naming

Enclosure-based naming operates as follows:

- ◆ Devices with very long device names (for example, Fibre Channel devices that include worldwide name (WWN) identifiers) are always represented by enclosure-based names.

- ◆ All fabric or non-fabric disks in supported disk arrays are named using the *enclosure_name_#* format. For example, disks in the supported disk array, *enggddept* are named *enggddept_0*, *enggddept_1*, *enggddept_2* and so on. (You can use the `vxddmpadm` command to administer enclosure names. See “[Administering DMP Using vxddmpadm](#)” on page 111 and the `vxddmpadm(1M)` manual page for more information.)
- ◆ Disks in the `DISKS` category (JBOD disks) are named using the `Disk_#` format.
- ◆ Disks in the `OTHER_DISKS` category (disks that are not multipathed by DMP) are named as follows:
 - ◆ Non-fabric disks are named using the `c#t#d#` format.
 - ◆ Fabric disks are named using the `fabric_#` format.

See “[Changing the Disk-Naming Scheme](#)” on page 72 for details of how to switch between the two naming schemes.

To display the native OS device names of a VM disk (such as `mydg01`), use the following command:

```
# vxddisk path | egrep diskname
```

For information on how to rename an enclosure, see “[Renaming an Enclosure](#)” on page 126.

For a description of disk categories, see “[Disk Categories](#)” on page 64.

Private and Public Disk Regions

Most VM disks have two regions:

private region A small area where configuration information is stored. A disk header label, configuration records for VxVM objects (such as volumes, plexes and subdisks), and an intent log for the configuration database are stored here. The default private region size is 2048 blocks (2048 kilobytes), which is large enough to record the details of about 4000 VxVM objects in a disk group.

Under most circumstances, the default private region size should be sufficient. For administrative purposes, it is usually much simpler to create more disk groups that contain fewer volumes, or to split large disk groups into several smaller ones (as described in “[Splitting Disk Groups](#)” on page 165). If required, the value for the private region size may be overridden when you add or replace a disk using the `vxddiskadm` command.



Each disk that has a private region holds an entire copy of the configuration database for the disk group. The size of the configuration database for a disk group is limited by the size of the *smallest* copy of the configuration database on any of its member disks.

public region An area that covers the remainder of the disk, and which is used for the allocation of storage space to subdisks.

A disk's type identifies how VxVM accesses a disk, and how it manages the disk's private and public regions. The following disk access types are used by VxVM:

simple The public and private regions are on the same disk area (with the public area following the private area).

nopriv There is no private region (only a public region for allocating subdisks). This is the simplest disk type consisting only of space for allocating subdisks. Such disks are most useful for defining special devices (such as RAM disks, if supported) on which private region data would not persist between reboots. They can also be used to encapsulate disks where there is insufficient room for a private region. The disks cannot store configuration and log copies, and they do not support the use of the `vxdisk addregion` command to define reserved regions. VxVM cannot track the movement of *nopriv* disks on a SCSI chain or between controllers.

auto When the `vxconfigd` daemon is started, VxVM obtains a list of known disk device addresses from the operating system and configures disk access records for them automatically.

Auto-configured disks (with disk access type *auto*) support the following disk formats:

cdsdisk The disk is formatted as a Cross-platform Data Sharing (CDS) disk that is suitable for moving between different operating systems. This is the default format for disks that are not used to boot the system. Typically, most disks on a system are configured as this disk type. However, it is not a suitable format for boot, root or swap disks, for mirrors or hot-relocation spares of such disks, or for EFI disks.

hpdisk The disk is formatted as a simple disk. This format can be applied to disks that are used to boot the system. The disk can be converted to a CDS disk if it was not initialized for use as a boot disk.

See the `vxcdsconvert(1M)` manual page for information about the utility that you can use to convert disks to the *cdsdisk* format.

By default, auto-configured disks are formatted as *cdsdisk* disks when they are initialized for use with VxVM. You can change the default format by using the `vxdiskadm(1M)` command to update the `/etc/default/vxdisk` defaults file as

described in “[Displaying and Changing Default Disk Layout Attributes](#)” on page 77. See the `vxdisk(1M)` manual page for details of the usage of this file, and for more information about disk types and their configuration.

Discovering and Configuring Newly Added Disk Devices

When you physically connect new disks to a host or when you zone new fibre channel devices to a host, you can use the `vxctl` command to rebuild the volume device node directories and to update the DMP internal database to reflect the new state of the system.

To reconfigure the DMP database, first run `ioscan` followed by `insf` to make the operating system recognize the new disks, and then invoke the `vxctl enable` command. See the `vxctl(1M)` manual page for more information.

You can also use the `vxdisk scandisks` command to scan devices in the operating system device tree and to initiate dynamic reconfiguration of multipathed disks. See the `vxdisk(1M)` manual page for more information.

Partial Device Discovery

The Dynamic Multipathing (DMP) feature of VxVM supports partial device discovery where you can include or exclude sets of disks or disks attached to controllers from the discovery process.

The `vxdisk scandisks` command re-scans the devices in the OS device tree and triggers a DMP reconfiguration. You can specify parameters to `vxdisk scandisks` to implement partial device discovery. For example, this command makes VxVM discover newly added devices that were unknown to it earlier:

```
# vxdisk scandisks new
```

The next example discovers fabric devices:

```
# vxdisk scandisks fabric
```

The following command scans for the devices `c1t1d0` and `c2t2d0`:

```
# vxdisk scandisks device=c1t1d0,c2t2d0
```

Alternatively, you can specify a `!` prefix character to indicate that you want to scan for all devices *except* those that are listed:

```
# vxdisk scandisks !device=c1t1d0,c2t2d0
```

You can also scan for devices that are connected (or not connected) to a list of logical or physical controllers. For example, this command discovers and configures all devices except those that are connected to the specified logical controllers:

```
# vxdisk scandisks !ctrl=c1,c2
```



The next command discovers devices that are connected to the specified physical controller:

```
# vxdisk scandisks pctlr=8/12.8.0.255.0
```

Note The items in a list of physical controllers are separated by + characters.

You can use the command `vxddmpadm getctlr all` to obtain a list of physical controllers.

You can specify only one selection argument to the `vxdisk scandisks` command. Specifying multiple options results in an error.

For more information, see the `vxdisk(1M)` manual page.

Discovering Disks and Dynamically Adding Disk Arrays

You can dynamically add support for a new type of disk array which has been developed by a third-party vendor. The support comes in the form of vendor-supplied libraries, and is added to an HP-UX system by using the `swinstall` command.

Disk Categories

Disk arrays that have been certified for use with VERITAS Volume Manager are supported by an array support library (ASL), and are categorized by the vendor ID string that is returned by the disks (for example, "HITACHI").

Disks in JBODs for which DMP (see "[Administering Dynamic Multipathing \(DMP\)](#)" on page 101) can be supported in Active/Active mode, and which are capable of being multipathed, are placed in the `DISKS` category. Disks in unsupported arrays can be placed in this category by following the steps given in "[Adding Unsupported Disk Arrays to the DISKS Category](#)" on page 68.

Disks in JBODs that do not fall into any supported category, and which are not capable of being multipathed by DMP are placed in the `OTHER_DISKS` category.

Adding Support for a New Disk Array

The following example illustrates how to add support for a new disk array named `vrtsda` to an HP-UX system using a vendor-supplied package on a mounted CD-ROM:

```
# swinstall -s /cdrom vrtsda
```

The new disk array does not need to be already connected to the system when the package is installed. If any of the disks in the new disk array are subsequently connected, and if `vxconfigd` is running, `vxconfigd` immediately invokes the Device Discovery function and includes the new disks in the VxVM device list.

Enabling Discovery of New Devices

To have VxVM discover a new disk array, use the following command:

```
# vxdtctl enable
```

This command scans all of the disk devices and their attributes, updates the VxVM device list, and reconfigures DMP with the new device database. There is no need to reboot the host.

Note This command ensures that dynamic multipathing is set up correctly on the array. Otherwise, VxVM treats the independent paths to the disks as separate devices, which can result in data corruption.

Removing Support for a Disk Array

To remove support for the `vrtsda` disk array, use the following command:

```
# swremove vrtsda
```

If the arrays remain physically connected to the host after support has been removed, they are listed in the `OTHER_DISKS` category, and the volumes remain available.

Third-Party Driver Coexistence

The third-party driver (TPD) coexistence feature of VxVM 4.1 allows I/O that is controlled by third-party multipathing drivers to bypass DMP while retaining the monitoring capabilities of DMP. Provided that a suitable ASL is available, devices that use TPDs can be discovered without requiring you to set up a specification file, or to run a special command. In previous releases, VxVM only supported TPD coexistence if the code of the third-party driver was intrusively modified. The new TPD coexistence feature maintains backward compatibility with such methods, but it also permits coexistence without require any change in a third-party multipathing driver.

See [“Changing Device Naming for TPD-Controlled Enclosures”](#) on page 72 for information on how to change the form of TPD device names that are displayed by VxVM.

See [“Displaying Information About TPD-Controlled Devices”](#) on page 115 for details of how to find out the TPD configuration information that is known to DMP.



Administering the Device Discovery Layer

Dynamic addition of disk arrays is possible because of the existence of the Device Discovery Layer (DDL) which is a facility for discovering disks and their attributes that are required for VxVM and DMP operations. The DDL is administered using the `vxddladm` utility, which can be used to perform the following tasks:

- ◆ List the types of arrays that are supported.
- ◆ Add support for an array to DDL.
- ◆ Remove support for an array from DDL.
- ◆ List information about excluded disk arrays.
- ◆ List disks that are supported in the `DISKS` (JBOD) category.
- ◆ Add disks from different vendors to the `DISKS` category.
- ◆ Remove disks from the `DISKS` category.
- ◆ Add disks as foreign devices.

The following sections explain these tasks in more detail. For further information, see the `vxddladm(1M)` manual page.

Listing Details of Supported Disk Arrays

To list all currently supported disk arrays, use the following command:

```
# vxddladm listsupport all
```

Note Use this command to obtain values for the `vid` and `pid` attributes that are used with other forms of the `vxddladm` command.

To display more detailed information about a particular array library, use this form of the command:

```
# vxddladm listsupport libname=library_name.sl
```

This command displays the vendor ID (VID), product IDs (PIDs) for the arrays, array types (for example, A/A or A/P), and array names. The following is sample output.

```
# vxddladm listsupport libname=libvxfujitsu.so
ATTR_NAME          ATTR_VALUE
=====
LIBNAME            libvxfujitsu.so
VID                vendor
PID                GR710, GR720, GR730
                   GR740, GR820, GR840
ARRAY_TYPE         A/A, A/P
```



```
ARRAY_NAME          FJ_GR710, FJ_GR720, FJ_GR730
                   FJ_GR740, FJ_GR820, FJ_GR840
```

Excluding Support for a Disk Array Library

To exclude all arrays that depend on a particular array library from participating in device discovery, use the following command:

```
# vxddladm excludearray libname=libvxenc.sl
```

This example excludes support for disk arrays that depends on the library `libvxenc.sl`. You can also exclude support for disk arrays from a particular vendor, as shown in this example:

```
# vxddladm excludearray vid=ACME pid=X1
```

For more information about excluding disk array support, see the `vxddladm (1M)` manual page.

Re-including Support for an Excluded Disk Array Library

If you have excluded support for all arrays that depend on a particular disk array library, you can use the `includearray` keyword to remove the entry from the exclude list, as shown in the following example:

```
# vxddladm includearray libname=libvxenc.sl
```

This command adds the array library to the database so that the library can once again be used in device discovery. If `vxconfigd` is running, you can use the `vxdisk scandisks` command to discover the arrays and add their details to the database.

Listing Excluded Disk Arrays

To list all disk arrays that are currently excluded from use by VxVM, use the following command:

```
# vxddladm listexclude
```

Listing Supported Disks in the DISKS Category

To list disks that are supported in the `DISKS (JBOD)` category, use the following command:

```
# vxddladm listjbod
```



Adding Unsupported Disk Arrays to the DISKS Category

Caution The procedure in this section ensures that Dynamic Multipathing (DMP) is set up correctly on an array that is not supported by VERITAS Volume Manager. Otherwise, VERITAS Volume Manager treats the independent paths to the disks as separate devices, which can result in data corruption.

To add an unsupported disk array:

1. Use the following command to identify the vendor ID and product ID of the disks in the array:

```
# /etc/vx/diag.d/vxdmpinq device_name
```

where *device_name* is the device name of one of the disks in the array (for example, `/dev/rdisk/c1t20d0`). Note the values of the vendor ID (VID) and product ID (PID) in the output from this command. For Fujitsu disks, also note the number of characters in the serial number that is displayed. The following is sample output:

```
# /etc/vx/diag.d/vxdmpinq /dev/rdisk/c1t20d0
Vendor id (VID) : SEAGATE
Product id (PID): ST318404LSUN18G
Revision      : 8507
Serial Number  : 0025T0LA3H
```

In this example, the vendor ID is SEAGATE and the product ID is ST318404LSUN18G.

2. Enter the following command to add a new JBOD category:

```
# vxddladm addjbod vid=vendorid pid=productid [length=serialno_length]
```

where *vendorid* and *productid* are the VID and PID values that you found from the previous step. For example, *vendorid* might be FUJITSU, IBM, or SEAGATE. For Fujitsu devices, you must also specify the number of characters in the serial number as the argument to the `length` argument (for example, 10).

Note In VxVM 4.0 and later releases, a SEAGATE disk is added as a JBOD device by default.

Continuing the previous example, the command to define an array of disks of this type as a JBOD would be:

```
# vxddladm addjbod vid=SEAGATE pid=ST318404LSUN18G
```

3. Use the `vxdctl enable` command to bring the array under VxVM control as described in “[Enabling Discovery of New Devices](#)” on page 65:

```
# vxdctl enable
```

4. To verify that the array is now supported, enter the following command:

```
# vxddladm listjbod
```

The following is sample output from this command for the example array:

```
VID          PID          Opcode  Page Code  Page Offset  SNO length
=====
SEAGATE     ALL PIDs  18      -1          36           12
```

5. To verify that the array is recognized, use the `vxddpadm listenclosure` command as shown in the following sample output for the example array:

```
# vxddpadm listenclosure all
ENCLR_NAME      ENCLR_TYPE      ENCLR_SNO      STATUS
=====
OTHER_DISKS     OTHER_DISKS     OTHER_DISKS     CONNECTED
Disk            Disk            DISKS           CONNECTED
```

The enclosure name and type for the array are both shown as being set to `Disk`. You can use the `vxdisk list` command to display the disks in the array:

```
# vxdisk list
DEVICE  TYPE          DISK  GROUP  STATUS
Disk_0  auto:none    -     -      online invalid
Disk_1  auto:none    -     -      online invalid
...
```

6. To verify that the DMP paths are recognized, use the `vxddpadm getdmpnode` command as shown in the following sample output for the example array:

```
# vxddpadm getdmpnode enclosure=Disk
NAME      STATE      ENCLR-TYPE  PATHS  ENBL  DSBL  ENCLR-NAME
=====
Disk_0    ENABLED    Disk        2      2     0     Disk
Disk_1    ENABLED    Disk        2      2     0     Disk
...
```

This shows that there are two paths to the disks in the array.

For more information, enter the command `vxddladm help addjbod`, or see the `vxddladm(1M)` and `vxddpadm(1M)` manual pages.

Removing Disks from the DISKS Category

To remove disks from the `DISKS` (JBOD) category, use the `vxddladm` command with the `rmjbod` keyword. The following example illustrates the command for removing disks supplied by the vendor, Seagate:

```
# vxddladm rmjbod vid=SEAGATE
```



Adding Foreign Devices

DDL may not be able to discover some devices that are controlled by third-party drivers, such as those that provide multipathing or RAM disk capabilities. For these devices it may be preferable to use the multipathing capability that is provided by the third-party drivers for some arrays rather than using the Dynamic Multipathing (DMP) feature. Such *foreign devices* can be made available as simple disks to VxVM by using the `vxddladm addforeign` command. This also has the effect of bypassing DMP for handling I/O. The following example shows how to add entries for block and character devices in the specified directories:

```
# vxddladm addforeign blockdir=/dev/foo/dsk chardir=/dev/foo/rdisk
```

By default, this command suppresses any entries for matching devices in the OS-maintained device tree that are found by the autodiscovery mechanism. You can override this behavior by using the `-f` and `-n` options as described on the `vxddladm(1M)` manual page.

After adding entries for the foreign devices, use either the `vxdisk scandisks` or the `vxctl enable` command to discover the devices as simple disks. These disks then behave in the same way as autoconfigured disks.

The foreign device mechanism was introduced in VxVM 4.0 to support non-standard devices such as RAM disks, some solid state disks, and pseudo-devices such as EMC PowerPath. This mechanism has a number of limitations:

- ◆ A foreign device is always considered as simple disk with a single path. Unlike an autodiscovered disk, it does not have a DMP node.
- ◆ It is not supported for shared disk groups in a clustered environment. Only standalone host systems are supported.
- ◆ It is not supported for Persistent Group Reservation (PGR) operations.
- ◆ It is not under the control of DMP, so enabling of a failed disk cannot be automatic, and DMP administrative commands are not applicable.
- ◆ Enclosure information is not available to VxVM. This can reduce the availability of any disk groups that are created using such devices.

If a suitable ASL is available for an array, these limitations are removed, as described in “[Third-Party Driver Coexistence](#)” on page 65.

Placing Disks Under VxVM Control

When you add a disk to a system that is running VxVM, you need to put the disk under VxVM control so that VxVM can control the space allocation on the disk. Unless you specify a disk group, VxVM places new disks in a default disk group according to the rules given in [“Rules for Determining the Default Disk Group”](#) on page 133.

The method by which you place a disk under VxVM control depends on the circumstances:

- ◆ If the disk is new, it must be *initialized* and placed under VxVM control. You can use the menu-based `vxdiskadm` utility to do this.

Caution Initialization destroys existing data on disks.

- ◆ If the disk is not needed immediately, it can be initialized (but not added to a disk group) and reserved for future use. To do this, enter **none** when asked to name a disk group. Do not confuse this type of “spare disk” with a hot-relocation spare disk.
- ◆ If the disk was previously initialized for future use by VxVM, it can be reinitialized and placed under VxVM control.
- ◆ If the disk was previously used for a file system, VxVM prompts you to confirm that you really want to destroy the file system.
- ◆ If the disk was previously in use by the LVM subsystem, you can preserve existing data while still letting VxVM take control of the disk. This is accomplished using *conversion*. With conversion, the virtual layout of the data is fully converted to VxVM control (see the *VERITAS Volume Manager Migration Guide*).
- ◆ If the disk was previously in use by the LVM subsystem, but you do not want to preserve the data on it, use the LVM command, `pvremove`, before attempting to initialize the disk for VxVM.
- ◆ Multiple disks on one or more controllers can be placed under VxVM control simultaneously. Depending on the circumstances, all of the disks may not be processed the same way.

It is possible to configure the `vxdiskadm` utility not to list certain disks or controllers as being available. For example, this may be useful in a SAN environment where disk enclosures are visible to a number of separate systems.

To exclude a device from the view of VxVM, select item 16 (Prevent multipathing/Suppress devices from VxVM’s view) from the `vxdiskadm` main menu. See [“Disabling and Enabling Multipathing for Specific Devices”](#) on page 106 for details.



Changing the Disk-Naming Scheme

Note Devices with very long device names (for example, Fibre Channel devices that include worldwide name (WWN) identifiers) are always represented by enclosure-based names. The operation in this section has no effect on such devices.

You can either use enclosure-based naming for disks or the operating system's naming scheme (such as `c#t#d#`). Select menu item 20 from the `vxdiskadm` main menu to change the disk-naming scheme that you want VxVM to use. When prompted, enter **y** to change the naming scheme. This restarts the `vxconfig` daemon to bring the new disk naming scheme into effect.

Alternatively, you can change the naming scheme from the command line. The following commands select enclosure-based and operating system-based naming respectively:

```
# vxddladm set namingscheme=ebn
# vxddladm set namingscheme=osn
```

The change is immediate whichever method you use.

Changing Device Naming for TPD-Controlled Enclosures

Note This feature is available only if the default disk-naming scheme is set to use operating system-based naming, and the TPD-controlled enclosure does not contain fabric disks.

For disk enclosures that are controlled by third-party drivers (TPD) whose coexistence is supported by an appropriate ASL, the default behavior is to assign device names that are based on the TPD-assigned node names. You can use the `vxdlmpadm` command to switch between these names and the device names that are known to the operating system:

```
# vxdlmpadm setattr enclosure enclosure tpdmode=native|pseudo
```

The argument to the `tpdmode` attribute selects names that are based on those used by the operating system (`native`), or TPD-assigned node names (`pseudo`).

The use of this command to change between TPD and operating system-based naming is illustrated in the following example for the enclosure named EMC0:

```
# vxdisk list
DEVICE          TYPE          DISK          GROUP         STATUS
emcpower10     auto:hpdisk   disk1         mydg          online
emcpower11     auto:hpdisk   disk2         mydg          online
emcpower12     auto:hpdisk   disk3         mydg          online
emcpower13     auto:hpdisk   disk4         mydg          online
emcpower14     auto:hpdisk   disk5         mydg          online
emcpower15     auto:hpdisk   disk6         mydg          online
emcpower16     auto:hpdisk   disk7         mydg          online
emcpower17     auto:hpdisk   disk8         mydg          online
emcpower18     auto:hpdisk   disk9         mydg          online
emcpower19     auto:hpdisk   disk10        mydg          online

# vxddm padm setattr enclosure EMC0 tpdmode=native

# vxdisk list
DEVICE          TYPE          DISK          GROUP         STATUS
c6t0d10        auto:hpdisk   disk1         mydg          online
c6t0d11        auto:hpdisk   disk2         mydg          online
c6t0d12        auto:hpdisk   disk3         mydg          online
c6t0d13        auto:hpdisk   disk4         mydg          online
c6t0d14        auto:hpdisk   disk5         mydg          online
c6t0d15        auto:hpdisk   disk6         mydg          online
c6t0d16        auto:hpdisk   disk7         mydg          online
c6t0d17        auto:hpdisk   disk8         mydg          online
c6t0d18        auto:hpdisk   disk9         mydg          online
c6t0d19        auto:hpdisk   disk10        mydg          online
```

If `tpdmode` is set to `native`, the path with the smallest device number is displayed.

Discovering the Association between Enclosure-Based Disk Names and OS-Based Disk Names

If you enable enclosure-based naming, and use the `vxprint` command to display the structure of a volume, it shows enclosure-based disk device names (disk access names) rather than `c#t#d#` names. To discover the `c#t#d#` names that are associated with a given enclosure-based disk name, use either of the following commands:

```
# vxdisk list enclosure-based_name
# vxddm padm getsubpaths dmpnodename=enclosure-based_name
```



For example, to find the physical device that is associated with disk `ENC0_21`, the appropriate commands would be:

```
# vxdisk list ENC0_21
# vxdmpadm getsubpaths dmpnodename=ENC0_21
```

To obtain the full pathname for the block and character disk device from these commands, append the displayed device name to `/dev/vx/dmp` or `/dev/vx/rdmp`.

Regenerating the Persistent Device Name Database

The persistent device naming feature, introduced in VxVM 4.1, makes the names of disk devices persistent across system reboots. If operating system-based naming is selected, each disk name is usually set to the name of one of the paths to the disk. After hardware reconfiguration and a subsequent reboot, the operating system may generate different names for the paths to the disks. As DDL assigns persistent disk names using the persistent device name database that was generated during a previous boot session, the disk names may no longer correspond to the actual paths. This does not prevent the disks from being used, but the association between the disk name and one of its paths is lost.

To find the relationship between a disk and its paths, run one of the following commands:

```
# vxdmpadm getsubpaths dmpnodename=disk_access_name
# vxdisk list disk_access_name
```

If you want to update the disk names so that they correspond to the new path names, perform the following steps:

1. Remove the file that contains the existing persistent device name database:

```
# rm /etc/vx/disk.info
```

2. Restart the VxVM configuration demon:

```
# vxconfigd -k
```

This regenerates the persistent name database.

Issues Regarding Persistent Simple/Nopriv Disks with Enclosure-Based Naming

If you change from `c##d##` based naming to enclosure-based naming, persistent simple or nopriv disks may be put in the “error” state and cause VxVM objects on those disks to fail. If this happens, use the following procedures to correct the problem:

- ◆ [Persistent Simple/Nopriv Disks in the Boot Disk Group](#)
- ◆ [Persistent Simple/Nopriv Disks in Non-Boot Disk Groups](#)

These procedures use the `vxdarestore` utility to handle errors in persistent simple and nopriv disks that arise from changing to the enclosure-based naming scheme. You do not need to perform either procedure if the devices on which any simple or nopriv disks are present are not automatically configured by VxVM (for example, non-standard disk devices such as ramdisks).

Note The disk access records for simple disks are either persistent or non-persistent. The disk access record for a persistent simple disk is stored in the disk’s private region. The disk access record for a non-persistent simple disk is automatically configured in memory at VxVM startup. A simple disk has a non-persistent disk access record if `autoconfig` is included in the `flags` field that is displayed by the `vxdisk list disk_access_name` command. If the `autoconfig` flag is not present, the disk access record is persistent. Nopriv disks are always persistent.

Note You cannot run `vxdarestore` if `c##d##` naming is in use. Additionally, `vxdarestore` does not handle failures on persistent simple/nopriv disks that are caused by renaming enclosures, by hardware reconfiguration that changes device names, or by removing support from the JBOD category for disks that belong to a particular vendor when enclosure-based naming is in use.

For more information about the `vxdarestore` command, see the `vxdarestore(1M)` manual page.

Persistent Simple/Nopriv Disks in the Boot Disk Group

If *all* persistent simple and nopriv disks in the boot disk group (usually aliased as `bootdg`) go into the error state and the `vxconfigd` daemon is disabled after the naming scheme change, perform the following steps:

1. Use `vxdiskadm` to change back to `c##d##` naming.
2. Enter the following command to restart the VxVM configuration daemon:

```
# vxconfigd -kr reset
```



3. If you want to use enclosure-based naming, use `vxdiskadm` to add a non-persistent simple disk to the `bootdg` disk group, change back to the enclosure-based naming scheme, and then run the following command:

```
# /etc/vx/bin/vxdarestore
```

Note If not all the disks in `bootdg` go into the error state, you need only run `vxdarestore` to restore the disks that are in the error state and the objects that they contain.

Persistent Simple/Nopriv Disks in Non-Boot Disk Groups

If an imported disk group other than `bootdg`, consisting *only* of persistent simple and/or nopriv disks, is put in the “online `dgdisabled`” state after the change to the enclosure-based naming scheme, perform the following steps:

1. Deport the disk group using the following command:

```
# vxvg deport diskgroup
```

2. Use the `vxdarestore` command to restore the failed disks, and to recover the objects on those disks:

```
# /etc/vx/bin/vxdarestore
```

3. Re-import the disk group using the following command:

```
# vxvg import diskgroup
```

Installing and Formatting Disks

Depending on the hardware capabilities of your disks and of your system, you may either need to shut down and power off your system before installing the disks, or you may be able to hot-insert the disks into the live system. Many operating systems can detect the presence of the new disks on being rebooted. If the disks are inserted while the system is live, you may need to enter an operating system-specific command to notify the system.

If the disks require low or intermediate-level formatting before use, use the operating system-specific formatting command to do this.

Note SCSI disks are usually preformatted. Reformatting is needed only if the existing formatting has become damaged.

The following sections provide detailed examples of how to use the `vxdiskadm` utility to place disks under VxVM control in various ways and circumstances.



Displaying and Changing Default Disk Layout Attributes

To display or change the default values for initializing disks, select menu item 21 (Change/display the default disk layout) from the `vxdiskadm` main menu. For disk initialization, you can change the default format and the default length of the private region.

The attribute settings for initializing disks are stored in the file, `/etc/default/vxdisk`. See the `vxdisk(1M)` manual page for more information.

Adding a Disk to VxVM

Formatted disks being placed under VxVM control may be new or previously used outside VxVM. The set of disks can consist of all disks on the system, all disks on a controller, selected disks, or a combination of these.

Depending on the circumstances, all of the disks may not be processed in the same way.

Caution Initialization does not preserve data on disks.

When initializing multiple disks at one time, it is possible to exclude certain disks or certain controllers. To exclude disks, list the names of the disks to be excluded in the file `/etc/vx/disks.exclude` before the initialization. You can exclude all disks on specific controllers from initialization by listing those controllers in the file `/etc/vx/cntrls.exclude`.

Initialize disks for VxVM use as follows:

1. Select menu item 1 (Add or initialize one or more disks) from the `vxdiskadm` main menu.
2. At the following prompt, enter the disk device name of the disk to be added to VxVM control (or enter **list** for a list of disks):

```
Add or initialize disks
Menu: VolumeManager/Disk/AddDisks
```

Use this operation to add one or more disks to a disk group. You can add the selected disks to an existing disk group or to a new disk group that will be created as a part of the operation. The selected disks may also be added to a disk group as spares. Or they may be added as `nohotuses` to be excluded from hot-relocation use. The selected disks may also be initialized without adding them to a disk group leaving the disks available for use as replacement disks.



More than one disk or pattern may be entered at the prompt. Here are some disk selection examples:

```
all:          all disks
c3 c4t2:     all disks on both controller 3 and controller
             4,target 2
c3t4d2:     a single disk (in the c#t#d# naming scheme)
xyz_0 :     a single disk (in the enclosure based naming scheme)
xyz_ :      all disks on the enclosure whose name is xyz
```

Select disk devices to add:
[<pattern-list>,all,list,q,?]

<pattern-list> can be a single disk, or a series of disks and/or controllers (with optional targets). If <pattern-list> consists of multiple items, separate them using white space, for example:

c3t0d0 c3t1d0 c3t2d0 c3t3d0

specifies four disks at separate target IDs on controller 3.

If you enter **list** at the prompt, the `vxdiskadm` program displays a list of the disks available to the system:

DEVICE	DISK	GROUP	STATUS
c2t4d0	-	-	LVM
c2t5d0	-	-	LVM
c2t6d0	-	-	LVM
c3t0d0	mydg01	mydg	online
c3t1d0	mydg03	mydg	online
c3t2d0	mydg04	mydg	online
c3t3d0	mydg05	mydg	online
c3t8d0	mydg06	mydg	online
c3t9d0	mydg07	mydg	online
c3t10d0	mydg02	mydg	online
c4t1d0	mydg08	mydg	online
c4t2d0	TCd1-18238	TCg1-18238	online
c4t13d0	-	-	online invalid
c4t14d0	-	-	online
.			
.			
.			

Select disk devices to add:
[<pattern-list>,all,list,q,?]

The phrase `online invalid` in the `STATUS` line indicates that a disk has yet to be added or initialized for VxVM control. Disks that are listed as `online` with a disk name and disk group are already under VxVM control.

Enter the device name or pattern of the disks that you want to initialize at the prompt and press Return.

3. To continue with the operation, enter **y** (or press Return) at the following prompt:

Here are the disks selected. Output format: [Device]

list of device names

Continue operation? [y,n,q,?] (default: y) **y**

4. At the following prompt, specify the disk group to which the disk should be added, or **none** to reserve the disks for future use:

You can choose to add these disks to an existing disk group, a new disk group, or you can leave these disks available for use by future add or replacement operations. To create a new disk group, select a disk group name that does not yet exist. To leave the disks available for future use, specify a disk group name of "none".

Which disk group [<group>,none,list,q,?]

5. If you specified the name of a disk group that does not already exist, vxdiskadm prompts for confirmation that you really want to create this new disk group:

There is no active disk group named *disk group name*.

Create a new group named *disk group name*? [y,n,q,?] (default: y) **y**

You are then prompted to confirm whether the disk group should support the Cross-platform Data Sharing (CDS) feature:

Create the disk group as a CDS disk group? [y,n,q,?] (default: n)

If the new disk group may be moved between different operating system platforms, enter **y**. Otherwise, enter **n**.

6. At the following prompt, either press Return to accept the default disk name or enter **n** to allow you to define your own disk names:

Use default disk names for the disks? [y,n,q,?] (default: y)

7. When prompted whether the disks should become hot-relocation spares, enter **n** (or press Return):

Add disks as spare disks for *disk group name*? [y,n,q,?] (default: n) **n**



8. When prompted whether to exclude the disks from hot-relocation use, enter **n** (or press Return).

```
Exclude disk from hot-relocation use? [y,n,q,?] (default: n) n
```

9. To continue with the operation, enter **y** (or press Return) at the following prompt:

```
The selected disks will be added to the disk group disk group name
with default disk names.
```

```
list of device names
```

```
Continue with operation? [y,n,q,?] (default: y) y
```

10. If one or more disks already contains a file system, vxdiskadm asks if you are sure that want to destroy it. Enter **y** to confirm this:

```
The following disk device appears to contain a currently unmounted
file system.
```

```
list of device names
```

```
Are you sure you want to destroy these file systems
[y,n,q,?] (default: n) y
```

vxdiskadm asks you to confirm that the devices are to be reinitialized before proceeding:

```
Reinitialize these devices? [y,n,q,?] (default: n) y
VxVM INFO V-5-2-205 Initializing device device name.
```

11. You can now choose whether the disk is to be formatted as a CDS disk that is portable between different operating systems, or as a non-portable hpdisk-format disk:

```
Enter the desired format [cdsdisk,hpdisk,q,?] (default: cdsdisk)
```

Enter the format that is appropriate for your needs. In most cases, this is the default format, cdsdisk.

12. At the following prompt, vxdiskadm asks if you want to use the default private region size of 2048 blocks. Press Return to confirm that you want to use the default value, or enter a different value. (The maximum value that you can specify is 524288 blocks.)

```
Enter desired private region length [<privlen>,q,?] (default: 2048)
```

vxdiskadm then proceeds to add the disks.

```
Adding disk device device name to disk group disk group name with
disk name disk name.
```

```
.
.
.
```

Note To bring LVM disks under VxVM control, use the Migration Utilities. See the *VERITAS Volume Manager Migration Guide* for details.

13. At the following prompt, indicate whether you want to continue to initialize more disks (**y**) or return to the `vxdiskadm` main menu (**n**):

```
Add or initialize other disks? [y,n,q,?] (default: n)
```

See “[Displaying and Changing Default Disk Layout Attributes](#)” on page 77 for details of how to change the default layout that is used to initialize disks.

Reinitializing a Disk

You can reinitialize a disk that has previously been initialized for use by VxVM by putting it under VxVM control as you would a new disk. See “[Adding a Disk to VxVM](#)” on page 77 for details.

Caution Reinitialization does not preserve data on the disk. If you want to reinitialize the disk, make sure that it does not contain data that should be preserved.

If the disk you want to add has previously been under LVM control, you can preserve the data it contains on a VxVM disk by the process of conversion (see the *VERITAS Volume Manager Migration Guide* for more details).

Using `vxdiskadd` to Place a Disk Under Control of VxVM

As an alternative to `vxdiskadm`, you can use the `vxdiskadd` command to put a disk under VxVM control. For example, to initialize the second disk on the first controller, use the following command:

```
# vxdiskadd c0t1d0
```

The `vxdiskadd` command examines your disk to determine whether it has been initialized and also checks for disks that have been added to VxVM, and for other conditions.

Note If you are adding an uninitialized disk, warning and error messages are displayed on the console during the `vxdiskadd` command. Ignore these messages. These messages should not appear after the disk has been fully initialized; the `vxdiskadd` command displays a success message when the initialization completes.

The interactive dialog for adding a disk using `vxdiskadd` is similar to that for `vxdiskadm`, described in “[Adding a Disk to VxVM](#)” on page 77.



Rootability

Rootability indicates that the volumes containing the `root` file system and the system swap area are under VxVM control. Without rootability, VxVM is usually started *after* the operating system kernel has passed control to the initial user mode process at boot time. However, if the volume containing the `root` file system is under VxVM control, the kernel starts portions of VxVM *before* starting the first user mode process.

Under HP-UX, a bootable root disk contains a Logical Interchange Format (LIF) area. The LIF LABEL record in the LIF area contains information about the starting block number, and the length of the volumes that contain the `stand` and `root` file systems and the system swap area. When a VxVM root disk is made bootable, the LIF LABEL record is initialized with volume extent information for the `stand`, `root`, `swap`, and `dump` (if present) volumes.

See [“Setting up a VxVM Root Disk and Mirror”](#) on page 84 for details of how to configure a bootable VxVM root disk from an existing LVM root disk.

Note From the AR0902 release of HP-UX 11i onward, you can choose to configure either a VxVM root disk or an LVM root disk at install time. See the *HP-UX Installation and Configuration Guide* for more information.

See the chapter “Recovery from Boot Disk Failure” in the *VERITAS Volume Manager Troubleshooting Guide*, for information on how to replace a failed boot disk.

VxVM Root Disk Volume Restrictions

Volumes on a bootable VxVM root disk have the following configuration restrictions:

- ◆ All volumes on the root disk must be in the disk group that you choose to be the `bootdg` disk group.
- ◆ The names of the volumes with entries in the LIF LABEL record must be `standvol`, `rootvol`, `swapvol`, and `dumpvol` (if present). The names of the volumes for other file systems on the root disk are generated by appending `vol` to the name of their mount point under `/`.
- ◆ Any volume with an entry in the LIF LABEL record must be contiguous. It can have only one subdisk, and it cannot span to another disk.
- ◆ The `rootvol` and `swapvol` volumes must have the special volume usage types `root` and `swap` respectively.
- ◆ Only the disk access types `auto` with format `hpdisk`, and `simple` are suitable for use as VxVM root disks, root disk mirrors, or as hot-relocation spares for such disks. An auto-configured `cdsdisk` format disk, which supports the Cross-platform Data

Sharing (CDS) feature, cannot be used. The `vxcp_lvmroot` and `vxrootmir` commands automatically configure a suitable disk type on the physical disks that you specify are to be used as VxVM root disks and mirrors.

- ◆ The volumes on the root disk cannot use dirty region logging (DRL).

Root Disk Mirrors

All the volumes on a VxVM root disk may be mirrored. The simplest way to achieve this is to mirror the VxVM root disk onto an identically sized or larger physical disk. If a mirror of the root disk must also be bootable, the restrictions listed in “[Booting Root Volumes](#)” on page 83 also apply to the mirror disk.

Note If you mirror only selected volumes on the root disk and use spanning or striping to enhance performance, these mirrors are not bootable.

See “[Setting up a VxVM Root Disk and Mirror](#)” on page 84 for details of how to create a mirror of a VxVM root disk.

Booting Root Volumes

Note At boot time, the system firmware provides you with a short time period during which you can manually override the automatic boot process and select an alternate boot device. For information on how to boot your system from a device other than the primary or alternate boot devices, and how to change the primary and alternate boot devices, see the HP-UX documentation and the `boot(1M)`, `pdc(1M)` and `isl(1M)` manual pages.

Before the kernel mounts the `root` file system, it determines if the boot disk is a rootable VxVM disk. If it is such a disk, the kernel passes control to its VxVM rootability code. This code extracts the starting block number and length of the `root` and `swap` volumes from the LIF LABEL record, builds temporary volume and disk configuration objects for these volumes, and then loads this configuration into the VxVM kernel driver. At this point, I/O can take place for these temporary `root` and `swap` volumes by referencing the device number set up by the rootability code.

When the kernel has passed control to the initial user procedure, the VxVM configuration daemon (`vxconfigd`) is started. `vxconfigd` reads the configuration of the volumes in the `bootdg` disk group and loads them into the kernel. The temporary `root` and `swap` volumes are then discarded. Further I/O for these volumes is performed using the VxVM configuration objects that were loaded into the kernel.



Setting up a VxVM Root Disk and Mirror

Note These procedures should be carried out at `init` level 1.

To set up a VxVM root disk and a bootable mirror of this disk, use the `vxcp_lvmroot` utility. This command initializes a specified physical disk as a VxVM root disk named `rootdisk##` (where `##` is the first number starting at 01 that creates a unique disk name), copies the contents of the volumes on the LVM root disk to the new VxVM root disk, optionally creates a mirror of the VxVM root disk on another specified physical disk, and make the VxVM root disk and its mirror (if any) bootable by HP-UX.

The following example shows how to set up a VxVM root disk on the physical disk `c0t4d0`:

```
# /etc/vx/bin/vxcp_lvmroot -b c0t4d0
```

Note The `-b` option to `vxcp_lvmroot` uses the `setboot` command to define `c0t4d0` as the *primary* boot device. If this option is not specified, the primary boot device is not changed.

If the destination VxVM root disk is not big enough to accommodate the contents of the LVM root disk, you can use the `-R` option to specify a percentage by which to reduce the size of the file systems on the target disk. (This takes advantage of the fact that most of these file systems are usually nowhere near 100% full.) For example, to specify a size reduction of 30%, the following command would be used:

```
# /etc/vx/bin/vxcp_lvmroot -R 30 -v -b c0t4d0
```

The verbose option, `-v`, is specified to give an indication of the progress of the operation.

Caution Only create a VxVM root disk if you also intend to mirror it. There is no benefit in having a non-mirrored VxVM root disk for its own sake.

The next example uses the same command and additionally specifies the `-m` option to set up a root mirror on disk `c1t1d0`:

```
# /etc/vx/bin/vxcp_lvmroot -m c1t1d0 -R 30 -v -b c0t4d0
```

In this example, the `-b` option to `vxcp_lvmroot` sets `c0t4d0` as the primary boot device and `c1t1d0` as the *alternate* boot device.

This command is equivalent to using `vxcp_lvmroot` to create the VxVM-rootable disk, and then using the `vxrootmir` command to create the mirror:

```
# /etc/vx/bin/vxcp_lvmroot -R 30 -v -b c0t4d0
# /etc/vx/bin/vxrootmir -v -b c1t1d0
```

The disk name assigned to the VxVM root disk mirror also uses the format `rootdisk##` with `##` set to the next available number.

Note The target disk for a mirror that is added using the `vxrootmir` command must be large enough to accommodate the volumes from the VxVM root disk.

Once you have successfully rebooted the system from a VxVM root disk to `init` level 1, you can use the `vxdestroy_lvmroot` command to completely remove the original LVM root disk (and its associated LVM volume group), and re-use this disk as a mirror of the VxVM root disk, as shown in this example:

```
# /etc/vx/bin/vxdestroy_lvmroot -v c0t0d0
# /etc/vx/bin/vxrootmir -v -b c0t0d0
```

Note You may want to keep the LVM root disk in case you ever need a boot disk that does not depend on VxVM being present on the system. However, this may require that you update the contents of the LVM root disk in parallel with changes that you make to the VxVM root disk. See [“Creating an LVM Root Disk from a VxVM Root Disk”](#) on page 85 for a description of how to create a bootable LVM root disk from the VxVM root disk.

For more information, see the `vxcp_lvmroot(1M)`, `vxrootmir(1M)`, `vxdestroy_lvmroot(1M)` and `vxres_lvmroot(1M)` manual pages.

Creating an LVM Root Disk from a VxVM Root Disk

Note These procedures should be carried out at `init` level 1.

In some circumstances, it may be necessary to boot the system from an LVM root disk. If an LVM root disk is no longer available or an existing LVM root disk is out-of-date, you can use the `vxres_lvmroot` command to create an LVM root disk on a spare physical disk that is not currently under LVM or VxVM control. The contents of the volumes on the existing VxVM root disk are copied to the new LVM root disk, and the LVM disk is then made bootable. This operation does not remove the VxVM root disk or any mirrors of this disk, nor does it affect their bootability.

Note The target disk must be large enough to accommodate the volumes from the VxVM root disk.

This example shows how to create an LVM root disk on physical disk `c0t1d0` after removing the existing LVM root disk configuration from that disk.

```
# /etc/vx/bin/vxdestroy_lvmroot -v c0t1d0
# /etc/vx/bin/vxres_lvmroot -v -b c0t1d0
```

The `-b` option to `vxres_lvmroot` sets `c0t1d0` as the primary boot device.



As these operations can take some time, the verbose option, `-v`, is specified to indicate how far the operation has progressed.

For more information, see the `vxres_lvmroot (1M)` manual page.

Adding Swap Disks to a VxVM Rootable System

On occasion, you may need to increase the amount of swap space for an HP-UX system. If your system has a VxVM root disk, use the procedure described below.

1. Create a new volume that is to be used for the swap area. The following example shows how to set up a non-mirrored 1GB simple volume:

```
# vxassist -g bootdg make swapvol2 1g
```

2. Add the new volume as a swap device to the `/etc/fstab` file as shown in this sample entry:

```
/dev/vx/dsk/bootdg/swapvol2 / swap pri=1 0 0
```

3. Use the System Administration Manager (SAM) to increase the value of the `maxswapchunks` tunable as required by the `swapon` command. For example, if you double the amount of swap space, double the value of `maxswapchunks`.

4. Build a new kernel and reboot the system:

```
# mk_kernel -v -o /stand/vmunix
# kmupdate
# reboot -r
```

Removing Disks

Note You must disable a disk group as described in “Disabling a Disk Group” on page 168 before you can remove the last disk in that group. Alternatively, you can destroy the disk group as described in “Destroying a Disk Group” on page 168.

You can remove a disk from a system and move it to another system if the disk is failing or has failed. Before removing the disk from the current system, you must:

1. Stop all activity by applications to volumes that are configured on the disk that is to be removed. Unmount file systems and shut down databases that are configured on the volumes.
2. Use the following command to stop the volumes:

```
# vxvol [-g diskgroup] stop volume1 volume2 ...
```
3. Move the volumes to other disks or back up the volumes. To move a volume, use `vxdiskadm` to mirror the volume on one or more disks, then remove the original copy of the volume. If the volumes are no longer needed, they can be removed instead of moved.

Before removing a disk, make sure any data on that disk has either been moved to other disks or is no longer needed. Then remove the disk from its disk group using the `vxdiskadm` utility, as follows:

1. Select menu item 2 (Remove a disk) from the `vxdiskadm` main menu.
2. At the following prompt, enter the disk name of the disk to be removed:

```
Remove a disk
Menu: VolumeManager/Disk/RemoveDisk
```

```
Use this operation to remove a disk from a disk group. This
operation takes a disk name as input. This is the same name that
you gave to the disk when you added the disk to the disk group.
```

```
Enter disk name [<disk>,list,q,?] mydg01
```

3. If there are any volumes on the disk, VxVM asks you whether they should be evacuated from the disk. If you wish to keep the volumes, answer **y**. Otherwise, answer **n**.



4. At the following verification prompt, press Return to continue:

```
VxVM NOTICE V-5-2-284 Requested operation is to remove disk mydg01
from group mydg.
```

```
Continue with operation? [y,n,q,?] (default: y)
```

The `vxdiskadm` utility removes the disk from the disk group and displays the following success message:

```
VxVM INFO V-5-2-268 Removal of disk mydg01 is complete.
```

You can now remove the disk or leave it on your system as a replacement.

5. At the following prompt, indicate whether you want to remove other disks (**y**) or return to the `vxdiskadm` main menu (**n**):

```
Remove another disk? [y,n,q,?] (default: n)
```

Removing a Disk with Subdisks

You can remove a disk on which some subdisks are defined. For example, you can consolidate all the volumes onto one disk. If you use the `vxdiskadm` program to remove a disk, you can choose to move volumes off that disk. To do this, run the `vxdiskadm` program and select item 2 (Remove a disk) from the main menu.

If the disk is used by some subdisks, the following message is displayed:

```
VxVM ERROR V-5-2-369 The following volumes currently use part of disk
mydg02:
```

```
home usrvol
```

```
Volumes must be moved from mydg02 before it can be removed.
```

```
Move volumes to other disks? [y,n,q,?] (default: n)
```

If you choose **y**, then all subdisks are moved off the disk, if possible. Some subdisks are not movable. A subdisk may not be movable for one of the following reasons:

- ◆ There is not enough space on the remaining disks in the subdisk's disk group.
- ◆ Plexes or striped subdisks cannot be allocated on different disks from existing plexes or striped subdisks in the volume.

If the `vxdiskadm` program cannot move some subdisks, remove some plexes from some disks to free more space before proceeding with the disk removal operation. See [“Removing a Volume”](#) on page 250 and [“Taking Plexes Offline”](#) on page 190 for information on how to remove volumes and plexes.

Removing a Disk with No Subdisks

To remove a disk that contains no subdisks from its disk group, run the `vxdiskadm` program and select item 2 (Remove a disk) from the main menu, and respond to the prompts as shown in this example to remove `mydg02`:

```
Enter disk name [<disk>,list,q,?] mydg02
```

```
VxVM NOTICE V-5-2-284 Requested operation is to remove disk mydg02
from group mydg.
```

```
Continue with operation? [y,n,q,?] (default: y) y
```

```
VxVM INFO V-5-2-268 Removal of disk mydg02 is complete.
```

```
Clobber disk headers? [y,n,q,?] (default: n) y
```

Enter **y** to remove the disk completely from VxVM control. If you do not want to remove the disk completely from VxVM control, enter **n**.

Removing a Disk from VxVM Control

After removing a disk from a disk group, you can permanently remove it from VERITAS Volume Manager control by running the `vxdiskunsetup` command:

```
# /usr/lib/vxvm/bin/vxdiskunsetup c#t#d#
```

Caution The `vxdiskunsetup` command removes a disk from VERITAS Volume Manager control by erasing the VxVM metadata on the disk. To prevent data loss, any data on the disk should first be evacuated from the disk. The `vxdiskunsetup` command should only be used by a system administrator who is trained and knowledgeable about VERITAS Volume Manager.



Removing and Replacing Disks

Note A replacement disk should have the same disk geometry as the disk that failed. That is, the replacement disk should have the same bytes per sector, sectors per track, tracks per cylinder and sectors per cylinder, same number of cylinders, and the same number of accessible cylinders.

If failures are starting to occur on a disk, but the disk has not yet failed completely, you can replace the disk. This involves detaching the failed or failing disk from its disk group, followed by replacing the failed or failing disk with a new one. Replacing the disk can be postponed until a later date if necessary.

To replace a disk, use the following procedure:

1. Select menu item 3 (Remove a disk for replacement) from the `vxdiskadm` main menu.
2. At the following prompt, enter the name of the disk to be replaced (or enter **list** for a list of disks):

```
Remove a disk for replacement
Menu: VolumeManager/Disk/RemoveForReplace
```

```
Use this menu operation to remove a physical disk from a disk
group, while retaining the disk name. This changes the state for
the disk name to a removed disk. If there are any initialized disks
that are not part of a disk group, you will be
given the option of using one of these disks as a replacement.
```

```
Enter disk name [<disk>,list,q,?] mydg02
```

3. When you select a disk to remove for replacement, all volumes that are affected by the operation are displayed, for example:

```
VxVM NOTICE V-5-2-371 The following volumes will lose mirrors as a
result of this operation:
```

```
home src
```

```
No data on these volumes will be lost.
```

```
The following volumes are in use, and will be disabled as a result
of this operation:
```

```
mkting
```

```
Any applications using these volumes will fail future accesses.
These volumes will require restoration from backup.
```

```
Are you sure you want do this? [y,n,q,?] (default: n)
```

To remove the disk, causing the named volumes to be disabled and data to be lost when the disk is replaced, enter **y** or press Return.

To abandon removal of the disk, and back up or move the data associated with the volumes that would otherwise be disabled, enter **n** or **q** and press Return.

For example, to move the volume `mkting` to a disk other than `mydg02`, use this command:

```
# vxassist move mkting !mydg02
```

After backing up or moving the data in the volumes, start again from step 1 above.

4. At the following prompt, either select the device name of the replacement disk (from the list provided), press Return to choose the default disk, or enter **none** if you are going to replace the physical disk:

```
The following devices are available as replacements:
c0t1d0
```

You can choose one of these disks now, to replace `mydg02`.
Select "none" if you do not wish to select a replacement disk.

```
Choose a device, or select "none"
[<device>,none,q,?] (default: c0t1d0)
```

Note Do not choose the old disk drive as a replacement even though it appears in the selection list. If necessary, you can choose to initialize a new disk.

If you enter **none** because you intend to replace the physical disk, see the section [“Replacing a Failed or Removed Disk”](#) on page 93.

5. If you chose to replace the disk in step 4, press Return at the following prompt to confirm this:

```
VxVM NOTICE V-5-2-285 Requested operation is to remove mydg02 from
group mydg. The removed disk will be replaced with disk device
c0t1d0.
```

```
Continue with operation? [y,n,q,?] (default: y)
```

`vxdiskadm` displays the following messages to indicate that the original disk is being removed:

```
VxVM NOTICE V-5-2-265 Removal of disk mydg02 completed
successfully.
VxVM NOTICE V-5-2-260 Proceeding to replace mydg02 with device
c0t1d0.
```



6. You can now choose whether the disk is to be formatted as a CDS disk that is portable between different operating systems, or as a non-portable `hpdisk-format` disk:

Enter the desired format [`cdsdisk,hpdisk,q,?`] (default: `cdsdisk`)

Enter the format that is appropriate for your needs. In most cases, this is the default format, `cdsdisk`.

7. At the following prompt, `vxdiskadm` asks if you want to use the default private region size of 2048 blocks. Press Return to confirm that you want to use the default value, or enter a different value. (The maximum value that you can specify is 524288 blocks.)

Enter desired private region length [`<privlen>,q,?`] (default: 2048)

8. If one of more mirror plexes were moved from the disk, you are now prompted whether `FastResync` should be used to resynchronize the plexes:

Use FMR for plex resync? [`y,n,q,?`] (default: `n`) `y`

`vxdiskadm` displays the following success message:

```
VxVM NOTICE V-5-2-158 Disk replacement completed successfully.
```

9. At the following prompt, indicate whether you want to remove another disk (**y**) or return to the `vxdiskadm` main menu (**n**):

Remove another disk? [`y,n,q,?`] (default: `n`)

Note If removing a disk causes one or more volumes to be disabled, see the section, “Restarting a Disabled Volume” in the chapter “Recovery from Hardware Failure” in the *VERITAS Volume Manager Troubleshooting Guide*, for information on how to restart a disabled volume so that you can restore its data from a backup.

If you wish to move hot-relocate subdisks back to a replacement disk, see “[Configuring Hot-Relocation to Use Only Spare Disks](#)” on page 339.

Replacing a Failed or Removed Disk

Note You may need to run commands that are specific to the operating system or disk array when replacing a physical disk.

Use the following procedure after you have replaced a failed or removed disk with a new disk:

1. Select menu item 4 (Replace a failed or removed disk) from the `vxdiskadm` main menu.
2. At the following prompt, enter the name of the disk to be replaced (or enter **list** for a list of disks):

```
Replace a failed or removed disk
Menu: VolumeManager/Disk/ReplaceDisk
```

```
VxVM INFO V-5-2-479 Use this menu operation to specify a
replacement disk for a disk that you removed with the "Remove a
disk for replacement" menu operation, or that failed during use.
You will be prompted for a disk name to replace and a disk
device to use as a replacement.
```

```
You can choose an uninitialized disk, in which case the disk
will be initialized, or you can choose a disk that you have
already initialized using the Add or initialize a disk menu
operation.
```

```
Select a removed or failed disk [<disk>,list,q,?] mydg02
```

3. The `vxdiskadm` program displays the device names of the disk devices available for use as replacement disks. Your system may use a device name that differs from the examples. Enter the device name of the disk or press Return to select the default device:

```
The following devices are available as replacements:
c0t1d0 c1t1d0
```

```
You can choose one of these disks to replace mydg02.
Choose "none" to initialize another disk to replace mydg02.
```

```
Choose a device, or select "none"
[<device>,none,q,?] (default: c0t1d0)
```

4. Depending on whether the replacement disk was previously initialized, perform the appropriate step from the following:



- ❖ If the disk has not previously been initialized, press Return at the following prompt to replace the disk:

```
VxVM INFO V-5-2-378 The requested operation is to initialize disk
device c0t1d0 and to then use that device to replace the removed or
failed disk mydg02 in disk group mydg.
Continue with operation? [y,n,q,?] (default: y)
```

- ❖ If the disk has already been initialized, press Return at the following prompt to replace the disk:

```
VxVM INFO V-5-2-382 The requested operation is to use the
initialized device c0t1d0 to replace the removed or failed disk
mydg02 in disk group mydg.
Continue with operation? [y,n,q,?] (default: y)
```

5. You can now choose whether the disk is to be formatted as a CDS disk that is portable between different operating systems, or as a non-portable `hpdisk-format` disk:

```
Enter the desired format [cdsdisk,hpdisk,q,?] (default: cdsdisk)
```

Enter the format that is appropriate for your needs. In most cases, this is the default format, `cdsdisk`.

6. At the following prompt, `vxdiskadm` asks if you want to use the default private region size of 2048 blocks. Press Return to confirm that you want to use the default value, or enter a different value. (The maximum value that you can specify is 524288 blocks.)

```
Enter desired private region length [<privlen>,q,?] (default: 2048)
```

7. The `vxdiskadm` program then proceeds to replace the disk, and returns the following message on success:

```
VxVM NOTICE V-5-2-158 Disk replacement completed successfully.
```

At the following prompt, indicate whether you want to replace another disk (**y**) or return to the `vxdiskadm` main menu (**n**):

```
Replace another disk? [y,n,q,?] (default: n)
```

Enabling a Physical Disk

If you move a disk from one system to another during normal system operation, VxVM does not recognize the disk automatically. The enable disk task enables VxVM to identify the disk and to determine if this disk is part of a disk group. Also, this task re-enables access to a disk that was disabled by either the disk group deport task or the disk device disable (offline) task.

To enable a disk, use the following procedure:

1. Select menu item 9 (Enable (online) a disk device) from the `vxdiskadm` main menu.
2. At the following prompt, enter the device name of the disk to be enabled (or enter `list` for a list of devices):

```
Enable (online) a disk device
Menu: VolumeManager/Disk/OnlineDisk
```

```
VxVM INFO V-5-2-998 Use this operation to enable access to a disk
that was disabled with the "Disable (offline) a disk device"
operation.
```

You can also use this operation to re-scan a disk that may have been changed outside of the Volume Manager. For example, if a disk is shared between two systems, the Volume Manager running on the other system may have changed the disk. If so, you can use this operation to re-scan the disk.

NOTE: Many `vxdiskadm` operations re-scan disks without user intervention. This will eliminate the need to online a disk directly, except when the disk is directly offlined.

```
Select a disk device to enable [<address>,list,q,?] c0t2d0
vxdiskadm enables the specified device.
```

3. At the following prompt, indicate whether you want to enable another device (**y**) or return to the `vxdiskadm` main menu (**n**):

```
Enable another device? [y,n,q,?] (default: n)
```



Taking a Disk Offline

There are instances when you must take a disk offline. If a disk is corrupted, you must disable the disk before removing it. You must also disable a disk before moving the physical disk device to another location to be connected to another system.

Note Taking a disk offline is only useful on systems that support *hot-swap* removal and insertion of disks without needing to shut down and reboot the system.

To take a disk offline, use the `vxdiskadm` command:

1. Select menu item 10 (Disable (offline) a disk device) from the `vxdiskadm` main menu.
2. At the following prompt, enter the address of the disk you want to disable:

```
Disable (offline) a disk device
Menu: VolumeManager/Disk/OfflineDisk
```

```
VxVM INFO V-5-2-474 Use this menu operation to disable all access
to a disk device by the Volume Manager. This operation can be
applied only to disks that are not currently in a disk group. Use
this operation if you intend to remove a disk from a system without
rebooting.
```

```
NOTE: Many systems do not support disks that can be removed from
a system during normal operation. On such systems, the
offline operation is seldom useful.
```

```
Select a disk device to disable [<address>,list,q,?] c0t2d0
```

The `vxdiskadm` program disables the specified disk.

3. At the following prompt, indicate whether you want to disable another device (**y**) or return to the `vxdiskadm` main menu (**n**):

```
Disable another device? [y,n,q,?] (default: n)
```

Renaming a Disk

If you do not specify a VM disk name, VxVM gives the disk a default name when you add the disk to VxVM control. The VM disk name is used by VxVM to identify the location of the disk or the disk type. To change the disk name to reflect a change of use or ownership, use the following command:

```
# vxedit [-g diskgroup] rename old_diskname new_diskname
```

For example, you might want to rename disk `mydg03`, as shown in the following output from `vxdisk list`, to `mydg02`: #

```
# vxdisk list
DEVICE      TYPE          DISK          GROUP         STATUS
c0t0d0      auto:hpdisk   mydg01       mydg          online
c1t0d0      auto:hpdisk   mydg03       mydg          online
c1t1d0      auto:hpdisk   -            -            online
```

You would use the following command to rename the disk.

```
# vxedit -g mydg rename mydg03 mydg02
```

To confirm that the name change took place, use the `vxdisk list` command again:

```
# vxdisk list
DEVICE      TYPE          DISK          GROUP         STATUS
c0t0d0      auto:hpdisk   mydg01       mydg          online
c1t0d0      auto:hpdisk   mydg02       mydg          online
c1t1d0      auto:hpdisk   -            -            online
```

Note By default, VxVM names subdisk objects after the VM disk on which they are located. Renaming a VM disk does not automatically rename the subdisks on that disk.



Reserving Disks

By default, the `vxassist` command allocates space from any disk that has free space. You can reserve a set of disks for special purposes, such as to avoid general use of a particularly slow or a particularly fast disk.

To reserve a disk for special purposes, use the following command:

```
# vxedit [-g diskgroup] set reserve=on diskname
```

After you enter this command, the `vxassist` program does not allocate space from the selected disk unless that disk is specifically mentioned on the `vxassist` command line. For example, if `mydg03` is reserved, use the following command:

```
# vxassist [-g diskgroup] make vol03 20m mydg03
```

The `vxassist` command overrides the reservation and creates a 20 megabyte volume on `mydg03`. However, the command:

```
# vxassist -g mydg make vol04 20m
```

does not use `mydg03`, even if there is no free space on any other disk.

To turn off reservation of a disk, use the following command:

```
# vxedit [-g diskgroup] set reserve=off diskname
```

See the `vxedit(1M)` manual page for more information.

Displaying Disk Information

Before you use a disk, you need to know if it has been initialized and placed under VxVM control. You also need to know if the disk is part of a disk group, because you cannot create volumes on a disk that is not part of a disk group. The `vxdisk list` command displays device names for all recognized disks, the disk names, the disk group names associated with each disk, and the status of each disk.

To display information on all disks that are known to VxVM, use the following command:

```
# vxdisk list
```

VxVM returns a display similar to the following:

DEVICE	TYPE	DISK	GROUP	STATUS
c0t0d0	auto:hpdisk	mydg04	mydg	online
c1t0d0	auto:hpdisk	mydg03	mydg	online
c1t1d0	auto:hpdisk	-	-	online invalid
enc0_2	auto:hpdisk	mydg02	mydg	online
enc0_3	auto:hpdisk	mydg05	mydg	online
enc0_0	auto:hpdisk	-	-	online
enc0_1	auto:hpdisk	-	-	online

Note The phrase `online invalid` in the `STATUS` line indicates that a disk has not yet been added to VxVM control. These disks may or may not have been initialized by VxVM previously. Disks that are listed as `online` are already under VxVM control.

To display details on a particular disk defined to VxVM, use the following command:

```
# vxdisk list diskname
```

Displaying Disk Information with vxdiskadm

Displaying disk information shows you which disks are initialized, to which disk groups they belong, and the disk status. The `list` command displays device names for all recognized disks, the disk names, the disk group names associated with each disk, and the status of each disk.

To display disk information, use the following procedure:

1. Start the `vxdiskadm` program, and select `list` (List disk information) from the main menu.
2. At the following display, enter the address of the disk you want to see, or enter **all** for a list of all disks:

```
List disk information
Menu: VolumeManager/Disk/ListDisk
```

```
VxVM INFO V-5-2-475 Use this menu operation to display a list of
disks. You can also choose to list detailed information about the
disk at a specific disk device address.
```

```
Enter disk device or "all" [<address>,all,q,?] (default: all)
```

- ◆ If you enter **all**, VxVM displays the device name, disk name, group, and status.
- ◆ If you enter the address of the device for which you want information, complete disk information (including the device name, the type of disk, and information about the public and private areas of the disk) is displayed.

Once you have examined this information, press Return to return to the main menu.





Administering Dynamic Multipathing (DMP)

3

Note You need a full license to use this feature.

The Dynamic Multipathing (DMP) feature of VERITAS Volume Manager (VxVM) provides greater reliability and performance by using path failover and load balancing. This feature is available for multiported disk arrays from various vendors. See the *VERITAS Volume Manager Hardware Notes* for information about supported disk arrays.

How DMP Works

Multiported disk arrays can be connected to host systems through multiple paths. To detect the various paths to a disk, DMP uses a mechanism that is specific to each supported array type. DMP can also differentiate between different enclosures of a supported array type that are connected to the same host system.

See “[Discovering and Configuring Newly Added Disk Devices](#)” on page 63 for a description of how to make newly added disk hardware known to a host system.

The multipathing policy used by DMP depends on the characteristics of the disk array:

- ◆ An *Active/Passive* array (*A/P array*) allows access to its LUNs (*logical units*; real disks or virtual disks created using hardware) via the *primary* (active) path on a single controller (also known as an *access port* or a *storage processor*) during normal operation.

In *implicit failover mode* (or *autotrespass mode*), an A/P array automatically fails over by scheduling I/O to the *secondary* (passive) path on a separate controller if the primary path fails. This passive port is not used for I/O until the active port fails. In A/P arrays, path failover can occur for a single LUN if I/O fails on the primary path.

For Active/Passive arrays with *LUN group failover* (*A/PG arrays*), a group of LUNs that are connected through a controller is treated as a single failover entity. Unlike A/P arrays, failover occurs at the controller level, and not for individual LUNs. The primary and secondary controller are each connected to a separate group of LUNs. If a single LUN in the primary controller’s LUN group fails, all LUNs in that group fail over to the secondary controller.



Active/Passive arrays in *explicit failover mode* (or *non-autotrespass mode*) are termed *A/PF arrays*. DMP issues the appropriate low-level command to make the LUNs fail over to the secondary path.

A/P-C, A/PF-C and A/PG-C arrays are variants of the A/P, AP/F and A/PG array types that support concurrent I/O and load balancing by having multiple primary paths into a controller. This functionality is provided by a controller with multiple ports, or by the insertion of a SAN hub or switch between an array and a controller. Failover to the secondary (passive) path occurs only if all the active primary paths fail.

- ◆ An *Active/Active* disk array (*A/A arrays*) permits several paths to be used concurrently for I/O. Such arrays allow DMP to provide greater I/O throughput by balancing the I/O load uniformly across the multiple paths to the LUNs. In the event that one path fails, DMP automatically routes I/O over the other available paths.

VxVM uses *DMP metanodes* (*DMP nodes*) to access disk devices connected to the system. For each disk in a supported array, DMP maps one node to the set of paths that are connected to the disk. Additionally, DMP associates the appropriate multipathing policy for the disk array with the node. For disks in an unsupported array, DMP maps a separate node to each path that is connected to a disk. The raw and block devices for the nodes are created in the directories `/dev/vx/rdmp` and `/dev/vx/dmp` respectively.

See the figure, “[How DMP Represents Multiple Physical Paths to a Disk as One Node](#)” on page 102, for an illustration of how DMP sets up a node for a disk in a supported disk array.

How DMP Represents Multiple Physical Paths to a Disk as One Node

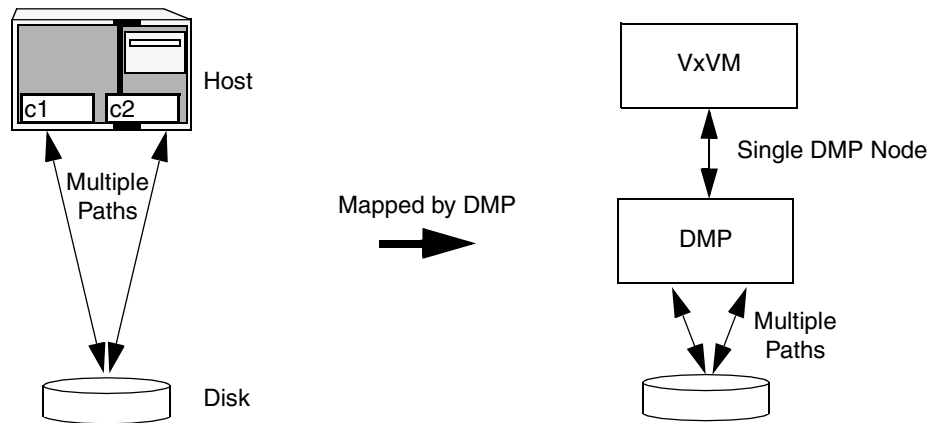

As described in [“Enclosure-Based Naming”](#) on page 6, VxVM implements a disk device naming scheme that allows you to recognize to which array a disk belongs. The figure, [“Example of Multipathing for a Disk Enclosure in a SAN Environment”](#) on page 103, shows that two paths, `c1t99d0` and `c2t99d0`, exist to a single disk in the enclosure, but VxVM uses the single DMP node, `enc0_0`, to access it.

Example of Multipathing for a Disk Enclosure in a SAN Environment

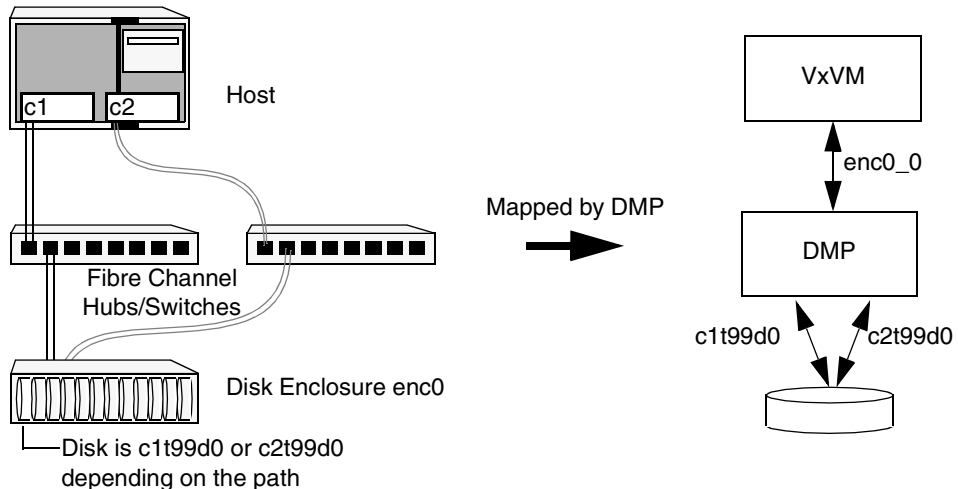

See [“Changing the Disk-Naming Scheme”](#) on page 72 for details of how to change the naming scheme that VxVM uses for disk devices.

Note The persistent device naming feature, introduced in VxVM 4.1, makes the names of disk devices (DMP node names) persistent across system reboots. If operating system-based naming is selected, each disk name is usually set to the name of one of the paths to the disk. After hardware reconfiguration and a subsequent reboot, the operating system may generate different names for the paths to the disks. As DDL assigns persistent disk names using the persistent device name database that was generated during a previous boot session, a disk name may no longer correspond to an actual path to the disk. Since DMP device node names are arbitrary, this does not prevent the disks from being used. See [“Regenerating the Persistent Device Name Database”](#) on page 74 for details of how to regenerate the persistent device name database, and restore the relationship between the disk and path names.

See [“Discovering and Configuring Newly Added Disk Devices”](#) on page 63 for a description of how to make newly added disk hardware known to a host system.



Path Failover Mechanism

The DMP feature of VxVM enhances system reliability when used with multiported disk arrays. In the event of the loss of one connection to the disk array, DMP automatically selects the next available I/O path for I/O requests dynamically without action from the administrator.

DMP is also informed when you repair or restore a connection, and when you add or remove devices after the system has been fully booted (provided that the operating system recognizes the devices correctly).

Load Balancing

By default, DMP uses the *balanced path mechanism* to provide load balancing across paths for Active/Active, A/P-C, A/PF-C and A/PG-C disk arrays. Load balancing maximizes I/O throughput by using the total bandwidth of all available paths. Sequential I/O starting within a certain range is sent down the same path in order to benefit from disk track caching. Large sequential I/O that does not fall within the range is distributed across the available paths to reduce the overhead on any one path.

For Active/Passive disk arrays, I/O is sent down the primary path. If the primary path fails, I/O is switched over to the other available primary paths or secondary paths. As the continuous transfer of ownership of LUNs from one controller to another results in severe I/O slowdown, load balancing across paths is not performed for Active/Passive disk arrays unless they support concurrent I/O.

Note Both paths of an Active/Passive array are not considered to be on different controllers when mirroring across controllers (for example, when creating a volume using `vxassist make` specified with the `mirror=ctlr` attribute).

For A/P-C, A/PF-C and A/PG-C arrays, load balancing is performed across all the currently active paths as is done for Active/Active arrays.

You can use the `vxdmppadm` command to change the I/O policy for the paths to an enclosure or disk array as described in [“Specifying the I/O Policy”](#) on page 120.

DMP in a Clustered Environment

Note You need an additional license to use the cluster feature of VxVM.

In a clustered environment where Active/Passive type disk arrays are shared by multiple hosts, all nodes in the cluster must access the disk via the same physical path. Accessing a disk via multiple paths simultaneously can severely degrade I/O performance (sometimes referred to as the *ping-pong effect*). Path failover on a single cluster node is also coordinated across the cluster so that all the nodes continue to share the same physical path.

Prior to release 4.1 of VxVM, the clustering and DMP features could not handle automatic failback in A/P arrays when a path was restored, and did not support failback for explicit failover mode arrays. Failback could only be implemented manually by running the `vxdctl enable` command on each cluster node after the path failure had been corrected. In release 4.1, failback is now an automatic cluster-wide operation that is coordinated by the master node. Automatic failback in explicit failover mode arrays is also handled by issuing the appropriate low-level command. If required, this feature can be disabled by selecting the “no failback” option that is defined in the array policy module (APM) for an array.

Note Support for automatic failback of an A/P array requires that an appropriate ASL (and APM, if required) is available for the array, and has been installed on the system. See “[Administering the Device Discovery Layer](#)” on page 66, “[Configuring Array Policy Modules](#)” on page 129, and the *VERITAS Volume Manager Hardware Notes* for more information.

For Active/Active type disk arrays, any disk can be simultaneously accessed through all available physical paths to it. In a clustered environment, the nodes do not all need to access a disk via the same physical path.

Enabling or Disabling Controllers with Shared Disk Groups

VxVM does not allow enabling or disabling of controllers connected to a disk that is part of a shared VERITAS Volume Manager disk group.

For example, consider a disk array, containing all or part of a shared disk group, that is connected through a controller on each of the cluster nodes. In such a situation, the `vxdmpadm enable` and `disable` operations fail when applied to the controller on any of the nodes, and the following error message is displayed:

```
VxVM vxio ERROR V-5-1-3490 Operation not supported for shared disk arrays.
```



Disabling and Enabling Multipathing for Specific Devices

You can use `vxdiskadm` menu options 17 and 18 to disable or enable multipathing. These menu options also allow you to exclude devices from or include devices in the view of VxVM. For more information, see “[Disabling Multipathing and Making Devices Invisible to VxVM](#)” on page 106 and “[Enabling Multipathing and Making Devices Visible to VxVM](#)” on page 107.

Disabling Multipathing and Making Devices Invisible to VxVM

Note Some of the operations described in this section require a reboot of the system.

1. Select menu task 17 (Prevent multipathing/Suppress devices from VxVM's view) from the `vxdiskadm` main menu to prevent a device from being multipathed by the VxVM DMP driver (`vxdmp`), or to exclude a device from the view of VxVM. You are prompted to confirm whether you want to continue.
2. Select the operation you want to perform from the displayed list:
 - 1 Suppress all paths through a controller from VxVM's view
 - 2 Suppress a path from VxVM's view
 - 3 Suppress disks from VxVM's view by specifying a VID:PID combination
 - 4 Suppress all but one paths to a disk
 - 5 Prevent multipathing of all disks on a controller by VxVM
 - 6 Prevent multipathing of a disk by VxVM
 - 7 Prevent multipathing of disks by specifying a VID:PID combination
 - 8 List currently suppressed/non-multipathed devices
 - ? Display help about menu
 - ?? Display help about the menuing system
 - q Exit from menus

Help text and examples are provided onscreen for all the menu items.

- ❖ Select option 1 to exclude all paths through the specified controller from the view of VxVM. These paths remain in the disabled state until the next reboot, or until the paths are re-included.
- ❖ Select option 2 to exclude specified paths from the view of VxVM.



- ❖ Select option 3 to exclude disks from the view of VxVM that match a specified Vendor ID and Product ID.
- ❖ Select option 4 to define a pathgroup for disks that are not multipathed by VxVM. (A pathgroup explicitly defines alternate paths to the same disk.) Only one path is made visible to VxVM.
- ❖ Select option 5 to disable multipathing for all disks on a specified controller.
- ❖ Select option 6 to disable multipathing for specified paths. The disks that correspond to a specified path are claimed in the OTHER_DISKS category and are not multipathed.
- ❖ Select option 7 to disable multipathing for disks that match a specified Vendor ID and Product ID. The disks that correspond to a specified Vendor ID and Product ID combination are claimed in the OTHER_DISKS category and are not multipathed.
- ❖ Select option 8 to list the devices that are currently suppressed or not multipathed.

Enabling Multipathing and Making Devices Visible to VxVM

Note Some of the operations described in this section require a reboot of the system.

1. Select menu item 18 (Allow multipathing/Unsuppress devices from VxVM's view) from the vxdiskadm main menu to re-enable multipathing for a device, or to make a device visible to VxVM again. You are prompted to confirm whether you want to continue.
2. Select the operation you want to perform from the displayed list:
 - 1 Unsuppress all paths through a controller from VxVM's view
 - 2 Unsuppress a path from VxVM's view
 - 3 Unsuppress disks from VxVM's view by specifying a VID:PID combination
 - 4 Remove a pathgroup definition
 - 5 Allow multipathing of all disks on a controller by VxVM
 - 6 Allow multipathing of a disk by VxVM
 - 7 Allow multipathing of disks by specifying a VID:PID combination
 - 8 List currently suppressed/non-multipathed devices
 - ? Display help about menu
 - ?? Display help about the menuing system
 - q Exit from menus



- ❖ Select option 1 to make all paths through a specified controller visible to VxVM.
- ❖ Select option 2 to make specified paths visible to VxVM.
- ❖ Select option 3 to make disks visible to VxVM that match a specified Vendor ID and Product ID.
- ❖ Select option 4 to remove a pathgroup definition. (A pathgroup explicitly defines alternate paths to the same disk.) Once a pathgroup has been removed, all paths that were defined in that pathgroup become visible again.
- ❖ Select option 5 to enable multipathing for all disks that have paths through the specified controller.
- ❖ Select option 6 to enable multipathing for specified paths.
- ❖ Select option 7 to enable multipathing for disks that match a specified Vendor ID and Product ID.
- ❖ Select option 8 to list the devices that are currently suppressed or not multipathed.

Enabling and Disabling Input/Output (I/O) Controllers

DMP allows you to turn off I/O to a host I/O controller so that you can perform administrative operations. This feature can be used for maintenance of controllers attached to the host or of disk arrays supported by VxVM. I/O operations to the host I/O controller can be turned back on after the maintenance task is completed. You can accomplish these operations using the `vxdmpadm` command provided with VxVM.

In Active/Active type disk arrays, VxVM uses a balanced path mechanism to schedule I/O to multipathed disks. As a result, I/O may go through any available path at any given point in time. For example, if a system has an Active/Active storage array and you need to change an interface board that is connected to this disk array (if supported by the hardware), you can use the `vxdmpadm` command to list the host I/O controllers that are connected to the interface board. Disable the host I/O controllers to stop further I/O to the disks that are accessed through the interface board. You can then replace the board without causing disruption to any ongoing I/O to disks in the disk array.

In Active/Passive type disk arrays, VxVM schedules I/O to use the primary path until a failure is encountered. To change an interface card on the disk array or a card on the host (if supported by the hardware) that is connected to the disk array, disable I/O operations to the host I/O controllers. This shifts all I/O over to an active secondary path or to an active primary path on another I/O controller so that you can change the hardware.

After the operation is over, you can use `vxdmpadm` to re-enable the paths through the controllers.

Note These operations are not supported for controllers that are used to access disk arrays on which cluster-shareable disk groups are configured.

Displaying DMP Database Information

You can use the `vxdmpadm` command to list DMP database information and perform other administrative tasks. This command allows you to list all controllers that are connected to disks, and other related information that is stored in the DMP database. You can use this information to locate system hardware, and to help you decide which controllers need to be enabled or disabled.

The `vxdmpadm` command also provides useful information such as disk array serial numbers, which DMP devices (disks) are connected to the disk array, and which paths are connected to a particular controller.

For more information, see “[Administering DMP Using vxdmpadm](#)” on page 111.



Displaying Multipaths to a VM Disk

The `vxdisk` command is used to display the multipathing information for a particular metadevice. The metadevice is a device representation of a particular physical disk having multiple physical paths from the I/O controller of the system. In VxVM, all the physical disks in the system are represented as metadevices with one or more physical paths.

You can use the `vxdisk path` command to display the relationships between the device paths, disk access names, disk media names and disk groups on a system as shown here:

```
# vxdisk path
SUBPATH      DANAME      DMNAME      GROUP      STATE
c1t0d0       c1t0d0      mydg01      mydg       ENABLED
c4t0d0       c1t0d0      mydg01      mydg       ENABLED
c1t1d0       c1t1d0      mydg02      mydg       ENABLED
c4t1d0       c1t1d0      mydg02      mydg       ENABLED
.
.
.
```

This shows that two paths exist to each of the two disks, `mydg01` and `mydg02`, and also indicates that each disk is in the `ENABLED` state.

To view multipathing information for a particular metadevice, use the following command:

```
# vxdisk list devicename
```

For example, to view multipathing information for `c1t0d3`, use the following command:

```
# vxdisk list c1t0d3
```

Typical output from the `vxdisk list` command is as follows:

```
Device:      c1t0d3
devicetag:   c1t0d3
type:        simple
hostid:      zort
disk:        name=mydg04 id=962923652.362193.zort
timeout:     30
group:       name=mydg id=962212937.1025.zort
info:        privoffset=128
flags:       online ready private autoconfig autoimport imported
pubpaths:    block=/dev/vx/dmp/c1t0d3
privpaths:   char=/dev/vx/rdmp/c1t0d3
version:     2.1
iosize:      min=1024 (bytes) max=64 (blocks)
public:      slice=0 offset=1152 len=4101723
private:     slice=0 offset=128 len=1024
```

```

update:      time=962923719 seqno=0.7
headers:    0 248
configs:    count=1 len=727
logs:       count=1 len=110
Defined regions:
config  priv 000017-000247[000231]:copy=01 offset=000000 disabled
config  priv 000249-000744[000496]:copy=01 offset=000231 disabled
log     priv 000745-000854[000110]:copy=01 offset=000000 disabled
lockrgn priv 000855-000919[000065]: part=00 offset=000000
Multipathing information:
numpaths:  2
c1t0d3 state=enabled  type=secondary
c4t1d3 state=disabled type=primary

```

In the Multipathing information section of this output, the numpaths line shows that there are 2 paths to the device, and the following two lines show that the path to c1t0d3 is active (state=enabled) and that the other path c4t1d3 has failed (state=disabled).

The type field is shown for disks on Active/Passive type disk arrays such as the EMC CLARiiON, Hitachi HDS 9200 and 9500, Sun StorEdge 6xxx , and Sun StorEdge T3 array. This field indicates the *primary* and *secondary* paths to the disk.

The type field is not displayed for disks on Active/Active type disk arrays such as the EMC Symmetrix, Hitachi HDS 99xx and Sun StorEdge 99xx Series, and IBM ESS Series. Such arrays have no concept of primary and secondary paths.

Administering DMP Using vxdmppadm

The vxdmppadm utility is a command line administrative interface to the DMP feature of VxVM. You can use the vxdmppadm utility to perform the following tasks.

- ◆ Retrieve the name of the DMP device corresponding to a particular path.
- ◆ Display the members of a LUN group.
- ◆ List all paths under a DMP device.
- ◆ List all controllers connected to disks attached to the host.
- ◆ List all the paths connected to a particular controller.
- ◆ Set the attributes of the paths to an enclosure.
- ◆ Set the I/O policy that is used for the paths to an enclosure.
- ◆ Enable or disable a host controller on the system.
- ◆ Rename an enclosure.



- ◆ Control the operation of the DMP restore daemon.

The following sections cover these tasks in detail along with sample output. For more information, see the `vxddpdm(1M)` manual page.

Retrieving Information About a DMP Node

The following command displays the DMP node that controls a particular physical path:

```
# vxddpdm getdmpnode nodename=c3t2d1
```

The physical path is specified by argument to the `nodename` attribute, which must be a valid path listed in the `/dev/rdisk` directory.

The above command displays output such as the following:

NAME	STATE	ENCLR-TYPE	PATHS	ENBL	DSBL	ENCLR-NAME
c3t2d1	ENABLED	ACME	2	2	0	enc0

Use the `enclosure` attribute with `getdmpnode` to obtain a list of all DMP nodes for the specified enclosure.

```
# vxddpdm getdmpnode enclosure=enc0
```

NAME	STATE	ENCLR-TYPE	PATHS	ENBL	DSBL	ENCLR-NAME
c2t1d0	ENABLED	ACME	2	2	0	enc0
c2t1d1	ENABLED	ACME	2	2	0	enc0
c2t1d2	ENABLED	ACME	2	2	0	enc0
c2t1d3	ENABLED	ACME	2	2	0	enc0

Displaying the Members of a LUN Group

The following command displays the DMP nodes that are in the same LUN group as a specified DMP node:

```
# vxddpdm getlungroup dmpnodename=c11t0d10
```

The above command displays output such as the following:

NAME	STATE	ENCLR-TYPE	PATHS	ENBL	DSBL	ENCLR-NAME
c11t0d8	ENABLED	ACME	2	2	0	enc1
c11t0d9	ENABLED	ACME	2	2	0	enc1
c11t0d10	ENABLED	ACME	2	2	0	enc1
c11t0d11	ENABLED	ACME	2	2	0	enc1

Displaying All Paths Controlled by a DMP Node

The following command displays the paths controlled by the specified DMP node:

```
# vxddmpadm getsubpaths dmpnodename=c2t1d0
```

NAME	STATE [-]	PATH-TYPE [-]	CTLR-NAME	ENCLR-TYPE	ENCLR-NAME	ATTRS
c2t1d0	ENABLED	PRIMARY	c2	ACME	enc0	-
c3t2d0	ENABLED	SECONDARY	c3	ACME	enc0	-

The specified DMP node must be a valid node in the `/dev/vx/rddmp` directory.

The state of a path that is currently enabled and available for I/O is shown as `ENABLED (A)`:

```
# vxddmpadm getsubpaths dmpnodename=c2t66d0
```

NAME	STATE [A]	PATH-TYPE [M]	CTLR-NAME	ENCLR-TYPE	ENCLR-NAME	ATTRS
c2t66d0	ENABLED (A)	PRIMARY	c2	ACME	enc0	-
c1t66d0	ENABLED	PRIMARY	c1	ACME	enc0	-

For A/A arrays, all enabled paths that are available for I/O are shown as `ENABLED (A)`.

For A/P arrays in which the I/O policy is set to `singleactive`, only one path is shown as `ENABLED (A)`. The other paths are enabled but not available for I/O. If the I/O policy is not set to `singleactive`, DMP can use a group of paths (all primary or all secondary) for I/O, which are shown as `ENABLED (A)`. See [“Specifying the I/O Policy”](#) on page 120 for more information.

You can also use `getsubpaths` to obtain all paths through a particular host disk controller:

```
# vxddmpadm getsubpaths ctlr=c2
```

NAME	STATE [-]	PATH-TYPE [-]	CTLR-NAME	ENCLR-TYPE	ENCLR-NAME	ATTRS
c2t1d0	ENABLED	PRIMARY	c2t1d0	ACME	enc0	-
c2t2d0	ENABLED	PRIMARY	c2t2d0	ACME	enc0	-
c2t3d0	ENABLED	SECONDARY	c2t3d0	ACME	enc0	-
c2t4d0	ENABLED	SECONDARY	c2t4d0	ACME	enc0	-



Listing Information About Host I/O Controllers

The following command lists attributes of all host I/O controllers on the system:

```
# vxdmpadm listctlr all
```

CTLR-NAME	ENCLR-TYPE	STATE	ENCLR-NAME
c1	OTHER	ENABLED	other0
c2	X1	ENABLED	jbod0
c3	ACME	ENABLED	enc0
c4	ACME	ENABLED	enc0

This form of the command lists controllers belonging to a specified enclosure and enclosure type:

```
# vxdmpadm listctlr enclosure=enc0 type=ACME
```

CTLR-NAME	ENCLR-TYPE	STATE	ENCLR-NAME
c2	ACME	ENABLED	enc0
c3	ACME	ENABLED	enc0

Listing Information About Enclosures

To display the attributes of a specified enclosure, use the following command:

```
# vxdmpadm listenclosure enc0
```

ENCLR_NAME	ENCLR_TYPE	ENCLR_SNO	STATUS	ARRAY_TYPE
enc0	A3	60020f20000001a90000	CONNECTED	A/P

The following command lists attributes for all enclosures in a system:

```
# vxdmpadm listenclosure all
```

The following is example output from this command:

ENCLR_NAME	ENCLR_TYPE	ENCLR_SNO	STATUS	ARRAY_TYPE
Disk	Disk	DISKS	CONNECTED	Disk
ANA0	ACME	508002000001d660	CONNECTED	A/A
enc0	A3	60020f20000001a90000	CONNECTED	A/P



Displaying Information About TPD-Controlled Devices

The third-party driver (TPD) coexistence feature allows I/O that is controlled by third-party multipathing drivers to bypass DMP while retaining the monitoring capabilities of DMP. The following commands allow you to display the paths that DMP has discovered for a given TPD device, and the TPD device that corresponds to a given TPD-controlled node discovered by DMP:

```
# vxddmpadm getsubpaths tpdnodename=TPD_node_name
# vxddmpadm gettpdnode nodename=DMP_node_name
```

See “[Changing Device Naming for TPD-Controlled Enclosures](#)” on page 72 for information on how to select whether OS or TPD-based device names are displayed.

For example, consider the following disks in an EMC Symmetrix array controlled by PowerPath, which are known to DMP:

```
# vxddisk list
DEVICE          TYPE          DISK          GROUP         STATUS
emcpower10     auto:sliced   disk1         ppdg          online
emcpower11     auto:sliced   disk2         ppdg          online
emcpower12     auto:sliced   disk3         ppdg          online
emcpower13     auto:sliced   disk4         ppdg          online
emcpower14     auto:sliced   disk5         ppdg          online
emcpower15     auto:sliced   disk6         ppdg          online
emcpower16     auto:sliced   disk7         ppdg          online
emcpower17     auto:sliced   disk8         ppdg          online
emcpower18     auto:sliced   disk9         ppdg          online
emcpower19     auto:sliced   disk10        ppdg          online
```

The following command displays the paths that DMP has discovered, and which correspond to the PowerPath-controlled node, emcpower10:

```
# vxddmpadm getsubpaths tpdnodename=emcpower10
NAME          TPDNODENAME  PATH-TYPE [-]  DMP-NODENAME  ENCLR-TYPE  ENCLR-NAME
=====
c7t0d10     emcpower10s2 -                emcpower10  EMC          EMC0
c6t0d10     emcpower10s2 -                emcpower10  EMC          EMC0
```

Conversely, the next command displays information about the PowerPath node that corresponds to the path, c7t0d10, discovered by DMP:

```
# vxddmpadm gettpdnode nodename=c7t0d10
NAME          STATE        PATHS         ENCLR-TYPE    ENCLR-NAME
=====
emcpower10s2  ENABLED      2             EMC           EMC0
```



Gathering and Displaying I/O Statistics

You can use the `vxddmpadm iostat` command to gather and display I/O statistics for a specified DMP node, enclosure or path.

To enable the gathering of statistics, enter this command:

```
# vxddmpadm iostat start [memory=size]
```

To reset the I/O counters to zero, use this command:

```
# vxddmpadm iostat reset
```

The `memory` attribute can be used to limit the maximum amount of memory that is used to record I/O statistics for each CPU. The default limit is 32k (32 kilobytes) per CPU.

To display the accumulated statistics at regular intervals, use the following command:

```
# vxddmpadm iostat show {all | dmpnodename=dmp-node | \  
enclosure=enclr-name | pathname=path_name}  
[interval=seconds [count=N]]
```

This command displays I/O statistics for all controllers (`all`), or for a specified DMP node, enclosure or path. The statistics displayed are the CPU usage and amount of memory per CPU used to accumulate statistics, the number of read and write operations, the number of blocks read and written, and the average time in milliseconds per read and write operation.

The `interval` and `count` attributes may be used to specify the interval in seconds between displaying the I/O statistics, and the number of lines to be displayed. The actual interval may be smaller than the value specified if insufficient memory is available to record the statistics.

To disable the gathering of statistics, enter this command:

```
# vxddmpadm iostat stop
```

Examples of Using the vxddmpadm iostat Command

The follow is an example session using the `vxddmpadm iostat` command. The first command enables the gathering of I/O statistics:

```
# vxddmpadm iostat start
```

The next command displays the current statistics including the accumulated total numbers of read and write operations and kilobytes read and written, on all paths:

```
# vxddmpadm iostat show all
      cpu usage = 7952us      per cpu memory = 8192b
      OPERATIONS          KBYTES          AVG TIME (ms)
PATHNAME  READS    WRITES    READS    WRITES    READS    WRITES
c0t0d0    1088      0         557056   0         0.009542 0.000000
c2t118d0   87        0         44544    0         0.001194 0.000000
c3t118d0   0         0          0        0         0.000000 0.000000
c2t122d0   87        0         44544    0         0.007265 0.000000
c3t122d0   0         0          0        0         0.000000 0.000000
c2t115d0   87        0         44544    0         0.001200 0.000000
c3t115d0   0         0          0        0         0.000000 0.000000
c2t103d0   87        0         44544    0         0.007315 0.000000
c3t103d0   0         0          0        0         0.000000 0.000000
c2t102d0   87        0         44544    0         0.001132 0.000000
c3t102d0   0         0          0        0         0.000000 0.000000
c2t121d0   87        0         44544    0         0.000997 0.000000
c3t121d0   0         0          0        0         0.000000 0.000000
c2t112d0   87        0         44544    0         0.001559 0.000000
c3t112d0   0         0          0        0         0.000000 0.000000
c2t96d0    87        0         44544    0         0.007057 0.000000
c3t96d0    0         0          0        0         0.000000 0.000000
c2t106d0   87        0         44544    0         0.007247 0.000000
c3t106d0   0         0          0        0         0.000000 0.000000
c2t113d0   87        0         44544    0         0.007235 0.000000
c3t113d0   0         0          0        0         0.000000 0.000000
c2t119d0   87        0         44544    0         0.001390 0.000000
c3t119d0   0         0          0        0         0.000000 0.000000
```

The following command changes the amount of memory that vxddmpadm can use to accumulate the statistics:

```
# vxddmpadm iostat start memory=4096
```

The displayed statistics can be filtered by path name, DMP node name, and enclosure name (note that the per-CPU memory has changed following the previous command):

```
# vxddmpadm iostat show pathname=c3t115d0
      cpu usage = 8132us      per cpu memory = 4096b
      OPERATIONS          BYTES          AVG TIME (ms)
PATHNAME  READS    WRITES    READS    WRITES    READS    WRITES
c3t115d0   0         0          0        0         0.000000 0.000000
```



```

# vxddmpadm iostat show dmpnodename=c0t0d0
          cpu usage = 8501us      per cpu memory = 4096b
          OPERATIONS              BYTES              AVG TIME(ms)
PATHNAME  READS    WRITES    READS    WRITES    READS    WRITES
c0t0d0    1088      0        557056      0    0.009542  0.000000

# vxddmpadm iostat show enclosure=Disk
          cpu usage = 8626us      per cpu memory = 4096b
cpu usage = 8501us      per cpu memory = 4096b
          OPERATIONS              BYTES              AVG TIME(ms)
PATHNAME  READS    WRITES    READS    WRITES    READS    WRITES
c0t0d0    1088      0        557056      0    0.009542  0.000000

```

You can also specify the number of times to display the statistics and the time interval. Here the incremental statistics for a path are displayed twice with a 2-second interval:

```

# vxddmpadm iostat show pathname=c3t115d0 interval=2 count=2
          cpu usage = 8195us      per cpu memory = 4096b
          OPERATIONS              BYTES              AVG TIME(ms)
PATHNAME  READS    WRITES    READS    WRITES    READS    WRITES
c3t115d0  0        0         0         0         0.000000  0.000000

          cpu usage = 59us       per cpu memory = 4096b
          OPERATIONS              BYTES              AVG TIME(ms)
PATHNAME  READS    WRITES    READS    WRITES    READS    WRITES
c3t115d0  0        0         0         0         0.000000  0.000000

```

Setting the Attributes of the Paths to an Enclosure

You can use the `vxddmpadm setattr` command to set the following attributes of the paths to an enclosure or disk array:

- ◆ `active`

Changes a *standby* (failover) path to an active path. The example below specifies an active path for an A/P-C disk array:

```
# vxddmpadm setattr path c2t10d0 pathtype=active
```

- ◆ `nomannual`

Restores the original primary or secondary attributes of a path. This example restores the attributes for a path to an A/P disk array:

```
# vxddmpadm setattr path c3t10d0 pathtype=nomannual
```

◆ `nopreferred`

Restores the normal priority of a path. The following example restores the default priority to a path:

```
# vxddmadmin setattr path c1t20d0 pathtype=nopreferred
```

◆ `preferred [priority=N]`

Specifies a path as preferred, and optionally assigns a priority number to it. If specified, the priority number must be an integer that is greater than or equal to one. Higher priority numbers indicate that a path is able to carry a greater I/O load.

Note Setting a priority for path does not change the I/O policy. The I/O policy must be set independently as described in “[Specifying the I/O Policy](#)” on page 120.

This example first sets the I/O policy to `priority` for an Active/Active disk array, and then specifies a preferred path with an assigned priority of 2:

```
# vxddmadmin setattr enclosure enc0 iopolicy=priority
# vxddmadmin setattr path c1t20d0 pathtype=preferred \
  priority=2
```

◆ `primary`

Defines a path as being the primary path for an Active/Passive disk array. The following example specifies a primary path for an A/P disk array:

```
# vxddmadmin setattr path c3t10d0 pathtype=primary
```

◆ `secondary`

Defines a path as being the secondary path for an Active/Passive disk array. This example specifies a secondary path for an A/P disk array:

```
# vxddmadmin setattr path c4t10d0 pathtype=secondary
```

◆ `standby`

Marks a standby (failover) path that it is not used for normal I/O scheduling. This path is used if there are no active paths available for I/O. The next example specifies a standby path for an A/P-C disk array:

```
# vxddmadmin setattr path c2t10d0 pathtype=standby
```



Displaying the I/O Policy

To display the current and default settings of the I/O policy for an enclosure, array or array type, use the `vxdmppadm getattr` command.

The following example displays the default and current setting of `iopolicy` for JBOD disks:

```
# vxdmppadm getattr enclosure Disk iopolicy
ENCLR_NAME      DEFAULT      CURRENT
-----
Disk            balanced    MinimumQ
```

The next example displays the setting of `partitionsize` for the enclosure `enc0`, on which the `balanced` I/O policy with a partition size of 2MB has been set:

```
# vxdmppadm getattr enclosure enc0 partitionsize
ENCLR_NAME      DEFAULT      CURRENT
-----
enc0            1024        2048
```

Specifying the I/O Policy

You can use the `vxdmppadm setattr` command to change the I/O policy for distributing I/O load across multiple paths to a disk array or enclosure. You can set policies for an enclosure (for example, `HDS01`), for all enclosures of a particular type (such as `HDS`), or for all enclosures of a particular array type (`A/A` for Active/Active, or `A/P` for Active/Passive).

Note Starting with release 4.1 of VxVM, I/O policies are recorded in the file `/etc/vx/dmppolicy.info`, and are persistent across reboots of the system. Do not edit this file yourself.

The following policies may be set:

- ◆ `adaptive`

This policy attempts to maximize overall I/O throughput from/to the disks by dynamically scheduling I/O on the paths. It is suggested for use where I/O loads can vary over time. For example, I/O from/to a database may exhibit both long transfers (table scans) and short transfers (random look ups). The policy is also useful for a SAN environment where different paths may have different number of hops. No further configuration is possible as this policy is automatically managed by DMP.

In this example, the adaptive I/O policy is set for the enclosure enc1:

```
# vxddmpadm setattr enclosure enc1 iopolicy=adaptive
```

◆ `balanced [partitionsize=size]`

This policy is designed to optimize the use of caching in disk drives and RAID controllers, and is the default policy for A/A arrays. The size of the cache typically ranges from 120KB to 500KB or more, depending on the characteristics of the particular hardware. During normal operation, the disks (or LUNs) are logically divided into a number of regions (or *partitions*), and I/O from/to a given region is sent on only one of the active paths. Should that path fail, the workload is automatically redistributed across the remaining paths.

You can use the `size` argument to the `partitionsize` attribute to specify the partition size. The partition size in blocks is adjustable in powers of 2 from 2 up to 2^{31} as illustrated in the table below:

Partition Size in Blocks	Equivalent Size in Bytes
2	2,048
4	4,096
8	8,192
16	16,384
32	32,768
64	65,536
128	131,072
256	262,144
512	524,288
1024 (default)	1,048,576
2048	2,097,152
4096	4,194,304

The default value for the partition size is 1024 blocks (1MB). A value that is not a power of 2 is silently rounded down to the nearest acceptable value. Specifying a partition size of 0 is equivalent to the default partition size of 1024 blocks (1MB). For example, the suggested partition size for an Hitachi HDS 9960 A/A array is from 16,384 to 65,536 blocks (16MB to 64MB) for an I/O activity pattern that consists mostly of sequential reads or writes.



Note The benefit of this policy is lost if the value is set larger than the cache size.

The default value can be changed by adjusting the value of a tunable parameter (see “[dmp_pathswitch_blks_shift](#)” on page 411) and rebooting the system.

The next example sets the balanced I/O policy with a partition size of 2048 blocks (2MB) on the enclosure enc0:

```
# vxddmpadm setattr enclosure enc0 iopolicy=balanced \  
  partitionsize=2048
```

◆ `minimumq`

This policy sends I/O on paths that have the minimum number of outstanding I/O requests in the queue for a LUN. This is suitable for low-end disks or JBODs where a significant track cache does not exist. No further configuration is possible as DMP automatically determines the path with the shortest queue.

The following example sets the I/O policy to `minimumq` for a JBOD:

```
# vxddmpadm setattr enclosure Disk iopolicy=minimumq
```

◆ `priority`

This policy is useful when the paths in a SAN have unequal performance, and you want to enforce load balancing manually. You can assign priorities to each path based on your knowledge of the configuration and performance characteristics of the available paths, and of other aspects of your system. See “[Setting the Attributes of the Paths to an Enclosure](#)” on page 118 for details of how to assign priority values to individual paths.

In this example, the I/O policy is set to `priority` for all SENA arrays:

```
# vxddmpadm setattr arrayname SENA iopolicy=priority
```

◆ `round-robin`

This policy shares I/O equally between the paths in a round-robin sequence. For example, if there are three paths, the first I/O request would use one path, the second would use a different path, the third would be sent down the remaining path, the fourth would go down the first path, and so on. No further configuration is possible as this policy is automatically managed by DMP. This is the default policy for A/PC configurations with multiple active paths per controller.

The next example sets the I/O policy to `round-robin` for all Active/Active arrays:

```
# vxddmpadm setattr arraytype A/A iopolicy=round-robin
```

◆ `singleactive`

This policy routes I/O down one single active path. This is the default policy for A/P arrays with one active path per controller, where the other paths are used in case of failover. If configured for A/A arrays, there is no load balancing across the paths, and the alternate paths are only used to provide high availability (HA). If the currently active path fails, I/O is switched to an alternate active path. No further configuration is possible as the single active path is selected by DMP.

The following example sets the I/O policy to `singleactive` for JBOD disks:

```
# vxddmpadm setattr arrayname DISK iopolicy=singleactive
```

Example of Applying Load Balancing in a SAN

This example describes how to configure load balancing in a SAN environment where there are multiple primary paths to an Active/Passive device through several SAN switches. As can be seen in this sample output from the `vxddisk list` command, the device `c3t2d15` has eight primary paths:

```
# vxddisk list c3t2d15
Device: c3t2d15
...
numpaths: 8
c2t0d15 state=enabled type=primary
c2t1d15 state=enabled type=primary
c3t1d15 state=enabled type=primary
c3t2d15 state=enabled type=primary
c4t2d15 state=enabled type=primary
c4t3d15 state=enabled type=primary
c5t3d15 state=enabled type=primary
c5t4d15 state=enabled type=primary
```

In addition, the device is in the enclosure `ENC0`, belongs to the disk group `mydg`, and contains a simple concatenated volume `myvol1`.

The first step is to enable the gathering of DMP statistics:

```
# vxddmpadm iostat start
```

Next the `dd` command is used to apply an input workload from the volume:

```
# dd if=/dev/vx/rdisk/mydg/myvol1 of=/dev/null &
```



By running the `vxddmpadm iostat` command to display the DMP statistics for the device, it can be seen that all I/O is being directed to one path, `c5t4d15`:

```
# vxddmpadm iostat show dmpnodename=c3t2d15 interval=5 count=2
...
cpu usage = 11294us per cpu memory = 32768b
OPERATIONS          KBYTES          AVG TIME(ms)
PATHNAME  READS  WRITES  READS  WRITES  READS  WRITES
c2t0d15   0      0        0      0      0.000000 0.000000
c2t1d15   0      0        0      0      0.000000 0.000000
c3t1d15   0      0        0      0      0.000000 0.000000
c3t2d15   0      0        0      0      0.000000 0.000000
c4t2d15   0      0        0      0      0.000000 0.000000
c4t3d15   0      0        0      0      0.000000 0.000000
c5t3d15   0      0        0      0      0.000000 0.000000
c5t4d15 5493   0      5493   0      0.411069 0.000000
```

The `vxddmpadm` command is used to display the I/O policy for the enclosure that contains the device:

```
# vxddmpadm getattr enclosure ENC0 iopolicy
ENCLR_NAME      DEFAULT          CURRENT
=====
ENC0            Single-Active  Single-Active
```

This shows that the policy for the enclosure is set to `singleactive`, which explains why all the I/O is taking place on one path.

To balance the I/O load across the multiple primary paths, the policy is set to `round-robin` as shown here:

```
# vxddmpadm setattr enclosure ENC0 iopolicy=round-robin
# vxddmpadm getattr enclosure ENC0 iopolicy
ENCLR_NAME      DEFAULT          CURRENT
=====
ENC0            Single-Active  Round-Robin
```

The DMP statistics are now reset:

```
# vxddmpadm iostat reset
```

With the workload still running, the effect of changing the I/O policy to balance the load across the primary paths can now be seen.

```
# vxddmpadm iostat show dmpnodename=c3t2d15 interval=5 count=2
...
cpu usage = 14403us per cpu memory = 32768b
OPERATIONS          KBYTES          AVG TIME(ms)
PATHNAME  READS  WRITES  READS  WRITES  READS  WRITES
c2t0d15   1021    0      1021    0      0.396670 0.000000
c2t1d15    947    0       947    0      0.391763 0.000000
c3t1d15   1004    0      1004    0      0.393426 0.000000
c3t2d15   1027    0      1027    0      0.402142 0.000000
c4t2d15   1086    0      1086    0      0.390424 0.000000
c4t3d15   1048    0      1048    0      0.391221 0.000000
c5t3d15   1036    0      1036    0      0.390927 0.000000
c5t4d15   1021    0      1021    0      0.392752 0.000000
```

The enclosure can be returned to the single active I/O policy by entering the following command:

```
# vxddmpadm setattr enclosure ENC0 iopolicy=singleactive
```

Disabling a Controller

Note This operation is not supported for controllers that are used to access disk arrays on which cluster-shareable disk groups are configured.

Disabling I/O to a host disk controller prevents DMP from issuing I/O through the specified controller. The command blocks until all pending I/O issued through the specified disk controller are completed.

To disable a controller, use the following command:

```
# vxddmpadm [-f] disable ctrl=ctrl_name
```

The disable operation fails if it is issued to a controller connected to the root disk through a single path. If there is a single path connected to a disk, the disable command fails with an error message. Use the `-f` option to forcibly disable the controller.



Enabling a Controller

Note This operation is not supported for controllers that are used to access disk arrays on which cluster-shareable disk groups are configured.

Enabling a controller allows a previously disabled host disk controller to accept I/O. This operation succeeds only if the controller is accessible to the host and I/O can be performed on it. When connecting Active/Passive disk arrays in a non-clustered environment, the `enable` operation results in failback of I/O to the primary path. The `enable` operation can also be used to allow I/O to the controllers on a system board that was previously detached.

To enable a controller, use the following command:

```
# vxddmadmin enable ctrl=ctrl_name
```

Renaming an Enclosure

The `vxddmadmin setattr enclosure` command can be used to assign a meaningful name to an existing enclosure, for example:

```
# vxddmadmin setattr enclosure enc0 name=GRP1
```

This example changes the name of an enclosure from `enc0` to `GRP1`.

Note The maximum length of the enclosure name prefix is 25 characters. The name must not contain an underbar character (`_`).

The following command shows the changed name:

```
# vxddmadmin listenclosure all
```

ENCLR_NAME	ENCLR_TYPE	ENCLR_SNO	STATUS
other0	OTHER	OTHER_DISKS	CONNECTED
jbod0	X1	X1_DISKS	CONNECTED
GRP1	ACME	60020f20000001a90000	CONNECTED

Starting the DMP Restore Daemon

The DMP restore daemon re-examines the condition of paths at a specified interval. The type of analysis it performs on the paths depends on the specified checking policy.

Note The DMP restore daemon does not change the disabled state of the path through a controller that you have disabled using `vxddmpadm disable`.

Use the `start restore` command to start the restore daemon and specify one of the following policies:

◆ `check_all`

The restore daemon analyzes all paths in the system and revives the paths that are back online, as well as disabling the paths that are inaccessible. The command to start the restore daemon with this policy is:

```
# vxddmpadm start restore policy=check_all [interval=seconds]
```

◆ `check_alternate`

The restore daemon checks that at least one alternate path is healthy. It generates a notification if this condition is not met. This policy avoids inquiry commands on all healthy paths, and is less costly than `check_all` in cases where a large number of paths are available. This policy is the same as `check_all` if there are only two paths per DMP node. The command to start the restore daemon with this policy is:

```
# vxddmpadm start restore policy=check_alternate [interval=seconds]
```

◆ `check_disabled`

This is the default policy. The restore daemon checks the condition of paths that were previously disabled due to hardware failures, and revives them if they are back online. The command to start the restore daemon with this policy is:

```
# vxddmpadm start restore policy=check_disabled [interval=seconds]
```

◆ `check_periodic`

The restore daemon performs `check_all` once in a given number of cycles, and `check_disabled` in the remainder of the cycles. This policy may lead to periodic slowing down (due to `check_all`) if there are a large number of paths available. The command to start the restore daemon with this policy is:

```
# vxddmpadm start restore policy=check_periodic interval=seconds \  
[period=number]
```

The `interval` attribute must be specified for this policy. The default number of cycles between running the `check_all` policy is 10.



The interval attribute specifies how often the restore daemon examines the paths. For example, after stopping the restore daemon, the polling interval can be set to 400 seconds using the following command:

```
# vxdumpadm start restore interval=400
```

Note The default interval is 300 seconds. Decreasing this interval can adversely affect system performance.

To change the interval or policy, you must first stop the restore daemon, and then restart it with new attributes.

See the vxdumpadm(1M) manual page for more information about DMP restore policies.

Stopping the DMP Restore Daemon

Use the following command to stop the DMP restore daemon:

```
# vxdumpadm stop restore
```

Note Automatic path failback stops if the restore daemon is stopped.

Displaying the Status of the DMP Restore Daemon

Use the following command to display the status of the automatic path restoration daemon, its polling interval, and the policy that it uses to check the condition of paths:

```
# vxdumpadm stat restored
```

This produces output such as the following:

```
The number of daemons running : 1
The interval of daemon: 300
The policy of daemon: check_disabled
```

Displaying Information About the DMP Error Daemons

To display the number of error daemons that are running, use the following command:

```
# vxdumpadm stat error
```

Configuring Array Policy Modules

An array policy module (APM) is a dynamically loadable kernel module that may be provided by some vendors for use in conjunction with an array. An APM defines procedures to:

- ◆ Select an I/O path when multiple paths to a disk within the array are available.
- ◆ Select the path failover mechanism.
- ◆ Select the alternate path in the case of a path failure.
- ◆ Put a path change into effect.
- ◆ Respond to SCSI reservation or release requests.

DMP supplies default procedures for these functions when an array is registered. An APM may modify some or all of the existing procedures that are provided by DMP or by another version of the APM.

You can use the following command to display all the APMs that are configured for a system:

```
# vxdmadm listapm all
```

The output from this command includes the file name of each module, the supported array type, the APM name, the APM version, and whether the module is currently in use (*loaded*). To see detailed information for an individual module, specify the module name as the argument to the command:

```
# vxdmadm listapm module_name
```

To add and configure an APM, use the following command:

```
# vxdmadm -a cfgapm module_name [attr1=value1 [attr2=value2 ...]]
```

The optional configuration attributes and their values are specific to the APM for an array. Consult the documentation that is provided by the array vendor for details.

Note By default, DMP uses the most recent APM that is available. Specify the `-u` option instead of the `-a` option if you want to force DMP to use an earlier version of the APM. The current version of an APM is replaced only if it is not in use.

Specifying the `-r` option allows you to remove an APM that is not currently loaded:

```
# vxdmadm -r cfgapm module_name
```

For more information about configuring APMs, see the `vxdmadm(1M)` manual page.





Creating and Administering Disk Groups

4

This chapter describes how to create and manage *disk groups*. Disk groups are named collections of disks that share a common configuration. Volumes are created within a disk group and are restricted to using disks within that disk group.

Note In releases of VERITAS Volume Manager (VxVM) prior to 4.0, a system installed with VxVM was configured with a default disk group, `rootdg`, that had to contain at least one disk. By default, operations were directed to the `rootdg` disk group. From release 4.0 onward, VxVM can function without any disk group having been configured. Only when the first disk is placed under VxVM control must a disk group be configured. There is no longer a requirement that you name any disk group `rootdg`, and any disk group that is named `rootdg` has no special properties because of this name. See [“Specifying a Disk Group to Commands”](#) on page 132 for more information about using disk group names that are reserved for special purposes.

Additionally, prior to VxVM 4.0, some commands such as `vxdisk` were able to deduce the disk group if the name of an object was uniquely defined in one disk group among all the imported disk groups. Resolution of a disk group in this way is no longer supported for any command.

For a discussion of disk groups that are compatible with the Cross-platform Data Sharing (CDS) feature of VERITAS Volume Manager, see the *VERITAS Storage Foundation Cross-Platform Data Sharing Administrator’s Guide*. The CDS feature allows you to move VxVM disks and objects between machines that are running under different operating systems.

As system administrator, you can create additional disk groups to arrange your system’s disks for different purposes. Many systems do not use more than one disk group, unless they have a large number of disks. Disks can be initialized, reserved, and added to disk groups at any time. Disks need not be added to disk groups until the disks are needed to create VxVM objects.

When a disk is added to a disk group, it is given a name (for example, `mydg02`). This name identifies a disk for operations such as volume creation or mirroring. The name also relates directly to the underlying physical disk. If a physical disk is moved to a different



target address or to a different controller, the name `mydg02` continues to refer to it. Disks can be replaced by first associating a different physical disk with the name of the disk to be replaced and then recovering any volume data that was stored on the original disk (from mirrors or backup copies).

Having disk groups that contain many disks and VxVM objects causes the private region to fill. In the case of large disk groups that are expected to contain more than several hundred disks and VxVM objects, disks should be set up with larger private areas. A major portion of a private region provides space for a disk group configuration database that contains records for each VxVM object in that disk group. Because each configuration record takes up 256 bytes (or one quarter of a block), the number of records that can be created in a disk group can be estimated from the configuration database copy size. The copy size in blocks can be obtained from the output of the command `vx dg list diskgroup` as the value of the `permlen` parameter on the line starting with the string `"config:"`. This value is the smallest of the `len` values for all copies of the configuration database in the disk group. The amount of remaining free space in the configuration database is shown as the value of the `free` parameter. An example is shown in ["Displaying Disk Group Information"](#) on page 135. One way to overcome the problem of running out of free space is to split the affected disk group into two separate disk groups. See ["Reorganizing the Contents of Disk Groups"](#) on page 155 for details.

For information on backing up and restoring disk group configurations, see ["Backing Up and Restoring Disk Group Configuration Data"](#) on page 174.

Specifying a Disk Group to Commands

Note Most VxVM commands require superuser or equivalent privileges.

Many VxVM commands allow you to specify a disk group using the `-g` option. For example, the following command creates a volume in the disk group, `mkt dg`:

```
# vxassist -g mkt dg make mktvol 5g
```

The block special device corresponding to this volume is:

```
/dev/vx/dsk/mkt dg/mktvol
```

System-Wide Reserved Disk Groups

The following disk group names are reserved, and cannot be used to name any disk groups that you create:

`bootdg` Specifies the boot disk group. This is an alias for the disk group that contains the volumes that are used to boot the system. VxVM sets `bootdg` to the appropriate disk group if it takes control of the root disk. Otherwise, `bootdg` is set to `nodg` (no disk group; see below).

Caution Do not attempt to change the assigned value of `bootdg`. Doing so may render your system unbootable.

`defaultdg` Specifies the default disk group. This is an alias for the disk group name that should be assumed if the `-g` option is not specified to a command, or if the `VXVM_DEFAULTDG` environment variable is undefined. By default, `defaultdg` is set to `nodg` (no disk group; see below).

`nodg` Specifies to an operation that no disk group has been defined. For example, if the root disk is not under VxVM control, `bootdg` is set to `nodg`.

Note If you have upgraded your system, you may find it convenient to continue to configure a disk group named `rootdg` as the default disk group (`defaultdg`). There is no requirement that both `defaultdg` and `bootdg` refer to the same disk group, nor that either the default disk group or the boot disk group be named `rootdg`.

Rules for Determining the Default Disk Group

It is recommended that you use the `-g` option to specify a disk group to VxVM commands that accept this option. If you do not specify the disk group, VxVM applies the following rules in order until it determines a disk group name:

1. Use the default disk group name that is specified by the environment variable `VXVM_DEFAULTDG`. This variable can also be set to one of the reserved system-wide disk group names: `bootdg`, `defaultdg`, or `nodg`. If the variable is undefined, the following rule is applied.
2. Use the disk group that has been assigned to the system-wide default disk group alias, `defaultdg`. See [“Displaying and Specifying the System-Wide Default Disk Group”](#) on page 134. If this alias is undefined, the following rule is applied.
3. If the operation can be performed without requiring a disk group name (for example, an edit operation on disk access records), do so.



If none of these rules succeeds, the requested operation fails.

Caution In releases of VxVM prior to 4.0, a subset of commands attempted to deduce the disk group by searching for the object name that was being operated upon by a command. This functionality is no longer supported. Scripts that rely on deducing the disk group from an object name may fail.

Displaying the System-Wide Boot Disk Group

To display the currently defined system-wide boot disk group, use the following command:

```
# vxdbg bootdg
```

See the vxdbg(1M) manual page for more information.

Displaying and Specifying the System-Wide Default Disk Group

To display the currently defined system-wide default disk group, use the following command:

```
# vxdbg defaultdg
```

If a default disk group has not been defined, nodg is displayed. Alternatively, you can use the following command to display the default disk group:

```
# vxprint -Gng defaultdg 2>/dev/null
```

In this case, if there is no default disk group, nothing is displayed.

Use the following command to specify the name of the disk group that is aliased by defaultdg:

```
# vxdctl defaultdg diskgroup
```

If bootdg is specified as the argument to this command, the default disk group is set to be the same as the currently defined system-wide boot disk group.

If nodg is specified as the argument to the vxdctl defaultdg command, the default disk group is undefined.

Note The specified *diskgroup* need not currently exist on the system.

See the vxdctl(1M) and vxdbg(1M) manual pages for more information.

Displaying Disk Group Information

To display information on existing disk groups, enter the following command:

```
# vxdg list
NAME      STATE      ID
rootdg    enabled    730344554.1025.tweety
newdg     enabled    731118794.1213.tweety
```

To display more detailed information on a specific disk group, use the following command:

```
# vxdg list diskgroup
```

The output from this command is similar to the following:

```
Group: mydg
dgid: 962910960.1025.bass
import-id: 0.1
flags:
version: 110
local-activation: read-write
alignment : 512 (bytes)
ssb: on
detach-policy: local
copies: nconfig=default nlog=default
config: seqno=0.1183 permlen=3448 free=3428 templen=12 loglen=522
config disk c0t10d0 copy 1 len=3448 state=clean online
config disk c0t11d0 copy 1 len=3448 state=clean online
log disk c0t10d0 copy 1 len=522
log disk c0t11d0 copy 1 len=522
```

Note In this example, the administrator has chosen to name the boot disk group as `rootdg`.

To verify the disk group ID and name associated with a specific disk (for example, to import the disk group), use the following command:

```
# vxdisk -s list devicename
```



This command provides output that includes the following information for the specified disk. For example, output for disk `c0t12d0` as follows:

```
Disk: c0t12d0
type: simple
flags: online ready private autoconfig autoimport imported
diskid: 963504891.1070.bass
dgname: newdg
dgid: 963504895.1075.bass
hostid: bass
info: privoffset=128
```

Displaying Free Space in a Disk Group

Before you add volumes and file systems to your system, make sure you have enough free disk space to meet your needs.

To display free space in the system, use the following command:

```
# vxdbg free
```

The following is example output:

GROUP	DISK	DEVICE	TAG	OFFSET	LENGTH	FLAGS
mydg	mydg01	c0t10d0	c0t10d0	0	4444228	-
mydg	mydg02	c0t11d0	c0t11d0	0	4443310	-
newdg	newdg01	c0t12d0	c0t12d0	0	4443310	-
newdg	newdg02	c0t13d0	c0t13d0	0	4443310	-
oradg	oradg01	c0t14d0	c0t14d0	0	4443310	-

To display free space for a disk group, use the following command:

```
# vxdbg -g diskgroup free
```

where `-g diskgroup` optionally specifies a disk group.

For example, to display the free space in the disk group, `mydg`, use the following command:

```
# vxdbg -g mydg free
```

The following example output shows the amount of free space in sectors:

DISK	DEVICE	TAG	OFFSET	LENGTH	FLAGS
mydg01	c0t10d0	c0t10d0	0	4444228	-
mydg02	c0t11d0	c0t11d0	0	4443310	-

Creating a Disk Group

Data related to a particular set of applications or a particular group of users may need to be made accessible on another system. Examples of this are:

- ◆ A system has failed and its data needs to be moved to other systems.
- ◆ The work load must be balanced across a number of systems.

Disks must be placed in one or more disk groups before VxVM can use the disks for volumes. It is important that you locate data related to particular applications or users on an identifiable set of disks. When you need to move these disks, this allows you to move only the application or user data that should be moved.

A disk group must have at least one disk associated with it. A new disk group can be created when you use menu item 1 (Add or initialize one or more disks) of the `vxdiskadm` command to add disks to VxVM control, as described in [“Adding a Disk to VxVM”](#) on page 77. The disks to be added to a disk group must not belong to an existing disk group.

You can also use the `vxdiskadd` command to create a new disk group:

```
# vxdiskadd c1t0d0
```

where `c1t0d0` in this example is the device name of a disk that is not currently assigned to a disk group. The command dialog is similar to that described for the `vxdiskadm` command in [“Adding a Disk to VxVM”](#) on page 77.

Disk groups can also be created by using the `vx dg init` command:

```
# vx dg init diskgroup [cds=on|off] diskname=device name
```

For example, to create a disk group named `mktdg` on device `c1t0d0`:

```
# vx dg init mktdg mktdg01=c1t0d0
```

The disk specified by the device name, `c1t0d0`, must have been previously initialized with `vx diskadd` or `vx diskadm`, and must not currently belong to a disk group.

You can use the `cds` attribute with the `vx dg init` command to specify whether a new disk group is compatible with the Cross-platform Data Sharing (CDS) feature. In VERITAS Volume Manager 4.0 and later releases, newly created disk groups are compatible with CDS by default (equivalent to specifying `cds=on`). If you want to change this behavior, edit the file `/etc/default/vxdg`, and set the attribute-value pair `cds=off` in this file before creating a new disk group.

Alternatively, you can use the following command to set this attribute for a disk group:

```
# vx dg -g diskgroup set cds=on|off
```



Adding a Disk to a Disk Group

To add a disk to an existing disk group, use menu item 1 (Add or initialize one or more disks) of the `vxdiskadm` command. For details of this procedure, see [“Adding a Disk to VxVM”](#) on page 77.

You can also use the `vxdiskadd` command to add a disk to a disk group, for example:

```
# vxdiskadd c1t1d0
```

where `c1t1d0` is the device name of a disk that is not currently assigned to a disk group. The command dialog is similar to that described for the `vxdiskadm` command in [“Adding a Disk to VxVM”](#) on page 77.

Removing a Disk from a Disk Group

Note Before you can remove the last disk from a disk group, you must disable the disk group as described in [“Disabling a Disk Group”](#) on page 168. Alternatively, you can destroy the disk group as described in [“Destroying a Disk Group”](#) on page 168.

A disk that contains no subdisks can be removed from its disk group with this command:

```
# vxdg [-g diskgroup] rmdisk diskname
```

For example, to remove `mydg02` from the disk group, `mydg`, use this command:

```
# vxdg -g mydg rmdisk mydg02
```

If the disk has subdisks on it when you try to remove it, the following error message is displayed:

```
VxVM vxdg ERROR V-5-1-552 Disk diskname is used by one or more
subdisks
Use -k to remove device assignment.
```

Using the `-k` option allows you to remove the disk even if subdisks are present. For more information, see the `vxdg(1M)` manual page.

Caution Use of the `-k` option to `vxdg` can result in data loss.

Once the disk has been removed from its disk group, you can (optionally) remove it from VxVM control completely, as follows:

```
# vxdiskunsetup devicename
```

For example, to remove `c1t0d0` from VxVM control, use these commands:

```
# vxdiskunsetup c1t0d0
```

You can remove a disk on which some subdisks are defined. For example, you can consolidate all the volumes onto one disk. If you use `vxdiskadm` to remove a disk, you can choose to move volumes off that disk. To do this, run `vxdiskadm` and select item 2 (Remove a disk) from the main menu.

If the disk is used by some subdisks, this message is displayed:

```
VxVM ERROR V-5-2-369 The following volumes currently use part of disk
mydg02:
```

```
home usrvol
```

```
Subdisks must be moved from mydg02 before it can be removed.
```

```
Move subdisks to other disks? [y,n,q,?] (default: n)
```

If you choose **y**, then all subdisks are moved off the disk, if possible. Some subdisks may not be movable. The most common reasons why a subdisk may not be movable are as follows:

- ◆ There is not enough space on the remaining disks.
- ◆ Plexes or striped subdisks cannot be allocated on different disks from existing plexes or striped subdisks in the volume.

If `vxdiskadm` cannot move some subdisks, you may need to remove some plexes from some disks to free more space before proceeding with the disk removal operation.

Deporting a Disk Group

Deporting a disk group disables access to a disk group that is currently enabled (imported) by the system. Deport a disk group if you intend to move the disks in a disk group to another system. Also, deport a disk group if you want to use all of the disks remaining in a disk group for a new purpose.

To deport a disk group, use the following procedure:

1. Stop all activity by applications to volumes that are configured in the disk group that is to be deported. Unmount file systems and shut down databases that are configured on the volumes.

Note Deportation fails if the disk group contains volumes that are in use (for example, by mounted file systems or databases).

2. Use the following command to stop the volumes in the disk group:

```
# vxvol -g diskgroup stopall
```



3. Select menu item 8 (Remove access to (deport) a disk group) from the `vxdiskadm` main menu.
4. At the following prompt, enter the name of the disk group to be deported (in this example, `newdg`):

```
Remove access to (deport) a disk group
Menu: VolumeManager/Disk/DeportDiskGroup
```

Use this menu operation to remove access to a disk group that is currently enabled (imported) by this system. Deport a disk group if you intend to move the disks in a disk group to another system. Also, deport a disk group if you want to use all of the disks remaining in a disk group for some new purpose.

You will be prompted for the name of a disk group. You will also be asked if the disks should be disabled (offlined). For removable disk devices on some systems, it is important to disable all access to the disk before removing the disk. Enter name of disk group [`<group>,list,q,?`] (default: `list`)
newdg

5. At the following prompt, enter `y` if you intend to remove the disks in this disk group:

```
VxVM INFO V-5-2-377 The requested operation is to disable access
to the removable disk group named newdg. This disk group is
stored on the following disks:
    newdg01 on device clt1d0
```

You can choose to disable access to (also known as "offline") these disks. This may be necessary to prevent errors if you actually remove any of the disks from the system.

```
Disable (offline) the indicated disks? [y,n,q,?] (default: n) y
```

6. At the following prompt, press Return to continue with the operation:

```
Continue with operation? [y,n,q,?] (default: y)
```

Once the disk group is deported, the `vxdiskadm` utility displays the following message:

```
VxVM INFO V-5-2-269 Removal of disk group newdg was successful.
```



- At the following prompt, indicate whether you want to disable another disk group (y) or return to the `vxdiskadm` main menu (n):

```
Disable another disk group? [y,n,q,?] (default: n)
```

Alternatively, you can use the `vxdbg` command to deport a disk group:

```
# vxdbg deport diskgroup
```

Importing a Disk Group

Importing a disk group enables access by the system to a disk group. To move a disk group from one system to another, first disable (deport) the disk group on the original system, and then move the disk between systems and enable (import) the disk group.

To import a disk group, use the following procedure:

- Use the following command to ensure that the disks in the deported disk group are online:

```
# vxdisk -s list
```

- Select menu item 7 (Enable access to (import) a disk group) from the `vxdiskadm` main menu.
- At the following prompt, enter the name of the disk group to import (in this example, `newdrg`):

```
Enable access to (import) a disk group
Menu: VolumeManager/Disk/EnableDiskGroup
```

Use this operation to enable access to a disk group. This can be used as the final part of moving a disk group from one system to another. The first part of moving a disk group is to use the "Remove access to (deport) a disk group" operation on the original host.

A disk group can be imported from another host that failed without first deporting the disk group. Be sure that all disks in the disk group are moved between hosts.

If two hosts share a SCSI bus, be very careful to ensure that the other host really has failed or has deported the disk group. If two active hosts import a disk group at the same time, the disk group will be corrupted and will become unusable.

```
Select disk group to import [<group>,list,q,?] (default: list)
newdrg
```



Once the import is complete, the `vxdiskadm` utility displays the following success message:

```
VxVM INFO V-5-2-374 The import of newdg was successful.
```

4. At the following prompt, indicate whether you want to import another disk group (`y`) or return to the `vxdiskadm` main menu (`n`):

```
Select another disk group? [y,n,q,?] (default: n)
```

Alternatively, you can use the `vx dg` command to import a disk group:

```
# vx dg import diskgroup
```

Renaming a Disk Group

Only one disk group of a given name can exist per system. It is not possible to import or deport a disk group when the target system already has a disk group of the same name. To avoid this problem, VxVM allows you to rename a disk group during import or deport.

To rename a disk group during import, use the following command:

```
# vx dg [-t] -n newdg import diskgroup
```

If the `-t` option is included, the import is temporary and does not persist across reboots. In this case, the stored name of the disk group remains unchanged on its original host, but the disk group is known by the name specified by `newdg` to the importing host. If the `-t` option is not used, the name change is permanent.

For example, this command temporarily renames the disk group, `mydg`, as `mytempdg` on import:

```
# vx dg -t -n mytempdg import mydg
```

To rename a disk group during deport, use the following command:

```
# vx dg [-h hostname] -n newdg deport diskgroup
```

When renaming on deport, you can specify the `-h hostname` option to assign a lock to an alternate host. This ensures that the disk group is automatically imported when the alternate host reboots.

For example, this command renames the disk group, `mydg`, as `myexdg`, and deports it to the host, `jingo`:

```
# vx dg -h jingo -n myexdg deport mydg
```

Note You cannot use this method to rename the active boot disk group because it contains volumes that are in use by mounted file systems (such as `/`). To rename the boot disk group, boot the system from an LVM root disk instead of from the VxVM root disk. You can then use the above methods to rename the boot disk group. See the sections under “[Rootability](#)” on page 82 for more information.

To temporarily move the boot disk group, `bootdg`, from one host to another (for repair work on the root volume, for example) and then move it back, use the following procedure.

Note This procedure assumes that all the disks in the boot disk group are accessible by both hosts.

1. On the original host, identify the disk group ID of the `bootdg` disk group to be imported with the following command:

```
# vxdisk -g bootdg -s list
```

This command results in output such as the following:

```
dgname: rootdg
dgid:    774226267.1025.tweety
```

Note In this example, the administrator has chosen to name the boot disk group as `rootdg`. The ID of this disk group is `774226267.1025.tweety`.

2. Shut down the original host.
3. On the importing host, import and rename the `rootdg` disk group with this command:

```
# vxdg -tC -n newdg import diskgroup
```

The `-t` option indicates a temporary import name, and the `-C` option clears import locks. The `-n` option specifies an alternate name for the `rootdg` being imported so that it does not conflict with the existing `rootdg`. `diskgroup` is the disk group ID of the disk group being imported (for example, `774226267.1025.tweety`).

If a reboot or crash occurs at this point, the temporarily imported disk group becomes unimported and requires a reimport.

4. After the necessary work has been done on the imported disk group, deport it back to its original host with this command:

```
# vxdg -h hostname deport diskgroup
```



Here *hostname* is the name of the system whose `rootdg` is being returned (the system name can be confirmed with the command `uname -n`).

This command removes the imported disk group from the importing host and returns locks to its original host. The original host can then automatically import its boot disk group at the next reboot.

Moving Disks Between Disk Groups

To move a disk between disk groups, remove the disk from one disk group and add it to the other. For example, to move the physical disk `c0t3d0` (attached with the disk name `salesdg04`) from disk group `salesdg` and add it to disk group `mkt dg`, use the following commands:

```
# vxdbg -g salesdg rmdisk salesdg04
# vxdbg -g mkt dg adddisk mkt dg02=c0t3d0
```

Caution This procedure does not save the configurations nor data on the disks.

You can also move a disk by using the `vxdiskadm` command. Select item 3 (Remove a disk) from the main menu, and then select item 1 (Add or initialize a disk).

See “[Moving Objects Between Disk Groups](#)” on page 163 for an alternative and preferred method of moving disks between disk groups. This method preserves VxVM objects, such as volumes, that are configured on the disks.

Moving Disk Groups Between Systems

An important feature of disk groups is that they can be moved between systems. If all disks in a disk group are moved from one system to another, then the disk group can be used by the second system. You do not have to re-specify the configuration.

To move a disk group between systems, use the following procedure:

1. On the first system, stop all volumes in the disk group, then deport (disable local access to) the disk group with the following command:

```
# vxdbg deport diskgroup
```

2. Move all the disks to the second system and perform the steps necessary (system-dependent) for the second system and VxVM to recognize the new disks.

This can require a reboot, in which case the `vxconfigd` daemon is restarted and recognizes the new disks. If you do not reboot, use the command `vxctl enable` to restart the `vxconfigd` program so VxVM also recognizes the disks.

3. Import (enable local access to) the disk group on the second system with this command:

```
# vxdg import diskgroup
```

Caution All disks in the disk group must be moved to the other system. If they are not moved, the import fails.

4. After the disk group is imported, start all volumes in the disk group with this command:

```
# vxrecover -g diskgroup -sb
```

You can also move disks from a system that has crashed. In this case, you cannot deport the disk group from the first system. When a disk group is created or imported on a system, that system writes a lock on all disks in the disk group.

Caution The purpose of the lock is to ensure that *dual-ported disks* (disks that can be accessed simultaneously by two systems) are not used by both systems at the same time. If two systems try to access the same disks at the same time, this must be managed using software such as the clustering functionality of VxVM. Otherwise, configuration information stored on the disk may be corrupted, and the data on the disk may become unusable.

Handling Errors when Importing Disks

When you move disks from a system that has crashed or that failed to detect the group before the disk was moved, the locks stored on the disks remain and must be cleared. The system returns the following error message:

```
VxVM vxdg ERROR V-5-1-587 disk group groupname: import failed:
Disk is in use by another host
```

The next message indicates that the disk group does not contain any valid disks (not that it does not contain any disks):

```
VxVM vxdg ERROR V-5-1-587 Disk group groupname: import failed:
No valid disk found containing disk group
```

The disks may be considered invalid due to a mismatch between the host ID in their configuration copies and that stored in the `/etc/vx/volboot` file.

To clear locks on a specific set of devices, use the following command:

```
# vxdisk clearimport devicename ...
```

To clear the locks during import, use the following command:

```
# vxdg -C import diskgroup
```



Caution Be careful when using the `vxdisk clearimport` or `vx dg -C import` command on systems that have dual-ported disks. Clearing the locks allows those disks to be accessed at the same time from multiple hosts and can result in corrupted data.

You may want to import a disk group when some disks are not available. The `import` operation fails if some disks for the disk group cannot be found among the disk drives attached to the system. When the `import` operation fails, one of several error messages is displayed.

The following message indicates a fatal error that requires hardware repair or the creation of a new disk group, and recovery of the disk group configuration and data:

```
VxVM vx dg ERROR V-5-1-587 Disk group groupname: import failed:  
Disk group has no valid configuration copies
```

The following message indicates a recoverable error.

```
VxVM vx dg ERROR V-5-1-587 Disk group groupname: import failed:  
Disk for disk group not found
```

If some of the disks in the disk group have failed, force the disk group to be imported with the command:

```
# vx dg -f import diskgroup
```

Caution Be careful when using the `-f` option. It can cause the same disk group to be imported twice from different sets of disks, causing the disk group to become inconsistent.

These operations can also be performed using the `vx diskadm` utility. To deport a disk group using `vx diskadm`, select menu item 8 (Remove access to (deport) a disk group). To import a disk group, select item 7 (Enable access to (import) a disk group). The `vx diskadm import` operation checks for host import locks and prompts to see if you want to clear any that are found. It also starts volumes in the disk group.

Reserving Minor Numbers for Disk Groups

A *device minor number* uniquely identifies some characteristic of a device to the device driver that controls that device. It is often used to identify some characteristic mode of an individual device, or to identify separate devices that are all under the control of a single controller. VxVM assigns unique device minor numbers to each object (volume, plex, subdisk, disk, or disk group) that it controls.

When you move a disk group between systems, it is possible for the minor numbers that it used on its previous system to coincide (or *collide*) with those of objects known to VxVM on the new system. To get around this potential problem, you can allocate separate ranges of minor numbers for each disk group. VxVM uses the specified range of minor numbers when it creates volume objects from the disks in the disk group. This guarantees that each volume has the same minor number across reboots or reconfigurations. Disk groups may then be moved between machines without causing device number collisions.

VxVM chooses minor device numbers for objects created from this disk group starting at the base minor number *base_minor*. Minor numbers can range from this value up to 16,777,215. Try to leave a reasonable number of unallocated minor numbers near the top of this range to allow for temporary device number remapping in the event that a device minor number collision may still occur.

VxVM reserves the range of minor numbers from 0 to 999 for use with volumes in the boot disk group. For example, the `rootvol` volume is always assigned minor number 0.

If you do not specify the base of the minor number range for a disk group, VxVM chooses one at random. The number chosen is at least 1000, is a multiple of 1000, and yields a usable range of 1000 device numbers. The chosen number also does not overlap within a range of 1000 of any currently imported disk groups, and it does not overlap any currently allocated volume device numbers.

Note The default policy ensures that a small number of disk groups can be merged successfully between a set of machines. However, where disk groups are merged automatically using failover mechanisms, select ranges that avoid overlap.

To view the base minor number for an existing disk group, use the `vxprint` command as shown in the following examples for the disk group, `mydg`:

```
# vxprint -l mydg | egrep minors
minors: >=45000
# vxprint -g mydg -m | egrep base_minor
base_minor=45000
```

To set a base volume device minor number for a disk group that is being created, use the following command:

```
# vxdg init diskgroup minor=base_minor disk_access_name ...
```



For example, the following command creates the disk group, `newdg`, that includes the specified disks, and has a base minor number of 30000:

```
# xvdbg init newdg minor=30000 c1d0t0 c1t1d0
```

If a disk group already exists, you can use the `vxdbg reminor` command to change its base minor number:

```
# vxdbg -g diskgroup reminor new_base_minor
```

For example, the following command changes the base minor number to 30000 for the disk group, `mydg`:

```
# vxprint -g mydg reminor 30000
```

If a volume is open, its old device number remains in effect until the system is rebooted or until the disk group is deported and re-imported. If you close the open volume, you can run `vxdbg reminor` again to allow the renumbering to take effect without rebooting or re-importing.

An example of where it is necessary to change the base minor number is for a cluster-shareable disk group. The volumes in a shared disk group must have the same minor number on all the nodes. If there is a conflict between the minor numbers when a node attempts to join the cluster, the join fails. You can use the `reminor` operation on the nodes that are in the cluster to resolve the conflict. In a cluster where more than one node is joined, use a base minor number which does not conflict on any node.

For further information on minor number reservation, see the `vxdbg(1M)` manual page.

Compatibility of Disk Groups Between Platforms

For disk groups that support the Cross-platform Data Sharing (CDS) feature, the upper limit on the minor number range is restricted on AIX, HP-UX, Linux (with a 2.6 or later kernel) and Solaris to 65,535 to ensure portability between these operating systems.

On a Linux platform with a pre-2.6 kernel, the number of minor numbers per major number is limited to 256 with a base of 0. This has the effect of limiting the number of volumes and disks that can be supported system-wide to a smaller value than is allowed on other operating system platforms. The number of disks that are supported by a pre-2.6 Linux kernel is typically limited to a few hundred. With the extended major numbering scheme that was implemented in VxVM 4.0 on Linux, a maximum of 4079 volumes could be configured, provided that a contiguous block of 15 extended major numbers was available.

VxVM 4.1 runs on a 2.6 version Linux kernel, which increases the number of minor devices that are configurable from 256 to 65,536 per major device number. This allows a large number of volumes and disk devices to be configured on a system. The theoretical

limit on the number of DMP and volume devices that can be configured on such a system are 65,536 and 1,048,576 respectively. However, in practice, the number of VxVM devices that can be configured in a single disk group is limited by the size of the private region.

When a CDS-compatible disk group is imported on a Linux system with a pre-2.6 kernel, VxVM attempts to reassign the minor numbers of the volumes, and fails if this is not possible.

To help ensure that a CDS-compatible disk group is portable between operating systems, including Linux with a pre-2.6 kernel, use the following command to set the `maxdev` attribute on the disk group:

```
# vxdg -g diskgroup set maxdev=4079
```

Note Such a disk group may still not be importable by VxVM 4.0 on Linux with a pre-2.6 kernel if it would increase the number of minor numbers on the system that are assigned to volumes to more than 4079, or if the number of available extended major numbers is smaller than 15.

You can use the following command to discover the maximum number of volumes that are supported by VxVM on a Linux host:

```
# cat /proc/sys/vxvm/vxio/vol_max_volumes
4079
```

See the `vxdg(1M)` manual page for more information.



Handling Conflicting Configuration Copies in a Disk Group

If an incomplete disk group is imported on several different systems, this can create inconsistencies in the disk group configuration copies that you may need to resolve manually. This section and following sections describe how such a condition can occur, and how to correct it. (When the condition occurs in a cluster that has been split, it is usually referred to as a *serial split brain* condition).

Note The procedures given here require that the version number of the disk group is at least 110. However, these procedures cannot be applied to SAN disk groups.

Example of a Serial Split Brain Condition in a Campus Cluster

Note This section presents an example of how a serial split brain condition might occur for a shared disk group in a cluster. For more information about shared disk groups in clusters, see “[Administering Cluster Functionality](#)” on page 347. Conflicts between configuration copies can also occur for private disk groups in clustered and non-clustered configurations where the disk groups have been partially imported on different systems. The procedure in “[Correcting Conflicting Configuration Information](#)” on page 154 describes how to correct such problems.

A campus cluster (also known as a *stretch cluster*) typically consists of a 2-node cluster where each component (server, switch and storage) of the cluster exists in a separate building. This is illustrated in “[Typical Arrangement of a 2-node Campus Cluster](#),” which shows a 2-node cluster with node 0, a fibre channel switch and disk enclosure `enc0` in building A, and node 1, another switch and enclosure `enc1` in building B. The fibre channel connectivity is multiply redundant to implement redundant-loop access between each node and each enclosure. As usual, the two nodes are also linked by a redundant private network.

Typical Arrangement of a 2-node Campus Cluster

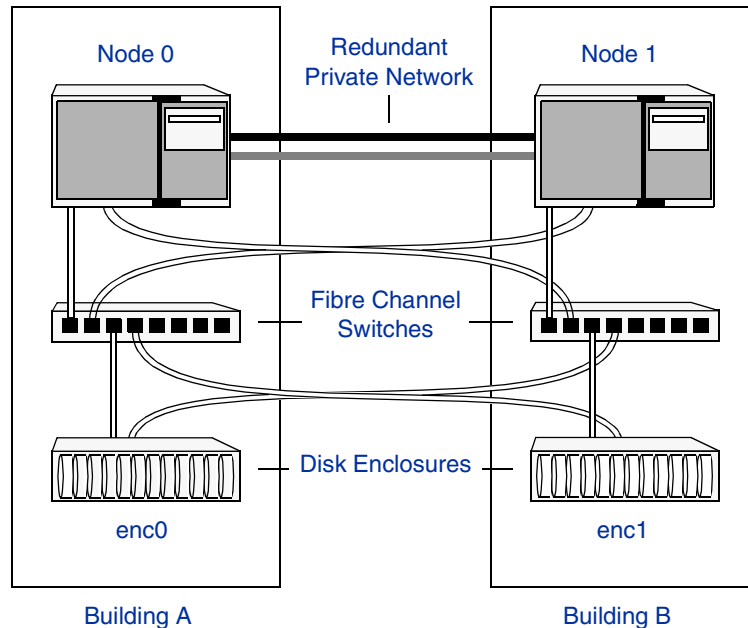

A serial split brain condition typically arises in a cluster when a private (non-shared) disk group is imported on Node 0 with Node 1 configured as the failover node.

If the network connections between the nodes are severed, both nodes think that the other node has died. (This is the usual cause of the split brain condition in clusters). If a disk group is spread across both enclosure `enc0` and `enc1`, each portion loses connectivity to the other portion of the disk group. Node 0 continues to update to the disks in the portion of the disk group that it can access. Node 1, operating as the failover node, imports the other portion of the disk group (with the `-f` option set), and starts updating the disks that it can see.

When the network links are restored, attempting to reattach the missing disks to the disk group on Node 0, or to re-import the entire disk group on either node, fails. This serial split brain condition arises because VxVM increments the serial ID in the disk media record of each imported disk in all the disk group configuration databases on those disks, and also in the private region of each imported disk. The value that is stored in the configuration database represents the serial ID that the disk group expects a disk to have. The serial ID that is stored in a disk's private region is considered to be its actual value.

If some disks went missing from the disk group (due to physical disconnection or power failure) and those disks were imported by another host, the serial IDs for the disks in their copies of the configuration database, and also in each disk's private region, are updated



separately on that host. When the disks are subsequently re-imported into the original shared disk group, the actual serial IDs on the disks do not agree with the expected values from the configuration copies on other disks in the disk group.

Depending on what happened to the different portions of the split disk group, there are two possibilities for resolving inconsistencies between the configuration databases:

- ◆ If the other disks in the disk group were not imported on another host, VxVM resolves the conflicting values of the serial IDs by using the version of the configuration database from the disk with the greatest value for the updated ID (shown as `update_tid` in the output from the `vxkg list diskgroup` command). This case is illustrated below.

Example of a Serial Split Brain Condition that Can Be Resolved Automatically

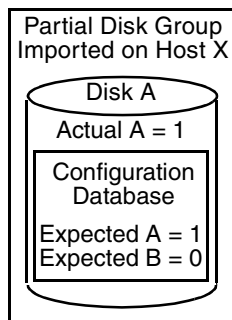

Disk B Not Imported

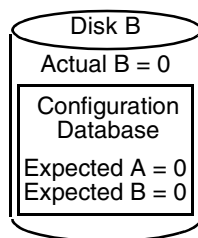

1. Disk A is imported on a separate host. Disk B is not imported. The actual and expected serial IDs are updated only on disk A.

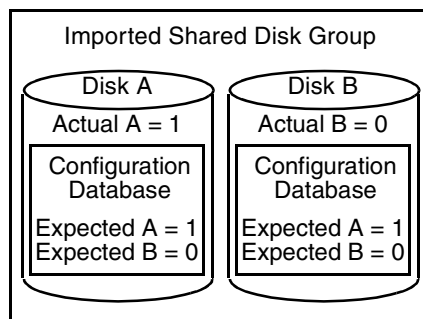

2. The disk group is re-imported on the cluster. The configuration copy on disk A is used to correct the configuration copy on disk B as the actual value of the updated ID on disk A is greatest.

- ◆ If the other disks were also imported on another host, no disk can be considered to have a definitive copy of the configuration database. The figure below illustrates how this condition can arise for two disks.

Example of a True Serial Split Brain Condition that Cannot Be Resolved Automatically

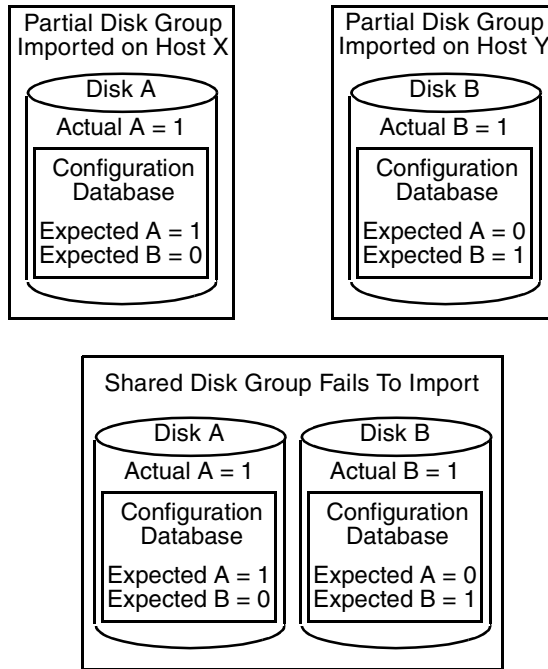

1. Disks A and B are imported independently on separate hosts. The actual and expected serial IDs are updated independently on each disk.

2. The disk group cannot be reimported on the cluster. This is because the databases do not agree on the actual and expected serial IDs. You must choose which configuration database to use.

This is a true serial split brain condition, which VxVM cannot correct automatically. In this case, the disk group import fails, and the `vx dg` utility outputs error messages similar to the following before exiting:

```
VxVM vxconfigd NOTICE V-5-0-33 Split Brain. da id is 0.1, while dm
id is 0.0 for DM mydg01
VxVM vx dg ERROR V-5-1-587 Disk group newdg: import failed: Serial
Split Brain detected. Run vxsplitlines
```

The import does not succeed even if you specify the `-f` flag to `vx dg`.

Although it is usually possible to resolve this conflict by choosing the version of the configuration database with the highest valued configuration ID (shown as `config_tid` in the output from the `vx dg list diskgroup` command), this may not be the correct thing to do in all circumstances.

The following section, "[Correcting Conflicting Configuration Information](#)," describes how to fix this condition.



Correcting Conflicting Configuration Information

Note This procedure requires that the disk group has a version number of at least 110. See [“Upgrading a Disk Group”](#) on page 169 for more information about disk group version numbers.

To resolve conflicting configuration information, you must decide which disk contains the correct version of the disk group configuration database. To assist you in doing this, you can run the `vxsplitlines` command to show the actual serial ID on each disk in the disk group and the serial ID that was expected from the configuration database. For each disk, the command also shows the `vx dg` command that you must run to select the configuration database copy on that disk as being the definitive copy to use for importing the disk group.

The following is sample output from running `vxsplitlines` on the disk group `newdg`:

```
# vxsplitlines -g newdg
The following splits were found in diskgroup newdg
They are listed in da(dm) name pairs.

Pool 0.
  c2t5d0 ( c2t5d0 ), c2t6d0 ( c2t6d0 ),
The configuration from any of the disks in this split should appear
to be be the same.
To see the configuration from any of the disks in this split, run:
  /etc/vx/diag.d/vxprivutil dumpconfig /dev/vx/dmp/c2t5d0
To import the dg with the configuration from this split, run:
  /usr/sbin/vxdg -o selectcp=1045852127.32.olancha import newdg
To get more information about this particular configuration, run:
  /usr/sbin/vxsplitlines -g newdg -c c2t5d0

Split 1.
  c2t7d0 ( c2t7d0 ), c2t8d0 ( c2t8d0 ),
The configuration from any of the disks in this split should appear
to be be the same.
To see the configuration from any of the disks in this split, run:
  /etc/vx/diag.d/vxprivutil dumpconfig /dev/vx/dmp/c2t7d0
To import the dg with the configuration from this split, run:
  /usr/sbin/vxdg -o selectcp=1045852127.33.olancha import newdg
To get more information about this particular configuration, run:
  /usr/sbin/vxsplitlines -g newdg -c c2t7d0
```

In this example, the disk group has four disks, and is split so that two disks appear to be on each side of the split.

You can specify the `-c` option to `vxsplitlines` to print detailed information about each of the disk IDs from the configuration copy on a disk specified by its disk access name:

```
# vxsplitlines -g newdg -c c2t6d0
DANAME (DMNAME)      || Actual SSB || Expected SSB
c2t5d0( c2t5d0 )    || 0.1          || 0.0 ssb ids don't match
c2t6d0( c2t6d0 )    || 0.1          || 0.1 ssb ids match
c2t7d0( c2t7d0 )    || 0.1          || 0.1 ssb ids match
c2t8d0( c2t8d0 )    || 0.1          || 0.0 ssb ids don't match
```

Please note that even though some disks ssb ids might match that does not necessarily mean that those disks' config copies have all the changes. From some other configuration copies, those disks' ssb ids might not match.

To see the configuration from this disk, run
`/etc/vx/diag.d/vxprivutil dumpconfig /dev/vx/dmp/c2t6d0`

Based on your knowledge of how the serial split brain condition came about, you must choose one disk's configuration to be used to import the disk group. For example, the following command imports the disk group using the configuration copy that is on side 0 of the split:

```
# /usr/sbin/vxdg -o selectcp=1045852127.32.olancha import newdg
```

When you have selected a preferred configuration copy, and the disk group has been imported, VxVM resets the serial IDs to 0 for the imported disks. The actual and expected serial IDs for any disks in the disk group that are not imported at this time remain unaltered.

Reorganizing the Contents of Disk Groups

Note You need a VERITAS FlashSnap™ license to use this feature.

There are several circumstances under which you might want to reorganize the contents of your existing disk groups:

- ◆ To group volumes or disks differently as the needs of your organization change. For example, you might want to split disk groups to match the boundaries of separate departments, or to join disk groups when departments are merged.
- ◆ To reduce the size of a disk group's configuration database in the event that its private region is nearly full. This is a much simpler solution than the alternative of trying to grow the private region.
- ◆ To perform online maintenance and upgrading of fault-tolerant systems that can be split into separate hosts for this purpose, and then rejoined.



- ◆ To isolate volumes or disks from a disk group, and process them independently on the same host or on a different host. This allows you to implement off-host processing solutions for the purposes of backup or decision support. This is discussed further in “[Configuring Off-Host Processing](#)” on page 315.

You can use either the VERITAS Enterprise Administrator (VEA) or the `vxpdg` command to reorganize your disk groups. For more information about using the graphical user interface, see the *VERITAS Enterprise Administrator Getting Started* manual and VEA online help. This section describes how to use the `vxpdg` command.

The `vxpdg` command provides the following operations for reorganizing disk groups:

- ◆ `move`—moves a self-contained set of VxVM objects between imported disk groups. This operation fails if it would remove all the disks from the source disk group. Volume states are preserved across the move. The `move` operation is illustrated in “[Disk Group Move Operation](#)” on page 156.

Disk Group Move Operation

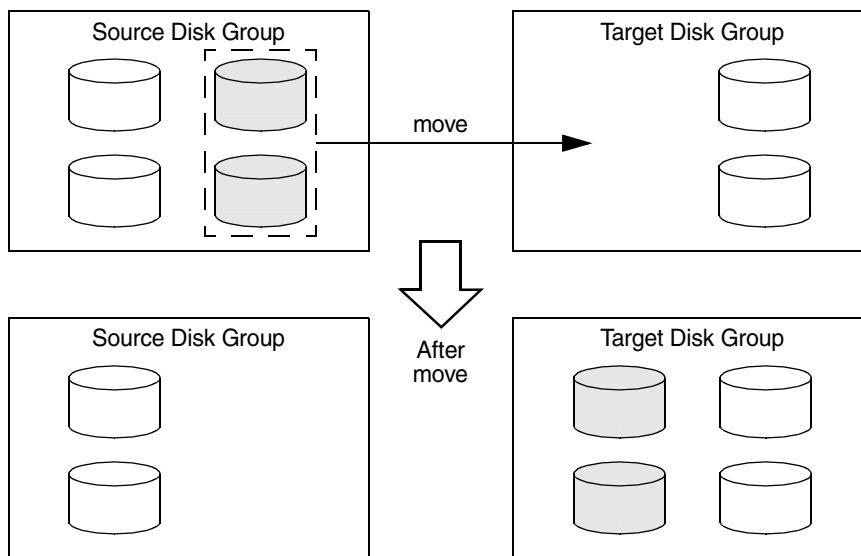

- ◆ `split`—removes a self-contained set of VxVM objects from an imported disk group, and moves them to a newly created target disk group. This operation fails if it would remove all the disks from the source disk group, or if an imported disk group exists with the same name as the target disk group. An existing deported disk group is destroyed if it has the same name as the target disk group (as is the case for the `vxpdg init` command). The `split` operation is illustrated in “[Disk Group Split Operation](#)” on page 157.

Disk Group Split Operation

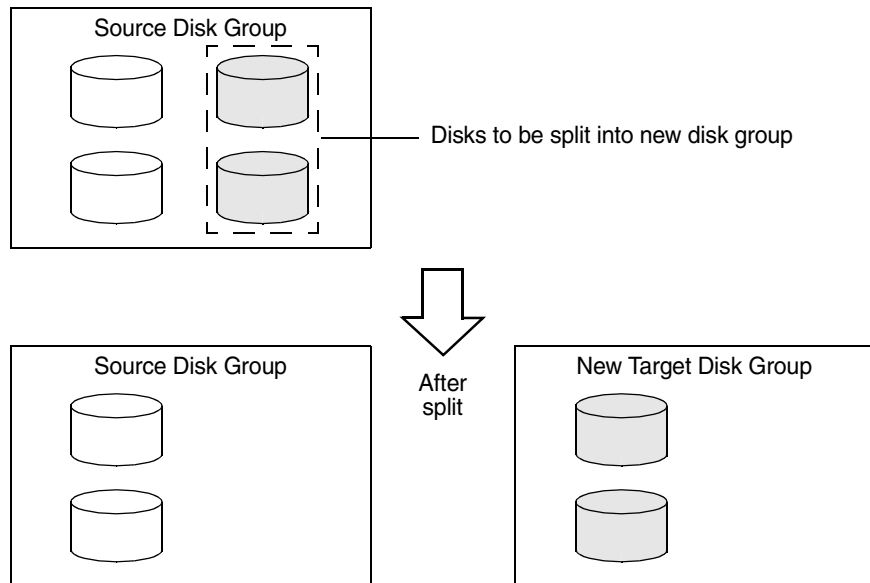

- ◆ `join`—removes all VxVM objects from an imported disk group and moves them to an imported target disk group. The source disk group is removed when the join is complete. The `join` operation is illustrated in “Disk Group Join Operation” on page 158.

Disk Group Join Operation

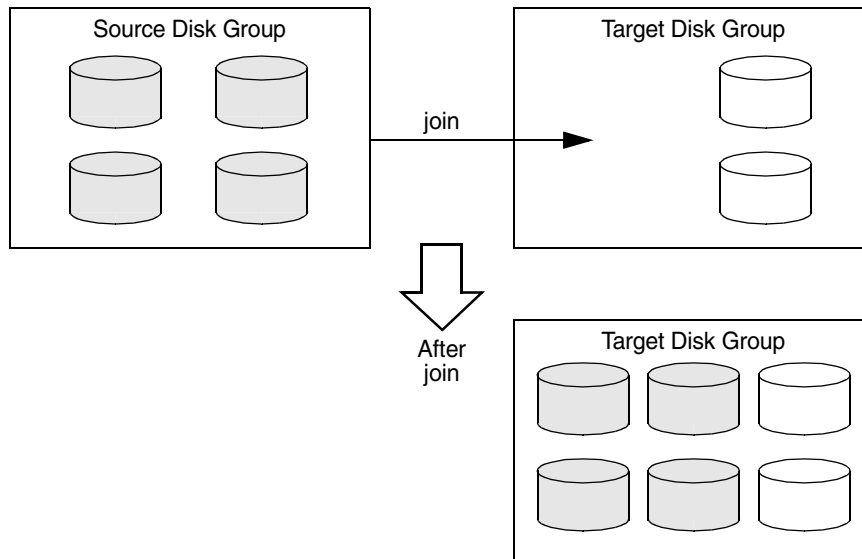

These operations are performed on VxVM objects such as disks or top-level volumes, and include all component objects such as sub-volumes, plexes and subdisks. The objects to be moved must be *self-contained*, meaning that the disks that are moved must not contain any other objects that are not intended for the move.

If you specify one or more disks to be moved, all VxVM objects on the disks are moved. You can use the `-o expand` option to ensure that `vxchg` moves all disks on which the specified objects are configured. Take care when doing this as the result may not always be what you expect. You can use the `listmove` operation with `vxchg` to help you establish what is the self-contained set of objects that corresponds to a specified set of objects.

Caution Before moving volumes between disk groups, stop all applications that are accessing the volumes, and unmount all file systems that are configured on these volumes.

If the system crashes or a hardware subsystem fails, VxVM attempts to complete or reverse an incomplete disk group reconfiguration when the system is restarted or the hardware subsystem is repaired, depending on how far the reconfiguration had progressed. If one of the disk groups is no longer available because it has been imported by another host or because it no longer exists, you must recover the disk group manually as described in the section “Recovery from Incomplete Disk Group Moves” in the chapter “Recovery from Hardware Failure” of the *VERITAS Volume Manager Troubleshooting Guide*.

Limitations of Disk Group Split and Join

The disk group split and join feature has the following limitations:

- ◆ Disk groups involved in a move, split or join must be version 90 or greater. See “[Upgrading a Disk Group](#)” on page 169 for more information on disk group versions.
- ◆ The reconfiguration must involve an integral number of physical disks.
- ◆ Objects to be moved must not contain open volumes.
- ◆ Disks cannot be moved between CDS and non-CDS compatible disk groups.
- ◆ Moved volumes are initially disabled following a disk group move, split or join. Use the `vxrecover -m` and `vxvol startall` commands to recover and restart the volumes.
- ◆ Data change objects (DCOs) and snap objects that have been dissociated by Persistent FastResync cannot be moved between disk groups.
- ◆ VERITAS Volume Replicator (VVR) objects cannot be moved between disk groups.
- ◆ For a disk group move to succeed, the source disk group must contain at least one disk that can store copies of the configuration database after the move.
- ◆ For a disk group split to succeed, both the source and target disk groups must contain at least one disk that can store copies of the configuration database after the split.
- ◆ For a disk group move or join to succeed, the configuration database in the target disk group must be able to accommodate information about all the objects in the enlarged disk group.
- ◆ Splitting or moving a volume into a different disk group changes the volume’s record ID.
- ◆ The operation can only be performed on the master node of a cluster if either the source disk group or the target disk group is shared.
- ◆ In a cluster environment, disk groups involved in a move or join must both be private or must both be shared.



- ◆ When used with objects that have been created using the VERITAS Intelligent Storage Provisioning (ISP) feature, only complete storage pools may be split or moved from a disk group. Individual objects such as application volumes within storage pools may not be split or moved. See the *VERITAS Storage Foundation Intelligent Storage Provisioning Administrator's Guide* for a description of ISP and storage pools.
- ◆ If a cache object or volume set that is to be split or moved uses ISP volumes, the storage pool that contains these volumes must also be specified.

The following sections describe how to use the `vxdg` command to reorganize disk groups. For more information about the `vxdg` command, see the `vxdg(1M)` manual page.

Listing Objects Potentially Affected by a Move

To display the VxVM objects that would be moved for a specified list of objects, use the following command:

```
# vxdg [-o expand] listmove sourcedg targetdg object ...
```

The following example lists the objects that would be affected by moving volume `vol1` from disk group `mydg` to `newdg`:

```
# vxdg listmove mydg newdg vol1
mydg01 c0t1d0 mydg05 c1t96d0 vol1 vol1-01 vol1-02 mydg01-01
mydg05-01
```

However, the following command produces an error because only a part of the volume `vol1` is configured on the disk `mydg01`:

```
# vxdg listmove mydg newdg mydg01
VxVM vxdg ERROR V-5-2-4597 vxdg listmove mydg newdg failed
VxVM vxdg ERROR V-5-2-3091 mydg05 : Disk not moving, but subdisks
on it are
```

Specifying the `-o expand` option, as shown below, ensures that the list of objects to be moved includes the other disks (in this case, `mydg05`) that are configured in `vol1`:

```
# vxdg -o expand listmove mydg newdg mydg01
mydg01 c0t1d0 mydg05 c1t96d0 vol1 vol1-01 vol1-02 mydg01-01
mydg05-01
```

Moving DCO Volumes Between Disk Groups

When you move the parent volume (such as a snapshot volume) to a different disk group, its DCO volume must accompany it. If you use the `vxassist addlog`, `vxmake` or `vxdco` commands to set up a DCO for a volume, you must ensure that the disks that contain the plexes of the DCO volume accompany their parent volume during the move. You can use the `vxprint` command on a volume to examine the configuration of its associated DCO volume.

If you use the `vxassist` command or the VERITAS Enterprise Administrator (VEA) to create both a volume and its DCO, or the `vxsnap prepare` command to add a DCO to a volume, the DCO plexes are automatically placed on different disks from the data plexes of the parent volume. In previous releases, version 0 DCO plexes were placed on the same disks as the data plexes for convenience when performing disk group split and move operations. As version 20 DCOs support dirty region logging (DRL) in addition to Persistent FastResync, it is preferable for the DCO plexes to be separated from the data plexes. This improves the performance of I/O from/to the volume, and provides resilience for the DRL logs.

[“Examples of Disk Groups That Can and Cannot be Split”](#) on page 162 illustrates some instances in which it is not possible to split a disk group because of the location of the DCO plexes on the disks of the disk group. For more information about relocating DCO plexes, see [“Specifying Storage for Version 0 DCO Plexes”](#) on page 308 and [“Specifying Storage for Version 20 DCO Plexes”](#) on page 236.

For more information about the layout of DCO volumes and their use with volume snapshots, see [“FastResync”](#) on page 49. For more information about the administration of volume snapshots, see [“Volume Snapshots”](#) on page 45 and [“Administering Volume Snapshots”](#) on page 261.



Examples of Disk Groups That Can and Cannot be Split

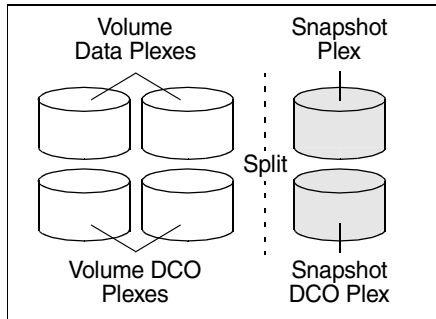

The disk group can be split as the DCO plexes are on dedicated disks, and can therefore accompany the disks that contain the volume data.

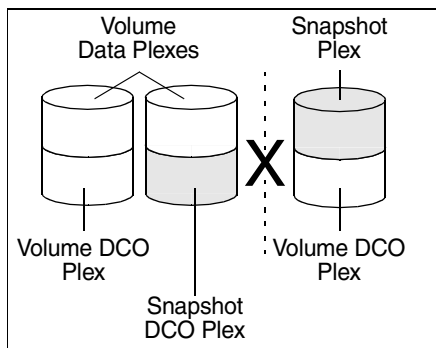

The disk group cannot be split as the DCO plexes cannot accompany their volumes. One solution is to relocate the DCO plexes. In this example, use an additional disk in the disk group as an intermediary to swap the misplaced DCO plexes. Alternatively, to improve DRL performance and resilience, allocate the DCO plexes to dedicated disks.

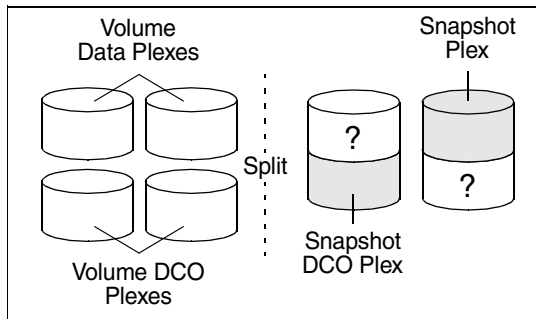

The disk group can be split as the DCO plexes can accompany their volumes. However, you may not wish the data in the portions of the disks marked “?” to be moved as well.

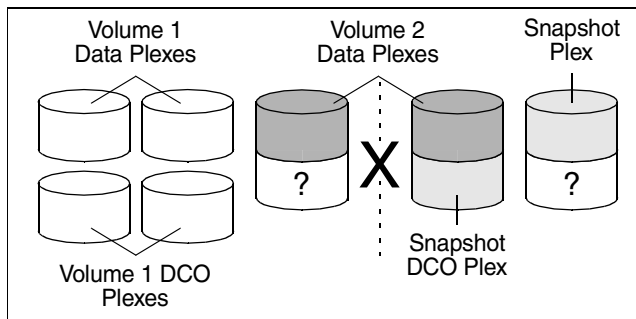

The disk group cannot be split as this would separate the disks that contain the data plexes of Volume 2. Possible solutions are to relocate the snapshot DCO plex to the disk containing the snapshot plex, or to another suitable disk that can be moved.

Moving Objects Between Disk Groups

To move a self-contained set of VxVM objects from an imported source disk group to an imported target disk group, use the following command:

```
# vxpdg [-o expand] [-o override|verify] move sourcedg targetdg\  
object ...
```

The `-o expand` option ensures that the objects that are actually moved include all other disks containing subdisks that are associated with the specified objects or with objects that they contain.

The default behavior of `vxpdg` when moving licensed disks in an EMC array is to perform an EMC disk compatibility check for each disk involved in the move. If the compatibility checks succeed, the move takes place. `vxpdg` then checks again to ensure that the configuration has not changed since it performed the compatibility check. If the configuration has changed, `vxpdg` attempts to perform the entire move again.

The `-o override` option enables the move to take place without any EMC checking.

The `-o verify` option returns the access names of the disks that would be moved but does not perform the move.

Note The `-o override` and `-o verify` options require a valid EMC license.

See “[Moving Objects Between Disk Groups](#)” on page 374 for information on how to move objects between disk groups in a cluster.

For example, the following output from `vxprint` shows the contents of disk groups `rootdg` and `mydg`:

```
# vxprint
Disk group: rootdg
TY NAME      ASSOC      KSTATE  LENGTH  PLOFFS  STATE  TUTILO  PUTILO
dg rootdg    rootdg     -        -        -        -        -
dm rootdg02  c1t97d0   -        17678493 -        -        -
dm rootdg03  c1t112d0  -        17678493 -        -        -
dm rootdg04  c1t114d0  -        17678493 -        -        -
dm rootdg06  c1t98d0   -        17678493 -        -        -

Disk group: mydg
TY NAME      ASSOC      KSTATE  LENGTH  PLOFFS  STATE  TUTILO  PUTILO
dg mydg      mydg       -        -        -        -        -
dm mydg01    c0t1d0    -        17678493 -        -        -
dm mydg05    c1t96d0   -        17678493 -        -        -
dm mydg07    c1t99d0   -        17678493 -        -        -
dm mydg08    c1t100d0  -        17678493 -        -        -
v  vol1      fsgen     ENABLED 2048    -        ACTIVE -        -
pl vol1-01   vol1      ENABLED 3591    -        ACTIVE -        -
```



```
sd mydg01-01 vol1-01    ENABLED 3591    0    -    -    -
pl vol1-02    vol1      ENABLED 3591    -    ACTIVE -    -
sd mydg05-01 vol1-02    ENABLED 3591    0    -    -    -
```

The following command moves the self-contained set of objects implied by specifying disk mydg01 from disk group mydg to rootdg:

```
# vxdbg -o expand move mydg rootdg mydg01
```

The moved volumes are initially disabled following the move. Use the following commands to recover and restart the volumes in the target disk group:

```
# vxrecover -g targetdg -m [volume ...]
# vxvol -g targetdg startall
```

The output from vxprint after the move shows that not only mydg01 but also volume vol1 and mydg05 have moved to rootdg, leaving only mydg07 and mydg08 in disk group mydg:

```
# vxprint
Disk group: rootdg
TY NAME      ASSOC      KSTATE  LENGTH  PLOFFS  STATE  TUTILO  PUTILO
dg rootdg    rootdg     -        -        -        -        -        -
dm mydg01    c0t1d0     -        17678493 -        -        -        -
dm rootdg02  c1t97d0    -        17678493 -        -        -        -
dm rootdg03  c1t112d0   -        17678493 -        -        -        -
dm rootdg04  c1t114d0   -        17678493 -        -        -        -
dm mydg05    c1t96d0    -        17678493 -        -        -        -
dm rootdg06  c1t98d0    -        17678493 -        -        -        -
v vol1       fsgen      ENABLED  2048    -        ACTIVE -        -
pl vol1-01   vol1       ENABLED  3591    -        ACTIVE -        -
sd mydg01-01 vol1-01    ENABLED  3591    0        -        -        -
pl vol1-02   vol1       ENABLED  3591    -        ACTIVE -        -
sd mydg05-01 vol1-02    ENABLED  3591    0        -        -        -
```

```
Disk group: mydg
TY NAME      ASSOC      KSTATE  LENGTH  PLOFFS  STATE  TUTILO  PUTILO
dg mydg      mydg       -        -        -        -        -        -
dm mydg07    c1t99d0    -        17678493 -        -        -        -
dm mydg08    c1t100d0   -        17678493 -        -        -        -
```

The following commands would also achieve the same result:

```
# vxdbg move mydg rootdg mydg01 mydg05
# vxdbg move mydg rootdg vol1
```

Splitting Disk Groups

To remove a self-contained set of VxVM objects from an imported source disk group to a new target disk group, use the following command:

```
# vxdbg [-o expand] [-o override|verify] split sourcedg targetdg \  
object ...
```

For a description of the `-o expand`, `-o override`, and `-o verify` options, see “[Moving Objects Between Disk Groups](#)” on page 163.

See “[Splitting Disk Groups](#)” on page 375 for more information on splitting shared disk groups in clusters.

For example, the following output from `vxprint` shows the contents of disk group `rootdg`:

```
# vxprint
Disk group: rootdg
TY NAME      ASSOC      KSTATE  LENGTH  PLOFFS  STATE  TUTILO  PUTILO
dg rootdg    rootdg     -        -        -        -        -
dm rootdg01  c0t1d0    -        17678493 -        -        -
dm rootdg02  c1t97d0   -        17678493 -        -        -
dm rootdg03  c1t112d0  -        17678493 -        -        -
dm rootdg04  c1t114d0  -        17678493 -        -        -
dm rootdg05  c1t96d0   -        17678493 -        -        -
dm rootdg06  c1t98d0   -        17678493 -        -        -
dm rootdg07  c1t99d0   -        17678493 -        -        -
dm rootdg08  c1t100d0  -        17678493 -        -        -
v  vol1      fsgen     ENABLED 2048    -        ACTIVE -
pl vol1-01   vol1      ENABLED 3591    -        ACTIVE -
sd rootdg01-01 vol1-01  ENABLED 3591    0        -        -
pl vol1-02   vol1      ENABLED 3591    -        ACTIVE -
sd rootdg05-01 vol1-02  ENABLED 3591    0        -        -
```

The following command removes disks `rootdg07` and `rootdg08` from `rootdg` to form a new disk group, `mydg`:

```
# vxdbg -o expand split rootdg mydg rootdg07 rootdg08
```

The moved volumes are initially disabled following the split. Use the following commands to recover and restart the volumes in the new target disk group:

```
# vxrecover -g targetdg -m [volume ...]
# vxvol -g targetdg startall
```



The output from `vxprint` after the split shows the new disk group, `mydg`:

```
# vxprint
Disk group: rootdg
TY NAME      ASSOC      KSTATE  LENGTH    PLOFFS  STATE  TUTILO  PUTILO
dg rootdg    rootdg     -        -         -        -        -
dm rootdg01  c0t1d0     -        17678493 -         -        -
dm rootdg02  c1t97d0    -        17678493 -         -        -
dm rootdg03  c1t112d0   -        17678493 -         -        -
dm rootdg04  c1t114d0   -        17678493 -         -        -
dm rootdg05  c1t96d0    -        17678493 -         -        -
dm rootdg06  c1t98d0    -        17678493 -         -        -
v  vol1      fsgen      ENABLED  2048     -         ACTIVE -
pl vol1-01   vol1       ENABLED  3591     -         ACTIVE -
sd rootdg01-01 vol1-01  ENABLED  3591     0         -        -
pl vol1-02   vol1       ENABLED  3591     -         ACTIVE -
sd rootdg05-01 vol1-02  ENABLED  3591     0         -        -

Disk group: mydg
TY NAME      ASSOC      KSTATE  LENGTH    PLOFFS  STATE  TUTILO  PUTILO
dg mydg      mydg       -        -         -        -        -
dm rootdg07  c1t99d0    -        17678493 -         -        -
dm rootdg08  c1t100d0   -        17678493 -         -        -
```

Joining Disk Groups

To remove all VxVM objects from an imported source disk group to an imported target disk group, use the following command:

```
# vxdg [-o override|verify] join sourcedg targetdg
```

Note You cannot specify `rootdg` as the source disk group for a `join` operation.

For a description of the `-o override` and `-o verify` options, see [“Moving Objects Between Disk Groups”](#) on page 163.

See [“Joining Disk Groups”](#) on page 375 for information on joining disk groups in a cluster.

For example, the following output from `vxprint` shows the contents of the disk group `rootdg` and `mydg`:

```
# vxprint
Disk group: rootdg
TY NAME      ASSOC      KSTATE  LENGTH    PLOFFS  STATE  TUTILO  PUTILO
dg rootdg    rootdg     -        -         -        -        -
dm rootdg01  c0t1d0     -        17678493 -         -        -
dm rootdg02  c1t97d0    -        17678493 -         -        -
```

```

dm rootdg03 c1t112d0 - 17678493 - - -
dm rootdg04 c1t114d0 - 17678493 - - -
dm rootdg07 c1t99d0 - 17678493 - - -
dm rootdg08 c1t100d0 - 17678493 - - -

```

Disk group: mydg

TY	NAME	ASSOC	KSTATE	LENGTH	PLOFFS	STATE	TUTIL0	PUTIL0
dg	mydg	mydg	-	-	-	-	-	-
dm	mydg05	c1t96d0	-	17678493	-	-	-	-
dm	mydg06	c1t98d0	-	17678493	-	-	-	-
v	vol1	fsgen	ENABLED	2048	-	ACTIVE	-	-
pl	vol1-01	vol1	ENABLED	3591	-	ACTIVE	-	-
sd	mydg01-01	vol1-01	ENABLED	3591	0	-	-	-
pl	vol1-02	vol1	ENABLED	3591	-	ACTIVE	-	-
sd	mydg05-01	vol1-02	ENABLED	3591	0	-	-	-

The following command joins disk group mydg to rootdg:

```
# vxvg join mydg rootdg
```

The moved volumes are initially disabled following the join. Use the following commands to recover and restart the volumes in the target disk group:

```
# vxrecover -g targetdg -m [volume ...]
# vxvol -g targetdg startall
```

The output from vxprint after the join shows that disk group mydg has been removed:

```

# vxprint
Disk group: rootdg
TY NAME ASSOC KSTATE LENGTH PLOFFS STATE TUTIL0 PUTIL0
dg rootdg rootdg - - - - -
dm mydg01 c0t1d0 - 17678493 - - -
dm rootdg02 c1t97d0 - 17678493 - - -
dm rootdg03 c1t112d0 - 17678493 - - -
dm rootdg04 c1t114d0 - 17678493 - - -
dm mydg05 c1t96d0 - 17678493 - - -
dm rootdg06 c1t98d0 - 17678493 - - -
dm rootdg07 c1t99d0 - 17678493 - - -
dm rootdg08 c1t100d0 - 17678493 - - -
v vol1 fsgen ENABLED 2048 - ACTIVE -
pl vol1-01 vol1 ENABLED 3591 - ACTIVE -
sd mydg01-01 vol1-01 ENABLED 3591 0 - -
pl vol1-02 vol1 ENABLED 3591 - ACTIVE -
sd mydg05-01 vol1-02 ENABLED 3591 0 - -

```



Disabling a Disk Group

To disable a disk group, unmount and stop any volumes in the disk group, and then use the following command to deport it:

```
# vxdg deport diskgroup
```

Deporting a disk group does not actually remove the disk group. It disables use of the disk group by the system. Disks in a deported disk group can be reused, reinitialized, added to other disk groups, or imported for use on other systems. Use the `vxdg import` command to re-enable access to the disk group.

Destroying a Disk Group

The `vxdg` command provides a `destroy` option that removes a disk group from the system and frees the disks in that disk group for reinitialization:

```
# vxdg destroy diskgroup
```

Caution This command destroys all data on the disks.

When a disk group is destroyed, the disks that are released can be re-used in other disk groups.

Recovering a Destroyed Disk Group

If a disk group has been accidentally destroyed, you can use the following procedure to recover it, provided that the disks that were in the disk group have not been modified or reused elsewhere:

1. Enter the following command to find out the disk group ID (*dgid*) of one of the disks that was in the disk group:

```
# vxdisk -s list disk_access_name
```

The disk must be specified by its disk access name, such as `c0t12d0`. Examine the output from the command for a line similar to the following that specifies the disk group ID.

```
dgid: 963504895.1075.bass
```

2. Use the disk group ID to import the disk group:

```
# vxdg import dgid
```

Upgrading a Disk Group

Note On some platforms, the first release of VERITAS Volume Manager was 3.0 or 3.2.

Prior to the release of VERITAS Volume Manager 3.0, the disk group version was automatically upgraded (if needed) when the disk group was imported.

From release 3.0 of VERITAS Volume Manager, the two operations of importing a disk group and upgrading its version are separate. You can import a disk group from a previous version and use it without upgrading it.

When you want to use new features, the disk group can be upgraded. The upgrade is an explicit operation. Once the upgrade occurs, the disk group becomes incompatible with earlier releases of VxVM that do not support the new version.

Before the imported disk group is upgraded, no changes are made to the disk group to prevent its use on the release from which it was imported until you explicitly upgrade it to the current release.

Until completion of the upgrade, the disk group can be used “as is” provided there is no attempt to use the features of the current version. Attempts to use a feature of the current version that is not a feature of the version from which the disk group was imported results in an error message similar to this:

```
VxVM vxedit ERROR V-5-1-2829 Disk group version doesn't support
feature
```

To use any of the new features, you must run the `vx dg upgrade` command to explicitly upgrade the disk group to a version that supports those features.

All disk groups have a version number associated with them. VERITAS Volume Manager releases support a specific set of disk group versions. VxVM can import and perform operations on a disk group of that version. The operations are limited by what features and operations the disk group version supports.



The table, “[Disk Group Version Assignments](#),” summarizes the VERITAS Volume Manager releases that introduce and support specific disk group versions:

Disk Group Version Assignments

VxVM Release	Introduces Disk Group Version	Supports Disk Group Versions
1.2	10	10
1.3	15	15
2.0	20	20
2.2	30	30
2.3	40	40
2.5	50	50
3.0	60	20-40, 60
3.1	70	20-70
3.1.1	80	20-80
3.2, 3.5	90	20-90
4.0	110	20-110
4.1	120	20-120

Importing the disk group of a previous version on a VERITAS Volume Manager system prevents the use of features introduced since that version was released. The table, “[Features Supported by Disk Group Versions](#),” summarizes the features that are supported by disk group versions 20 through 120:



Features Supported by Disk Group Versions

Disk Group Version	New Features Supported	Previous Version Features Supported
120	<ul style="list-style-type: none"> ◆ Automatic Cluster-wide Failback for A/P arrays ◆ DMP Co-existence with Third-Party Drivers ◆ Migration of Volumes to ISP ◆ Persistent DMP Policies ◆ Shared Disk Group Failure Policy 	20, 30, 40, 50, 60, 70, 80, 90, 110
110	<ul style="list-style-type: none"> ◆ Cross-platform Data Sharing (CDS) ◆ Device Discovery Layer (DDL) 2.0 ◆ Disk Group Configuration Backup and Restore ◆ Elimination of rootdg as a Special Disk Group ◆ Full-Sized and Space-Optimized Instant Snapshots ◆ Intelligent Storage Provisioning (ISP) ◆ Serial Split Brain Detection ◆ Volume Sets (Multiple Device Support for VxFS) 	20, 30, 40, 50, 60, 70, 80, 90
90	<ul style="list-style-type: none"> ◆ Cluster Support for Oracle Resilvering ◆ Disk Group Move, Split and Join ◆ Device Discovery Layer (DDL) 1.0 ◆ Layered Volume Support in Clusters ◆ Ordered Allocation ◆ OS Independent Naming Support ◆ Persistent FastResync 	20, 30, 40, 50, 60, 70, 80
80	<ul style="list-style-type: none"> ◆ VERITAS Volume Replicator (VVR) Enhancements 	20, 30, 40, 50, 60, 70
70	<ul style="list-style-type: none"> ◆ Non-Persistent FastResync ◆ Sequential DRL ◆ Unrelocate ◆ VERITAS Volume Replicator (VVR) Enhancements 	20, 30, 40, 50, 60
60	<ul style="list-style-type: none"> ◆ Online Relayout ◆ Safe RAID-5 Subdisk Moves 	20, 30, 40
50	<ul style="list-style-type: none"> ◆ SRVM (now known as VERITAS Volume Replicator or VVR) 	20, 30, 40
40	<ul style="list-style-type: none"> ◆ Hot-Relocation 	20, 30
30	<ul style="list-style-type: none"> ◆ VxSmartSync Recovery Accelerator 	20



Features Supported by Disk Group Versions

Disk Group Version	New Features Supported	Previous Version Features Supported
20	<ul style="list-style-type: none"> ◆ Dirty Region Logging (DRL) ◆ Disk Group Configuration Copy Limiting ◆ Mirrored Volumes Logging ◆ New-Style Stripes ◆ RAID-5 Volumes ◆ Recovery Checkpointing 	

To list the version of a disk group, use this command:

```
# vx dg list dgname
```

You can also determine the disk group version by using the `vxprint` command with the `-l` format option.

To upgrade a disk group to the highest version supported by the release of VxVM that is currently running, use this command:

```
# vx dg upgrade dgname
```

By default, VxVM creates a disk group of the highest version supported by the release. For example, VERITAS Volume Manager 4.1 creates disk groups with version 120.

It may sometimes be necessary to create a disk group for an older version. The default disk group version for a disk group created on a system running VERITAS Volume Manager 4.1 is 120. Such a disk group cannot be imported on a system running VERITAS Volume Manager 2.3, as that release only supports up to version 40. Therefore, to create a disk group on a system running VERITAS Volume Manager 4.1 that can be imported by a system running VERITAS Volume Manager 2.3, the disk group must be created with a version of 40 or less.

To create a disk group with a previous version, specify the `-T version` option to the `vx dg init` command. For example, to create a disk group with version 40 that can be imported by a system running VxVM 2.3, use the following command:

```
# vx dg -T 40 init newdg newdg01=c0t3d0
```

This creates a disk group, `newdg`, which can be imported by VERITAS Volume Manager 2.3. Note that while this disk group can be imported on the VxVM 2.3 system, attempts to use features from VERITAS Volume Manager 3.0 and later releases will fail.

Managing the Configuration Daemon in VxVM

The VxVM configuration daemon (`vxconfigd`) provides the interface between VxVM commands and the kernel device drivers. `vxconfigd` handles configuration change requests from VxVM utilities, communicates the change requests to the VxVM kernel, and modifies configuration information stored on disk. `vxconfigd` also initializes VxVM when the system is booted.

The `vxctl` command is the command-line interface to the `vxconfigd` daemon.

You can use `vxctl` to:

- ◆ Control the operation of the `vxconfigd` daemon.
- ◆ Change the system-wide definition of the default disk group.

Note In VxVM 4.0 and later releases, disk access records are no longer stored in the `/etc/volboot` file. Non-persistent disk access records are created by scanning the disks at system startup. Persistent disk access records for `simple` and `nopriv` disks are permanently stored in the `/etc/vx/darecs` file in the root file system. The `vxconfigd` daemon reads the contents of this file to locate the disks and the configuration databases for their disk groups. (The `/etc/vx/darecs` file is also used to store definitions of foreign devices that are not autoconfigurable. Such entries may be added by using the `vxddladm addforeign` command. See the `vxddladm(1M)` manual page for more information.)

If your system is configured to use Dynamic Multipathing (DMP), you can also use `vxctl` to:

- ◆ Reconfigure the DMP database to include disk devices newly attached to, or removed from the system.
- ◆ Create DMP device nodes in the directories `/dev/vx/dmp` and `/dev/vx/rdmp`.
- ◆ Update the DMP database with changes in path type for active/passive disk arrays. Use the utilities provided by the disk-array vendor to change the path type between primary and secondary.

For more information about how to use `vxctl`, refer to the `vxctl(1M)` manual page.



Backing Up and Restoring Disk Group Configuration Data

The disk group configuration backup and restoration feature allows you to back up and restore all configuration data for disk groups, and for VxVM objects such as volumes that are configured within the disk groups. The `vxconfigbackupd` daemon monitors changes to the VxVM configuration and automatically records any configuration changes that occur. Two utilities, `vxconfigbackup` and `vxconfigrestore`, are provided for backing up and restoring a VxVM configuration for a disk group.

For information on backing up and restoring disk group configurations, see the “Backing Up and Restoring Disk Group Configurations” chapter in the *VERITAS Volume Manager Troubleshooting Guide*, and the `vxconfigbackup(1M)` and `vxconfigrestore(1M)` manual pages.

Using `vxnotify` to Monitor Configuration Changes

You can use the `vxnotify` utility to display events relating to disk and configuration changes that are managed by the `vxconfigd` configuration daemon. If `vxnotify` is running on a system where the VxVM clustering feature is active, it displays events that are related to changes in the cluster state of the system on which it is running. The `vxnotify` utility displays the requested event types until you kill it, until it has received a specified number of events, or until a specified period of time has elapsed.

Examples of configuration events that can be detected include disabling and enabling of controllers, paths and DMP nodes, RAID-5 volumes entering degraded mode, detachment of disks, plexes and volumes, and nodes joining and leaving a cluster.

For example, the following `vxnotify` command displays information about all disk, plex, and volume detachments as they occur:

```
# vxnotify -f
```

The following command provides information about cluster configuration changes, including the import and deport of shared disk groups:

```
# vxnotify -s -i
```

For more information about the `vxnotify` utility, and the types of configuration events that it can report, see the `vxnotify(1M)` manual page.

Creating and Administering Subdisks

5

This chapter describes how to create and maintain *subdisks*. Subdisks are the low-level building blocks in a VERITAS Volume Manager (VxVM) configuration that are required to create plexes and volumes.

Note Most VxVM commands require superuser or equivalent privileges.

Creating Subdisks

Note Subdisks are created automatically if you use the `vxassist` command or the VERITAS Enterprise Administrator (VEA) to create volumes. For more information, see “[Creating a Volume](#)” on page 198.

Use the `vxmake` command to create VxVM objects, such as subdisks:

```
# vxmake [-g diskgroup] sd subdisk diskname, offset, length
```

where: *subdisk* is the name of the subdisk, *diskname* is the disk name, *offset* is the starting point (offset) of the subdisk within the disk, and *length* is the length of the subdisk.

For example, to create a subdisk named `mydg02-01` in the disk group, `mydg`, that starts at the beginning of disk `mydg02` and has a length of 8000 sectors, use the following command:

```
# vxmake -g mydg sd mydg02-01 mydg02,0,8000
```

Note As for all VxVM commands, the default size unit is `s`, representing a sector. Add a suffix, such as `k` for kilobyte, `m` for megabyte or `g` for gigabyte, to change the unit of size. For example, `500m` would represent 500 megabytes.

If you intend to use the new subdisk to build a volume, you must associate the subdisk with a plex (see “[Associating Subdisks with Plexes](#)” on page 178). Subdisks for all plex layouts (concatenated, striped, RAID-5) are created the same way.



Displaying Subdisk Information

The `vxprint` command displays information about VxVM objects. To display general information for all subdisks, use this command:

```
# vxprint -st
```

The `-s` option specifies information about subdisks. The `-t` option prints a single-line output record that depends on the type of object being listed.

The following is example output:

SD NAME	PLEX	DISK	DISKOFFS	LENGTH	[COL/]OFF	DEVICE	MODE
SV NAME	PLEX	VOLNAME	NVOLLAYR	LENGTH	[COL/]OFF	AM/NM	MODE
sd mydg01-01	vol11-01	mydg01	0	102400	0	c2t0d1	ENA
sd mydg02-01	vol12-01	mydg02	0	102400	0	c2t1d1	ENA

You can display complete information about a particular subdisk by using this command:

```
# vxprint [-g diskgroup] -l subdisk
```

For example, the following command displays all information for subdisk `mydg02-01` in the disk group, `mydg`:

```
# vxprint -g mydg -l mydg02-01
```

This command provides the following output:

```
Disk group: mydg
Subdisk: mydg02-01
info: disk=mydg02 offset=0 len=205632
assoc: vol=mvol plex=mvol-02 (offset=0)
flags: enabled
device: device=c2t1d1 path=/dev/vx/dmp/c2t1d1 diskdev=32/68
```

Moving Subdisks

Moving a subdisk copies the disk space contents of a subdisk onto one or more other subdisks. If the subdisk being moved is associated with a plex, then the data stored on the original subdisk is copied to the new subdisks. The old subdisk is dissociated from the plex, and the new subdisks are associated with the plex. The association is at the same offset within the plex as the source subdisk. To move a subdisk, use the following command:

```
# vxsd [-g diskgroup] mv old_subdisk new_subdisk [new_subdisk ...]
```

For example, if `mydg03` in the disk group, `mydg`, is to be evacuated, and `mydg12` has enough room on two of its subdisks, use the following command:

```
# vxsd -g mydg mv mydg03-01 mydg12-01 mydg12-02
```



For the subdisk move to work correctly, the following conditions must be met:

- ◆ The subdisks involved must be the same size.
- ◆ The subdisk being moved must be part of an active plex on an active (ENABLED) volume.
- ◆ The new subdisk must not be associated with any other plex.

See “[Configuring Hot-Relocation to Use Only Spare Disks](#)” on page 339 for information about manually relocating subdisks after hot-relocation.

Splitting Subdisks

Splitting a subdisk divides an existing subdisk into two separate subdisks. To split a subdisk, use the following command:

```
# vxsd [-g diskgroup] -s size split subdisk newsd1 newsd2
```

where *subdisk* is the name of the original subdisk, *newsd1* is the name of the first of the two subdisks to be created and *newsd2* is the name of the second subdisk to be created.

The `-s` option is required to specify the size of the *first* of the two subdisks to be created. The second subdisk occupies the remaining space used by the original subdisk.

If the original subdisk is associated with a plex before the task, upon completion of the split, both of the resulting subdisks are associated with the same plex.

To split the original subdisk into more than two subdisks, repeat the previous command as many times as necessary on the resulting subdisks.

For example, to split subdisk `mydg03-02`, with size 2000 megabytes into subdisks `mydg03-02`, `mydg03-03`, `mydg03-04` and `mydg03-05`, each with size 500 megabytes, all in the disk group, `mydg`, use the following commands:

```
# vxsd -g mydg -s 1000m split mydg03-02 mydg03-02 mydg03-04
# vxsd -g mydg -s 500m split mydg03-02 mydg03-02 mydg03-03
# vxsd -g mydg -s 500m split mydg03-04 mydg03-04 mydg03-05
```

Joining Subdisks

Joining subdisks combines two or more existing subdisks into one subdisk. To join subdisks, the subdisks must be contiguous on the same disk. If the selected subdisks are associated, they must be associated with the same plex, and be contiguous in that plex. To join several subdisks, use the following command:

```
# vxsd [-g diskgroup] join subdisk1 subdisk2 ... new_subdisk
```



For example, to join the contiguous subdisks `mydg03-02`, `mydg03-03`, `mydg03-04` and `mydg03-05` as subdisk `mydg03-02` in the disk group, `mydg`, use the following command:

```
# vxsd -g mydg join mydg03-02 mydg03-03 mydg03-04 mydg03-05 \
mydg03-02
```

Associating Subdisks with Plexes

Associating a subdisk with a plex places the amount of disk space defined by the subdisk at a specific offset within the plex. The entire area that the subdisk fills must not be occupied by any portion of another subdisk. There are several ways that subdisks can be associated with plexes, depending on the overall state of the configuration.

If you have already created all the subdisks needed for a particular plex, to associate subdisks at plex creation, use the following command:

```
# vxmake [-g diskgroup] plex plex sd=subdisk,...
```

For example, to create the plex `home-1` and associate subdisks `mydg02-01`, `mydg02-00`, and `mydg02-02` with plex `home-1`, all in the disk group, `mydg`, use the following command:

```
# vxmake -g mydg plex home-1 sd=mydg02-01,mydg02-00,mydg02-02
```

Subdisks are associated in order starting at offset 0. If you use this type of command, you do not have to specify the multiple commands needed to create the plex and then associate each of the subdisks with that plex. In this example, the subdisks are associated to the plex in the order they are listed (after `sd=`). The disk space defined as `mydg02-01` is first, `mydg02-00` is second, and `mydg02-02` is third. This method of associating subdisks is convenient during initial configuration.

Subdisks can also be associated with a plex that already exists. To associate one or more subdisks with an existing plex, use the following command:

```
# vxsd [-g diskgroup] assoc plex subdisk1 [subdisk2 subdisk3 ...]
```

For example, to associate subdisks named `mydg02-01`, `mydg02-00`, and `mydg02-02` with a plex named `home-1`, use the following command:

```
# vxsd -g mydg assoc home-1 mydg02-01 mydg02-00 mydg02-01
```

If the plex is not empty, the new subdisks are added after any subdisks that are already associated with the plex, unless the `-l` option is specified with the command. The `-l` option associates subdisks at a specific offset within the plex.

The `-l` option is required if you previously created a sparse plex (that is, a plex with portions of its address space that do not map to subdisks) for a particular volume, and subsequently want to make the plex complete. To complete the plex, create a subdisk of a

size that fits the hole in the sparse plex exactly. Then, associate the subdisk with the plex by specifying the offset of the beginning of the hole in the plex, using the following command:

```
# vxsd [-g diskgroup] -l offset assoc sparse_plex exact_size_subdisk
```

Note The subdisk must be exactly the right size. VxVM does not allow the space defined for two subdisks to overlap within a plex.

For striped or RAID-5 plexes, use the following command to specify a column number and column offset for the subdisk to be added:

```
# vxsd [-g diskgroup] -l column_#/offset assoc plex subdisk ...
```

If only one number is specified with the `-l` option for striped plexes, the number is interpreted as a column number and the subdisk is associated at the end of the column.

Alternatively, to add M subdisks at the end of each of the N columns in a striped or RAID-5 volume, you can use the following form of the `vxsd` command:

```
# vxsd [-g diskgroup] assoc plex subdisk1:0 ... subdiskM:N-1
```

The following example shows how to append three subdisk to the ends of the three columns in a striped plex, `vol-01`, in the disk group, `mydg`:

```
# vxsd -g mydg assoc vol01-01 mydg10-01:0 mydg11-01:1 mydg12-01:2
```

If a subdisk is filling a “hole” in the plex (that is, some portion of the volume logical address space is mapped by the subdisk), the subdisk is considered stale. If the volume is enabled, the association operation regenerates data that belongs on the subdisk. Otherwise, it is marked as stale and is recovered when the volume is started.

Associating Log Subdisks

Note The version 20 DCO volume layout includes space for a DRL. Do not apply the procedure described in this section to a volume that has a version 20 DCO volume associated with it. See [“Preparing a Volume for DRL and Instant Snapshots”](#) on page 235 for more information.

Log subdisks are defined and added to a plex that is to become part of a volume on which dirty region logging (DRL) is enabled. DRL is enabled for a volume when the volume is mirrored and has at least one log subdisk.

For a description of DRL, see [“Dirty Region Logging \(DRL\)”](#) on page 42. Log subdisks are ignored as far as the usual plex policies are concerned, and are only used to hold the dirty region log.



Note Only one log subdisk can be associated with a plex. Because this log subdisk is frequently written, care should be taken to position it on a disk that is not heavily used. Placing a log subdisk on a heavily-used disk can degrade system performance.

To add a log subdisk to an existing plex, use the following command:

```
# vxsd [-g diskgroup] aslog plex subdisk
```

where *subdisk* is the name to be used for the log subdisk. The plex must be associated with a mirrored volume before dirty region logging takes effect.

For example, to associate a subdisk named `mydg02-01` with a plex named `vol101-02`, which is already associated with volume `vol101` in the disk group, `mydg`, use the following command:

```
# vxsd -g mydg aslog vol101-02 mydg02-01
```

You can also add a log subdisk to an existing volume with the following command:

```
# vxassist [-g diskgroup] addlog volume disk
```

This command automatically creates a log subdisk within a log plex on the specified disk for the specified volume.

Dissociating Subdisks from Plexes

To break an established connection between a subdisk and the plex to which it belongs, the subdisk is *dissociated* from the plex. A subdisk is dissociated when the subdisk is removed or used in another plex. To dissociate a subdisk, use the following command:

```
# vxsd [-g diskgroup] dis subdisk
```

For example, to dissociate a subdisk named `mydg02-01` from the plex with which it is currently associated in the disk group, `mydg`, use the following command:

```
# vxsd -g mydg dis mydg02-01
```

You can additionally remove the dissociated subdisks from VxVM control using the following form of the command:

```
# vxsd [-g diskgroup] -o rm dis subdisk
```

Caution If the subdisk maps a portion of a volume's address space, dissociating it places the volume in DEGRADED mode. In this case, the `dis` operation prints a warning and must be forced using the `-o force` option to succeed. Also, if

removing the subdisk makes the volume unusable, because another subdisk in the same stripe is unusable or missing and the volume is not DISABLED and empty, the operation is not allowed.

Removing Subdisks

To remove a subdisk, use the following command:

```
# vxedit [-g diskgroup] rm subdisk
```

For example, to remove a subdisk named `mydg02-01` from the disk group, `mydg`, use the following command:

```
# vxedit -g mydg rm mydg02-01
```



Changing Subdisk Attributes

Caution Change subdisk attributes with extreme care.

The `vxedit` command changes attributes of subdisks and other VxVM objects. To change subdisk attributes, use the following command:

```
# vxedit [-g diskgroup] set attribute=value ... subdisk ...
```

Subdisk fields that can be changed using the `vxedit` command include:

- ◆ `name`
- ◆ `putiln`
- ◆ `tutiln`
- ◆ `len`
- ◆ `comment`

The `putiln` field attributes are maintained on reboot; `tutiln` fields are temporary and are not retained on reboot. VxVM sets the `putil0` and `tutil0` utility fields. Other VERITAS products, such as the VERITAS Enterprise Administrator (VEA), set the `putil1` and `tutil1` fields. The `putil2` and `tutil2` are available for you to use for site-specific purposes. The length field, `len`, can only be changed if the subdisk is dissociated.

For example, to change the `comment` field of a subdisk named `mydg02-01` in the disk group, `mydg`, use the following command:

```
# vxedit -g mydg set comment="subdisk comment" mydg02-01
```

To prevent a particular subdisk from being associated with a plex, set the `putil0` field to a non-null string, as shown in the following command:

```
# vxedit -g mydg set putil0="DO-NOT-USE" mydg02-01
```

See the `vxedit(1M)` manual page for more information about using the `vxedit` command to change the attribute fields of VxVM objects.

Creating and Administering Plexes

6

This chapter describes how to create and maintain *plexes*. Plexes are logical groupings of subdisks that create an area of disk space independent of physical disk size or other restrictions. Replication (mirroring) of disk data is set up by creating multiple data plexes for a single volume. Each data plex in a mirrored volume contains an identical copy of the volume data. Because each data plex must reside on different disks from the other plexes, the replication provided by mirroring prevents data loss in the event of a single-point disk-subsystem failure. Multiple data plexes also provide increased data integrity and reliability.

Note Most VxVM commands require superuser or equivalent privileges.

Creating Plexes

Note Plexes are created automatically if you use the `vxassist` command or the VERITAS Enterprise Administrator (VEA) to create volumes. For more information, see [“Creating a Volume”](#) on page 198.

Use the `vxmake` command to create VxVM objects, such as plexes. When creating a plex, identify the subdisks that are to be associated with it:

To create a plex from existing subdisks, use the following command:

```
# vxmake [-g diskgroup] plex plex sd=subdisk1[,subdisk2,...]
```

For example, to create a concatenated plex named `vol101-02` from two existing subdisks named `mydg02-01` and `mydg02-02` in the disk group, `mydg`, use the following command:

```
# vxmake -g mydg plex vol101-02 sd=mydg02-01,mydg02-02
```



Creating a Striped Plex

To create a striped plex, you must specify additional attributes. For example, to create a striped plex named `p1-01` in the disk group, `mydg`, with a stripe width of 32 sectors and 2 columns, use the following command:

```
# vxmake -g mydg plex p1-01 layout=stripe stwidth=32 ncolumn=2 \  
sd=mydg01-01,mydg02-01
```

To use a plex to build a volume, you must associate the plex with the volume. For more information, see the section, “[Attaching and Associating Plexes](#)” on page 189.

Displaying Plex Information

Listing plexes helps identify free plexes for building volumes. Use the `plex (-p)` option to the `vxprint` command to list information about all plexes.

To display detailed information about all plexes in the system, use the following command:

```
# vxprint -lp
```

To display detailed information about a specific plex, use the following command:

```
# vxprint [-g diskgroup] -l plex
```

The `-t` option prints a single line of information about the plex. To list free plexes, use the following command:

```
# vxprint -pt
```

The following section describes the meaning of the various plex states that may be displayed in the `STATE` field of `vxprint` output.

Plex States

Plex states reflect whether or not plexes are complete and are consistent copies (mirrors) of the volume contents. VxVM utilities automatically maintain the plex state. However, if a volume should not be written to because there are changes to that volume and if a plex is associated with that volume, you can modify the state of the plex. For example, if a disk with a particular plex located on it begins to fail, you can temporarily disable that plex.

Note A plex does not have to be associated with a volume. A plex can be created with the `vxmake plex` command and be attached to a volume later.

VxVM utilities use plex states to:

- ◆ indicate whether volume contents have been initialized to a known state
- ◆ determine if a plex contains a valid copy (mirror) of the volume contents
- ◆ track whether a plex was in active use at the time of a system failure
- ◆ monitor operations on plexes

This section explains the individual plex states in detail. For more information about the possible transitions between plex states and how these are applied during volume recovery, see the chapter “Understanding the Plex State Cycle” in the section “Recovery from Hardware Failure” in the *VERITAS Volume Manager Troubleshooting Guide*.

Plexes that are associated with a volume have one of the following states:

ACTIVE Plex State

A plex can be in the ACTIVE state in two ways:

- ◆ when the volume is started and the plex fully participates in normal volume I/O (the plex contents change as the contents of the volume change)
- ◆ when the volume is stopped as a result of a system crash and the plex is ACTIVE at the moment of the crash

In the latter case, a system failure can leave plex contents in an inconsistent state. When a volume is started, VxVM does the recovery action to guarantee that the contents of the plexes marked as ACTIVE are made identical.

Note On a system running well, ACTIVE should be the most common state you see for any volume plexes.

CLEAN Plex State

A plex is in a CLEAN state when it is known to contain a consistent copy (mirror) of the volume contents and an operation has disabled the volume. As a result, when all plexes of a volume are clean, no action is required to guarantee that the plexes are identical when that volume is started.

DCOSNP Plex State

This state indicates that a data change object (DCO) plex attached to a volume can be used by a snapshot plex to create a DCO volume during a snapshot operation.



EMPTY Plex State

Volume creation sets all plexes associated with the volume to the EMPTY state to indicate that the plex is not yet initialized.

IOFAIL Plex State

The IOFAIL plex state is associated with persistent state logging. When the `vxconfigd` daemon detects an uncorrectable I/O failure on an ACTIVE plex, it places the plex in the IOFAIL state to exclude it from the recovery selection process at volume start time.

This state indicates that the plex is out-of-date with respect to the volume, and that it requires complete recovery. It is likely that one or more of the disks associated with the plex should be replaced.

LOG Plex State

The state of a dirty region logging (DRL) or RAID-5 log plex is always set to LOG.

OFFLINE Plex State

The `vxmend off` task indefinitely detaches a plex from a volume by setting the plex state to OFFLINE. Although the detached plex maintains its association with the volume, changes to the volume do not update the OFFLINE plex. The plex is not updated until the plex is put online and reattached with the `vxplex att` task. When this occurs, the plex is placed in the STALE state, which causes its contents to be recovered at the next `vxvol start` operation.

SNAPATT Plex State

This state indicates a snapshot plex that is being attached by the snapstart operation. When the attach is complete, the state for the plex is changed to SNAPDONE. If the system fails before the attach completes, the plex and all of its subdisks are removed.

SNAPDIS Plex State

This state indicates a snapshot plex that is fully attached. A plex in this state can be turned into a snapshot volume with the `vxplex snapshot` command. If the system fails before the attach completes, the plex is dissociated from the volume. See the `vxplex(1M)` manual page for more information.

SNAPDONE Plex State

The SNAPDONE plex state indicates that a snapshot plex is ready for a snapshot to be taken using `vxassist snapshot`.

SNAPTMP Plex State

The SNAPTMP plex state is used during a `vxassist snapstart` operation when a snapshot is being prepared on a volume.

STALE Plex State

If there is a possibility that a plex does not have the complete and current volume contents, that plex is placed in the STALE state. Also, if an I/O error occurs on a plex, the kernel stops using and updating the contents of that plex, and the plex state is set to STALE.

A `vxplex att` operation recovers the contents of a STALE plex from an ACTIVE plex. Atomic copy operations copy the contents of the volume to the STALE plexes. The system administrator can force a plex to the STALE state with a `vxplex det` operation.

TEMP Plex State

Setting a plex to the TEMP state eases some plex operations that cannot occur in a truly atomic fashion. For example, attaching a plex to an enabled volume requires copying volume contents to the plex before it can be considered fully attached.

A utility sets the plex state to TEMP at the start of such an operation and to an appropriate state at the end of the operation. If the system fails for any reason, a TEMP plex state indicates that the operation is incomplete. A later `vxvol start` dissociates plexes in the TEMP state.

TEMPRM Plex State

A TEMPRM plex state is similar to a TEMP state except that at the completion of the operation, the TEMPRM plex is removed. Some subdisk operations require a temporary plex. Associating a subdisk with a plex, for example, requires updating the subdisk with the volume contents before actually associating the subdisk. This update requires associating the subdisk with a temporary plex, marked TEMPRM, until the operation completes and removes the TEMPRM plex.

If the system fails for any reason, the TEMPRM state indicates that the operation did not complete successfully. A later operation dissociates and removes TEMPRM plexes.



TEMPRMSD Plex State

The TEMPRMSD plex state is used by `vxassist` when attaching new data plexes to a volume. If the synchronization operation does not complete, the plex and its subdisks are removed.

Plex Condition Flags

`vxprint` may also display one of the following condition flags in the STATE field:

IOFAIL Plex Condition

The plex was detached as a result of an I/O failure detected during normal volume I/O. The plex is out-of-date with respect to the volume, and in need of complete recovery. However, this condition also indicates a likelihood that one of the disks in the system should be replaced.

NODAREC Plex Condition

No physical disk was found for one of the subdisks in the plex. This implies either that the physical disk failed, making it unrecognizable, or that the physical disk is no longer attached through a known access path. The plex cannot be used until this condition is fixed, or the affected subdisk is dissociated.

NODEVICE Plex Condition

A physical device could not be found corresponding to the disk ID in the disk media record for one of the subdisks associated with the plex. The plex cannot be used until this condition is fixed, or the affected subdisk is dissociated.

RECOVER Plex Condition

A disk corresponding to one of the disk media records was replaced, or was reattached too late to prevent the plex from becoming out-of-date with respect to the volume. The plex required complete recovery from another plex in the volume to synchronize its contents.

REMOVED Plex Condition

Set in the disk media record when one of the subdisks associated with the plex is removed. The plex cannot be used until this condition is fixed, or the affected subdisk is dissociated.

Plex Kernel States

The *plex kernel state* indicates the accessibility of the plex to the volume driver which monitors it.

Note No user intervention is required to set these states; they are maintained internally. On a system that is operating properly, all plexes are enabled.

The following plex kernel states are defined:

DETACHED Plex Kernel State

Maintenance is being performed on the plex. Any write request to the volume is not reflected in the plex. A read request from the volume is not satisfied from the plex. Plex operations and `ioctl` function calls are accepted.

DISABLED Plex Kernel State

The plex is offline and cannot be accessed.

ENABLED Plex Kernel State

The plex is online. A write request to the volume is reflected in the plex. A read request from the volume is satisfied from the plex.

Attaching and Associating Plexes

A plex becomes a participating plex for a volume by attaching it to a volume. (Attaching a plex associates it with the volume and enables the plex for use.) To attach a plex to an existing volume, use the following command:

```
# vxplex [-g diskgroup] att volume plex
```

For example, to attach a plex named `vol01-02` to a volume named `vol01` in the disk group, `mydg`, use the following command:

```
# vxplex -g mydg att vol01 vol01-02
```

If the volume does not already exist, a plex (or multiple plexes) can be associated with the volume when it is created using the following command:

```
# vxmake [-g diskgroup] -U usetype vol volume plex=plex1[,plex2...]
```



For example, to create a mirrored, `fsngen`-type volume named `home`, and to associate two existing plexes named `home-1` and `home-2` with `home`, use the following command:

```
# vxmake -g mydg -U fsngen vol home plex=home-1,home-2
```

Note You can also use the command `vxassist mirror volume` to add a data plex as a mirror to an existing volume.

Taking Plexes Offline

Once a volume has been created and placed online (`ENABLED`), VxVM can temporarily disconnect plexes from the volume. This is useful, for example, when the hardware on which the plex resides needs repair or when a volume has been left unstartable and a source plex for the volume revive must be chosen manually.

Resolving a disk or system failure includes taking a volume offline and attaching and detaching its plexes. The two commands used to accomplish disk failure resolution are `vxmend` and `vxplex`.

To take a plex `OFFLINE` so that repair or maintenance can be performed on the physical disk containing subdisks of that plex, use the following command:

```
# vxmend [-g diskgroup] off plex
```

If a disk has a head crash, put all plexes that have associated subdisks on the affected disk `OFFLINE`. For example, if plexes `vol101-02` and `vol102-02` in the disk group, `mydg`, had subdisks on a drive to be repaired, use the following command to take these plexes offline:

```
# vxmend -g mydg off vol101-02 vol102-02
```

This command places `vol101-02` and `vol102-02` in the `OFFLINE` state, and they remain in that state until it is changed. The plexes are not automatically recovered on rebooting the system.

Detaching Plexes

To temporarily detach one data plex in a mirrored volume, use the following command:

```
# vxplex [-g diskgroup] det plex
```

For example, to temporarily detach a plex named `vol01-02` in the disk group, `mydg`, and place it in maintenance mode, use the following command:

```
# vxplex -g mydg det vol01-02
```

This command temporarily detaches the plex, but maintains the association between the plex and its volume. However, the plex is not used for I/O. A plex detached with the preceding command is recovered at system reboot. The plex state is set to `STALE`, so that if a `vxvol start` command is run on the appropriate volume (for example, on system reboot), the contents of the plex is recovered and made `ACTIVE`.

When the plex is ready to return as an active part of its volume, follow the procedures in the following section, “[Reattaching Plexes](#).”

Reattaching Plexes

When a disk has been repaired or replaced and is again ready for use, the plexes must be put back online (plex state set to `ACTIVE`). To set the plexes to `ACTIVE`, use one of the following procedures depending on the state of the volume.

- ◆ If the volume is currently `ENABLED`, use the following command to reattach the plex:

```
# vxplex [-g diskgroup] att volume plex ...
```

For example, for a plex named `vol01-02` on a volume named `vol01` in the disk group, `mydg`, use the following command:

```
# vxplex -g mydg att vol01 vol01-02
```

As when returning an `OFFLINE` plex to `ACTIVE`, this command starts to recover the contents of the plex and, after the revive is complete, sets the plex utility state to `ACTIVE`.

- ◆ If the volume is not in use (not `ENABLED`), use the following command to re-enable the plex for use:

```
# vxmend [-g diskgroup] on plex
```

For example, to re-enable a plex named `vol01-02` in the disk group, `mydg`, enter:

```
# vxmend -g mydg on vol01-02
```

In this case, the state of `vol01-02` is set to `STALE`. When the volume is next started, the data on the plex is revived from another plex, and incorporated into the volume with its state set to `ACTIVE`.



If the `vxinfo` command shows that the volume is unstartable (see “Listing Unstartable Volumes” in the section “Recovery from Hardware Failure” in the *VERITAS Volume Manager Troubleshooting Guide*), set one of the plexes to `CLEAN` using the following command:

```
# vxmend [-g diskgroup] fix clean plex
```

Start the volume using the following command:

```
# vxvol [-g diskgroup] start volume
```

Moving Plexes

Moving a plex copies the data content from the original plex onto a new plex. To move a plex, use the following command:

```
# vxplex [-g diskgroup] mv original_plex new_plex
```

For a move task to be successful, the following criteria must be met:

- ◆ The old plex must be an active part of an active (ENABLED) volume.
- ◆ The new plex must be at least the same size or larger than the old plex.
- ◆ The new plex must not be associated with another volume.

The size of the plex has several implications:

- ◆ If the new plex is smaller or more sparse than the original plex, an incomplete copy is made of the data on the original plex. If an incomplete copy is desired, use the `-o force` option to `vxplex`.
- ◆ If the new plex is longer or less sparse than the original plex, the data that exists on the original plex is copied onto the new plex. Any area that is not on the original plex, but is represented on the new plex, is filled from other complete plexes associated with the same volume.
- ◆ If the new plex is longer than the volume itself, then the remaining area of the new plex above the size of the volume is not initialized and remains unused.

Copying Plexes

This task copies the contents of a volume onto a specified plex. The volume to be copied must not be enabled. The plex cannot be associated with any other volume. To copy a plex, use the following command:

```
# vxplex [-g diskgroup] cp volume new_plex
```

After the copy task is complete, *new_plex* is not associated with the specified volume *volume*. The plex contains a complete copy of the volume data. The plex that is being copied should be the same size or larger than the volume. If the plex being copied is larger than the volume, an incomplete copy of the data results. For the same reason, *new_plex* should not be sparse.

Dissociating and Removing Plexes

When a plex is no longer needed, you can dissociate it from its volume and remove it as an object from VxVM. You might want to remove a plex for the following reasons:

- ◆ to provide free disk space
- ◆ to reduce the number of mirrors in a volume so you can increase the length of another mirror and its associated volume. When the plexes and subdisks are removed, the resulting space can be added to other volumes
- ◆ to remove a temporary mirror that was created to back up a volume and is no longer needed
- ◆ to change the layout of a plex

Caution To save the data on a plex to be removed, the configuration of that plex must be known. Parameters from that configuration (stripe unit size and subdisk ordering) are critical to the creation of a new plex to contain the same data. Before a plex is removed, you must record its configuration. See [“Displaying Plex Information”](#) on page 184 for more information.

To dissociate a plex from the associated volume and remove it as an object from VxVM, use the following command:

```
# vxplex [-g diskgroup] -o rm dis plex
```

For example, to dissociate and remove a plex named *vol01-02* in the disk group, *mydg*, use the following command:

```
# vxplex -g mydg -o rm dis vol01-02
```

This command removes the plex *vol01-02* and all associated subdisks.



Alternatively, you can first dissociate the plex and subdisks, and then remove them with the following commands:

```
# vxplex [-g diskgroup] dis plex
# vxedit [-g diskgroup] -r rm plex
```

When used together, these commands produce the same result as the `vxplex -o rm dis` command. The `-r` option to `vxedit rm` recursively removes all objects from the specified object downward. In this way, a plex and its associated subdisks can be removed by a single `vxedit` command.

Changing Plex Attributes

Caution Change plex attributes with extreme care.

The `vxedit` command changes the attributes of plexes and other volume Manager objects. To change plex attributes, use the following command:

```
# vxedit [-g diskgroup] set attribute=value ... plex
```

Plex fields that can be changed using the `vxedit` command include:

- ◆ name
- ◆ `putiln`
- ◆ `tutiln`
- ◆ comment

The `putiln` field attributes are maintained on reboot; `tutiln` fields are temporary and are not retained on reboot. VxVM sets the `putil0` and `tutil0` utility fields. Other VERITAS products, such as the VERITAS Enterprise Administrator (VEA), set the `putil1` and `tutil1` fields. The `putil2` and `tutil2` are available for you to use for site-specific purposes.

The following example command sets the comment field, and also sets `tutil2` to indicate that the subdisk is in use:

```
# vxedit -g mydg set comment="plex comment" tutil2="u" vol01-02
```

To prevent a particular plex from being associated with a volume, set the `putil0` field to a non-null string, as shown in the following command:

```
# vxedit -g mydg set putil0="DO-NOT-USE" vol01-02
```

See the `vxedit(1M)` manual page for more information about using the `vxedit` command to change the attribute fields of VxVM objects.

This chapter describes how to create *volumes* in VERITAS Volume Manager (VxVM). Volumes are logical devices that appear as physical disk partition devices to data management systems. Volumes enhance recovery from hardware failure, data availability, performance, and storage configuration.

Note You can also use the VERITAS Intelligent Storage Provisioning (ISP) feature to create and administer application volumes. These volumes are very similar to the traditional VxVM volumes that are described in this chapter. However, there are significant differences between the functionality of the two types of volume that prevents them from being used interchangeably. Refer to the *VERITAS Storage Foundation Intelligent Storage Provisioning Administrator's Guide* for more information about creating and administering ISP application volumes.

Volumes are created to take advantage of the VxVM concept of virtual disks. A file system can be placed on the volume to organize the disk space with files and directories. In addition, you can configure applications such as databases to organize data on volumes.

Note Disks and disk groups must be initialized and defined to VxVM before volumes can be created from them. See "[Administering Disks](#)" on page 59 and "[Creating and Administering Disk Groups](#)" on page 131 for more information.



Types of Volume Layouts

VxVM allows you to create volumes with the following layout types:

- ◆ **Concatenated**—A volume whose subdisks are arranged both sequentially and contiguously within a plex. Concatenation allows a volume to be created from multiple regions of one or more disks if there is not enough space for an entire volume on a single region of a disk. For more information, see [“Concatenation and Spanning”](#) on page 18.
- ◆ **Striped**—A volume with data spread evenly across multiple disks. *Stripes* are equal-sized fragments that are allocated alternately and evenly to the subdisks of a single plex. There must be at least two subdisks in a striped plex, each of which must exist on a different disk. Throughput increases with the number of disks across which a plex is striped. Striping helps to balance I/O load in cases where high traffic areas exist on certain subdisks. For more information, see [“Striping \(RAID-0\)”](#) on page 21.
- ◆ **Mirrored**—A volume with multiple data plexes that duplicate the information contained in a volume. Although a volume can have a single data plex, at least two are required for true mirroring to provide redundancy of data. For the redundancy to be useful, each of these data plexes should contain disk space from different disks. For more information, see [“Mirroring \(RAID-1\)”](#) on page 25.
- ◆ **RAID-5**—A volume that uses striping to spread data and parity evenly across multiple disks in an array. Each stripe contains a parity stripe unit and data stripe units. Parity can be used to reconstruct data if one of the disks fails. In comparison to the performance of striped volumes, write throughput of RAID-5 volumes decreases since parity information needs to be updated each time data is accessed. However, in comparison to mirroring, the use of parity to implement data redundancy reduces the amount of space required. For more information, see [“RAID-5 \(Striping with Parity\)”](#) on page 29.
- ◆ **Mirrored-stripe**—A volume that is configured as a striped plex and another plex that mirrors the striped one. This requires at least two disks for striping and one or more other disks for mirroring (depending on whether the plex is simple or striped). The advantages of this layout are increased performance by spreading data across multiple disks and redundancy of data. [“Striping Plus Mirroring \(Mirrored-Stripe or RAID-0+1\)”](#) on page 25.
- ◆ **Layered Volume**—A volume constructed from other volumes. Non-layered volumes are constructed by mapping their subdisks to VM disks. Layered volumes are constructed by mapping their subdisks to underlying volumes (known as *storage volumes*), and allow the creation of more complex forms of logical layout. Examples of layered volumes are *striped-mirror* and *concatenated-mirror* volumes. For more information, see [“Layered Volumes”](#) on page 34.

A striped-mirror volume is created by configuring several mirrored volumes as the columns of a striped volume. This layout offers the same benefits as a non-layered mirrored-stripe volume. In addition it provides faster recovery as the failure of single disk does not force an entire striped plex offline. For more information, see [“Mirroring Plus Striping \(Striped-Mirror, RAID-1+0 or RAID-10\)”](#) on page 26.

A concatenated-mirror volume is created by concatenating several mirrored volumes. This provides faster recovery as the failure of a single disk does not force the entire mirror offline.

Supported Volume Logs and Maps

VERITAS Volume Manager supports the use of several types of logs and maps with volumes:

- ◆ FastResync Maps are used to perform quick and efficient resynchronization of mirrors (see [“FastResync”](#) on page 49 for details). These maps are supported either in memory (Non-Persistent FastResync), or on disk as part of a DCO volume (Persistent FastResync). Two types of DCO volume are supported:
 - ◆ Version 0 DCO volumes only support Persistent FastResync for the traditional third-mirror break-off type of volume snapshot. See [“Version 0 DCO Volume Layout”](#) on page 51, and [“Creating a Volume with a Version 0 DCO Volume”](#) on page 210 for more information.
 - ◆ Version 20 DCO volumes, introduced in VxVM 4.0, support DRL logging (see below) and Persistent FastResync for full-sized and space-optimized instant volume snapshots. See [“Version 20 DCO Volume Layout”](#) on page 51, and [“Creating a Volume with a Version 20 DCO Volume”](#) on page 212 for more information.

See [“Enabling FastResync on a Volume”](#) on page 252 for information on how to enable Persistent or Non-Persistent FastResync on a volume.

- ◆ Dirty region logs allow the fast recovery of mirrored volumes after a system crash (see [“Dirty Region Logging \(DRL\)”](#) on page 42 for details). These logs are supported either as DRL log plexes, or as part of a version 20 DCO volume. Refer to the following sections for information on creating a volume on which DRL is enabled:
 - ◆ [“Creating a Volume with Dirty Region Logging Enabled”](#) on page 213 for creating a volume with DRL log plexes.
 - ◆ [“Creating a Volume with a Version 20 DCO Volume”](#) on page 212 for creating a volume with DRL configured within a version 20 DCO volume.
- ◆ RAID-5 logs are used to prevent corruption of data during recovery of RAID-5 volumes (see [“RAID-5 Logging”](#) on page 33 for details). These logs are configured as plexes on disks other than those that are used for the columns of the RAID-5 volume.



See [“Creating a RAID-5 Volume”](#) on page 217 for information on creating a RAID-5 volume together with RAID-5 logs.

Creating a Volume

You can create volumes using an *advanced* approach, an *assisted* approach, or the rule-based storage allocation approach that is provided by the Intelligent Storage Provisioning (ISP) feature. Each method uses different tools. You may switch between the advanced and the assisted approaches at will. However, volumes that you have created using ISP may only be modified using ISP-specific tools such as `vxvoladm`. For more information about ISP, see the *VERITAS Storage Foundation Intelligent Storage Provisioning Administrator’s Guide*.

Note Most VxVM commands require superuser or equivalent privileges.

Advanced Approach

The advanced approach consists of a number of commands that typically require you to specify detailed input. These commands use a “building block” approach that requires you to have a detailed knowledge of the underlying structure and components to manually perform the commands necessary to accomplish a certain task. Advanced operations are performed using several different VxVM commands.

The steps to create a volume using this approach are:

1. Create subdisks using `vxmake sd`; see [“Creating Subdisks”](#) on page 175.
2. Create plexes using `vxmake plex`, and associate subdisks with them; see [“Creating Plexes”](#) on page 183, [“Associating Subdisks with Plexes”](#) on page 178 and [“Creating a Volume Using vxmake”](#) on page 218.
3. Associate plexes with the volume using `vxmake vol`; see [“Creating a Volume Using vxmake”](#) on page 218.
4. Initialize the volume using `vxvol start` or `vxvol init zero`; see [“Initializing and Starting a Volume Created Using vxmake”](#) on page 222.

See [“Creating a Volume Using a vxmake Description File”](#) on page 220 for an example of how you can combine steps 1 through 3 using a volume description file with `vxmake`.

See [“Creating a Volume Using vxmake”](#) on page 218 for an example of how to perform steps 2 and 3 to create a RAID-5 volume.



Assisted Approach

The assisted approach takes information about what you want to accomplish and then performs the necessary underlying tasks. This approach requires only minimal input from you, but also permits more detailed specifications.

Assisted operations are performed primarily through the `vxassist` command or the VERITAS Enterprise Administrator (VEA). `vxassist` and the VEA create the required plexes and subdisks using only the basic attributes of the desired volume as input. Additionally, they can modify existing volumes while automatically modifying any underlying or associated objects.

Both `vxassist` and the VEA use default values for many volume attributes, unless you provide specific values. They do not require you to have a thorough understanding of low-level VxVM concepts, `vxassist` and the VEA do not conflict with other VxVM commands or preclude their use. Objects created by `vxassist` and the VEA are compatible and inter-operable with objects created by other VxVM commands and interfaces.

For more information about the VEA, see the *VERITAS Enterprise Administrator Getting Started* manual and VEA online help.

Using vxassist

You can use the `vxassist` utility to create and modify volumes. Specify the basic requirements for volume creation or modification, and `vxassist` performs the necessary tasks.

The advantages of using `vxassist` rather than the advanced approach include:

- ◆ Most actions require that you enter only one command rather than several.
- ◆ You are required to specify only minimal information to `vxassist`. If necessary, you can specify additional parameters to modify or control its actions.
- ◆ Operations result in a set of configuration changes that either succeed or fail as a group, rather than individually. System crashes or other interruptions do not leave intermediate states that you have to clean up. If `vxassist` finds an error or an exceptional condition, it exits after leaving the system in the same state as it was prior to the attempted operation.



The `vxassist` utility helps you perform the following tasks:

- ◆ Creating volumes.
- ◆ Creating mirrors for existing volumes.
- ◆ Growing or shrinking existing volumes.
- ◆ Backing up volumes online.
- ◆ Reconfiguring a volume's layout online.

`vxassist` obtains most of the information it needs from sources other than your input. `vxassist` obtains information about the existing objects and their layouts from the objects themselves.

For tasks requiring new disk space, `vxassist` seeks out available disk space and allocates it in the configuration that conforms to the layout specifications and that offers the best use of free space.

The `vxassist` command takes this form:

```
# vxassist [options] keyword volume [attributes...]
```

where *keyword* selects the task to perform. The first argument after a `vxassist` keyword, *volume*, is a volume name, which is followed by a set of desired volume attributes. For example, the keyword `make` allows you to create a new volume:

```
# vxassist [options] make volume length [attributes]
```

The *length* of the volume can be specified in sectors, kilobytes, megabytes, or gigabytes using a suffix character of *s*, *k*, *m*, or *g*. If no suffix is specified, the size is assumed to be in sectors. See the `vxintro(1M)` manual page for more information on specifying units.

Additional attributes can be specified as appropriate, depending on the characteristics that you wish the volume to have. Examples are stripe unit width, number of columns in a RAID-5 or stripe volume, number of mirrors, number of logs, and log type.

Note By default, the `vxassist` command creates volumes in a default disk group according to the rules given in [“Rules for Determining the Default Disk Group”](#) on page 133. To use a different disk group, specify the `-g diskgroup` option to `vxassist`.

For details of available `vxassist` keywords and attributes, refer to the `vxassist(1M)` manual page.

The section, [“Creating a Volume on Any Disk”](#) on page 203 describes the simplest way to create a volume with default attributes. Later sections describe how to create volumes with specific attributes. For example, [“Creating a Volume on Specific Disks”](#) on page 203 describes how to control how `vxassist` uses the available storage space.

Setting Default Values for vxassist

The default values that the `vxassist` command uses may be specified in the file `/etc/default/vxassist`. The defaults listed in this file take effect if you do not override them on the command line, or in an alternate defaults file that you specify using the `-d` option. A default value specified on the command line always takes precedence. `vxassist` also has a set of built-in defaults that it uses if it cannot find a value defined elsewhere.

Note You must create the `/etc/default` directory and the `vxassist` default file if these do not already exist on your system.

The format of entries in a defaults file is a list of attribute-value pairs separated by new lines. These attribute-value pairs are the same as those specified as options on the `vxassist` command line. Refer to the `vxassist(1M)` manual page for details.

To display the default attributes held in the file `/etc/default/vxassist`, use the following form of the `vxassist` command:

```
# vxassist help showattrs
```

The following is a sample `vxassist` defaults file:

```
# By default:
# create unmirrored, unstriped volumes
# allow allocations to span drives
# with RAID-5 create a log, with mirroring don't create a log
# align allocations on cylinder boundaries
  layout=nomirror,nostripe,span,nocontig,raid5log,noregionlog,
  diskalign
# use the fsgen usage type, except when creating RAID-5 volumes
  usetype=fsgen
# allow only root access to a volume
  mode=u=rw,g=,o=
  user=root
  group=root
# when mirroring, create two mirrors
  nmirror=2
# for regular striping, by default create between 2 and 8 stripe
# columns
  max_nstripe=8
  min_nstripe=2
# for RAID-5, by default create between 3 and 8 stripe columns
  max_nraid5stripe=8
  min_nraid5stripe=3
```



```
# by default, create 1 log copy for both mirroring and RAID-5 volumes
nregionlog=1
nraid5log=1

# by default, limit mirroring log lengths to 32Kbytes
max_regionloglen=32k

# use 64K as the default stripe unit size for regular volumes
stripe_stwid=64k

# use 16K as the default stripe unit size for RAID-5 volumes
raid5_stwid=16k
```

Discovering the Maximum Size of a Volume

To find out how large a volume you can create within a disk group, use the following form of the `vxassist` command:

```
# vxassist [-g diskgroup] maxsize layout=layout [attributes]
```

For example, to discover the maximum size RAID-5 volume with 5 columns and 2 logs that you can create within the disk group, `dgrp`, enter the following command:

```
# vxassist -g dgrp maxsize layout=raid5 nlog=2
```

You can use storage attributes if you want to restrict the disks that `vxassist` uses when creating volumes. See “[Creating a Volume on Specific Disks](#)” on page 203 for more information.

Disk Group Alignment Constraints on Volumes

Certain constraints apply to the length of volumes and to the numeric values of size attributes that apply to volumes. If a volume is created in a disk group that is compatible with the Cross-platform Data Sharing (CDS) feature, the volume’s length and the values of volume attributes that define the sizes of objects such as logs or stripe units, must be an integer multiple of the alignment value of 8 blocks (8 kilobytes). If the disk group is not compatible with the CDS feature, the volume’s length and attribute size values must be multiples of 1 block (1kilobyte).

To discover the value in blocks of the alignment that is set on a disk group, use this command:

```
# vxprint -g diskgroup -G -F %align
```

By default, `vxassist` automatically rounds up the volume size and attribute size values to a multiple of the alignment value. (This is equivalent to specifying the attribute `dgaligned_checking=round` as an additional argument to the `vxassist` command.)

If you specify the attribute `dgalign_checking=strict` to `vxassist`, the command fails with an error if you specify a volume length or attribute size value that is not a multiple of the alignment value for the disk group.

Creating a Volume on Any Disk

By default, the `vxassist make` command creates a concatenated volume that uses one or more sections of disk space. On a fragmented disk, this allows you to put together a volume larger than any individual section of free disk space available.

Note To change the default layout, edit the definition of the `layout` attribute defined in the `/etc/default/vxassist` file.

If there is not enough space on a single disk, `vxassist` creates a spanned volume. A spanned volume is a concatenated volume with sections of disk space spread across more than one disk. A spanned volume can be larger than any disk on a system, since it takes space from more than one disk.

To create a concatenated, default volume, use the following form of the `vxassist` command:

```
# vxassist [-b] [-g diskgroup] make volume length
```

Note Specify the `-b` option if you want to make the volume immediately available for use. See “[Initializing and Starting a Volume](#)” on page 221 for details.

For example, to create the concatenated volume `voldefault` with a length of 10 gigabytes in the default disk group:

```
# vxassist -b make voldefault 10g
```

Creating a Volume on Specific Disks

VxVM automatically selects the disks on which each volume resides, unless you specify otherwise. If you want a volume to be created on specific disks, you must designate those disks to VxVM. More than one disk can be specified.

To create a volume on a specific disk or disks, use the following command:

```
# vxassist [-b] [-g diskgroup] make volume length [layout=layout] \  
  diskname ...
```

For example, to create the volume `volspec` with length 5 gigabytes on disks `mydg03` and `mydg04`, use the following command:

```
# vxassist -b -g mydg make volspec 5g mydg03 mydg04
```



The `vxassist` command allows you to specify storage attributes. These give you control over the devices, including disks, controllers and targets, which `vxassist` uses to configure a volume. For example, you can specifically exclude disk `mydg05`:

```
# vxassist -b -g mydg make volspec 5g !mydg05
```

or exclude all disks that are on controller `c2`:

```
# vxassist -b -g mydg make volspec 5g !ctrl:c2
```

or include only disks on controller `c1` except for target `t5`:

```
# vxassist -b -g mydg make volspec 5g ctrl:c1 !target:c1t5
```

If you want a volume to be created using only disks from a specific disk group, use the `-g` option to `vxassist`, for example:

```
# vxassist -g bigone -b make volmega 20g bigone10 bigone11
```

or alternatively, use the `diskgroup` attribute:

```
# vxassist -b make volmega 20g diskgroup=bigone bigone10 bigone11
```

Note Any storage attributes that you specify for use must belong to the disk group. Otherwise, `vxassist` will not use them to create a volume.

You can also use storage attributes to control how `vxassist` uses available storage, for example, when calculating the maximum size of a volume, when growing a volume or when removing mirrors or logs from a volume. The following example excludes disks `dgrp07` and `dgrp08` when calculating the maximum size of RAID-5 volume that `vxassist` can create using the disks in the disk group `dg`:

```
# vxassist -b -g dgrp maxsize layout=raid5 nlog=2 !dgrp07 !dgrp08
```

See the `vxassist(1M)` manual page for more information about using storage attributes. It is also possible to control how volumes are laid out on the specified storage as described in the next section "[Specifying Ordered Allocation of Storage to Volumes.](#)"

Specifying Ordered Allocation of Storage to Volumes

Ordered allocation gives you complete control of space allocation. It requires that the number of disks that you specify to the `vxassist` command must match the number of disks that are required to create a volume. The order in which you specify the disks to `vxassist` is also significant.

If you specify the `-o ordered` option to `vxassist` when creating a volume, any storage that you also specify is allocated in the following order:

1. Concatenate disks.
2. Form columns.
3. Form mirrors.

For example, the following command creates a mirrored-stripe volume with 3 columns and 2 mirrors on 6 disks in the disk group, `mydg`:

```
# vxassist -b -g mydg -o ordered make mirstrvol 10g \  
  layout=mirror-stripe ncol=3 \  
  mydg01 mydg02 mydg03 mydg04 mydg05 mydg06
```

This command places columns 1, 2 and 3 of the first mirror on disks `mydg01`, `mydg02` and `mydg03` respectively, and columns 1, 2 and 3 of the second mirror on disks `mydg04`, `mydg05` and `mydg06` respectively. This arrangement is illustrated in “[Example of Using Ordered Allocation to Create a Mirrored-Stripe Volume.](#)”

Example of Using Ordered Allocation to Create a Mirrored-Stripe Volume

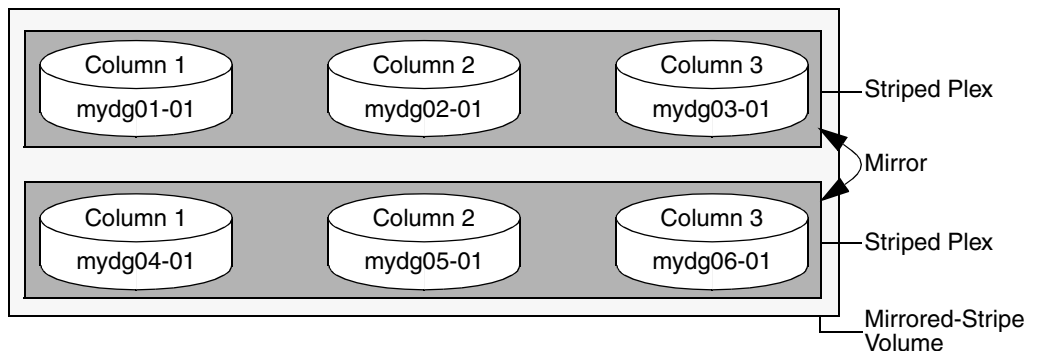

For layered volumes, `vxassist` applies the same rules to allocate storage as for non-layered volumes. For example, the following command creates a striped-mirror volume with 2 columns:

```
# vxassist -b -g mydg -o ordered make strmirvol 10g \
  layout=stripe-mirror ncol=2 mydg01 mydg02 mydg03 mydg04
```

This command mirrors column 1 across disks `mydg01` and `mydg03`, and column 2 across disks `mydg02` and `mydg04`, as illustrated in “[Example of Using Ordered Allocation to Create a Striped-Mirror Volume](#).”

Example of Using Ordered Allocation to Create a Striped-Mirror Volume

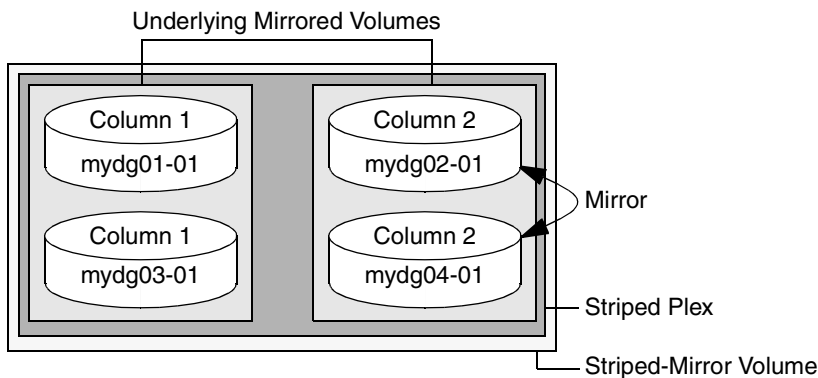

Additionally, you can use the `col_switch` attribute to specify how to concatenate space on the disks into columns. For example, the following command creates a mirrored-stripe volume with 2 columns:

```
# vxassist -b -g mydg -o ordered make strmir2vol 10g \
  layout=mirror-stripe ncol=2 col_switch=3g,2g \
  mydg01 mydg02 mydg03 mydg04 mydg05 mydg06 mydg07 mydg08
```

This command allocates 3 gigabytes from `mydg01` and 2 gigabytes from `mydg02` to column 1, and 3 gigabytes from `mydg03` and 2 gigabytes from `mydg04` to column 2. The mirrors of these columns are then similarly formed from disks `mydg05` through `mydg08`. This arrangement is illustrated in “[Example of Using Concatenated Disk Space to Create a Mirrored-Stripe Volume](#)” on page 207.

Example of Using Concatenated Disk Space to Create a Mirrored-Stripe Volume

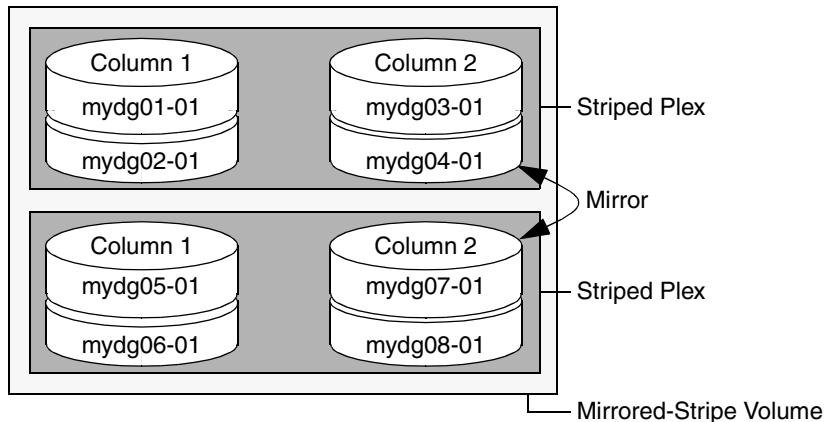

Other storage specification classes for controllers, enclosures, targets and trays can be used with ordered allocation. For example, the following command creates a 3-column mirrored-stripe volume between specified controllers:

```
# vxassist -b -g mydg -o ordered make mirstr2vol 80g \
  layout=mirror-stripe ncol=3 \
  ctrlr:c1 ctrlr:c2 ctrlr:c3 ctrlr:c4 ctrlr:c5 ctrlr:c6
```

This command allocates space for column 1 from disks on controllers `c1`, for column 2 from disks on controller `c2`, and so on as illustrated in [“Example of Storage Allocation Used to Create a Mirrored-Stripe Volume Across Controllers”](#) on page 208.



Example of Storage Allocation Used to Create a Mirrored-Stripe Volume Across Controllers

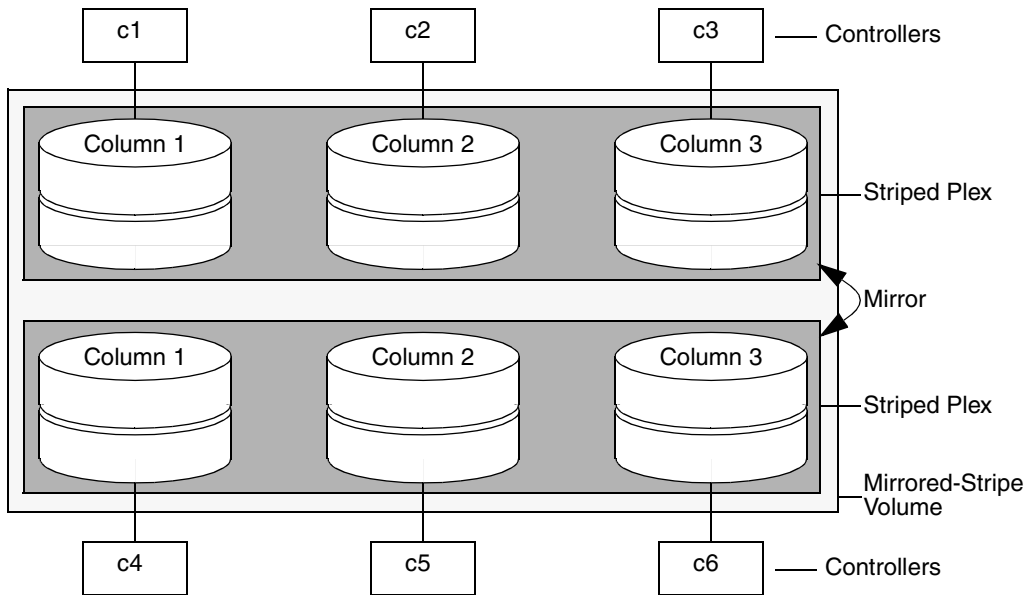

For other ways in which you can control how vxassist lays out mirrored volumes across controllers, see [“Mirroring across Targets, Controllers or Enclosures”](#) on page 216.

Creating a Mirrored Volume

A mirrored volume provides data redundancy by containing more than one copy of its data. Each copy (or mirror) is stored on different disks from the original copy of the volume and from other mirrors. Mirroring a volume ensures that its data is not lost if a disk in one of its component mirrors fails.

Note A mirrored volume requires space to be available on at least as many disks in the disk group as the number of mirrors in the volume.

To create a new mirrored volume, use the following command:

```
# vxassist [-b] [-g diskgroup] make volume length layout=mirror \
  [nmirror=number] [init=active]
```

For example, to create the mirrored volume, `volmir`, in the disk group, `mydg`, use the following command:

```
# vxassist -b -g mydg make volmir 5g layout=mirror
```

To create a volume with 3 instead of the default of 2 mirrors, modify the command to read:

```
# vxassist -b -g mydg make volmir 5g layout=mirror nmirror=3
```

Creating a Mirrored-Concatenated Volume

A mirrored-concatenated volume mirrors several concatenated plexes. To create a concatenated-mirror volume, use the following command:

```
# vxassist [-b] [-g diskgroup] make volume length \
  layout=mirror-concat [nmirror=number]
```

Alternatively, first create a concatenated volume, and then mirror it as described in [“Adding a Mirror to a Volume”](#) on page 231.

Creating a Concatenated-Mirror Volume

Note You need a full license to use this feature.

A concatenated-mirror volume is an example of a layered volume which concatenates several underlying mirror volumes. To create a concatenated-mirror volume, use the following command:

```
# vxassist [-b] [-g diskgroup] make volume length \
  layout=concat-mirror [nmirror=number]
```



Creating a Volume with a Version 0 DCO Volume

If a data change object (DCO) and DCO volume are associated with a volume, this allows Persistent FastResync to be used with the volume. (See [“How Persistent FastResync Works with Snapshots”](#) on page 53 for details of how Persistent FastResync performs fast resynchronization of snapshot mirrors when they are returned to their original volume.)

Note The procedure described in this section creates a volume with a data change object (DCO) and DCO volume that has a version 0 layout as introduced in VxVM 3.2. The version 0 layout supports traditional (third-mirror) snapshots, but not full-sized instant snapshots, space-optimized instant snapshots nor DRL configured within the DCO volume. See [“Version 0 DCO Volume Layout”](#) on page 51 and [“Version 20 DCO Volume Layout”](#) on page 51 for a description of the differences between the old and new DCO volume layouts.

For details of how to configure a volume with a version 20 DCO and DCO volume, see [“Creating a Volume with a Version 20 DCO Volume”](#) on page 212. This is the preferred and recommended method.

See [“Determining the DCO Version Number”](#) on page 238 for details of how to determine the version number of a volume’s DCO.

To perform fast resynchronization of mirrors after a system crash or reboot, you must also enable dirty region logging (DRL) on a mirrored volume. To add a DCO object and DCO volume to a volume on which DRL logging is enabled, follow the procedure described in [“Adding a Version 0 DCO and DCO Volume”](#) on page 307.

Note You need a VERITAS FlashSnap™ or FastResync license to use the Persistent FastResync feature. Even if you do not have a license, you can configure a DCO object and DCO volume so that snap objects are associated with the original and snapshot volumes. For more information about snap objects, see [“How Persistent FastResync Works with Snapshots”](#) on page 53.

To create a volume with an attached version 0 DCO object and volume, use the following procedure:

1. Ensure that the disk group has been upgraded to version 90. Use the following command to check the version of a disk group:

```
# vxkg list diskgroup
```

To upgrade a disk group to version 90, use the following command:

```
# vxkg -T 90 upgrade diskgroup
```

For more information, see [“Upgrading a Disk Group”](#) on page 169.

2. Use the following command to create the volume (you may need to specify additional attributes to create a volume with the desired characteristics):

```
# vxassist [-g diskgroup] make volume length layout=layout \
  logtype=dco [ndcomirror=number] [dcolen=size] [fastresync=on] \
  [other attributes]
```

For non-layered volumes, the default number of plexes in the mirrored DCO volume is equal to the lesser of the number of plexes in the data volume or 2. For layered volumes, the default number of DCO plexes is always 2. If required, use the `ndcomirror` attribute to specify a different *number*. It is recommended that you configure as many DCO plexes as there are data plexes in the volume. For example, specify `ndcomirror=3` when creating a 3-way mirrored volume.

The default size of each plex is 132 blocks unless you use the `dcolen` attribute to specify a different *size*. If specified, the size of the plex must be a multiple of 33 blocks from 33 up to a maximum of 2112 blocks.

By default, FastResync is not enabled on newly created volumes. Specify the `fastresync=on` attribute if you want to enable FastResync on the volume. If a DCO object and DCO volume are associated with the volume, Persistent FastResync is enabled; otherwise, Non-Persistent FastResync is enabled.

3. To enable DRL or sequential DRL logging on the newly created volume, use the following command:

```
# vxvol [-g diskgroup] set logtype=drl|drlseq volume
```

For more information, see the `vxassist(1M)` and `vxvol(1M)` manual pages.

If you use ordered allocation when creating a mirrored volume on specified storage, you can use the optional `logdisk` attribute to specify on which disks dedicated log plexes should be created. Use the following form of the `vxassist` command to specify the disks from which space for the logs is to be allocated:

```
# vxassist [-g diskgroup] -o ordered make volume length \
  layout=mirror logtype=log_type logdisk=disk[,disk,...] \
  storage_attributes
```

If you do not specify the `logdisk` attribute, `vxassist` locates the logs in the data plexes of the volume.

For more information about ordered allocation, see [“Specifying Ordered Allocation of Storage to Volumes”](#) on page 205 and the `vxassist(1M)` manual page.



Creating a Volume with a Version 20 DCO Volume

To create a volume with an attached version 20 DCO object and volume, use the following procedure:

1. Ensure that the disk group has been upgraded to the latest version. Use the following command to check the version of a disk group:

```
# vxvg list diskgroup
```

To upgrade a disk group to the most recent version, use the following command:

```
# vxvg upgrade diskgroup
```

For more information, see [“Upgrading a Disk Group”](#) on page 169.

2. Use the following command to create the volume (you may need to specify additional attributes to create a volume with the desired characteristics):

```
# vxassist [-g diskgroup] make volume length layout=layout \  
logtype=dco dcoverion=20 [drl=on|sequential|off] \  
[ndcomirror=number] [fastresync=on] [other attributes]
```

Set the value of the `drl` attribute to `on` if dirty region logging (DRL) is to be used with the volume (this is the default setting). For a volume that will be written to sequentially, such as a database log volume, set the value to `sequential` to enable sequential DRL. The DRL logs are created in the DCO volume. The redundancy of the logs is determined by the number of mirrors that you specify using the `ndcomirror` attribute.

By default, Persistent FastResync is not enabled on newly created volumes. Specify the `fastresync=on` attribute if you want to enable Persistent FastResync on the volume.

For more information, see the `vxassist(1M)` manual page.

Note See [“Determining the DCO Version Number”](#) on page 238 for details of how to determine the version number of a volume’s DCO.



Creating a Volume with Dirty Region Logging Enabled

Note The procedure in this section is applicable to volumes that are created in disk groups with a version number of less than 110. To enable DRL or sequential DRL on a volume that is created within a disk group with a version number of 110 or greater, follow the procedure described in [“Creating a Volume with a Version 20 DCO Volume”](#) on page 212, which creates the DRL logs within the plexes of a version 20 DCO volume.

Dirty region logging (DRL), if enabled, speeds recovery of mirrored volumes after a system crash. To enable DRL on a volume that is created within a disk group with a version number between 20 and 100, specify the `logtype=dr1` attribute to the `vxassist make` command as shown in this example usage:

```
# vxassist [-g diskgroup] make volume length layout=layout \
  logtype=dr1 [nlog=n] [loglen=size] [other attributes]
```

The `nlog` attribute can be used to specify the number of log plexes to add. By default, one log plex is added. The `loglen` attribute specifies the size of the log, where each bit represents one region in the volume. For example, the size of the log would need to be 20K for a 10GB volume with a region size of 64 kilobytes.

For example, to create a mirrored 10GB volume, `vol02`, with two log plexes in the disk group, `mydg`, use the following command:

```
# vxassist -g mydg make vol02 10g layout=mirror logtype=dr1 \
  nlog=2 nmirror=2
```

Sequential DRL limits the number of dirty regions for volumes that are written to sequentially, such as database replay logs. To enable sequential DRL on a volume that is created within a disk group with a version number between 70 and 100, specify the `logtype=dr1seq` attribute to the `vxassist make` command.

```
# vxassist [-g diskgroup] make volume length layout=layout \
  logtype=dr1seq [nlog=n] [other attributes]
```

Note If you also want to allow the use of Persistent FastResync with the volume, use the procedure described in [“Creating a Volume with a Version 0 DCO Volume”](#) on page 210.



Creating a Striped Volume

Note You need a full license to use this feature.

A striped volume contains at least one plex that consists of two or more subdisks located on two or more physical disks. For more information on striping, see “[Striping \(RAID-0\)](#)” on page 21.

Note A striped volume requires space to be available on at least as many disks in the disk group as the number of columns in the volume.

To create a striped volume, use the following command:

```
# vxassist [-b] [-g diskgroup] make volume length layout=stripe
```

For example, to create the 10-gigabyte striped volume `volzebra`, in the disk group, `mydg`, use the following command:

```
# vxassist -b -g mydg make volzebra 10g layout=stripe
```

This creates a striped volume with the default stripe unit size (64 kilobytes) and the default number of stripes (2).

You can specify the disks on which the volumes are to be created by including the disk names on the command line. For example, to create a 30-gigabyte striped volume on three specific disks, `mydg03`, `mydg04`, and `mydg05`, use the following command:

```
# vxassist -b -g mydg make stripevol 30g layout=stripe \  
mydg03 mydg04 mydg05
```

To change the number of columns or the stripe width, use the `ncolumn` and `stripeunit` modifiers with `vxassist`. For example, the following command creates a striped volume with 5 columns and a 32-kilobyte stripe size:

```
# vxassist -b -g mydg make stripevol 30g layout=stripe \  
stripeunit=32k ncol=5
```

Creating a Mirrored-Stripe Volume

A mirrored-stripe volume mirrors several striped data plexes.

Note A mirrored-stripe volume requires space to be available on at least as many disks in the disk group as the number of mirrors multiplied by the number of columns in the volume.

To create a striped-mirror volume, use the following command:

```
# vxassist [-b] [-g diskgroup] make volume length \
  layout=mirror-stripe [nmirror=number mirrors] \
  [ncol=number_of_columns] [stripewidth=size]
```

Alternatively, first create a striped volume, and then mirror it as described in “[Adding a Mirror to a Volume](#)” on page 231. In this case, the additional data plexes may be either striped or concatenated.

Creating a Striped-Mirror Volume

A striped-mirror volume is an example of a layered volume which stripes several underlying mirror volumes.

Note A striped-mirror volume requires space to be available on at least as many disks in the disk group as the number of columns multiplied by the number of stripes in the volume.

To create a striped-mirror volume, use the following command:

```
# vxassist [-b] [-g diskgroup] make volume length \
  layout=stripe-mirror [nmirror=number mirrors] \
  [ncol=number_of_columns] [stripewidth=size]
```

By default, VxVM attempts to create the underlying volumes by mirroring subdisks rather than columns if the size of each column is greater than the value for the attribute `stripe-mirror-col-split-trigger-pt` that is defined in the `vxassist` defaults file.

If there are multiple subdisks per column, you can choose to mirror each subdisk individually instead of each column. To mirror at the subdisk level, specify the layout as `stripe-mirror-sd` rather than `stripe-mirror`. To mirror at the column level, specify the layout as `stripe-mirror-col` rather than `stripe-mirror`.



Mirroring across Targets, Controllers or Enclosures

To create a volume whose mirrored data plexes lie on different controllers (also known as *disk duplexing*) or in different enclosures, use the `vxassist` command as described in this section.

In the following command, the attribute `mirror=target` specifies that volumes should be mirrored between identical target IDs on different controllers.

```
# vxassist [-b] [-g diskgroup] make volume length layout=layout \  
mirror=target [attributes]
```

The attribute `mirror=ctlr` specifies that disks in one mirror should not be on the same controller as disks in other mirrors within the same volume:

```
# vxassist [-b] [-g diskgroup] make volume length layout=layout \  
mirror=ctlr [attributes]
```

Note Both paths of an active/passive array are not considered to be on different controllers when mirroring across controllers.

The following command creates a mirrored volume with two data plexes in the disk group, `mydg`:

```
# vxassist -b -g mydg make volspec 10g layout=mirror nmirror=2 \  
mirror=ctlr ctlr:c2 ctlr:c3
```

The disks in one data plex are all attached to controller `c2`, and the disks in the other data plex are all attached to controller `c3`. This arrangement ensures continued availability of the volume should either controller fail.

The attribute `mirror=enclr` specifies that disks in one mirror should not be in the same enclosure as disks in other mirrors within the same volume.

The following command creates a mirrored volume with two data plexes:

```
# vxassist -b make -g mydg volspec 10g layout=mirror nmirror=2 \  
mirror=enclr enclr:enc1 enclr:enc2
```

The disks in one data plex are all taken from enclosure `enc1`, and the disks in the other data plex are all taken from enclosure `enc2`. This arrangement ensures continued availability of the volume should either enclosure become unavailable.

See [“Specifying Ordered Allocation of Storage to Volumes”](#) on page 205 for a description of other ways in which you can control how volumes are laid out on the specified storage.

Creating a RAID-5 Volume

Note VxVM supports this feature for private disk groups, but not for shareable disk groups in a cluster environment.

Note You need a full license to use this feature.

You can create RAID-5 volumes by using either the `vxassist` command (recommended) or the `vxmake` command. Both approaches are described below.

Note A RAID-5 volume requires space to be available on at least as many disks in the disk group as the number of columns in the volume. Additional disks may be required for any RAID-5 logs that are created.

A RAID-5 volume contains a RAID-5 data plex that consists of three or more subdisks located on three or more physical disks. Only one RAID-5 data plex can exist per volume. A RAID-5 volume can also contain one or more RAID-5 log plexes, which are used to log information about data and parity being written to the volume. For more information on RAID-5 volumes, see [“RAID-5 \(Striping with Parity\)”](#) on page 29.

Caution Do not create a RAID-5 volume with more than 8 columns because the volume will be unrecoverable in the event of the failure of more than one disk.

To create a RAID-5 volume, use the following command:

```
# vxassist [-b] [-g diskgroup] make volume length layout=raid5 \
  [ncol=number_of_columns] [stripewidth=size] [nlog=number] \
  [loglen=log_length]
```

For example, to create the RAID-5 volume `volraid` together with 2 RAID-5 logs in the disk group, `mydg`, use the following command:

```
# vxassist -b -g mydg make volraid 10g layout=raid5 nlog=2
```

This creates a RAID-5 volume with the default stripe unit size on the default number of disks. It also creates two RAID-5 logs rather than the default of one log.

Note If you require RAID-5 logs, you must use the `logdisk` attribute to specify the disks to be used for the log plexes.

RAID-5 logs can be concatenated or striped plexes, and each RAID-5 log associated with a RAID-5 volume has a complete copy of the logging information for the volume. To support concurrent access to the RAID-5 array, the log should be several times the stripe size of the RAID-5 plex.



It is suggested that you configure a minimum of two RAID-5 log plexes for each RAID-5 volume. These log plexes should be located on different disks. Having two RAID-5 log plexes for each RAID-5 volume protects against the loss of logging information due to the failure of a single disk.

If you use ordered allocation when creating a RAID-5 volume on specified storage, you must use the `logdisk` attribute to specify on which disks the RAID-5 log plexes should be created. Use the following form of the `vxassist` command to specify the disks from which space for the logs is to be allocated:

```
# vxassist [-b] [-g diskgroup] -o ordered make volume length \  
  layout=raid5 [ncol=number_columns] [nlog=number] \  
  [loglen=log_length] logdisk=disk[, disk, ...] storage_attributes
```

For example, the following command creates a 3-column RAID-5 volume with the default stripe unit size on disks `mydg04`, `mydg05` and `mydg06`. It also creates two RAID-5 logs on disks `mydg07` and `mydg08`.

```
# vxassist -b -g mydg -o ordered make volraid 10g layout=raid5 \  
  ncol=3 nlog=2 logdisk=mydg07,mydg08 mydg04 mydg05 mydg06
```

Note The number of logs must equal the number of disks specified to `logdisk`.

For more information about ordered allocation, see “[Specifying Ordered Allocation of Storage to Volumes](#)” on page 205 and the `vxassist(1M)` manual page.

If you need to add more logs to a RAID-5 volume at a later date, follow the procedure described in “[Adding a RAID-5 Log](#)” on page 243.

Creating a Volume Using vxmake

As an alternative to using `vxassist`, you can create a volume using the `vxmake` command to arrange existing subdisks into plexes, and then to form these plexes into a volume. Subdisks can be created using the method described in “[Creating Subdisks](#)” on page 175. The example given in this section is to create a RAID-5 volume using `vxmake`.

Creating a RAID-5 plex for a RAID-5 volume is similar to creating striped plexes, except that the `layout` attribute is set to `raid5`. Subdisks can be implicitly associated in the same way as with striped plexes. For example, to create a four-column RAID-5 plex with a stripe unit size of 32 sectors, use the following command:

```
# vxmake -g mydg plex raidplex layout=raid5 stwidth=32 \  
  sd=mydg00-01,mydg01-00,mydg02-00,mydg03-00
```

Note that because four subdisks are specified, but the number of columns is not specified, the `vxmake` command assumes a four-column RAID-5 plex and places one subdisk in each column. Striped plexes are created using the same method except that the layout is specified as `stripe`. If the subdisks are to be created and added later, use the following command to create the plex:

```
# vxmake -g mydg plex raidplex layout=raid5 ncolumn=4 stwidth=32
```

Note If no subdisks are specified, the `ncolumn` attribute must be specified. Subdisks can be added to the plex later using the `vxsd assoc` command (see [“Associating Subdisks with Plexes”](#) on page 178).

If each column in a RAID-5 plex is to be created from multiple subdisks which may span several physical disks, you can specify to which column each subdisk should be added. For example, to create a three-column RAID-5 plex using six subdisks, use the following form of the `vxmake` command:

```
# vxmake -g mydg plex raidplex layout=raid5 stwidth=32 \
sd=mydg00-00:0,mydg01-00:1,mydg02-00:2,mydg03-00:0, \
mydg04-00:1,mydg05-00:2
```

This command stacks subdisks `mydg00-00` and `mydg03-00` consecutively in column 0, subdisks `mydg01-00` and `mydg04-00` consecutively in column 1, and subdisks `mydg02-00` and `mydg05-00` in column 2. Offsets can also be specified to create sparse RAID-5 plexes, as for striped plexes.

Log plexes may be created as default concatenated plexes by not specifying a layout, for example:

```
# vxmake -g mydg plex raidlog1 mydg06-00
# vxmake -g mydg plex raidlog2 mydg07-00
```

To create a RAID-5 volume, specify the usage type to be RAID-5 using the following command:

```
# vxmake -g mydg -Uraid5 vol raidvol
```

RAID-5 plexes and RAID-5 log plexes are associated with the volume `raidvol` using the following command:

```
# vxmake -g mydg -Uraid5 vol raidvol \
plex=raidplex,raidlog1,raidlog2
```

Note Each RAID-5 volume has one RAID-5 plex where the data and parity are stored. Any other plexes associated with the volume are used as RAID-5 log plexes to log information about data and parity being written to the volume.



After creating a volume using `vxmake`, you must initialize it before it can be used. The procedure is described in [“Initializing and Starting a Volume”](#) on page 221.

Creating a Volume Using a vxmake Description File

You can use the `vxmake` command to add a new volume, plex or subdisk to the set of objects managed by VxVM. `vxmake` adds a record for each new object to the VxVM configuration database. You can create records either by specifying parameters to `vxmake` on the command line, or by using a file which contains plain-text descriptions of the objects. The file can also contain commands for performing a list of tasks. Use the following form of the command to have `vxmake` read the file from the standard input:

```
# vxmake [-g diskgroup] < description_file
```

Alternatively, you can specify the file to `vxmake` using the `-d` option:

```
# vxmake [-g diskgroup] -d description_file
```

The following sample description file defines a volume, `db`, with two plexes, `db-01` and `db-02`:

```
#rectyp #name      #options
sd      mydg03-01  disk=mydg03 offset=0 len=10000
sd      mydg03-02  disk=mydg03 offset=25000 len=10480
sd      mydg04-01  disk=mydg04 offset=0 len=8000
sd      mydg04-02  disk=mydg04 offset=15000 len=8000
sd      mydg04-03  disk=mydg04 offset=30000 len=4480
plex    db-01      layout=STRIPE ncolumn=2 stwidth=16k
                        sd=mydg03-01:0/0,mydg03-02:0/10000,mydg04-01:1/0,
mydg04-02:1/8000,mydg04-03:1/16000
sd      ramd1-01   disk=ramd1 len=640
                        comment="Hot spot for dbvol
plex    db-02      sd=ramd1-01:40320
vol     db         usetype=gen plex=db-01,db-02
                        readpol=prefer prefname=db-02
                        comment="Uses mem1 for hot spot in last 5m
```

Note The subdisk definition for plex, `db-01`, must be specified on a single line. It is shown here split across two lines because of space constraints.

The first plex, `db-01`, is striped and has five subdisks on two physical disks, `mydg03` and `mydg04`. The second plex, `db-02`, is the preferred plex in the mirror, and has one subdisk, `ramd1-01`, on a volatile memory disk.

For detailed information about how to use `vxmake`, refer to the `vxmake(1M)` manual page.

After creating a volume using `vxmake`, you must initialize it before it can be used. The procedure is described in “[Initializing and Starting a Volume Created Using vxmake](#)” on page 222.

Initializing and Starting a Volume

If you create a volume using the `vxassist` command, `vxassist` initializes and starts the volume automatically unless you specify the attribute `init=none`.

When creating a volume, you can make it immediately available for use by specifying the `-b` option to the `vxassist` command, as shown here:

```
# vxassist -b [-g diskgroup] make volume length layout=mirror
```

The `-b` option makes VxVM carry out any required initialization as a background task. It also greatly speeds up the creation of striped volumes by initializing the columns in parallel.

As an alternative to the `-b` option, you can specify the `init=active` attribute to make a new volume immediately available for use. In this example, `init=active` is specified to prevent VxVM from synchronizing the empty data plexes of a new mirrored volume:

```
# vxassist [-g diskgroup] make volume length layout=mirror \  
init=active
```

Caution There is a very small risk of errors occurring when the `init=active` attribute is used. Although written blocks are guaranteed to be consistent, read errors can arise in the unlikely event that `fsck` attempts to verify uninitialized space in the file system, or if a file remains uninitialized following a system crash. If in doubt, use the `-b` option to `vxassist` instead.

This command writes zeroes to the entire length of the volume and to any log plexes. It then makes the volume active. You can also zero out a volume by specifying the attribute `init=zero` to `vxassist`, as shown in this example:

```
# vxassist [-g diskgroup] make volume length layout=raid5 \  
init=zero
```

Note You cannot use the `-b` option to make this operation a background task.



Initializing and Starting a Volume Created Using vxmake

A volume may be initialized by running the `vxvol` command if the volume was created by the `vxmake` command and has not yet been initialized, or if the volume has been set to an uninitialized state.

To initialize and start a volume, use the following command:

```
# vxvol [-g diskgroup] start volume
```

The following command can be used to enable a volume without initializing it:

```
# vxvol [-g diskgroup] init enable volume
```

This allows you to restore data on the volume from a backup before using the following command to make the volume fully active:

```
# vxvol [-g diskgroup] init active volume
```

If you want to zero out the contents of an entire volume, use this command to initialize it:

```
# vxvol [-g diskgroup] init zero volume
```

Accessing a Volume

As soon as a volume has been created and initialized, it is available for use as a virtual disk partition by the operating system for the creation of a file system, or by application programs such as relational databases and other data management software.

Creating a volume in a disk group sets up block and character (raw) device files that can be used to access the volume:

```
/dev/vx/dsk/diskgroup/volume    block device file for volume
```

```
/dev/vx/rdsk/diskgroup/volume    character device file for volume
```

The pathnames include a directory named for the disk group. Use the appropriate device node to create, mount and repair file systems, and to lay out databases that require raw partitions.

Note As the `rootdg` disk group no longer has special significance, VxVM only creates volume device nodes for this disk group in the `/dev/vx/dsk/rootdg` and `/dev/vx/rdsk/rootdg` directories. VxVM does not create device nodes in the `/dev/vx/dsk` or `/dev/vx/rdsk` directories for the `rootdg` disk group.

Administering Volumes

8

This chapter describes how to perform common maintenance tasks on volumes in VERITAS Volume Manager (VxVM). This includes displaying volume information, monitoring tasks, adding and removing logs, resizing volumes, removing mirrors, removing volumes, and changing the layout of volumes without taking them offline.

Note You can also use the VERITAS Intelligent Storage Provisioning (ISP) feature to create and administer application volumes. These volumes are very similar to the traditional VxVM volumes that are described in this chapter. However, there are significant differences between the functionality of the two types of volumes that prevents them from being used interchangeably. Refer to the *VERITAS Storage Foundation Intelligent Storage Provisioning Administrator's Guide* for more information about creating and administering ISP application volumes.

Most VxVM commands require superuser or equivalent privileges.



Displaying Volume Information

You can use the `vxprint` command to display information about how a volume is configured.

To display the volume, plex, and subdisk record information for all volumes in the system, use the following command:

```
# vxprint -hvt
```

The `vxprint` command can also be applied to a single disk group:

```
# vxprint -g mydg -hvt
```

This is example output from this command:

V	NAME	RVG/VSET/CO	KSTATE	STATE	LENGTH	READPOL	PREFPLEX	UTYPE
PL	NAME	VOLUME	KSTATE	STATE	LENGTH	LAYOUT	NCOL/WID	MODE
SD	NAME	PLEX	DISK	DISKOFFS	LENGTH	[COL/]OFF	DEVICE	MODE
SV	NAME	PLEX	VOLNAME	NVOLLAYR	LENGTH	[COL/]OFF	AM/NM	MODE
SC	NAME	PLEX	CACHE	DISKOFFS	LENGTH	[COL/]OFF	DEVICE	MODE
DC	NAME	PARENTVOL	LOGVOL					
SP	NAME	SNAPVOL	DCO					
v	pubs	-	ENABLED	ACTIVE	22880	SELECT	-	fsgen
pl	pubs-01	pubs	ENABLED	ACTIVE	22880	CONCAT	-	RW
sd	mydg11-01	pubs-01	mydg11	0	22880	0	c1t0d0	ENA
v	voldef	-	ENABLED	ACTIVE	20480	SELECT	-	fsgen
pl	voldef-01	voldef	ENABLED	ACTIVE	20480	CONCAT	-	RW
sd	mydg12-02	voldef-0	mydg12	0	20480	0	c1t1d0	ENA

Here `v` is a volume, `pl` is a plex, and `sd` is a subdisk. The top few lines indicate the headers that match each type of output line that follows. Each volume is listed along with its associated plexes and subdisks.

Note The headings for sub-volumes (SV), storage caches (SC), data change objects (DCO) and snappoints (SP) can be ignored here. No such objects are associated with these volumes.

To display volume-related information for a specific volume, use the following command:

```
# vxprint [-g diskgroup] -t volume
```

For example, to display information about the volume, `voldef`, in the disk group, `mydg`, use the following command:

```
# vxprint -g mydg -t voldef
```

This is example output from this command:

V	NAME	RVG/VSET/COKSTATE	STATE	LENGTH	READPOL	PREFPLEX	UTYPE
v	voldef	-	ENABLED ACTIVE	20480	SELECT	-	fsgen

Note If you enable enclosure-based naming, and use the `vxprint` command to display the structure of a volume, it shows enclosure-based disk device names (disk access names) rather than `c##d##` names. See [“Discovering the Association between Enclosure-Based Disk Names and OS-Based Disk Names”](#) on page 73 for information on how to obtain the true device names.

The following section describes the meaning of the various volume states that may be displayed.

Volume States

The following volume states may be displayed by VxVM commands such as `vxprint`:

ACTIVE Volume State

The volume has been started (kernel state is currently ENABLED) or was in use (kernel state was ENABLED) when the machine was rebooted. If the volume is currently ENABLED, the state of its plexes at any moment is not certain (since the volume is in use).

If the volume is currently DISABLED, this means that the plexes cannot be guaranteed to be consistent, but are made consistent when the volume is started.

For a RAID-5 volume, if the volume is currently DISABLED, parity cannot be guaranteed to be synchronized.

CLEAN Volume State

The volume is not started (kernel state is DISABLED) and its plexes are synchronized. For a RAID-5 volume, its plex stripes are consistent and its parity is good.

EMPTY Volume State

The volume contents are not initialized. The kernel state is always DISABLED when the volume is EMPTY.



INVALID Volume State

The contents of an instant snapshot volume no longer represent a true point-in-time image of the original volume.

NEEDSYNC Volume State

The volume requires a resynchronization operation the next time it is started. For a RAID-5 volume, a parity resynchronization operation is required.

REPLAY Volume State

The volume is in a transient state as part of a log replay. A log replay occurs when it becomes necessary to use logged parity and data. This state is only applied to RAID-5 volumes.

SYNC Volume State

The volume is either in read-writeback recovery mode (kernel state is currently **ENABLED**) or was in read-writeback mode when the machine was rebooted (kernel state is **DISABLED**). With read-writeback recovery, plex consistency is recovered by reading data from blocks of one plex and writing the data to all other writable plexes. If the volume is **ENABLED**, this means that the plexes are being resynchronized through the read-writeback recovery. If the volume is **DISABLED**, it means that the plexes were being resynchronized through read-writeback when the machine rebooted and therefore still need to be synchronized.

For a RAID-5 volume, the volume is either undergoing a parity resynchronization (kernel state is currently **ENABLED**) or was having its parity resynchronized when the machine was rebooted (kernel state is **DISABLED**).

Note The interpretation of these flags during volume startup is modified by the persistent state log for the volume (for example, the **DIRTY/CLEAN** flag). If the clean flag is set, an **ACTIVE** volume was not written to by any processes or was not even open at the time of the reboot; therefore, it can be considered **CLEAN**. The clean flag is always set in any case where the volume is marked **CLEAN**.

Volume Kernel States

The *volume kernel state* indicates the accessibility of the volume. The volume kernel state allows a volume to have an offline (DISABLED), maintenance (DETACHED), or online (ENABLED) mode of operation.

Note No user intervention is required to set these states; they are maintained internally. On a system that is operating properly, all volumes are ENABLED.

The following volume kernel states are defined:

DETACHED Volume Kernel State

Maintenance is being performed on the volume. The volume cannot be read from or written to, but certain plex operations and `ioctl` function calls are accepted.

DISABLED Volume Kernel State

The volume is offline and cannot be accessed.

ENABLED Volume Kernel State

The volume is online and can be read from or written to.

Monitoring and Controlling Tasks

Note VxVM supports this feature for private disk groups, but not for shareable disk groups in a cluster environment.

The VxVM task monitor tracks the progress of system recovery by monitoring task creation, maintenance, and completion. The task monitor allows you to monitor task progress and to modify characteristics of tasks, such as pausing and recovery rate (for example, to reduce the impact on system performance).

Specifying Task Tags

Every task is given a unique *task identifier*. This is a numeric identifier for the task that can be specified to the `vxtask` utility to specifically identify a single task. Several VxVM utilities also provide a `-t` option to specify an alphanumeric tag of up to 16 characters in length. This allows you to group several tasks by associating them with the same tag.



The `vxassist`, `vxevac`, `vxplex`, `vxmirror`, `vxrecover`, `vxrelayout`, `vxresize`, `vxsd`, and `vxvol` utilities allow you to specify a tag using the `-t` option. For example, to execute a `vxrecover` command and track all the resulting tasks as a group with the task tag `myrecovery`, use the following command:

```
# vxrecover -g mydg -t myrecovery -b mydg05
```

Any tasks started by the utilities invoked by `vxrecover` also inherit its task ID and task tag, so establishing a parent-child task relationship.

For more information about the utilities that support task tagging, see their respective manual pages.

Managing Tasks with `vxtask`

Note New tasks take time to be set up, and so may not be immediately available for use after a command is invoked. Any script that operates on tasks may need to poll for the existence of a new task.

You can use the `vxtask` command to administer operations on VxVM tasks that are running on the system. Operations include listing tasks, modifying the state of a task (pausing, resuming, aborting) and modifying the rate of progress of a task. For detailed information about how to use `vxtask`, refer to the `vxtask(1M)` manual page.

VxVM tasks represent long-term operations in progress on the system. Every task gives information on the time the operation started, the size and progress of the operation, and the state and rate of progress of the operation. The administrator can change the state of a task, giving coarse-grained control over the progress of the operation. For those operations that support it, the rate of progress of the task can be changed, giving more fine-grained control over the task.

`vxtask` Operations

The `vxtask` command supports the following operations:

- | | |
|--------------------|--|
| <code>abort</code> | Causes the specified task to cease operation. In most cases, the operations “back out” as if an I/O error occurred, reversing what has been done so far to the largest extent possible. |
| <code>list</code> | Lists tasks running on the system in one-line summaries. The <code>-l</code> option prints tasks in long format. The <code>-h</code> option prints tasks hierarchically, with child tasks following the parent tasks. By default, all tasks running on the system are printed. If a <code>taskid</code> argument is supplied, the output is limited to those tasks whose <code>taskid</code> or task tag match <code>taskid</code> . The remaining arguments are used to filter tasks and limit the tasks actually listed. |

<code>monitor</code>	Prints information continuously about a task or group of tasks as task information changes. This allows you to track the progression of tasks. Specifying <code>-l</code> causes a long listing to be printed. By default, short one-line listings are printed. In addition to printing task information when a task state changes, output is also generated when the task completes. When this occurs, the state of the task is printed as <code>EXITED</code> .
<code>pause</code>	Puts a running task in the paused state, causing it to suspend operation.
<code>resume</code>	Causes a paused task to continue operation.
<code>set</code>	Changes modifiable parameters of a task. Currently, there is only one modifiable parameter, <code>slow[=<i>iodelay</i>]</code> , which can be used to reduce the impact that copy operations have on system performance. If <code>slow</code> is specified, this introduces a delay between such operations with a default value for <i>iodelay</i> of 250 milliseconds. The larger the value of <i>iodelay</i> that is specified, the slower is the progress of the task and the fewer system resources that it consumes in a given time. (The <code>slow</code> attribute is also accepted by the <code>vxplex</code> , <code>vxvol</code> and <code>vxrecover</code> commands.)

vxtask Usage

To list all tasks currently running on the system, use the following command:

```
# vxtask list
```

To print tasks hierarchically, with child tasks following the parent tasks, specify the `-h` option, as follows:

```
# vxtask -h list
```

To trace all tasks in the disk group, `foodg`, that are currently paused, as well as any tasks with the tag `sysstart`, use the following command:

```
# vxtask -g foodg -p -i sysstart list
```

Use the `vxtask -p list` command lists all paused tasks, and use `vxtask resume` to continue execution (the task may be specified by its ID or by its tag):

```
# vxtask -p list
# vxtask resume 167
```

To monitor all tasks with the tag `myoperation`, use the following command:

```
# vxtask monitor myoperation
```

To cause all tasks tagged with `recoval1` to exit, use the following command:

```
# vxtask abort recoval1
```



This command causes VxVM to attempt to reverse the progress of the operation so far. For an example of how to use `vxtask` to monitor and modify the progress of the Online Relayout feature, see [“Controlling the Progress of a Relayout”](#) on page 259.

Stopping a Volume

Stopping a volume renders it unavailable to the user, and changes the volume kernel state from `ENABLED` or `DETACHED` to `DISABLED`. If the volume cannot be disabled, it remains in its current state. To stop a volume, use the following command:

```
# vxvol [-g diskgroup] [-f] stop volume ...
```

To stop all volumes in a specified disk group, use the following command:

```
# vxvol [-g diskgroup] [-f] stopall
```

Caution If you use the `-f` option to forcibly disable a volume that is currently open to an application, the volume remains open, but its contents are inaccessible. I/O operations on the volume fail, and this may cause data loss. It is not possible to deport a disk group until all of its volumes are closed.

If you need to prevent a closed volume from being opened, it is recommended that you use the `vxvol maint` command, as described in the following section.

Putting a Volume in Maintenance Mode

If all mirrors of a volume become `STALE`, you can place the volume in maintenance mode. Then you can view the plexes while the volume is `DETACHED` and determine which plex to use for reviving the others. To place a volume in maintenance mode, use the following command:

```
# vxvol [-g diskgroup] maint volume
```

To assist in choosing the revival source plex, use `vxprint` to list the stopped volume and its plexes.

To take a plex (in this example, `vol101-02` in the disk group, `mydg`) offline, use the following command:

```
# vxmend -g mydg off vol101-02
```

The `vxmend on` command can change the state of an `OFFLINE` plex of a `DISABLED` volume to `STALE`. For example, to put a plex named `vol101-02` in the `STALE` state, use the following command:

```
# vxmend -g mydg on vol101-02
```

Running the `vxvol start` command on the volume then revives the plex as described in the next section.

Starting a Volume

Starting a volume makes it available for use, and changes the volume state from `DISABLED` or `DETACHED` to `ENABLED`. To start a `DISABLED` or `DETACHED` volume, use the following command:

```
# vxvol [-g diskgroup] start volume ...
```

If a volume cannot be enabled, it remains in its current state.

To start all `DISABLED` or `DETACHED` volumes in a disk group, enter:

```
# vxvol -g diskgroup startall
```

Alternatively, to start a `DISABLED` volume, use the following command:

```
# vxrecover -g diskgroup -s volume ...
```

To start all `DISABLED` volumes, enter:

```
# vxrecover -s
```

To prevent any recovery operations from being performed on the volumes, additionally specify the `-n` option to `vxrecover`.

Adding a Mirror to a Volume

A mirror can be added to an existing volume with the `vxassist` command, as follows:

```
# vxassist [-b] [-g diskgroup] mirror volume
```

Note If specified, the `-b` option makes synchronizing the new mirror a background task.

For example, to create a mirror of the volume `voltest` in the disk group, `mydg`, use the following command:

```
# vxassist -b -g mydg mirror voltest
```

Another way to mirror an existing volume is by first creating a plex, and then attaching it to a volume, using the following commands:

```
# vxmake [-g diskgroup] plex plex sd=subdisk ...  
# vxplex [-g diskgroup] att volume plex
```



Mirroring All Volumes

To mirror all volumes in a disk group to available disk space, use the following command:

```
# /etc/vx/bin/vxmirror -g diskgroup -a
```

To configure VxVM to create mirrored volumes by default, use the following command:

```
# /etc/vx/bin/vxmirror -d yes
```

If you make this change, you can still make unmirrored volumes by specifying `nmirror=1` as an attribute to the `vxassist` command. For example, to create an unmirrored 20-gigabyte volume named `nomirror` in the disk group, `mydg`, use the following command:

```
# vxassist -g mydg make nomirror 20g nmirror=1
```

Mirroring Volumes on a VM Disk

Mirroring volumes on a VM disk gives you one or more copies of your volumes in another disk location. By creating mirror copies of your volumes, you protect your system against loss of data in case of a disk failure.

Note This task only mirrors concatenated volumes. Volumes that are already mirrored or that contain subdisks that reside on multiple disks are ignored.

To mirror volumes on a disk, make sure that the target disk has an equal or greater amount of space as the originating disk and then do the following:

1. Select menu item 5 (Mirror volumes on a disk) from the `vxdiskadm` main menu.
2. At the following prompt, enter the disk name of the disk that you wish to mirror:

```
Mirror volumes on a disk  
Menu: VolumeManager/Disk/Mirror
```

```
This operation can be used to mirror volumes on a disk. These  
volumes can be mirrored onto another disk or onto any  
available disk space. Volumes will not be mirrored if they are  
already mirrored. Also, volumes that are comprised of more than  
one subdisk will not be mirrored.
```

```
Enter disk name [<disk>,list,q,?] mydg02
```

3. At the following prompt, enter the target disk name (this disk must be the same size or larger than the originating disk):

You can choose to mirror volumes from disk mydg02 onto any available disk space, or you can choose to mirror onto a specific disk. To mirror to a specific disk, select the name of that disk. To mirror to any available disk space, select "any". Enter destination disk [*<disk>*,*list,q,?*] (default: any) **mydg01**

4. At the following prompt, press Return to make the mirror:

The requested operation is to mirror all volumes on disk mydg02 in disk group mydg onto available disk space on disk mydg01.

VxVM NOTICE V-5-2-229 This operation can take a long time to complete.

Continue with operation? [*y,n,q,?*] (default: y)

The `vxdiskadm` program displays the status of the mirroring operation, as follows:

VxVM vxmirror INFO V-5-2-22 Mirror volume voltest-bk00 ...

VxVM INFO V-5-2-674 Mirroring of disk mydg01 is complete.

5. At the following prompt, indicate whether you want to mirror volumes on another disk (**y**) or return to the `vxdiskadm` main menu (**n**):

Mirror volumes on another disk? [*y,n,q,?*] (default: n)

Removing a Mirror

When a mirror is no longer needed, you can remove it to free up disk space.

Note The last valid plex associated with a volume cannot be removed.

To remove a mirror from a volume, use the following command:

```
# vxassist [-g diskgroup] remove mirror volume
```

Additionally, you can use storage attributes to specify the storage to be removed. For example, to remove a mirror on disk mydg01 from volume vol01, enter:

```
# vxassist -g mydg remove mirror vol01 !mydg01
```

For more information about storage attributes, see [“Creating a Volume on Specific Disks”](#) on page 203.

Alternatively, use the following command to dissociate and remove a mirror from a volume:

```
# vxplex [-g diskgroup] -o rm dis plex
```



For example, to dissociate and remove a mirror named `vol01-02` from the disk group, `mydg`, use the following command:

```
# vxplex -g mydg -o rm dis vol01-02
```

This command removes the mirror `vol01-02` and all associated subdisks. This is equivalent to entering the following separate commands:

```
# vxplex -g mydg dis vol01-02
# vxedit -g mydg -r rm vol01-02
```

Adding Logs and Maps to Volumes

In VERITAS Volume Manager, several types of volume logs and maps are supported:

- ◆ FastResync Maps are used to perform quick and efficient resynchronization of mirrors (see [“FastResync”](#) on page 49 for details). These maps are supported either in memory (Non-Persistent FastResync), or on disk as part of a DCO volume (Persistent FastResync). Two types of DCO volumes are supported:
 - ◆ Version 0 DCO volumes only support Persistent FastResync for the traditional third-mirror break-off type of volume snapshot. See [“Version 0 DCO Volume Layout”](#) on page 51, and [“Adding a Version 0 DCO and DCO Volume”](#) on page 307 for more information.
 - ◆ Version 20 DCO volumes, introduced in VxVM 4.0, support DRL logging (see below) and Persistent FastResync for full-sized and space-optimized instant volume snapshots. See [“Version 20 DCO Volume Layout”](#) on page 51, and [“Preparing a Volume for DRL and Instant Snapshots”](#) on page 235 for more information.
- See [“Enabling FastResync on a Volume”](#) on page 252 for information on how to enable Persistent or Non-Persistent FastResync on a volume.
- ◆ Dirty Region Logs allow the fast recovery of mirrored volumes after a system crash (see [“Dirty Region Logging \(DRL\)”](#) on page 42 for details). These logs are supported either as DRL log plexes, or as part of a version 20 DCO volume. Refer to the following sections for information on enabling DRL on a volume:
 - ◆ [“Adding Traditional DRL Logging to a Mirrored Volume”](#) on page 242 describes how to add DRL log plexes to a volume.
 - ◆ [“Preparing a Volume for DRL and Instant Snapshots”](#) on page 235 describes how to configure DRL for a volume using a version 20 DCO volume.
- ◆ RAID-5 logs are used to prevent corruption of data during recovery of RAID-5 volumes (see [“RAID-5 Logging”](#) on page 33 for details). These logs are configured as plexes on disks other than those that are used for the columns of the RAID-5 volume.

See [“Adding a RAID-5 Log”](#) on page 243 for information on adding RAID-5 logs to a RAID-5 volume.

Preparing a Volume for DRL and Instant Snapshots

Note This procedure describes how to add a version 20 data change object (DCO) and DCO volume to a volume that you previously created in a disk group with a version number of 110 or greater. If you are creating a new volume in a disk group with a version number of 110 or greater, you can specify the co-creation of a DCO and DCO volume and enable DRL as described in [“Creating a Volume with a Version 20 DCO Volume”](#) on page 212. If the volume was created in a release prior to VxVM 4.0, use the procedure in [“Upgrading Existing Volumes to Use Version 20 DCOs”](#) on page 240.

You need a full VxVM license and a VERITAS FlashSnap™ or FastResync license to use the DRL and FastResync features. Even if you do not have a license, you can configure a DCO object and DCO volume so that snap objects are associated with the original and snapshot volumes. For more information about snap objects, see [“How Persistent FastResync Works with Snapshots”](#) on page 53. See [“Determining the DCO Version Number”](#) on page 238 for details of how to determine the version number of a volume’s DCO.

Use the following command to add a version 20 DCO and DCO volume to a volume:

```
# vxsnap [-g diskgroup] prepare volume [ndcomirs=number] \  
    [regionsize=size] [drl=on|sequential|off] \  
    [storage_attribute ...]
```

The `ndcomirs` attribute specifies the number of DCO plexes that are created in the DCO volume. It is recommended that you configure as many DCO plexes as there are data and snapshot plexes in the volume. The DCO plexes are used to set up a DCO volume for any snapshot volume that you subsequently create from the snapshot plexes. For example, specify `ndcomirs=5` for a volume with 3 data plexes and 2 snapshot plexes.

The value of the `regionsize` attribute specifies the size of the tracked regions in the volume. A write to a region is tracked by setting a bit in the change map. The default value is 64k (64KB). A smaller value requires more disk space for the change maps, but the finer granularity provides faster resynchronization.

To enable DRL logging on the volume, specify `drl=on` (this is the default setting). If sequential DRL is required, specify `drl=sequential`. If DRL is not required, specify `drl=off`.



You can also specify `vxassist`-style storage attributes to define the disks that can and/or cannot be used for the plexes of the DCO volume. See [“Specifying Storage for Version 20 DCO Plexes”](#) on page 236 for details.

Note The `vxsnap prepare` command automatically enables Persistent FastResync on the volume. Persistent FastResync is also set automatically on any snapshots that are generated from a volume on which this feature is enabled.

If the volume is a RAID-5 volume, it is converted to a layered volume that can be used with instant snapshots and Persistent FastResync. See [“Using a DCO and DCO Volume with a RAID-5 Volume”](#) on page 237 for details.

By default, a version 20 DCO volume contains 32 per-volume maps. If you require more maps than this, you can use the `vxsnap addmap` command to add more maps. See the `vxsnap(1M)` manual page for details of this command.

Specifying Storage for Version 20 DCO Plexes

If the disks that contain volumes and their snapshots are to be moved into different disk groups, you must ensure that the disks that contain their DCO plexes can accompany them. You can use storage attributes to specify which disks to use for the DCO plexes. (If you do not want to use dirty region logging (DRL) with a volume, you can specify the same disks as those on which the volume is configured, assuming that space is available on the disks). For example, to add a DCO object and mirrored DCO volume with plexes on `disk05` and `disk06` to the volume, `myvol`, use the following command:

```
# vxsnap -g mydg prepare myvol ndcomirs=2 disk05 disk06
```

To view the details of the DCO object and DCO volume that are associated with a volume, use the `vxprint` command. The following is example `vxprint -vh` output for the volume named `vol1` (the `TUTIL0` and `PUTIL0` columns are omitted for clarity):

TY	NAME	ASSOC	KSTATE	LENGTH	PLOFFS	STATE	...
v	vol1	fsgen	ENABLED	1024	-	ACTIVE	
pl	vol1-01	vol1	ENABLED	1024	-	ACTIVE	
sd	disk01-01	vol1-01	ENABLED	1024	0	-	
pl	foo-02	vol1	ENABLED	1024	-	ACTIVE	
sd	disk02-01	vol1-02	ENABLED	1024	0	-	
dc	vol1_dco	vol1	-	-	-	-	
v	vol1_dcl	gen	ENABLED	132	-	ACTIVE	
pl	vol1_dcl-01	vol1_dcl	ENABLED	132	-	ACTIVE	
sd	disk03-01	vol1_dcl-01	ENABLED	132	0	-	
pl	vol1_dcl-02	vol1_dcl	ENABLED	132	-	ACTIVE	
sd	disk04-01	vol1_dcl-02	ENABLED	132	0	-	

In this output, the DCO object is shown as `vol1_dco`, and the DCO volume as `vol1_dc1` with 2 plexes, `vol1_dc1-01` and `vol1_dc1-02`.

If required, you can use the `vxassist move` command to relocate DCO plexes to different disks. For example, the following command moves the plexes of the DCO volume, `vol1_dc1`, for volume `vol1` from `disk03` and `disk04` to `disk07` and `disk08`:

```
# vxassist -g mydg move vol1_dc1 !disk03 !disk04 disk07 disk08
```

For more information, see “[Moving DCO Volumes Between Disk Groups](#)” on page 161, and the `vxassist(1M)` and `vxsnap(1M)` manual pages.

Using a DCO and DCO Volume with a RAID-5 Volume

The procedure in the previous section can be used to add a DCO and DCO volume to a RAID-5 volume. This allows you to use Persistent FastResync on the volume for fast resynchronization of snapshots on returning them to their original volume. However, the procedure has the side effect of converting the RAID-5 volume into a special type of layered volume. You can create space-optimized instant snapshots of such a volume, and you can add mirrors that may be broken off as full-sized instant snapshots. You cannot relayout or resize such a volume unless you convert it back to a pure RAID-5 volume.

To convert a volume back to a RAID-5 volume, remove any snapshot plexes from the volume, and dissociate the DCO and DCO volume from the layered volume using the procedure described in “[Removing Support for DRL and Instant Snapshots from a Volume](#)” on page 239. You can then perform relayout and resize operations on the resulting non-layered RAID-5 volume.

To allow Persistent FastResync to be used with the RAID-5 volume again, re-associate the DCO and DCO volume as described in “[Preparing a Volume for DRL and Instant Snapshots](#)” on page 235.

Note Dissociating a DCO and DCO volume disables FastResync on the volume. A full resynchronization of any remaining snapshots is required when they are snapped back.



Determining the DCO Version Number

The instant snapshot and DRL-enabled DCO features require that a version 20 DCO be associated with a volume, rather than an earlier version 0 DCO.

To find out the version number of a DCO that is associated with a volume:

1. Use the `vxprint` command on the volume to discover the name of its DCO:

```
# DCONAME=`vxprint [-g diskgroup] -F%dco_name volume`
```

2. Use the `vxprint` command on the DCO to determine its version number:

```
# vxprint [-g diskgroup] -F%version $DCONAME
```

Determining if DRL is Enabled on a Volume

To determine if DRL (configured using a version 20 DCO volume) is enabled on a volume:

1. Use the `vxprint` command on the volume to discover the name of its DCO:

```
# DCONAME=`vxprint [-g diskgroup] -F%dco_name volume`
```

2. To determine if DRL is enabled on the volume, use the following command with the volume's DCO:

```
# vxprint [-g diskgroup] -F%drl $DCONAME
```

DRL is enabled if this command displays on.

3. If DRL is enabled, use this command with the DCO to determine if sequential DRL is enabled:

```
# vxprint [-g diskgroup] -F%sequentialdrl $DCONAME
```

Sequential DRL is enabled if this command displays on.

Alternatively, you can use this command with the volume:

```
# vxprint [-g diskgroup] -F%log_type volume
```

This displays the logging type as `REGION` for DRL, `DRLSEQ` for sequential DRL, or `NONE` if DRL is not enabled.

Note If the number of active mirrors in the volume is less than 2, DRL logging is not performed even if DRL is enabled on the volume. To find out if DRL logging is active, see [“Determining if DRL Logging is Active on a Volume”](#) on page 239.

Determining if DRL Logging is Active on a Volume

To determine if DRL logging is active on a mirrored volume:

1. Use the following `vxprint` commands to discover the name of the volume's DCO volume:

```
# DCONAME=`vxprint [-g diskgroup] -F%dco_name volume`
# DCOVOL=`vxprint [-g diskgroup] -F%parent_vol $DCONAME`
```

2. Use the `vxprint` command on the DCO volume to find out if DRL logging is active:

```
# vxprint [-g diskgroup] -F%drllogging $DCOVOL
```

This command returns on if DRL logging is enabled.

Disabling and Re-enabling DRL

To disable DRL (configured using a version 20 DCO volume) on a volume, enter the following command:

```
# vxvol [-g diskgroup] set drl=off volume
```

To re-enable DRL on a volume, enter this command:

```
# vxvol [-g diskgroup] set drl=on volume
```

To re-enable sequential DRL on a volume, enter:

```
# vxvol [-g diskgroup] set drl=sequential volume
```

You can use these commands to change the DRL policy on a volume by first disabling and then re-enabling DRL as required. DRL is automatically disabled if a data change map (DCM, used with VERITAS Volume Replicator) is attached to a volume.

Removing Support for DRL and Instant Snapshots from a Volume

To remove support for DRL and instant snapshot operation from a volume, use the following command to remove the DCO and DCO volume that are associated with the volume:

```
# vxsnap [-g diskgroup] unprepare volume
```

This command also has the effect of disabling FastResync tracking on the volume.

Note This command fails if the volume is part of a snapshot hierarchy.



Upgrading Existing Volumes to Use Version 20 DCOs

The procedure described in this section describes how to upgrade a volume created before VxVM 4.0 so that it can take advantage of new features such as instant snapshots, and DRL logs that are configured within the DCO volume. This requires upgrading the version of the disk groups, removing any existing snapshots and version 0 DCOs that are associated with volumes in the disk groups, and finally configuring the volumes with version 20 DCOs.

Note The plexes of the DCO volume require persistent storage space on disk to be available. To make room for the DCO plexes, you may need to add extra disks to the disk group, or reconfigure existing volumes to free up space in the disk group. Another way to add disk space is to use the disk group move feature to bring in spare disks from a different disk group. For more information, see [“Reorganizing the Contents of Disk Groups”](#) on page 155.

Perform the following steps to upgrade an existing disk group and the volumes that it contains:

1. Upgrade the disk group that contains the volume to the latest version before performing the remainder of the procedure described in this section. Use the following command to check the version of a disk group:

```
# vxdg list diskgroup
```

To upgrade a disk group to the latest version, use the following command:

```
# vxdg upgrade diskgroup
```

For more information, see [“Upgrading a Disk Group”](#) on page 169.

2. Use the following command to discover which volumes in the disk group have version 0 DCOs associated with them:

```
# vxprint [-g diskgroup] -F "%name" -e "v_hasdcolog"
```

Note This command assumes that the volumes can only have version 0 DCOs as the disk group has just been upgraded. See [“Determining the DCO Version Number”](#) on page 238 for a description of how to find out the DCO version number of a volume in any disk group.

3. Repeat the following steps to upgrade each volume within the disk group as required:

- a. If the volume to be upgraded has a traditional DRL plex or subdisk (that is, the DRL logs are not held in a version 20 DCO volume), use the following command to remove this:

```
# vxassist [-g diskgroup] remove log volume [nlog=n]
```

Use the optional attribute `nlog=n` to specify the number, *n*, of logs to be removed. By default, the `vxassist` command removes one log.

- b. For a volume that has one or more associated snapshot volumes, use the following command to reattach and resynchronize each snapshot:

```
# vxassist [-g diskgroup] snapback snapvol
```

If `FastResync` was enabled on the volume before the snapshot was taken, the data in the snapshot plexes is quickly resynchronized from the original volume. If `FastResync` was not enabled, a full resynchronization is performed.

- c. Use the following command to turn off `FastResync` for the volume:

```
# vxvol [-g diskgroup] set fastresync=off volume
```

- d. Use the following command to dissociate a version 0 DCO object, DCO volume and snap objects from the volume:

```
# vxassist [-g diskgroup] remove log volume logtype=dco
```

- e. Use the following command on the volume to upgrade it:

```
# vxsnap [-g diskgroup] prepare volume [ndcomirs=number] \  
[regionsize=size] [drl=on|sequential|off] \  
[storage_attribute ...]
```

The `ndcomirs` attribute specifies the number of DCO plexes that are created in the DCO volume. It is recommended that you configure as many DCO plexes as there are data and snapshot plexes in the volume. The DCO plexes are used to set up a DCO volume for any snapshot volume that you subsequently create from the snapshot plexes. For example, specify `ndcomirs=5` for a volume with 3 data plexes and 2 snapshot plexes.

The value of the `regionsize` attribute specifies the size of the tracked regions in the volume. A write to a region is tracked by setting a bit in the change map. The default value is 64k (64KB). A smaller value requires more disk space for the change maps, but the finer granularity provides faster resynchronization.

To enable DRL logging on the volume, specify `drl=on` (this is the default setting). If sequential DRL is required, specify `drl=sequential`. If DRL is not required, specify `drl=off`.



You can also specify `vxassist`-style storage attributes to define the disks that can or cannot be used for the plexes of the DCO volume.

Note The `vxsnap prepare` command automatically enables FastResync on the volume and on any snapshots that are generated from it.

If the volume is a RAID-5 volume, it is converted to a layered volume that can be used with snapshots and FastResync.

Adding Traditional DRL Logging to a Mirrored Volume

Note The procedure described in this section creates a DRL log that is configured within a dedicated DRL plex. The version 20 DCO volume layout includes space for a DRL log. The new DCO volume layout also supports traditional (third-mirror), instant (copy-on-write), and instant space-optimized snapshots. However, a version 20 DCO volume cannot be used in conjunction with a separate DRL plex. For full details, see [“Preparing a Volume for DRL and Instant Snapshots”](#) on page 235.

To put dirty region logging (DRL) into effect for a mirrored volume, a log subdisk must be added to that volume. Only one log subdisk can exist per plex.

To add DRL logs to an existing volume, use the following command:

```
# vxassist [-b] [-g diskgroup] addlog volume logtype=drl [nlog=n] \  
[loglen=size]
```

Note If specified, the `-b` option makes adding the new logs a background task.

The `nlog` attribute can be used to specify the number of log plexes to add. By default, one log plex is added. The `loglen` attribute specifies the size of the log, where each bit represents one region in the volume. For example, the size of the log would need to be 20K for a 10GB volume with a region size of 64 kilobytes.

For example, to add a single log plex for the volume `vo103`, in the disk group, `mydg`, use the following command:

```
# vxassist -g mydg addlog vo103 logtype=drl
```

When the `vxassist` command is used to add a log subdisk to a volume, by default a log plex is also created to contain the log subdisk unless you include the keyword `nolog` in the layout specification.

For a volume that will be written to sequentially, such as a database log volume, include the `logtype=drlseq` attribute to specify that sequential DRL is to be used:

```
# vxassist -g mydg addlog volume logtype=drlseq [nlog=n]
```

Once created, the plex containing a log subdisk can be treated as a regular plex. Data subdisks can be added to the log plex. The log plex and log subdisk can be removed using the procedure described in “[Removing a Traditional DRL Log](#)” on page 243.

Removing a Traditional DRL Log

Note The procedure described in this section removes a DRL log that is configured within a dedicated DRL plex. The version 20 DCO volume layout includes space for a DRL log.

To remove a DRL log, use the `vxassist` command as follows:

```
# vxassist [-g diskgroup] remove log volume logtype=drl [nlog=n]
```

By default, the `vxassist` command removes one log. Use the optional attribute `nlog=n` to specify the number of logs that are to remain after the operation completes.

You can use storage attributes to specify the storage from which a log is to be removed. For example, to remove a log on disk `mydg10` from volume `vol01`, enter:

```
# vxassist -g mydg remove log vol01 !mydg10 logtype=drl
```

Adding a RAID-5 Log

Note You need a full license to use this feature.

Only one RAID-5 plex can exist per RAID-5 volume. Any additional plexes become RAID-5 log plexes, which are used to log information about data and parity being written to the volume. When a RAID-5 volume is created using the `vxassist` command, a log plex is created for that volume by default.

To add a RAID-5 log to an existing volume, use the following command:

```
# vxassist [-b] [-g diskgroup] addlog volume [loglen=length]
```

Note If specified, the `-b` option makes adding the new log a background task.

You can specify the log length used when adding the first log to a volume. Any logs that you add subsequently are configured with the same length as the existing log.

For example, to create a log for the RAID-5 volume `volraid`, in the disk group, `mydg`, use the following command:

```
# vxassist -g mydg addlog volraid
```



Adding a RAID-5 Log using vxplex

As an alternative to using `vxassist`, you can add a RAID-5 log using the `vxplex` command. For example, to attach a RAID-5 log `r5log`, to a RAID-5 volume, `r5vol`, in the disk group, `mydg`, use the following command:

```
# vxplex -g mydg att r5vol r5log
```

The attach operation can only proceed if the size of the new log is large enough to hold all of the data on the stripe. If the RAID-5 volume already contains logs, the new log length is the minimum of each individual log length. This is because the new log is a mirror of the old logs.

If the RAID-5 volume is not enabled, the new log is marked as BADLOG and is enabled when the volume is started. However, the contents of the log are ignored.

If the RAID-5 volume is enabled and has other enabled RAID-5 logs, the new log's contents are synchronized with the other logs.

If the RAID-5 volume currently has no enabled logs, the new log is zeroed before it is enabled.

Removing a RAID-5 Log

To identify the plex of the RAID-5 log, use the following command:

```
# vxprint [-g diskgroup] -ht volume
```

where *volume* is the name of the RAID-5 volume. For a RAID-5 log, the output lists a plex with a STATE field entry of LOG.

To dissociate and remove a RAID-5 log and any associated subdisks from an existing volume, use the following command:

```
# vxplex [-g diskgroup] -o rm dis plex
```

For example, to dissociate and remove the log plex `volraid-02` from `volraid` in the disk group, `mydg`, use the following command:

```
# vxplex -g mydg -o rm dis volraid-02
```

You can also remove a RAID-5 log with the `vxassist` command, as follows:

```
# vxassist [-g diskgroup] remove log volume [nlog=n]
```

By default, the `vxassist` command removes one log. Use the optional attribute `nlog=n` to specify the number of logs that are to remain after the operation completes.

Note When removing the log leaves the volume with less than two valid logs, a warning is printed and the operation is not allowed to continue. The operation may be forced by additionally specifying the `-f` option to `vxplex` or `vxassist`.

Resizing a Volume

Resizing a volume changes the volume size. For example, you might need to increase the length of a volume if it is no longer large enough for the amount of data to be stored on it. To resize a volume, use one of the commands: `vxresize` (preferred), `vxassist`, or `vxvol`. Alternatively, you can use the graphical VERITAS Enterprise Administrator (VEA) to resize volumes.

If a volume is increased in size, the `vxassist` command automatically locates available disk space. The `vxresize` command requires that you specify the names of the disks to be used to increase the size of a volume. The `vxvol` command requires that you have previously ensured that there is sufficient space available in the plexes of the volume to increase its size. The `vxassist` and `vxresize` commands automatically free unused space for use by the disk group. For the `vxvol` command, you must do this yourself. To find out by how much you can grow a volume, use the following command:

```
# vxassist [-g diskgroup] maxgrow volume
```

When you resize a volume, you can specify the length of a new volume in sectors, kilobytes, megabytes, or gigabytes. The unit of measure is added as a suffix to the length (`s`, `m`, `k`, or `g`). If no unit is specified, sectors are assumed. The `vxassist` command also allows you to specify an increment by which to change the volume's size.

Caution If you use `vxassist` or `vxvol` to resize a volume, do not shrink it below the size of the file system which is located on it. If you do not shrink the file system first, you risk unrecoverable data loss. If you have a VxFS file system, shrink the file system first, and then shrink the volume. Other file systems may require you to back up your data so that you can later recreate the file system and restore its data.



Resizing Volumes using vxresize

Use the `vxresize` command to resize a volume containing a file system. Although other commands can be used to resize volumes containing file systems, the `vxresize` command offers the advantage of automatically resizing certain types of file system as well as the volume.

See the following table for details of what operations are permitted and whether the file system must first be unmounted to resize the file system:

Permitted Resizing Operations on File Systems

	Online JFS (Full-VxFS)	Base JFS (Lite-VxFS)	HFS
Mounted File System	Grow and shrink	Not allowed	Not allowed
Unmounted File System	Grow only	Grow only	Grow only

For example, the following command resizes the 1-gigabyte volume, `homevol`, in the disk group, `mydg`, that contains a VxFS file system to 10 gigabytes using the spare disks `mydg10` and `mydg11`:

```
# vxresize -g mydg -b -F vxfs -t homevolresize homevol 10g \
  mydg10 mydg11
```

The `-b` option specifies that this operation runs in the background. Its progress can be monitored by specifying the task tag `homevolresize` to the `vxtask` command.

Note the following restrictions for using `vxresize`:

- ◆ `vxresize` works with VxFS, JFS (derived from VxFS) and HFS file systems only.
- ◆ In some situations, when resizing large volumes, `vxresize` may take a long time to complete.
- ◆ Resizing a volume with a usage type other than FSGEN or RAID5 can result in loss of data. If such an operation is required, use the `-f` option to forcibly resize such a volume.
- ◆ You cannot resize a volume that contains plexes with different layout types. Attempting to do so results in the following error message:

```
VxVM vxresize ERROR V-5-1-2536 Volume volume has different
organization in each mirror
```

To resize such a volume successfully, you must first reconfigure it so that each data plex has the same layout.

For more information about the `vxresize` command, see the `vxresize(1M)` manual page.



Resizing Volumes using `vxassist`

The following modifiers are used with the `vxassist` command to resize a volume:

- ◆ `growto`—increase volume to a specified length
- ◆ `growby`—increase volume by a specified amount
- ◆ `shrinkto`—reduce volume to a specified length
- ◆ `shrinkby`—reduce volume by a specified amount

Extending to a Given Length

To extend a volume *to* a specific length, use the following command:

```
# vxassist [-b] [-g diskgroup] growto volume length
```

Note If specified, the `-b` option makes growing the volume a background task.

For example, to extend `volcat` to 2000 sectors, use the following command:

```
# vxassist -g mydg growto volcat 2000
```

Note If you previously performed a layout on the volume, additionally specify the attribute `layout=nodiskalign` to the `growto` command if you want the subdisks to be grown using contiguous disk space.

Extending by a Given Length

To extend a volume *by* a specific length, use the following command:

```
# vxassist [-b] [-g diskgroup] growby volume length
```

Note If specified, the `-b` option makes growing the volume a background task.

For example, to extend `volcat` by 100 sectors, use the following command:

```
# vxassist -g mydg growby volcat 100
```

Note If you previously performed a layout on the volume, additionally specify the attribute `layout=nodiskalign` to the `growby` command if you want the subdisks to be grown using contiguous disk space.



Shrinking to a Given Length

To shrink a volume *to* a specific length, use the following command:

```
# vxassist [-g diskgroup] shrinkto volume length
```

For example, to shrink `volcat` to 1300 sectors, use the following command:

```
# vxassist -g mydg shrinkto volcat 1300
```

Caution Do not shrink the volume below the current size of the file system or database using the volume. The `vxassist shrinkto` command can be safely used on empty volumes.

Shrinking by a Given Length

To shrink a volume *by* a specific length, use the following command:

```
# vxassist [-g diskgroup] shrinkby volume length
```

For example, to shrink `volcat` by 300 sectors, use the following command:

```
# vxassist -g mydg shrinkby volcat 300
```

Caution Do not shrink the volume below the current size of the file system or database using the volume. The `vxassist shrinkby` command can be safely used on empty volumes.

Resizing Volumes using vxvol

To change the length of a volume using the `vxvol set` command, use the following command:

```
# vxvol [-g diskgroup] set len=length volume
```

For example, to change the length of the volume, `vol01`, in the disk group, `mydg`, to 100000 sectors, use the following command:

```
# vxvol -g mydg set len=100000 vol01
```

Note The `vxvol set len` command cannot increase the size of a volume unless the needed space is available in the plexes of the volume. When the size of a volume is reduced using the `vxvol set len` command, the freed space is not released into the disk group's free space pool.

If a volume is active and its length is being reduced, the operation must be forced using the `-o force` option to `vxvol`. This prevents accidental removal of space from applications using the volume.

The length of logs can also be changed using the following command:

```
# vxvol [-g diskgroup] set loglen=length log_volume
```

Note Sparse log plexes are not valid. They must map the entire length of the log. If increasing the log length would make any of the logs invalid, the operation is not allowed. Also, if the volume is not active and is dirty (for example, if it has not been shut down cleanly), the log length cannot be changed. This avoids the loss of any of the log contents (if the log length is decreased), or the introduction of random data into the logs (if the log length is being increased).

Changing the Read Policy for Mirrored Volumes

VxVM offers the choice of the following read policies on the data plexes in a mirrored volume:

- ◆ `round` reads each plex in turn in “round-robin” fashion for each nonsequential I/O detected. Sequential access causes only one plex to be accessed. This takes advantage of the drive or controller read-ahead caching policies.
- ◆ `prefer` reads first from a plex that has been named as the preferred plex.
- ◆ `select` chooses a default policy based on plex associations to the volume. If the volume has an enabled striped plex, the `select` option defaults to preferring that plex; otherwise, it defaults to round-robin.

The read policy can be changed from `round` to `prefer` (or the reverse), or to a different preferred plex. The `vxvol rdpol` command sets the read policy for a volume.

Note You cannot set the read policy on a RAID-5 volume. RAID-5 plexes have their own read policy (RAID).

To set the read policy to `round`, use the following command:

```
# vxvol [-g diskgroup] rdpol round volume
```

For example, to set the read policy for the volume, `vol01`, in disk group, `mydg`, to round-robin, use the following command:

```
# vxvol -g mydg rdpol round vol01
```



To set the read policy to `prefer`, use the following command:

```
# vxvol [-g diskgroup] rdpol prefer volume preferred_plex
```

For example, to set the policy for `vol01` to read preferentially from the plex `vol01-02`, use the following command:

```
# vxvol -g mydg rdpol prefer vol01 vol01-02
```

To set the read policy to `select`, use the following command:

```
# vxvol [-g diskgroup] rdpol select volume
```

For more information about how read policies affect performance, see [“Volume Read Policies”](#) on page 402.

Removing a Volume

Once a volume is no longer necessary (it is inactive and its contents have been archived, for example), it is possible to remove the volume and free up the disk space for other uses.

Before removing a volume, use the following procedure to stop all activity on the volume:

1. Remove all references to the volume by application programs, including shells, that are running on the system.
2. If the volume is mounted as a file system, unmount it with this command:

```
# umount /dev/vx/dsk/diskgroup/volume
```

3. If the volume is listed in the `/etc/fstab` file, remove its entry by editing this file. Refer to your operating system documentation for more information about the format of this file and how you can modify it.
4. Stop all activity by VxVM on the volume with the command:

```
# vxvol [-g diskgroup] stop volume
```

After following these steps, remove the volume with the `vxassist` command:

```
# vxassist [-g diskgroup] remove volume volume
```

Alternatively, you can use the `vxedit` command to remove a volume:

```
# vxedit [-g diskgroup] [-r] [-f] rm volume
```

The `-r` option to `vxedit` indicates recursive removal. This removes all plexes associated with the volume and all subdisks associated with those plexes. The `-f` option to `vxedit` forces removal. This is necessary if the volume is still enabled.

Moving Volumes from a VM Disk

Before you disable or remove a disk, you can move the data from that disk to other disks on the system. To do this, ensure that the target disks have sufficient space, and then use the following procedure:

1. Select menu item 6 (Move volumes from a disk) from the vxdiskadm main menu.
2. At the following prompt, enter the disk name of the disk whose volumes you wish to move, as follows:

```
Move volumes from a disk
Menu: VolumeManager/Disk/Evacuate
Use this menu operation to move any volumes that are using a
disk onto other disks. Use this menu immediately prior to
removing a disk, either permanently or for replacement. You can
specify a list of disks to move volumes onto, or you can move the
volumes to any available disk space in the same disk group.
```

NOTE: Simply moving volumes off of a disk, without also removing the disk, does not prevent volumes from being moved onto the disk by future operations. For example, using two consecutive move operations may move volumes from the second disk to the first.

```
Enter disk name [<disk>,list,q,?] mydg01
```

You can now optionally specify a list of disks to which the volume(s) should be moved:

```
VxVM INFO V-5-2-516 You can now specify a list of disks to move
onto. Specify a list of disk media names (e.g., mydg01) all on
one line separated by blanks. If you do not enter any disk media
names, then the volumes will be moved to any available space in
the disk group.
```

At the prompt, press Return to move the volumes onto available space in the disk group, or specify the disks in the disk group that should be used:

```
Enter disks [<disk ...>,list]
VxVM NOTICE V-5-2-283 Requested operation is to move all
volumes from disk mydg01 in group mydg.
```

NOTE: This operation can take a long time to complete.

```
Continue with operation? [y,n,q,?] (default: y)
```



As the volumes are moved from the disk, the `vxdiskadm` program displays the status of the operation:

```
VxVM vxevac INFO V-5-2-24 Move volume voltest ...
```

When the volumes have all been moved, the `vxdiskadm` program displays the following success message:

```
VxVM INFO V-5-2-188 Evacuation of disk mydg02 is complete.
```

3. At the following prompt, indicate whether you want to move volumes from another disk (**y**) or return to the `vxdiskadm` main menu (**n**):

```
Move volumes from another disk? [y,n,q,?] (default: n)
```

Enabling FastResync on a Volume

Note The recommended method for enabling FastResync on a volume with a version 20 DCO is to use the `vxsnap prepare` command as described in [“Preparing a Volume for DRL and Instant Snapshots”](#) on page 235.

You need a VERITAS FlashSnap™ or FastResync license to use this feature.

FastResync performs quick and efficient resynchronization of stale mirrors. It also increases the efficiency of the VxVM snapshot mechanism when used with operations such as backup and decision support. See [“Administering Volume Snapshots”](#) on page 261 and [“FastResync”](#) on page 49 for more information.

There are two possible versions of FastResync that can be enabled on a volume:

- ◆ Persistent FastResync holds copies of the FastResync maps on disk. These can be used for the speedy recovery of mirrored volumes if a system is rebooted. This form of FastResync requires that either a version 0 or a version 20 data change object (DCO) and DCO volume first be associated with the volume.

See [“Adding a Version 0 DCO and DCO Volume”](#) on page 307, and [“Preparing a Volume for DRL and Instant Snapshots”](#) on page 235 for more information on version 0 and version 20 DCO volumes respectively.

If the existing volume was created in a previous release of VxVM, and it has any attached snapshot plexes or it is associated with any snapshot volumes, follow the procedure given in [“Upgrading Existing Volumes to Use Version 20 DCOs”](#) on page 240.

- ◆ Non-Persistent FastResync holds the FastResync maps in memory. These do not survive on a system that is rebooted.

By default, FastResync is not enabled on newly created volumes. Specify the `fastresync=on` attribute to the `vxassist` `make` command if you want to enable FastResync on a volume that you are creating.

Note It is not possible to configure both Persistent and Non-Persistent FastResync on a volume. Persistent FastResync is used if a DCO is associated with the volume. Otherwise, Non-Persistent FastResync is used.

To turn FastResync on for an existing volume, specify `fastresync=on` to the `vxvol` command as shown here:

```
# vxvol [-g diskgroup] set fastresync=on volume
```

Note To use FastResync with a snapshot, FastResync must be enabled before the snapshot is taken, and must remain enabled until after the snapback is completed.

Checking Whether FastResync is Enabled on a Volume

To check whether FastResync is enabled on a volume, use the following command:

```
# vxprint [-g diskgroup] -F%fastresync volume
```

This command returns `on` if FastResync is enabled; otherwise, it returns `off`.

If FastResync is enabled, to check whether it is Non-Persistent or Persistent FastResync, use the following command:

```
# vxprint [-g diskgroup] -F%hasdcolog volume
```

This command returns `on` if Persistent FastResync is enabled; otherwise, it returns `off`.

To list all volumes on which Non-Persistent FastResync is enabled, use the following command:

```
# vxprint [-g diskgroup] -F "%name" \
  -e "v_fastresync=on && !v_hasdcolog"
```

To list all volumes on which Persistent FastResync is enabled, use the following command:

```
# vxprint [-g diskgroup] -F "%name" -e "v_fastresync=on \
  && v_hasdcolog"
```



Disabling FastResync

Use the `vxvol` command to turn off Persistent or Non-Persistent FastResync for an existing volume, as shown here:

```
# vxvol [-g diskgroup] set fastresync=off volume
```

Turning FastResync off releases all tracking maps for the specified volume. All subsequent reattaches will not use the FastResync facility, but perform a full resynchronization of the volume. This occurs even if FastResync is later turned on.

Performing Online Relayout

Note You need a full license to use this feature.

You can use the `vxassist relayout` command to reconfigure the layout of a volume without taking it offline. The general form of this command is:

```
# vxassist [-b] [-g diskgroup] relayout volume [layout=layout] \  
[relayout_options]
```

Note If specified, the `-b` option makes relayout of the volume a background task.

The following are valid destination layout configurations as determined by the tables in “[Permitted Layout Transformations](#)” on page 255:

```
concat-mirror—concatenated-mirror  
concat or span, nostripe, nomirror—concatenated  
raid5—RAID-5 (not supported for shared disk groups)  
stripe—striped  
stripe-mirror—striped-mirror
```

For example, the following command changes a concatenated volume, `vol102`, in disk group, `mydg`, to a striped volume with the default number of columns, 2, and default stripe unit size, 64 kilobytes:

```
# vxassist -g mydg relayout vol102 layout=stripe
```

On occasions, it may be necessary to perform a relayout on a plex rather than on a volume. See “[Specifying a Plex for Relayout](#)” on page 258 for more information.

Permitted Relayout Transformations

The tables below give details of the relayout operations that are possible for each type of source storage layout.

Supported Relayout Transformations for Unmirrored Concatenated Volumes

Relayout to	From concat
concat	No.
concat-mirror	No. Add a mirror, and then use <code>vxassist convert</code> instead.
mirror-concat	No. Add a mirror instead.
mirror-stripe	No. Use <code>vxassist convert</code> after relayout to striped-mirror volume instead.
raid5	Yes. The stripe width and number of columns may be defined.
stripe	Yes. The stripe width and number of columns may be defined.
stripe-mirror	Yes. The stripe width and number of columns may be defined.

Supported Relayout Transformations for Layered Concatenated-Mirror Volumes

Relayout to	From concat-mirror
concat	No. Use <code>vxassist convert</code> , and then remove unwanted mirrors from the resulting mirrored-concatenated volume instead.
concat-mirror	No.
mirror-concat	No. Use <code>vxassist convert</code> instead.
mirror-stripe	No. Use <code>vxassist convert</code> after relayout to striped-mirror volume instead.
raid5	Yes.
stripe	Yes. This removes a mirror and adds striping. The stripe width and number of columns may be defined.
stripe-mirror	Yes. The stripe width and number of columns may be defined.



Supported Relayout Transformations for RAID-5 Volumes

Relayout to	From raid5
concat	Yes.
concat-mirror	Yes.
mirror-concat	No. Use <code>vxassist convert</code> after relayout to concatenated-mirror volume instead.
mirror-stripe	No. Use <code>vxassist convert</code> after relayout to striped-mirror volume instead.
raid5	Yes. The stripe width and number of columns may be changed.
stripe	Yes. The stripe width and number of columns may be changed.
stripe-mirror	Yes. The stripe width and number of columns may be changed.

Supported Relayout Transformations for Mirrored-Concatenated Volumes

Relayout to	From mirror-concat
concat	No. Remove unwanted mirrors instead.
concat-mirror	No. Use <code>vxassist convert</code> instead.
mirror-concat	No.
mirror-stripe	No. Use <code>vxassist convert</code> after relayout to striped-mirror volume instead.
raid5	Yes. The stripe width and number of columns may be defined. Choose a plex in the existing mirrored volume on which to perform the relayout. The other plexes are removed at the end of the relayout operation.
stripe	Yes.
stripe-mirror	Yes.

Supported Relayout Transformations for Mirrored-Stripe Volumes

Relayout to	From mirror-stripe
concat	Yes.
concat-mirror	Yes.
mirror-concat	No. Use <code>vxassist convert</code> after relayout to concatenated-mirror volume instead.
mirror-stripe	No. Use <code>vxassist convert</code> after relayout to striped-mirror volume instead.
raid5	Yes. The stripe width and number of columns may be changed.
stripe	Yes. The stripe width or number of columns must be changed.
stripe-mirror	Yes. The stripe width or number of columns must be changed. Otherwise, use <code>vxassist convert</code> .



Supported Relayout Transformations for Unmirrored Stripe, and Layered Striped-Mirror Volumes

Relayout to	From stripe, or stripe-mirror
concat	Yes.
concat-mirror	Yes.
mirror-concat	No. Use <code>vxassist convert</code> after relayout to concatenated-mirror volume instead.
mirror-stripe	No. Use <code>vxassist convert</code> after relayout to striped-mirror volume instead.
raid5	Yes. The stripe width and number of columns may be changed.
stripe	Yes. The stripe width or number of columns must be changed.
stripe-mirror	Yes. The stripe width or number of columns must be changed.

Specifying a Non-Default Layout

You can specify one or more relayout options to change the default layout configuration. Examples of these options are:

```
ncol=number      specifies the number of columns
ncol=+number    specifies the number of columns to add
ncol=-number    specifies the number of columns to remove
stripeunit=size specifies the stripe width
```

See the `vxassist(1M)` manual page for more information about relayout options.

The following are some examples of using `vxassist` to change the stripe width and number of columns for a striped volume in the disk group `dbaseg`:

```
# vxassist -g dbaseg relayout vol103 stripeunit=64k ncol=6
# vxassist -g dbaseg relayout vol103 ncol=+2
# vxassist -g dbaseg relayout vol103 stripeunit=128k
```

The next example changes a concatenated volume to a RAID-5 volume with four columns:

```
# vxassist -g fsgrp relayout vol104 layout=raid5 ncol=4
```



Specifying a Plex for Relayout

Any layout can be changed to RAID-5 if there are sufficient disks and space in the disk group. If you convert a mirrored volume to RAID-5, you must specify which plex is to be converted. All other plexes are removed when the conversion has finished, releasing their space for other purposes. If you convert a mirrored volume to a layout other than RAID-5, the unconverted plexes are not removed. You can specify the plex to be converted by naming it in place of a volume:

```
# vxassist [-g diskgroup] relayout plex [layout=layout] \  
[relayout_options]
```

Tagging a Relayout Operation

If you want to control the progress of a relayout operation, for example to pause or reverse it, use the `-t` option to `vxassist` to specify a task tag for the operation. For example, this relayout is performed as a background task and has the tag `myconv`:

```
# vxassist -b -g fsgrp -t myconv relayout vol104 layout=raid5 ncol=4
```

See the following sections, “[Viewing the Status of a Relayout](#)” on page 258 and “[Controlling the Progress of a Relayout](#)” on page 259, for more information about tracking and controlling the progress of relayout.

Viewing the Status of a Relayout

Online relayout operations take some time to perform. You can use the `vxrelayout` command to obtain information about the status of a relayout operation. For example, the command:

```
# vxrelayout -g mydg status vol104
```

might display output similar to this:

```
STRIPED, columns=5, stwidth=128--> STRIPED, columns=6, stwidth=128  
Relayout running, 68.58% completed.
```

In this example, the reconfiguration of a striped volume from 5 to 6 columns is in progress, and is just over two-thirds complete.

See the `vxrelayout(1M)` manual page for more information about this command.

If you specified a task tag to `vxassist` when you started the relayout, you can use this tag with the `vxtask` command to monitor the progress of the relayout. For example, to monitor the task tagged as `myconv`, enter:

```
# vxtask monitor myconv
```

Controlling the Progress of a Relayout

You can use the `vxtask` command to stop (pause) the relayout temporarily, or to cancel it altogether (`abort`). If you specified a task tag to `vxassist` when you started the relayout, you can use this tag to specify the task to `vxtask`. For example, to pause the relayout operation tagged as `myconv`, enter:

```
# vxtask pause myconv
```

To resume the operation, use the `vxtask` command:

```
# vxtask resume myconv
```

For relayout operations that have not been stopped using the `vxtask pause` command (for example, the `vxtask abort` command was used to stop the task, the transformation process died, or there was an I/O failure), resume the relayout by specifying the `start` keyword to `vxrelayout`, as shown here:

```
# vxrelayout -g mydg -o bg start vol04
```

Note If you use the `vxrelayout start` command to restart a relayout that you previously suspended using the `vxtask pause` command, a new untagged task is created to complete the operation. You cannot then use the original task tag to control the relayout.

The `-o bg` option restarts the relayout in the background. You can also specify the `slow` and `iosize` option modifiers to control the speed of the relayout and the size of each region that is copied. For example, the following command inserts a delay of 1000 milliseconds (1 second) between copying each 10-megabyte region:

```
# vxrelayout -g mydg -o bg,slow=1000,iosize=10m start vol04
```

The default delay and region size values are 250 milliseconds and 1 megabyte respectively.

To reverse the direction of relayout operation that is currently stopped, specify the `reverse` keyword to `vxrelayout` as shown in this example:

```
# vxrelayout -g mydg -o bg reverse vol04
```

This undoes changes made to the volume so far, and returns it to its original layout.

If you cancel a relayout using `vxtask abort`, the direction of the conversion is also reversed, and the volume is returned to its original configuration.

See the `vxrelayout(1M)` and `vxtask(1M)` manual pages for more information about these commands. See [“Managing Tasks with vxtask”](#) on page 228 for more information about controlling tasks in VxVM.



Converting Between Layered and Non-Layered Volumes

The `vxassist convert` command transforms volume layouts between layered and non-layered forms:

```
# vxassist [-b] [-g diskgroup] convert volume [layout=layout] \  
  [convert_options]
```

Note If specified, the `-b` option makes conversion of the volume a background task.

The following conversion layouts are supported:

`stripe-mirror`—mirrored-stripe to striped-mirror

`mirror-stripe`—striped-mirror to mirrored-stripe

`concat-mirror`—mirrored-concatenated to concatenated-mirror

`mirror-concat`—concatenated-mirror to mirrored-concatenated

Volume conversion can be used before or after performing online relayout to achieve a larger number of transformations than would otherwise be possible. During relayout process, a volume may also be converted into a layout that is intermediate to the one that is desired. For example, to convert a volume from a 4-column mirrored-stripe to a 5-column mirrored-stripe, first use `vxassist relayout` to convert the volume to a 5-column striped-mirror as shown here:

```
# vxassist -g mydg relayout vol1 ncol=5
```

When the relayout has completed, use the `vxassist convert` command to change the resulting layered striped-mirror volume to a non-layered mirrored-stripe:

```
# vxassist -g mydg convert vol1 layout=mirror-stripe
```

Note If the system crashes during relayout or conversion, the process continues when the system is rebooted. However, if the crash occurred during the first stage of a two-stage relayout and convert operation, only the first stage will be completed. You must run `vxassist convert` manually to complete the operation.



VERITAS Volume Manager (VxVM) provides the capability for taking an image of a volume at a given point in time. Such an image is referred to as a *volume snapshot*. You can also take a snapshot of a volume set as described in [“Creating Instant Snapshots of Volume Sets”](#) on page 284.

Volume snapshots allow you to make backup copies of your volumes online with minimal interruption to users. You can then use the backup copies to restore data that has been lost due to disk failure, software errors or human mistakes, or to create replica volumes for the purposes of report generation, application development, or testing.

For an introduction to the volume snapshot feature, see [“Volume Snapshots”](#) on page 45. More detailed descriptions of each type of volume snapshot and the operations that you can perform on them may be found in the following sections:

- ◆ [“Traditional Third-Mirror Break-Off Snapshots”](#) on page 263
- ◆ [“Full-Sized Instant Snapshots”](#) on page 265
- ◆ [“Space-Optimized Instant Snapshots”](#) on page 267
- ◆ [“Emulation of Third-Mirror Break-Off Snapshots”](#) on page 268
- ◆ [“Cascaded Snapshots”](#) on page 269
- ◆ [“Creating Multiple Snapshots”](#) on page 273
- ◆ [“Restoring the Original Volume from a Snapshot”](#) on page 274

Note A volume snapshot represents the data that exists in a volume at a given point in time. As such, VxVM does not have any knowledge of data that is cached by the overlying file system, or by applications such as databases that have files open in the file system. If the `fsген` volume usage type is set on a volume that contains a VERITAS File System (VxFS), intent logging of the file system metadata ensures the internal consistency of the file system that is backed up. For other file system types, depending on the intent logging capabilities of the file system, there may potentially be inconsistencies between data in memory and in the snapshot image.

For databases, a suitable mechanism must additionally be used to ensure the integrity of tablespace data when the volume snapshot is taken. The facility to



temporarily suspend file system I/O is provided by most modern database software. For ordinary files in a file system, which may be open to a wide variety of different applications, there may be no way to ensure the complete integrity of the file data other than by shutting down the applications and temporarily unmounting the file system. In many cases, it may only be important to ensure the integrity of file data that is not in active use at the time that you take the snapshot.

Methods of creating volume snapshots are described in the following sections:

- ◆ “[Creating Instant Snapshots](#)” on page 275 describes how to use the `vxsnap` command to create and administer full-sized and space-optimized instant snapshots.
- ◆ “[Creating Traditional Third-Mirror Break-Off Snapshots](#)” on page 299 describes how to use the `vxassist` command to create and administer traditional third-mirror snapshots.

For details of how to use volume snapshots to implement off-host online backup, see “[Configuring Off-Host Processing](#)” on page 315.

Note Snapshot creation using the `vxsnap` command is the preferred mechanism for implementing online and off-host point-in-time copy solutions in VxVM. Support for traditional third-mirror snapshots that are created using the `vxassist` command may be removed in a future release.

Most VxVM commands require superuser or equivalent privileges.

Full details of how to recover from failures of instant snapshot commands may be found in the “Recovery from Failure of Instant Snapshot Operations” chapter of the *VERITAS Volume Manager Troubleshooting Guide*.

Traditional Third-Mirror Break-Off Snapshots

The traditional *third-mirror break-off* volume snapshot model that is supported by the `vxassist` command is shown in “[Third-Mirror Snapshot Creation and Usage](#).” This figure also shows the transitions that are supported by the `snapback` and `snapclear` commands to `vxassist`.

Third-Mirror Snapshot Creation and Usage

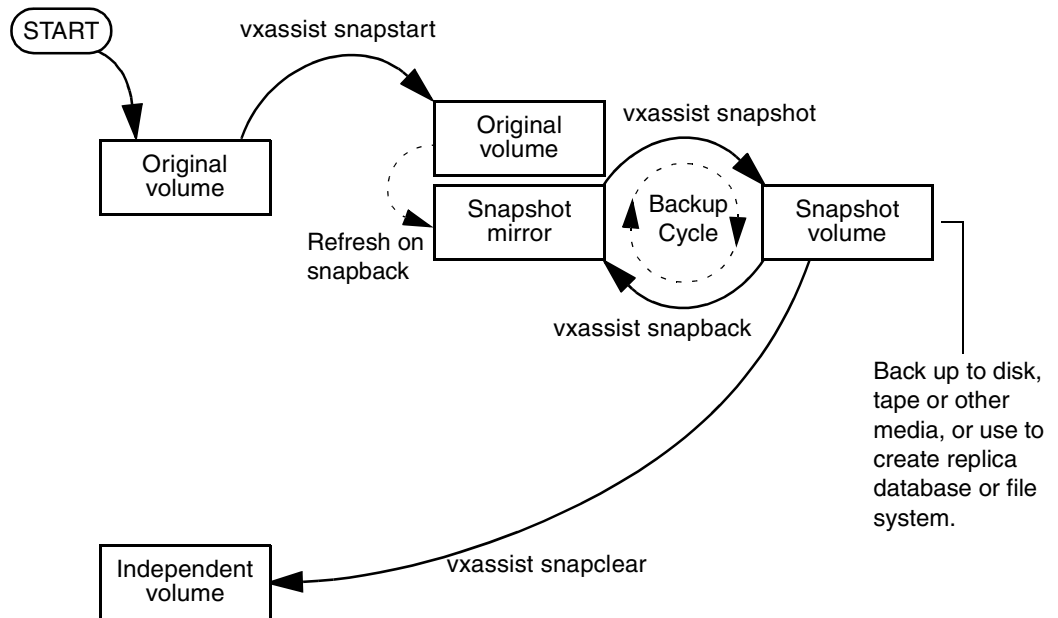

The `vxassist snapstart` command creates a mirror to be used for the snapshot, and attaches it to the volume as a snapshot mirror. (The `vxassist snapabort` command can be used to cancel this operation and remove the snapshot mirror.)

Note As is usual when creating a mirror, the process of copying the volume’s contents to the new snapshot plexes can take some time to complete. For methods of making snapshot plexes immediately available, see “[Full-Sized Instant Snapshots](#)” on page 265 and “[Space-Optimized Instant Snapshots](#)” on page 267.

When the attachment is complete, the `vxassist snapshot` command is used to create a new snapshot volume by taking one or more snapshot mirrors to use as its data plexes. The snapshot volume contains a copy of the original volume’s data at the time that you took the snapshot. If more than one snapshot mirror is used, the snapshot volume is itself mirrored.



The command, `vxassist snapback`, can be used to return snapshot plexes to the original volume from which they were snapped, and to resynchronize the data in the snapshot mirrors from the data in the original volume. This enables you to refresh the data in a snapshot after each time that you use it to make a backup. You can also use a variation of the same command to restore the contents of the original volume from a snapshot that you took at an earlier point in time. See [“Restoring the Original Volume from a Snapshot”](#) on page 274 for more information.

As described in [“FastResync”](#) on page 49, you can use the FastResync feature of VxVM to minimize the time needed to resynchronize the data in the snapshot mirror. If FastResync is not enabled, a full resynchronization of the data is required.

Finally, you can use the `vxassist snapclear` command to break the association between the original volume and the snapshot volume. The snapshot volume then has an existence that is independent of the original volume. This is useful for applications that do not require the snapshot to be resynchronized with the original volume.

Note The use of the `vxassist` command to administer traditional (third-mirror break-off) snapshots is not supported for volumes that are prepared for instant snapshot creation. Instead, the `vxsnap` command may be used as described in the following section.

See [“Creating Traditional Third-Mirror Break-Off Snapshots”](#) on page 299 for a description of the procedures for creating and using this type of snapshot.

Full-Sized Instant Snapshots

Full-sized instant snapshots are a variation on the third-mirror volume snapshot model that make a snapshot volume available for access as soon as the snapshot plexes have been created. The full-sized instant volume snapshot model is illustrated in “[Full-Sized Instant Snapshot Creation and Usage in a Backup Cycle.](#)”

Full-Sized Instant Snapshot Creation and Usage in a Backup Cycle

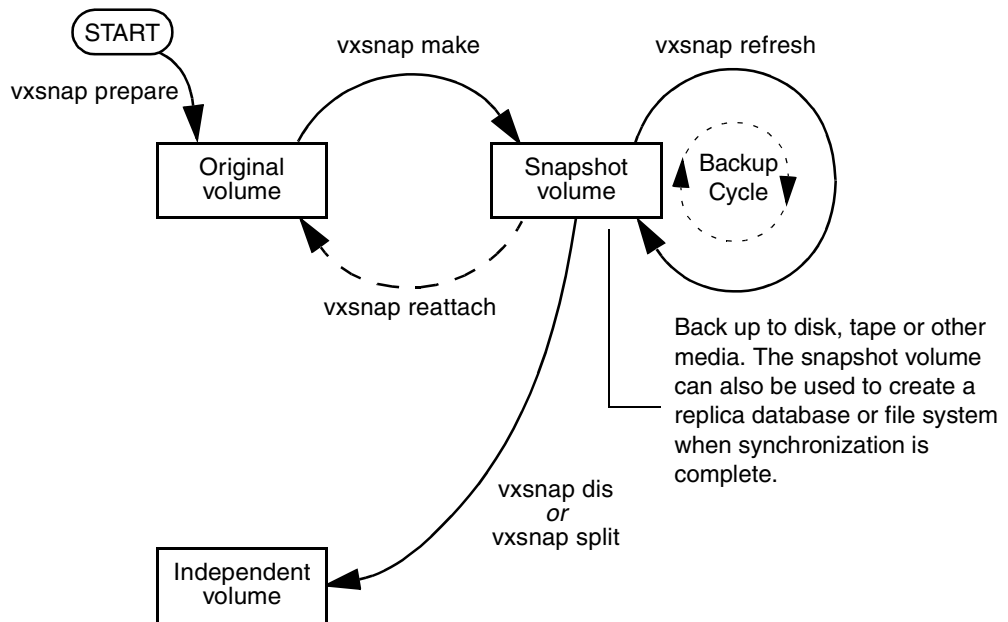

To create an instant snapshot, you use the `vxsnap make` command. This command can either be applied to a suitably prepared empty volume that is to be used as the snapshot volume, or it can be used to break off one or more synchronized plexes from the original volume (which is similar to the way that the `vxassist` command creates its snapshots).

Unlike a third-mirror break-off snapshot created using the `vxassist` command, you can make a backup of a full-sized instant snapshot, instantly refresh its contents from the original volume, or attach its plexes to the original volume, without needing to completely synchronize the snapshot plexes from the original volume.

VxVM uses a *copy-on-write* mechanism to ensure that the snapshot volume preserves the contents of the original volume at the time that the snapshot is taken. Any time that the original contents of the volume are about to be overwritten, the original data in the



volume is preserved on the snapshot volume before the write proceeds. As time goes by, and the contents of the volume are updated, its original contents are gradually relocated to the snapshot volume.

If desired, you can additionally select to perform either a background (non-blocking) or foreground (blocking) synchronization of the snapshot volume. This is useful if you intend to move the snapshot volume into a separate disk group for off-host processing, or you want to use the `vxsnap dis` or `vxsnap split` commands to turn the snapshot volume into an independent volume.

The `vxsnap refresh` command allows you to update the data in a snapshot each time that you make a backup.

The command, `vxsnap reattach`, can be used to attach snapshot plexes to the original volume, and to resynchronize the data in these plexes from the original volume.

Alternatively, you can use the `vxsnap restore` command to restore the contents of the original volume from a snapshot that you took at an earlier point in time. You can also choose whether or not to keep the snapshot volume after restoration of the original volume is complete. See [“Restoring the Original Volume from a Snapshot”](#) on page 274 for more information.

By default, the `FastResync` feature of VxVM is used to minimize the time needed to resynchronize the data in the snapshot mirror. If `FastResync` is not enabled, a full resynchronization of the data is required. For details, see [“FastResync”](#) on page 49.

See [“Creating Instant Snapshots”](#) on page 275 for details of the procedures for creating and using this type of snapshot.

For information about how to prepare an empty volume for use by full-sized instant snapshots, see [“Creating a Volume for Use as a Full-Sized Instant Snapshot”](#) on page 293.

Space-Optimized Instant Snapshots

Volume snapshots, such as those described in “[Traditional Third-Mirror Break-Off Snapshots](#)” on page 263 and “[Full-Sized Instant Snapshots](#)” on page 265, require the creation of a complete copy of the original volume, and use as much storage space as the original volume.

Instead of requiring a complete copy of the original volume’s storage space, *space-optimized* instant snapshots use a storage cache. The size of this cache may be configured when the snapshot is created.

Note A storage cache may be named and shared among several volumes in the same disk group. If so, the size of the cache that is declared must be the same for each volume’s space-optimized snapshot. You may find it convenient to configure a single storage cache in a disk group that can be shared by all the volumes in that disk group. See “[Creating a Shared Cache Object](#)” on page 294 for details.

When the original volume is written to, VxVM preserves the original data contents in the cache before the write is committed. As the storage cache can be configured to require much less storage than the original volume, it is referred to as being *space-optimized*. If the cache becomes too full, you can configure VxVM to grow the size of the cache automatically using any available free space in the disk group.

The instant space-optimized snapshot model is illustrated in “[Space-Optimized Instant Snapshot Creation and Usage in a Backup Cycle](#).”

Space-Optimized Instant Snapshot Creation and Usage in a Backup Cycle

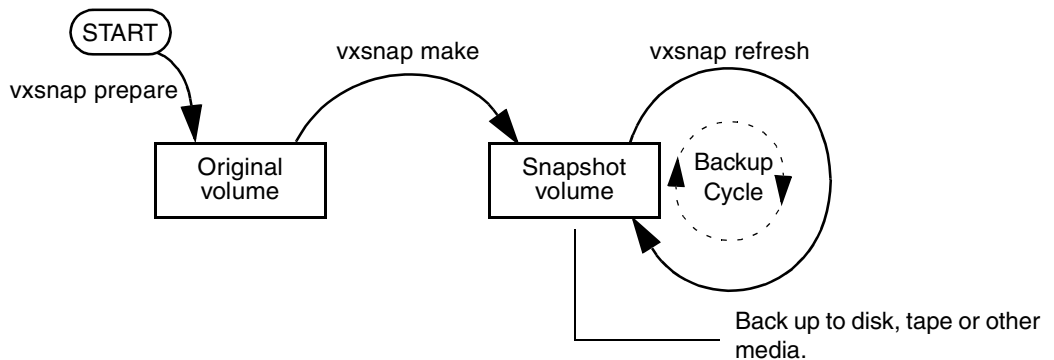

As for instant snapshots, space-optimized snapshots use a copy-on-write mechanism to make them immediately available for use when they are first created, or when their data is refreshed. Unlike instant snapshots, however, you cannot enable synchronization on space-optimized snapshots, reattach them to their original volume, or turn them into independent volumes.

See [“Creating Instant Snapshots”](#) on page 275 for details of the procedures for creating and using this type of snapshot.

For information about how to set up a cache for use by space-optimized instant snapshots, see [“Creating a Shared Cache Object”](#) on page 294.

Emulation of Third-Mirror Break-Off Snapshots

Third-mirror break-off snapshots are suitable for write-intensive volumes (such as for database redo logs) where the copy-on-write mechanism of space-optimized or full-sized instant snapshots might degrade the performance of the volume.

If you use the `vxsnap prepare` command to enable a volume for use with instant and space-optimized snapshots, you cannot use the `vxassist` snapshot commands to administer snapshots that you create for the volume. If you require snapshots that behave as third-mirror break-off snapshots (that is, they must be fully synchronized before they can be used), there are three ways to achieve this:

- ◆ Use the `vxsnap addmir` command to create and attach one or more snapshot mirrors to the volume. When the plexes have been synchronized and are in the `SNAPDONE` state, the `vxsnap make` command can then be used with the `nmirror` attribute to create the snapshot volume. This is similar to using the `vxassist snapstart` and `vxassist snapshot` commands that are described in [“Traditional Third-Mirror Break-Off Snapshots”](#) on page 263.
- ◆ Use the `vxsnap make` command with the `plex` attribute to use one or more existing plexes of a volume as snapshot plexes. The volume must have a sufficient number of available plexes that are in the `ACTIVE` state.

Note The volume must be a non-layered volume with a `mirror` or `mirror-stripe` layout, or a RAID-5 volume that you have converted to a special layered volume (see [“Using a DCO and DCO Volume with a RAID-5 Volume”](#) on page 237) and then mirrored.

The plexes in a volume with a `stripe-mirror` layout are mirrored at the sub-volume level, and cannot be broken off.

- ◆ Use the `vxsnap make` command with the `sync=yes` and `type=full` attributes specified to create the snapshot volume, and then use the `vxsnap syncwait` command to wait for synchronization of the snapshot volume to complete.



See “[Creating Instant Snapshots](#)” on page 275 for details of the procedures for creating and using this type of snapshot.

For information about how to add snapshot mirrors to a volume, see “[Adding Snapshot Mirrors to a Volume](#)” on page 285.

Cascaded Snapshots

A snapshot hierarchy known as a *snapshot cascade* can improve write performance for some applications. Instead of having several independent snapshots of the volume, it is more efficient to make the older snapshots into children of the latest snapshot as shown in “[Snapshot Cascade](#).”

Snapshot Cascade

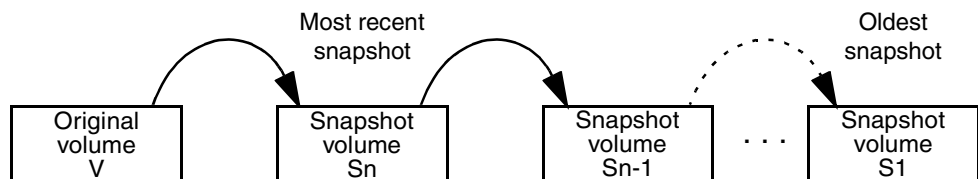

A snapshot may be added to a cascade by specifying the `infrontof` attribute to the `vxsnap make` command when the second and subsequent snapshots in the cascade are created. Changes to blocks in the original volume are only written to the most recently created snapshot volume in the cascade. If an attempt is made to read data from an older snapshot that does not exist in that snapshot, it is obtained by searching recursively up the hierarchy of more recent snapshots.

A snapshot cascade is most likely to be used for regular online backup of a volume where space-optimized snapshots are written to disk but not to tape.

A snapshot cascade improves write performance over the alternative of several independent snapshots, and also requires less disk space if the snapshots are space-optimized. Only the latest snapshot needs to be updated when the original volume is updated. If and when required, the older snapshots can obtain the changed data from the most recent snapshot.

The following points determine whether it is appropriate for an application to use a snapshot cascade:

- ◆ Deletion of a snapshot in the cascade takes time to copy the snapshot’s data to the next snapshot in the cascade.



- ◆ The reliability of a snapshot in the cascade depends on all the newer snapshots in the chain. Thus the oldest snapshot in the cascade is the most vulnerable.
- ◆ Reading from a snapshot in the cascade may require data to be fetched from one or more other snapshots in the cascade.

For these reasons, it is recommended that you do not attempt to use a snapshot cascade with applications that need to remove or split snapshots from the cascade. In such cases, it may be more appropriate to create a snapshot of a snapshot as described in the following section.

See “[Adding a Snapshot to a Cascaded Snapshot Hierarchy](#)” on page 286 for an example of the use of the `infrontof` attribute.

Note Only unsynchronized full-sized or space-optimized instant snapshots are usually cascaded. It is of little utility to create cascaded snapshots if the `infrontof` snapshot volume is fully synchronized (as, for example, with break-off type snapshots).

Creating a Snapshot of a Snapshot

For some applications, it may be desirable to create a snapshot of an existing snapshot as illustrated in “[Creating a Snapshot of a Snapshot](#).”

Creating a Snapshot of a Snapshot

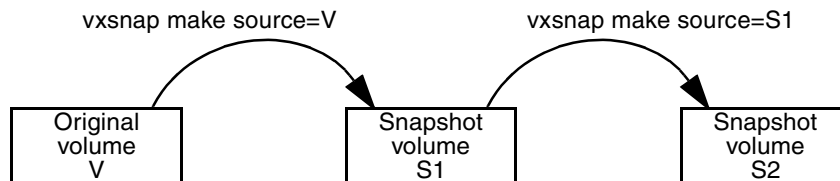

Even though the arrangement of the snapshots in this figure appears similar to the snapshot hierarchy shown in “[Snapshot Cascade](#)” on page 269, the relationship between the snapshots is not recursive. When reading from the snapshot S2, data is obtained directly from the original volume, V, if it does not exist in S2 itself.

Such an arrangement may be useful if the snapshot volume, S1, is critical to the operation. For example, S1 could be used as a stable copy of the original volume, V. The additional snapshot volume, S2, can be used to restore the original volume if that volume becomes corrupted. For a database, you might need to replay a redo log on S2 before you could use it to restore V. These steps are illustrated in “[Using a Snapshot of a Snapshot to Restore a Database](#)” on page 271.

Using a Snapshot of a Snapshot to Restore a Database

1. Create instant snapshot S1 of volume V

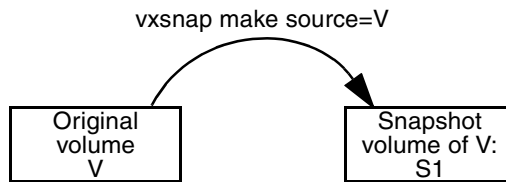

2. Create instant snapshot S2 of snapshot S1

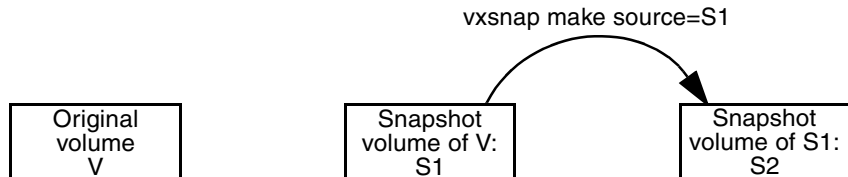

3. After contents of volume V have gone bad, apply the database redo logs to snapshot S2

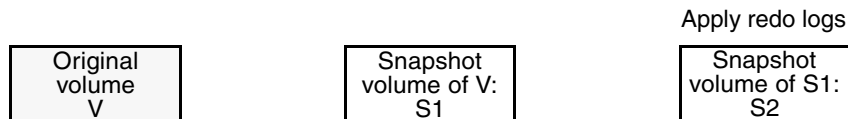

4. Restore contents of volume V instantly from snapshot S2 and retain S1 as a stable copy

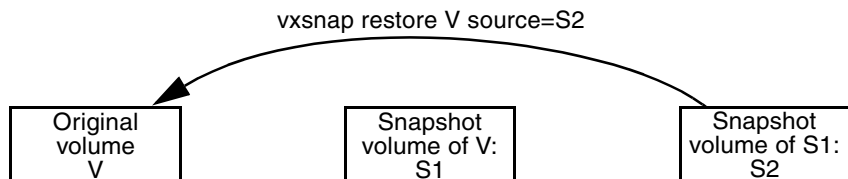

If you have configured snapshots in this way, you may wish to make one or more of the snapshots into independent volumes. There are two `vxsnap` commands that you can use to do this:

- ◆ `vxsnap dis` dissociates a snapshot volume and turns it into an independent volume. The volume to be dissociated must have been fully synchronized from its parent. If a snapshot volume has a child snapshot volume, the child must also have been fully synchronized. If the command succeeds, the child snapshot becomes a snapshot of the original volume. “[Dissociating a Snapshot Volume](#)” on page 272 illustrates the effect of applying this command to snapshots with and without dependent snapshots.

Dissociating a Snapshot Volume

`vxsnap dis` is applied to snapshot S2, which has no snapshots of its own

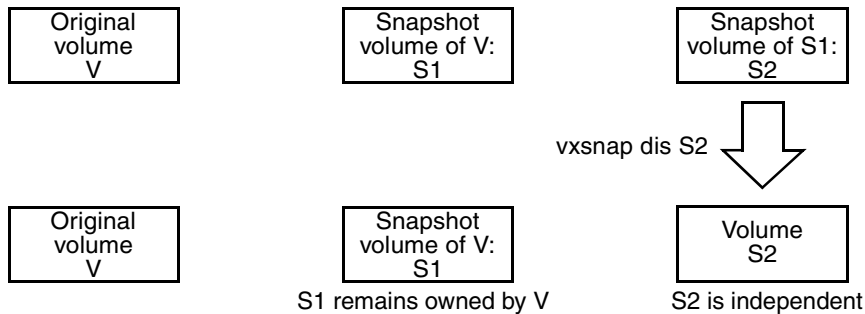

`vxsnap dis` is applied to snapshot S1, which has one snapshot S2

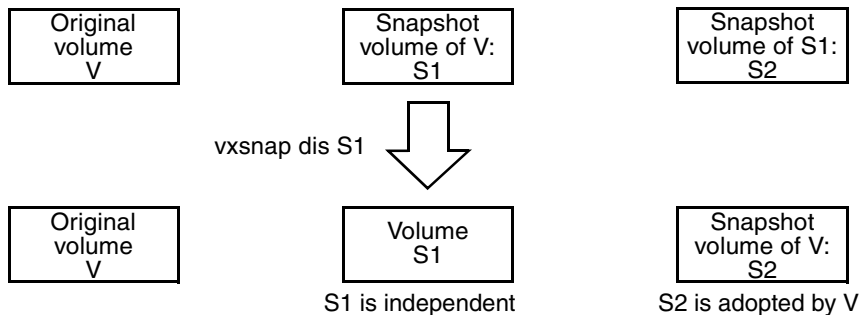

- ◆ `vxsnap split` dissociates a snapshot and its dependent snapshots from its parent volume. The snapshot volume that is to be split must have been fully synchronized from its parent volume. This operation is illustrated in “[Splitting Snapshots](#).”

Splitting Snapshots

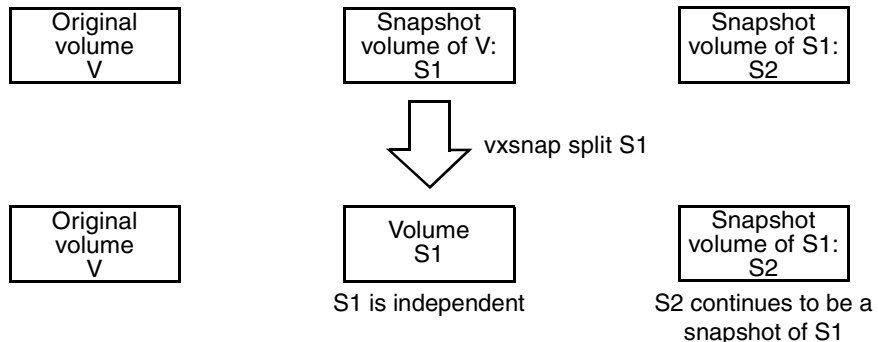

Creating Multiple Snapshots

To make it easier to create snapshots of several volumes at the same time, both the `vxsnap make` and `vxassist snapshot` commands accept more than one volume name as their argument.

For traditional snapshots, you can create snapshots of all the volumes in a single disk group by specifying the option `-o allvols` to the `vxassist snapshot` command.

By default, each replica volume is named `SNAPnumber-volume`, where `number` is a unique serial number, and `volume` is the name of the volume for which a snapshot is being taken. This default can be overridden by using the option `-o name=pattern`, as described on the `vxsnap(1M)` and `vxassist(1M)` manual pages.

It is also possible to take several snapshots of the same volume. A new FastResync change map is produced for each snapshot taken to minimize the resynchronization time for each snapshot.



Restoring the Original Volume from a Snapshot

For traditional snapshots, the snapshot plex is resynchronized from the data in the original volume during a `vxassist snapback` operation. Alternatively, you can choose the snapshot plex as the preferred copy of the data when performing a snapback as illustrated in “[Resynchronizing an Original Volume from a Snapshot](#).” Specifying the option `-o resyncfromreplica` to `vxassist resync` resynchronizes the original volume from the data in the snapshot.

Resynchronizing an Original Volume from a Snapshot

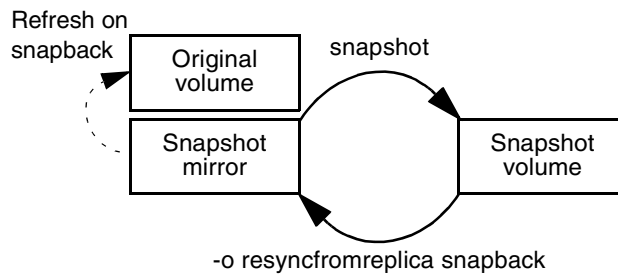

Note The original volume must not be in use during a snapback operation that specifies the option `-o resyncfromreplica` to resynchronize the volume from a snapshot. Stop any application, such as a database, and unmount any file systems that are configured to use the volume.

For instant snapshots, the `vxsnap restore` command may be used to restore the contents of the original volume from an instant snapshot or from a volume derived from an instant snapshot. The volume that is used to restore the original volume can either be a true backup of the contents of the original volume at some point in time, or it may have been modified in some way (for example, by applying a database log replay or by running a file system checking utility such as `fsck`) to create a *synthetic replica*. All synchronization of the contents of this backup or synthetic replica volume must have been completed before the original volume can be restored from it. The original volume is immediately available for use while its contents are being restored.

Note You can perform either a destructive or non-destructive restoration of an original volume from an instant snapshot. Only non-destructive restoration is possible from a space-optimized snapshot. In this case, the snapshot remains in existence after the restoration is complete.

Creating Instant Snapshots

Note You need a full license and a VERITAS FlashSnap™ license to use this feature.

VxVM allows you to make instant snapshots of volumes by using the `vxsnap` command.

Note The information in this section also applies to RAID-5 volumes that have been converted to a special layered volume layout by the addition of a DCO and DCO volume. See [“Using a DCO and DCO Volume with a RAID-5 Volume”](#) on page 237 for details.

A plex in a full-sized instant snapshot requires as much space as the original volume. If you instead make a space-optimized instant snapshot of a volume, this only requires enough storage to record the original contents of the parent volume as they are changed during the life of the snapshot.

The recommended approach to performing volume backup from the command line, or from a script, is to use the `vxsnap` command. The `vxsnap prepare` and `make` tasks allow you to back up volumes online with minimal disruption to users.

The `vxsnap prepare` step creates a DCO and DCO volume and associates this with the volume. It also enables Persistent FastResync on the volume.

The `vxsnap make` step creates an instant snapshot that is immediately available for making a backup. After the snapshot has been taken, read requests for data in the original volume are satisfied by reading either from a non-updated region of the original volume, or from the copy of the original contents of an updated region that have been recorded by the snapshot.

Note Synchronization of a full-sized instant snapshot from the original volume is enabled by default. If you specify the `syncing=no` attribute to `vxsnap make`, this disables synchronization, and the contents of the instant snapshot are unlikely ever to become fully synchronized with the contents of the original volume at the point in time that the snapshot was taken. If you wish to move an instant snapshot volume to another disk group for export to another machine for off-host processing, or to turn it into an independent volume, you must ensure that the snapshot volume has been completely synchronized.

You can immediately retake a full-sized or space-optimized instant snapshot at any time by using the `vxsnap refresh` command. If a fully synchronized instant snapshot is required, you must wait for the new resynchronization to complete.

You can create instant snapshots of volume sets by replacing volume names with volume set names in the `vxsnap` command. For more information, see [“Creating Instant Snapshots of Volume Sets”](#) on page 284.



To back up a volume with the `vxsnap` command, use the following procedure:

1. If you intend to take a space-optimized instant snapshot of the volume, you may wish to consider first setting up a shared cache object in the same disk group as the volume. This cache object can be maintained by using the `vxcache` command.

See [“Creating a Shared Cache Object”](#) on page 294 for details of how to set up a shared cache object.

Note If you intend to split the volume and snapshot into separate disk groups (for example, to perform off-host processing), you must use a fully synchronized full-sized instant snapshot (which does not require a cache object). You cannot use a space-optimized instant snapshot for this purpose.

2. Use the following commands on the primary host to see if the volume is associated with a version 20 data change object (DCO) and DCO volume that allow instant snapshots and Persistent FastResync to be used with the volume, and to check that FastResync is enabled on the volume:

```
# vxprint -g volumedg -F%instant volume
# vxprint -g volumedg -F%fastresync volume
```

If both these command return a value of `on`, the volume can be used for instant snapshot operations.

To prepare a volume for instant snapshots, use the following command:

```
# vxsnap [-g diskgroup] prepare volume [regionsize=size] \
  [ndcomirs=number] [alloc=storage_attributes]
```

Note It is only necessary to run the `vxsnap prepare` command on a volume if it does not already have a version 20 DCO volume (for example, if you have run the `vxsnap unprepare` command on the volume). See [“Creating a Volume with a Version 20 DCO Volume”](#) on page 212, [“Preparing a Volume for DRL and Instant Snapshots”](#) on page 235 and [“Removing Support for DRL and Instant Snapshots from a Volume”](#) on page 239 for more information.

For example, to prepare the volume, `myvol`, in the disk group, `mydg`, use the following command:

```
# vxsnap -g mydg prepare myvol regionsize=128k ndcomirs=2 \
  alloc=mydg10,mydg11
```

This example creates a DCO object and redundant DCO volume with two plexes located on disks `mydg10` and `mydg11`, and associates them with `myvol`. The region size is also increased to 128KB from the default size of 64KB. The region size must be a

power of 2, and be greater than or equal to 16KB. A smaller value requires more disk space for the change maps, but the finer granularity provides faster resynchronization.

For space-optimized instant snapshots that share a cache object, the specified region size must be greater than or equal to the region size specified for the cache object. See [“Creating a Shared Cache Object”](#) on page 294 for details.

Note Creation of space-optimized snapshots that use a shared cache fails if the region size specified for the volume is smaller than the region size set on the cache.

If the region size of a space-optimized snapshot differs from the region size of the cache, this can degrade the system’s performance compared to the case where the region sizes are the same.

When using the `vxsnap prepare` or `vxassist make` commands to make a volume ready for instant snapshot operations, if the specified region size exceeds half the value of the tunable `vliomem_maxpool_sz` (see [“vliomem_maxpool_sz”](#) on page 416), the operation succeeds but gives a warning such as the following (for a system where `vliomem_maxpool_sz` is set to 12MB):

```
VxVM vxassist WARNING V-5-1-0 Specified regionsize is larger than
the limit on the system (vliomem_maxpool_sz/2=6144k).
```

`vxsnap make` operations to create full-sized or space-optimized instant snapshots, and `refresh` and `restore` operations on such volumes fail as they might potentially hang the system. Such volumes can be used only for breakoff-type snapshot operations using the `reattach` and `make` operations.

To make the volumes usable for instant snapshot operations, use `vxsnap unprepare` on the volume, and then use `vxsnap prepare` to re-prepare the volume with a region size that is less than half the size of `vliomem_maxpool_sz` (in this example, 1MB):

```
# vxsnap -g mydg -f unprepare voll
# vxsnap -g mydg prepare voll regionsize=1M
```

3. For full-sized instant snapshots, you must create a volume that is to be used as the snapshot volume. This must be the same size as the volume for which the snapshot is being created, and it must also have the same region size. See [“Creating a Volume for Use as a Full-Sized Instant Snapshot”](#) on page 293 for details.

Alternatively, if there is a sufficient number of suitable plexes available in the volume, you can break these off and use them to create a full-sized instant snapshot. You can either use existing `ACTIVE` plexes in the volume, or you can use the following command to add new snapshot mirrors to the volume:



```
# vxsnap [-b] [-g diskgroup] addmir volume [nmirror=N] \  
[alloc=storage_attributes]
```

By default, the `vxsnap addmir` command adds one snapshot mirror to a volume unless you use the `nmirror` attribute to specify a different number of mirrors. The mirrors remain in the `SNAPATT` state until they are fully synchronized. The `-b` option can be used to perform the synchronization in the background. Once synchronized, the mirrors are placed in the `SNAPDONE` state.

For example, the following command adds 2 mirrors to the volume, `vol1`, on disks `mydg10` and `mydg11`:

```
# vxsnap -g mydg addmir vol1 nmirror=2 alloc=mydg10,mydg11
```

Note To turn one or more existing plexes in a volume into a break-off instant snapshot volume, the volume must be a non-layered volume with a `mirror` or `mirror-stripe` layout, or a RAID-5 volume that you have converted to a special layered volume (see [“Using a DCO and DCO Volume with a RAID-5 Volume”](#) on page 237) and then mirrored. The plexes in a volume with a `stripe-mirror` layout are mirrored at the sub-volume level, and cannot be broken off.

4. Use the `vxsnap make` step to create an instant snapshot that is immediately available for making a backup. If you specify a name and size for a storage cache, a space-optimized snapshot is created that requires less space than does a full-sized snapshot volume.

Depending on the type of instant snapshot that you require, there are three main variants on the `vxsnap make` command that you can issue:

- ❖ To create a full-sized instant snapshot, use one of the following forms of the `vxsnap make` command:

```
# vxsnap [-g diskgroup] make source=volume/snapvol=snapvol \  
[/syncing=off]
```

```
# vxsnap [-g diskgroup] make source=volume[/newvol=snapvol] \  
{/plex=plex1[,plex2,...] | /nmirror=number]
```

Note The attributes for a snapshot are specified as a tuple. The `vxsnap make` command accepts multiple tuples; one for each snapshot that is being created. A tuple for a full-sized instant snapshot must contain a `source` attribute and a `snapvol` attribute. Each element of a tuple is separated from the next by a slash character (/). Tuples are separated by white space.

The first form of the command specifies an existing volume, *snapvol*, that is to be used as the snapshot volume. See “[Creating a Volume for Use as a Full-Sized Instant Snapshot](#)” on page 293 for details.

For example, to use the prepared volume, *snap1myvol*, as the snapshot for the volume, *myvol*, in the disk group, *mydg*, use the following command:

```
# vxsnap -g mydg make source=myvol/snapvol=snap1myvol
```

For full-size instant snapshots that are created from an empty volume, background synchronization is enabled by default (equivalent to specifying the `syncing=on` attribute). If you want to move a snapshot into a separate disk group, or to turn it into an independent volume, you must wait for its contents to be synchronized with those of its parent volume.

You can use the `vxsnap syncwait` command to wait for the synchronization of the snapshot volume to be completed, as shown here:

```
# vxsnap [-g diskgroup] syncwait snapvol
```

For example, you would use the following command to wait for synchronization to finish on the snapshot volume, *snap2myvol*:

```
# vxsnap -g mydg syncwait snap2myvol
```

This command exits (with a return code of zero) when synchronization of the snapshot volume is complete. The snapshot volume may then be moved to another disk group or turned into an independent volume.

If required, you can use the following command to verify whether the `V_PFLAG_INCOMPLETE` flag is set on a volume:

```
# vxprint [-g diskgroup] -F%incomplete snapvol
```

This command returns the value `off` if synchronization of the volume, *snapvol*, is complete; otherwise, it returns the value `on`.

You can also use the `vxsnap print` command to check on the progress of synchronization as described in “[Displaying Instant Snapshot Information \(vxsnap print\)](#)” on page 291.

See “[Controlling Instant Snapshot Synchronization](#)” on page 292 for more information.

If you do not want to move the snapshot into a separate disk group, or to turn it into an independent volume, specify the `syncing=off` attribute. This avoids creating unnecessary system overhead. For example, to turn off synchronization when creating the snapshot of the volume, *myvol*, you would use the following form of the `vxsnap make` command:

```
# vxsnap -g mydg make source=myvol/snapvol=snap1myvol/syncing=off
```



The second form of the `vxsnap make` command uses one of the following attributes to create the new snapshot volume, *snapvol*, by breaking off one or more existing plexes in the original volume:

- `plex` Specifies the plexes in the existing volume that are to be broken off. This attribute can only be used with plexes that are in the ACTIVE state.
- `nmirror` Specifies how many plexes are to be broken off. This attribute can only be used with plexes that are in the SNAPDONE state. (That is, they have been added to the volume by using the `vxsnap addmir` command.)

Snapshots that are created from one or more ACTIVE or SNAPDONE plexes in the volume are already synchronized by definition.

For backup purposes, a snapshot volume with one plex should be sufficient.

Note Break-off snapshots are suitable for write-intensive volumes (such as for database redo logs) where the copy-on-write mechanism of space-optimized or full-sized instant snapshots might degrade the performance of the volume.

Snapshots that you create by using `vxsnap` to detach existing plexes in the volume are functionally equivalent to the traditional third-mirror break-off snapshots that you can create by using `vxassist`. As future releases may not support this functionality in `vxassist`, it is recommended that you use `vxsnap` to create this type of snapshot.

For example, to create the instant snapshot volume, *snap2myvol*, of the volume, *myvol*, in the disk group, *mydg*, from a single existing plex in the volume, use the following command:

```
# vxsnap -g mydg make source=myvol/newvol=snap2myvol/nmirror=1
```

The next example shows how to create a mirrored snapshot from two existing plexes in the volume:

```
# vxsnap -g mydg make source=myvol/newvol=snap2myvol\  
/plex=myvol-03,myvol-04
```

- ❖ To create a space-optimized instant snapshot, *snapvol*, that uses a named shared cache object:

```
# vxsnap [-g diskgroup] make source=vol/newvol=snapvol\  
/[cache=cacheobject] [alloc=storage_attributes]
```

For example, to create the space-optimized instant snapshot, *snap3myvol*, of the volume, *myvol*, in the disk group, *mydg*, on the disk *mydg14*, and which uses the shared cache object, *cobjmydg*, use the following command:

```
# vxsnap -g mydg make source=myvol/newvol=snap3myvol\  
/cache=cobjmydg alloc=mydg14
```

For details of how to create a shared cache object, see “[Creating a Shared Cache Object](#)” on page 294.

- ❖ To create a space-optimized instant snapshot, *snapvol*, and also create a cache object for it to use:

```
# vxsnap [-g diskgroup] make source=vol/newvol=snapvol\  
[/cachesize=size] [/autogrow=yes] [/ncachemirror=number]\  
[alloc=storage_attributes]
```

The *cachesize* attribute determines the size of the cache relative to the size of the volume. The *autogrow* attribute determines whether VxVM will automatically enlarge the cache if it is in danger of overflowing. By default, the cache is not grown.

Note If *autogrow* is enabled, but the cache cannot be grown, VxVM disables the oldest and largest snapshot that is using the same cache, and releases its cache space for use.

The *ncachemirror* attribute specifies the number of mirrors to create in the cache volume. For backup purposes, the default value of 1 should be sufficient.

For example, to create the space-optimized instant snapshot, *snap4myvol*, of the volume, *myvol*, in the disk group, *mydg*, on the disk *mydg15*, and which uses a newly allocated cache object that is 1GB in size, but which can automatically grow in size, use the following command:

```
# vxsnap -g mydg make source=myvol/new=snap4myvol/cachesize=1g\  
/autogrow=yes alloc=mydg15
```

Note If a cache is created implicitly by specifying *cachesize*, and *ncachemirror* is specified to be greater than 1, a DCO is attached to the cache volume to enable dirty region logging (DRL). DRL allows fast recovery of the cache backing store after a system crash. The DCO is allocated on the same disks as those that are occupied by the DCO of the source volume. This is done to allow the cache and the source volume to remain in the same disk group for disk group move, split and join operations.

5. Use *fsck* (or some utility appropriate for the application running on the volume) to clean the temporary volume’s contents. For example, you can use this command with a VxFS file system:

```
# fsck -F vxfs /dev/vx/rdsk/diskgroup/snapshot
```

6. If you require a backup of the data in the snapshot, use an appropriate utility or operating system command to copy the contents of the snapshot to tape, or to some other backup medium.



You have the following choices of what to do with an instant snapshot:

- ◆ Refresh the contents of the snapshot. This creates a new point-in-time image of the original volume ready for another backup. If synchronization was already in progress on the snapshot, this operation may result in large portions of the snapshot having to be resynchronized. See “[Refreshing an Instant Snapshot \(vxsnap refresh\)](#)” on page 287 for details.
- ◆ Reattach some or all of the plexes of the snapshot volume with the original volume. See “[Reattaching an Instant Snapshot \(vxsnap reattach\)](#)” on page 287 for details.

Note The `reattach` operation is not supported for space-optimized instant snapshots.

- ◆ Restore the contents of the original volume from the snapshot volume. For full-sized instant snapshots, you can choose whether none, a subset, or all of the plexes of the snapshot volume are returned to the original volume as a result of the operation. A space-optimized instant snapshot always remains intact at the end of the operation. See “[Restoring a Volume from an Instant Snapshot \(vxsnap restore\)](#)” on page 288 for details.
- ◆ Dissociate the snapshot volume entirely from the original volume. This may be useful if you want to use the copy for other purposes such as testing or report generation. If desired, you can delete the dissociated volume. See “[Dissociating an Instant Snapshot \(vxsnap dis\)](#)” on page 289 for details.

Note For space-optimized instant snapshots, this operation is only useful if you then want to delete the snapshot altogether.

- ◆ If the snapshot is part of a snapshot hierarchy, you can also choose to split this hierarchy from its parent volumes. See “[Splitting an Instant Snapshot Hierarchy \(vxsnap split\)](#)” on page 290 for details.

Note This operation is not supported for space-optimized instant snapshots.

Creating Multiple Instant Snapshots

To make it easier to create snapshots of several volumes at the same time, the `vxsnap` make command accepts multiple tuples that define the source and snapshot volumes names as their arguments. For example, to create three instant snapshots, each with the same redundancy, from specified storage, the following form of the command can be used:

```
# vxsnap [-g diskgroup] make source=vol1/snapvol=snapvol1\  
source=vol2/snapvol=snapvol2 source=vol3/snapvol=snapvol3
```

The snapshot volumes (*snapvol1*, *snapvol2* and so on) must have been prepared in advance as described in “[Creating a Volume for Use as a Full-Sized Instant Snapshot](#)” on page 293. The specified source volumes (*vol1*, *vol2* and so on) may be the same volume or they can be different volumes.

If all the snapshots are to be space-optimized and to share the same cache, the following form of the command can be used:

```
# vxsnap [-g diskgroup] make \  
source=vol1/newvol=snapvol1/cache=cacheobj \  
source=vol2/newvol=snapvol2/cache=cacheobj \  
source=vol3/newvol=snapvol3/cache=cacheobj \  
[alloc=storage_attributes]
```

The `vxsnap` make command also allows the snapshots to be of different types, have different redundancy, and be configured from different storage, as shown here:

```
# vxsnap [-g diskgroup] make source=vol1/snapvol=snapvol1 \  
source=vol2[/newvol=snapvol2]/cache=cacheobj\  
[/alloc=storage_attributes2] [/nmirror=number2]  
source=vol3[/newvol=snapvol3] [/alloc=storage_attributes3] \  
/nmirror=number3
```

In this example, *snapvol1* is a full-sized snapshot that uses a prepared volume, *snapvol2* is a space-optimized snapshot that uses a prepared cache, and *snapvol3* is a break-off full-sized snapshot that is formed from plexes of the original volume.

An example of where you might want to create mixed types of snapshots at the same time is when taking snapshots of volumes containing database redo logs and database tables:

```
# vxsnap -g mydg make \  
source=logv1/newvol=snplogv1/drl=sequential/nmirror=1 \  
source=logv2/newvol=snplogv2/drl=sequential/nmirror=1 \  
source=datav1/newvol=snpdatav1/cache=mydgcobj/drl=on \  
source=datav2/newvol=snpdatav2/cache=mydgcobj/drl=on
```



In this example, sequential DRL is enabled for the snapshots of the redo log volumes, and normal DRL is applied to the snapshots of the volumes that contain the database tables. The two space-optimized snapshots are configured to share the same cache object in the disk group. Also note that break-off snapshots are used for the redo logs as such volumes are write intensive.

Creating Instant Snapshots of Volume Sets

Volume set names can be used in place of volume names with the following `vxvset` operations on instant snapshots: `addmir`, `dis`, `make`, `prepare`, `reattach`, `refresh`, `restore`, `rmmir`, `split`, `syncpause`, `syncresume`, `syncstart`, `syncstop`, `syncwait`, and `unprepare`.

The procedure for creating an instant snapshot of a volume set is the same as that for a standalone volume. However, there are certain restrictions if a full-sized instant snapshot is to be created from a prepared volume set. A full-sized instant snapshot of a volume set must itself be a volume set with the same number of volumes, and the same volume sizes and index numbers as the parent. For example, if a volume set contains three volumes with sizes 1GB, 2GB and 3GB, and indexes 0, 1 and 2 respectively, then the snapshot volume set must have three volumes with the same sizes matched to the same set of index numbers. The corresponding volumes in the parent and snapshot volume sets are also subject to the same restrictions as apply between standalone volumes and their snapshots.

You can use the `vxvset list` command to verify that the volume sets have identical characteristics as shown in this example:

```
# vxvset -g mydg list vset1
VOLUME      INDEX      LENGTH      KSTATE      CONTEXT
vol_0        0           204800      ENABLED      -
vol_1        1           409600      ENABLED      -
vol_2        2           614400      ENABLED      -

# vxvset -g mydg list snapvset1
VOLUME      INDEX      LENGTH      KSTATE      CONTEXT
svol_0       0           204800      ENABLED      -
svol_1       1           409600      ENABLED      -
svol_2       2           614400      ENABLED      -
```

A full-sized instant snapshot of a volume set can be created using a prepared volume set in which each volume is the same size as the corresponding volume in the parent volume set. Alternatively, you can use the `nmirrors` attribute to specify the number of plexes that are to be broken off provided that sufficient plexes exist for each volume in the volume set.



The following example shows how to prepare a source volume set, `vset1`, and an identical volume set, `snapvset1`, which is then used to create the snapshot:

```
# vxsnap -g mydg prepare vset1
# vxsnap -g mydg prepare snapvset1
# vxsnap -g mydg make source=vset1/snapvol=snapvset1
```

To create a full-sized third-mirror break-off snapshot, you must ensure that each volume in the source volume set contains sufficient plexes. The following example shows how to achieve this by using the `vxsnap` command to add the required number of plexes before breaking off the snapshot:

```
# vxsnap -g mydg prepare vset2
# vxsnap -g mydg addmir vset2 nmirror=1
# vxsnap -g mydg make source=vset2/newvol=snapvset2/nmirror=1
```

See [“Adding Snapshot Mirrors to a Volume”](#) on page 285 for more information about adding plexes to volumes or to volume sets.

To create a space-optimized instant snapshot of a volume set, the commands are again identical to that for a standalone volume as shown in these examples:

```
# vxsnap -g mydg prepare vset3
# vxsnap -g mydg make source=vset3/newvol=snapvset3/cachesize=20m

# vxsnap -g mydg prepare vset4
# vxsnap -g mydg make source=vset4/newvol=snapvset4/cache=mycobj
```

Here a new cache object is created for the volume set, `vset3`, and an existing cache object, `mycobj`, is used for `vset4`.

See [“Creating and Administering Volume Sets”](#) on page 311 for more information on creating and administering volume sets.

Adding Snapshot Mirrors to a Volume

If you are going to create a full-sized break-off snapshot volume, you can use the following command to add new snapshot mirrors to a volume:

```
# vxsnap [-b] [-g diskgroup] addmir volume|volume_set [nmirror=N] \
  [alloc=storage_attributes]
```

Note The volume must have been prepared using the `vxsnap prepare` command as described in [“Preparing a Volume for DRL and Instant Snapshots”](#) on page 235.

If a volume set name is specified instead of a volume, the specified number of plexes is added to each volume in the volume set.



By default, the `vxsnap addmir` command adds one snapshot mirror to a volume unless you use the `nmirror` attribute to specify a different number of mirrors. The mirrors remain in the `SNAPATT` state until they are fully synchronized. The `-b` option can be used to perform the synchronization in the background. Once synchronized, the mirrors are placed in the `SNAPDONE` state.

For example, the following command adds 2 mirrors to the volume, `vol1`, on disks `mydg10` and `mydg11`:

```
# vxsnap -g mydg addmir vol1 nmirror=2 alloc=mydg10,mydg11
```

Note This command is similar in usage to the `vxassist snapstart` command, and supports the traditional third-mirror break-off snapshot model. As such, it does not provide an instant snapshot capability.

Once you have added one or more snapshot mirrors to a volume, you can use the `vxsnap make` command with either the `nmirror` attribute or the `plex` attribute to create the snapshot volumes.

Removing a Snapshot Mirror from a Volume

To remove a single snapshot mirror from a volume, use this command:

```
# vxsnap [-g diskgroup] rmmir volume|volume_set
```

For example, the following command removes a snapshot mirror from the volume, `vol1`:

```
# vxsnap -g mydg rmmir vol1
```

Note This command is similar in usage to the `vxassist snapabort` command.

If a volume set name is specified instead of a volume, a mirror is removed from each volume in the volume set.

Adding a Snapshot to a Cascaded Snapshot Hierarchy

To create a snapshot and push it onto a snapshot hierarchy between the original volume and an existing snapshot volume, specify the name of the existing snapshot volume as the value of the `infrontof` attribute to the `vxsnap make` command. The following example shows how to place the space-optimized snapshot, `thurs_bu`, of the volume, `dbvol`, in front of the earlier snapshot, `wed_bu`:

```
# vxsnap -g dbdg make source=dbvol/newvol=thurs_bu/\
infrontof=wed_bu/cache=dbdgcache
```

Similarly, the next snapshot that is taken, `fri_bu`, is placed in front of `thurs_bu`:

```
# vxsnap -g dbdg make source=dbvol/newvol=fri_bu/\
infrontof=thurs_bu/cache=dbdgcache
```

For more information on the application of cascaded snapshots, see “[Cascaded Snapshots](#)” on page 269.

Refreshing an Instant Snapshot (vxsnap refresh)

Refreshing an instant snapshot replaces it with another point-in-time copy of a parent volume. To refresh one or more snapshots and make them immediately available for use, use the following command:

```
# vxsnap [-g diskgroup] refresh snapvolume|snapvolume_set \
source=volume|volume_set [[snapvol2 source=vol2]...] \
[syncing=yes|no]
```

If the source volume is not specified, the immediate parent of the snapshot is used. For full-sized instant snapshots, resynchronization is started by default. To disable resynchronization, specify the `syncing=no` attribute. This attribute is not supported for space-optimized snapshots.

Note The snapshot being refreshed must not be open to any application. For example, any file system configured on the volume must first be unmounted.

It is possible to refresh a volume from an unrelated volume provided that their sizes are compatible.

You can use the `vxsnap syncwait` command to wait for the synchronization of the snapshot volume to be completed, as shown here:

```
# vxsnap [-g diskgroup] syncwait snapvol
```

See “[Controlling Instant Snapshot Synchronization](#)” on page 292 for more information.

Reattaching an Instant Snapshot (vxsnap reattach)

Note This operation is not supported for space-optimized instant snapshots.

Using the following command, some or all plexes of an instant snapshot may be reattached to the specified original volume, or to a source volume in the snapshot hierarchy above the snapshot volume:

```
# vxsnap [-g diskgroup] reattach snapvolume|snapvolume_set \
source=volume|volume_set [nmirror=number]
```



By default, all the plexes are reattached, which results in the removal of the snapshot. If required, the number of plexes to be reattached may be specified as the value assigned to the `nmirror` attribute.

Note The snapshot being reattached must not be open to any application. For example, any file system configured on the snapshot volume must first be unmounted.

It is possible to reattach a volume to an unrelated volume provided that their sizes are compatible.

You cannot use the `vxsnap syncwait` command to wait for synchronization of the reattached plexes to complete.

For example the following command reattaches one plex from the snapshot volume, `snapmyvol`, to the volume, `myvol`:

```
# vxsnap -g mydg reattach snapmyvol source=myvol nmirror=1
```

While the reattached plexes are being resynchronized from the data in the parent volume, they remain in the `SNAPTMP` state. After resynchronization is complete, the plexes are placed in the `ACTIVE` state.

Note If the volume and its snapshot have both been resized (to an identical smaller or larger size) before performing the reattachment, a fast resynchronization can still be performed. A full resynchronization is not required. Version 20 DCO volumes are resized proportionately when the associated data volume is resized. For version 0 DCO volumes, the `FastResync` maps stay the same size, but the region size is recalculated, and the locations of the dirty bits in the existing maps are adjusted. In both cases, new regions are marked as dirty in the maps.

Restoring a Volume from an Instant Snapshot (`vxsnap restore`)

It may sometimes be desirable to reinstate the contents of a volume from a backup or modified replica in a snapshot volume. The following command may be used to restore one or more volumes from the specified snapshots:

```
# vxsnap [-g diskgroup] restore volume|volume_set \
  source=snapvolume|snapvolume_set \
  [[volume2|volume_set2 source=snapvolume2|snapvolume_set2]...] \
  [destroy=yes|no] [syncing=yes|no] [nmirror=number]
```

For a full-sized instant snapshot, some or all of its plexes may be reattached to the parent volume or to a specified source volume in the snapshot hierarchy above the snapshot volume. If `destroy=yes` is specified, all the plexes of the full-sized instant snapshot are reattached and the snapshot volume is removed.

For a space-optimized instant snapshot, the cached data is used to recreate the contents of the specified volume. The space-optimized instant snapshot remains unchanged by the restore operation.

Note For this operation to succeed, the volume that is being restored and the snapshot volume must not be open to any application. For example, any file systems that are configured on either volume must first be unmounted.

It is not possible to restore a volume from an unrelated volume.

The `destroy` and `nmirror` attributes are not supported for space-optimized instant snapshots.

The following example demonstrates how to restore the volume, `myvol`, from the space-optimized snapshot, `snap3myvol`.

```
# vxsnap -g mydg restore myvol source=snap3myvol
```

Dissociating an Instant Snapshot (`vxsnap dis`)

The following command breaks the association between a full-sized instant snapshot volume, `snapvol`, and its parent volume, so that the snapshot may be used as an independent volume:

```
# vxsnap [-f] [-g diskgroup] dis snapvolume|snapvolume_set
```

This operation fails if the snapshot, `snapvol`, has a snapshot hierarchy below it that contains unsynchronized snapshots. If this happens, the dependent snapshots must be fully synchronized from `snapvol`. When no dependent snapshots remain, `snapvol` may be dissociated. The snapshot hierarchy is then adopted by `snapvol`'s parent volume.

Note To be usable after dissociation, the snapshot volume and any snapshots in the hierarchy must have been fully synchronized. See “[Controlling Instant Snapshot Synchronization](#)” on page 292 for more information. In addition, you cannot dissociate a snapshot if synchronization of any of the dependent snapshots in the hierarchy is incomplete. If an incomplete snapshot is dissociated, it is unusable and should be deleted as described in “[Removing an Instant Snapshot](#)” on page 290.

The following command dissociates the snapshot, `snap2myvol`, from its parent volume:

```
# vxsnap -g mydg dis snap2myvol
```



Note When applied to a volume set or to a component volume of a volume set, this operation can result in inconsistencies in the snapshot hierarchy in the case of a system crash or hardware failure. If the operation is applied to a volume set, the `-f` (force) option must be specified.

Removing an Instant Snapshot

When you have dissociated a full-sized instant snapshot, you can use the `vxedit` command to delete it altogether, as shown in this example:

```
# vxedit -g mydg -r rm snap2myvol
```

You can also use this command to remove a space-optimized instant snapshot from its cache. For details of how to remove a cache, see [“Removing a Cache”](#) on page 298.

Splitting an Instant Snapshot Hierarchy (vxsnap split)

Note This operation is not supported for space-optimized instant snapshots.

The following command breaks the association between a snapshot hierarchy that has the snapshot volume, *snapvol*, at its head, and its parent volume, so that the snapshot hierarchy may be used independently of the parent volume:

```
# vxsnap [-f] [-g diskgroup] split snapvolume|snapvolume_set
```

Note The topmost snapshot volume in the hierarchy must have been fully synchronized for this command to succeed. Snapshots that are lower down in the hierarchy need not have been fully resynchronized. See [“Controlling Instant Snapshot Synchronization”](#) on page 292 for more information.

The following command splits the snapshot hierarchy under `snap2myvol` from its parent volume:

```
# vxsnap -g mydg split snap2myvol
```

Note When applied to a volume set or to a component volume of a volume set, this operation can result in inconsistencies in the snapshot hierarchy in the case of a system crash or hardware failure. If the operation is applied to a volume set, the `-f` (force) option must be specified.

Displaying Instant Snapshot Information (vxsnap print)

The `vxsnap print` command may be used to display information about the snapshots that are associated with a volume.

```
# vxsnap [-g diskgroup] print [vol]
```

This command shows the percentage progress of the synchronization of a snapshot or volume. If no volume is specified, information about the snapshots for all the volumes in a disk group is displayed. The following example shows a volume, `vol1`, which has a full-sized snapshot, `snapvol1` whose contents have not been synchronized with `vol1`:

```
# vxsnap -g mydg print
```

NAME	SNAPOBJECT	TYPE	PARENT	SNAPSHOT	%DIRTY	%VALID
vol1	--	volume	--	--	--	100
	snapvol1_snp1	volume	--	snapvol1	1.30	--
snapvol1	vol1_snp1	volume	vol1	--	1.30	1.30

The `%DIRTY` value for `snapvol1` shows that its contents have changed by 1.30% when compared with the contents of `vol1`. As `snapvol1` has not been synchronized with `vol1`, the `%VALID` value is the same as the `%DIRTY` value. If the snapshot were partly synchronized, the `%VALID` value would lie between the `%DIRTY` value and 100%. If the snapshot were fully synchronized, the `%VALID` value would be 100%. The snapshot could then be made independent or moved into another disk group.



Controlling Instant Snapshot Synchronization

Note Synchronization of the contents of a snapshot with its original volume is not possible for space-optimized instant snapshots.

By default, synchronization is enabled for the `vxsnap reattach`, `refresh` and `restore` operations on instant snapshots. Otherwise, synchronization is disabled unless you specify the `syncing=yes` attribute to the `vxsnap` command.

The following table shows the commands that are provided for controlling the synchronization manually.

Command	Description
<code>vxsnap [-g <i>diskgroup</i>] syncpause <i>vol vol_set</i></code>	Pause synchronization of a volume.
<code>vxsnap [-g <i>diskgroup</i>] syncresume \ <i>vol vol_set</i></code>	Resume synchronization of a volume.
<code>vxsnap [-b] [-g <i>diskgroup</i>] syncstart \ <i>vol vol_set</i></code>	Start synchronization of a volume. The <code>-b</code> option puts the operation in the background.
<code>vxsnap [-g <i>diskgroup</i>] syncstop <i>vol vol_set</i></code>	Stop synchronization of a volume.
<code>vxsnap [-g <i>diskgroup</i>] syncwait <i>vol vol_set</i></code>	Exit when synchronization of a volume is complete. An error is returned if <i>vol</i> is invalid (for example, it is a space-optimized snapshot), or if <i>vol</i> is not being synchronized.
	Note You cannot use this command to wait for synchronization of reattached plexes to complete.

Improving the Performance of Snapshot Synchronization

Two optional arguments to the `-o` option are provided to help optimize the performance of synchronization when using the `make`, `refresh`, `restore` and `syncstart` operations:

`iosize=size` Specifies the size of each I/O request that is used when synchronizing the regions of a volume. Specifying a larger size causes synchronization to complete sooner, but with greater impact on the performance of other processes that are accessing the



volume. The default *size* of 1m (1MB) is suggested as the minimum value for high-performance array and controller hardware. The specified value is rounded to a multiple of the volume's region size.

`slow=iodelay`

Specifies the delay in milliseconds between synchronizing successive sets of regions as specified by the value of `iosize`. This can be used to change the impact of synchronization on system performance. The default value of `iodelay` is 0 milliseconds (no delay). Increasing this value slows down synchronization, and reduces the competition for I/O bandwidth with other processes that may be accessing the volume.

Options may be combined as shown in the following examples:

```
# vxsnap -g mydg -o iosize=2m,slow=100 make \
  source=myvol/snapvol=snap2myvol/syncing=on
# vxsnap -g mydg -o iosize=10m,slow=250 syncstart snap2myvol
```

Note These optional parameters only affect the synchronization of full-sized instant snapshots. They are not supported for space-optimized snapshots.

Creating a Volume for Use as a Full-Sized Instant Snapshot

If you want to create a full-sized instant snapshot for an original volume that does not contain any spare plexes, you can use an empty volume with the required degree of redundancy, and with the same size and same region size as the original volume.

To create an empty volume for use by a full-sized instant snapshot:

1. Use the `vxprint` command on the original volume to find the required size for the snapshot volume.

```
# LEN=`vxprint [-g diskgroup] -F%len volume`
```

Note The command shown in this and subsequent steps assumes that you are using a Bourne-type shell such as `sh`, `ksh` or `bash`. You may need to modify the command for other shells such as `csh` or `tcsh`.

2. Use the `vxprint` command on the original volume to discover the name of its DCO:

```
# DCONAME=`vxprint [-g diskgroup] -F%dco_name volume`
```

3. Use the `vxprint` command on the DCO to discover its region size (in blocks):

```
# RSZ=`vxprint [-g diskgroup] -F%regionsz $DCONAME`
```



4. Use the `vxassist` command to create a volume, *snapvol*, of the required size and redundancy, together with a version 20 DCO volume with the correct region size:

```
# vxassist [-g diskgroup] make snapvol $LEN \
  [layout=mirror nmirror=number] logtype=dco dr1=off \
  dcoverison=20 [ndcomirror=number] regionsz=$RSZ init=active \
  [storage_attributes]
```

Specify the same number of DCO mirrors (`ndcomirror`) as the number of mirrors in the volume (`nmirror`). The `init=active` attribute is used to make the volume available immediately. You can use storage attributes to specify which disks should be used for the volume.

As an alternative to creating the snapshot volume and its DCO volume in a single step, you can first create the volume, and then prepare it for instant snapshot operations as shown here:

```
# vxassist [-g diskgroup] make snapvol $LEN \
  [layout=mirror nmirror=number] init=active [storage_attributes]
# vxsnap [-g diskgroup] prepare snapvol [ndcomirs=number] \
  regionsize=$RSZ [storage_attributes]
```

Creating a Shared Cache Object

If you need to create several space-optimized instant snapshots for the volumes in a disk group, you may find it more convenient to create a single shared cache object in the disk group rather than a separate cache object for each snapshot.

To create a shared cache object:

1. Decide on the following characteristics that you want to allocate to the cache volume that underlies the cache object:
 - ◆ The size of the cache volume should be sufficient to record changes to the parent volumes during the interval between snapshot refreshes. A suggested value is 10% of the total size of the parent volumes for a refresh interval of 24 hours.
 - ◆ If redundancy is a desired characteristic of the cache volume, it should be mirrored. This increases the space that is required for the cache volume in proportion to the number of mirrors that it has.
 - ◆ If the cache volume is mirrored, space is required on at least as many disks as it has mirrors. These disks should not be shared with the disks used for the parent volumes. The disks should also be chosen to avoid impacting I/O performance for critical volumes, or hindering disk group split and join operations.

- Having decided on its characteristics, use the `vxassist` command to create the volume that is to be used for the cache volume. The following example creates a mirrored cache volume, `cachevol`, with size 1GB in the disk group, `mydg`, on the disks `mydg16` and `mydg17`:

```
# vxassist -g mydg make cachevol 1g layout=mirror init=active \
  mydg16 mydg17
```

The attribute `init=active` is specified to make the cache volume immediately available for use.

- Use the `vxmake` `cache` command to create a cache object on top of the cache volume that you created in the previous step:

```
# vxmake [-g diskgroup] cache cache_object cachevolname=volume \
  [regionsize=size] [autogrow=on] [highwatermark=hwmk] \
  [autogrowby=agbvalue] [maxautogrow=maxagbvalue]
```

If the region size, `regionsize`, is specified, it must be a power of 2, and be greater than or equal to 16KB (16k). If not specified, the region size of the cache is set to 64KB.

Note All space-optimized snapshots that share the cache must have a region size that is equal to or an integer multiple of the region size set on the cache. Snapshot creation also fails if the original volume's region size is smaller than the cache's region size.

If the region size of a space-optimized snapshot differs from the region size of the cache, this can degrade the system's performance compared to the case where the region sizes are the same.

If the cache is to be allowed to grow in size as required, specify `autogrow=on`. By default, the ability to automatically grow the cache is turned off.

In the following example, the cache object, `cobjmydg`, is created over the cache volume, `cachevol`, the region size of the cache is set to 32KB, and the `autogrow` feature is enabled:

```
# vxmake -g mydg cache cobjmydg cachevolname=cachevol \
  regionsize=32k autogrow=on
```

- Having created the cache object, use the following command to enable it:

```
# vxcache [-g diskgroup] start cache_object
```

For example to start the cache object, `cobjmydg`:

```
# vxcache -g mydg start cobjmydg
```

For details of how to remove a cache, see [“Removing a Cache”](#) on page 298.



Listing the Snapshots Created on a Cache

To list the space-optimized instant snapshots that have been created on a cache object, use the following command:

```
# vxcache [-g diskgroup] listvol cache_object
```

The snapshot names are printed as a space-separated list ordered by timestamp. If two or more snapshots have the same timestamp, these snapshots are sorted in order of decreasing size.

Tuning the Autogrow Attributes

The `highwatermark`, `autogrowby` and `maxautogrow` attributes determine how the VxVM cache daemon (`vxcached`) maintains the cache if the `autogrow` feature has been enabled and `vxcached` is running:

- ◆ When cache usage reaches the high watermark value, `highwatermark` (default value is 90 percent), `vxcached` grows the size of the cache volume by the value of `autogrowby` (default value is 20% of the size of the cache volume in blocks). The new required cache size cannot exceed the value of `maxautogrow` (default value is twice the size of the cache volume in blocks).
- ◆ When cache usage reaches the high watermark value, and the new required cache size would exceed the value of `maxautogrow`, `vxcached` deletes the oldest snapshot in the cache. If there are several snapshots with the same age, the largest of these is deleted.

If the `autogrow` feature has been disabled:

- ◆ When cache usage reaches the high watermark value, `vxcached` deletes the oldest snapshot in the cache. If there are several snapshots with the same age, the largest of these is deleted. If there is only a single snapshot, this snapshot is detached and marked as invalid.

Note The `vxcached` daemon does not remove snapshots that are currently open, and it does not remove the last or only snapshot in the cache.

If the cache space becomes exhausted, the snapshot is detached and marked as invalid. If this happens, the snapshot is unrecoverable and must be removed. Enabling the `autogrow` feature on the cache helps to avoid this situation occurring. However, for very small caches (of the order of a few megabytes), it is possible for the cache to become exhausted before the system has time to respond and grow the cache. In such cases, either

increase the size of the cache manually as described in “[Growing and Shrinking a Cache](#)” on page 297, or use the `vxcache set` command to reduce the value of `highwatermark` as shown in this example:

```
# vxcache -g mydg set highwatermark=60 cobjmydg
```

You can use the `maxautogrow` attribute to limit the maximum size to which a cache can grow. To estimate this size, consider how much the contents of each source volume are likely to change between snapshot refreshes, and allow some additional space for contingency.

If necessary, you can use the `vxcache set` command to change other `autogrow` attribute values for a cache. See the `vxcache(1M)` manual page for details.

Caution Ensure that the cache is sufficiently large, and that the `autogrow` attributes are configured correctly for your needs.

Growing and Shrinking a Cache

You can use the `vxcache` command to increase the size of the cache volume that is associated with a cache object:

```
# vxcache [-g diskgroup] growcacheto cache_object size
```

For example, to increase the size of the cache volume associated with the cache object, `mycache`, to 2GB, you would use the following command:

```
# vxcache -g mydg growcacheto mycache 2g
```

To grow a cache by a specified amount, use the following form of the command shown here:

```
# vxcache [-g diskgroup] growcacheby cache_object size
```

For example, the following command increases the size of `mycache` by 1GB:

```
# vxcache -g mydg growcacheby mycache 1g
```

You can similarly use the `shrinkcacheby` and `shrinkcacheto` operations to reduce the size of a cache. See the `vxcache(1M)` manual page for more information.



Removing a Cache

To remove a cache completely, including the cache object, its cache volume and all space-optimized snapshots that use the cache:

1. Run the following command to find out the names of the top-level snapshot volumes that are configured on the cache object:

```
# vxprint -g diskgroup -vne \  
"v_plex.pl_subdisk.sd_dm_name ~ /cache_object/"
```

where *cache_object* is the name of the cache object.

2. Remove all the top-level snapshots and their dependent snapshots (this can be done with a single command):

```
# vxedit -g diskgroup -r rm snapvol ...
```

where *snapvol* is the name of a top-level snapshot volume.

3. Stop the cache object:

```
# vxcache -g diskgroup stop cache_object
```

4. Finally, remove the cache object and its cache volume:

```
# vxedit -g diskgroup -r rm cache_object
```

Creating Traditional Third-Mirror Break-Off Snapshots

VxVM provides third-mirror break-off snapshot images of volume devices using `vxassist` and other commands.

Note It is recommended that you use the instant snapshot mechanism for backup. Support for traditional third-mirror break-off snapshots created using the `vxassist` command may be removed in a future release. If you are currently using such snapshots, you should consider migrating your backup strategy to use snapshots that have been created using the `vxsnap` command.

To enhance the efficiency and usability of volume snapshots, turn on `FastResync` as described in [“Enabling FastResync on a Volume”](#) on page 252. If Persistent `FastResync` is required, you must associate a version 0 DCO with the volume as described in [“Adding a Version 0 DCO and DCO Volume”](#) on page 307.

You need a full license and a VERITAS FlashSnap™ license to use this feature.

The procedure described in this section requires a plex that is large enough to store the complete contents of the volume. For details of a method that uses space-optimized snapshots, see [“Creating Instant Snapshots”](#) on page 275.

The recommended approach to performing volume backup from the command line, or from a script, is to use the `vxassist` command. The `vxassist snapstart`, `vxassist snapwait`, and `vxassist snapshot` tasks allow you to back up volumes online with minimal disruption to users.

The `vxassist snapshot` procedure consists of two steps:

1. Run `vxassist snapstart` to create a snapshot mirror.
2. Run `vxassist snapshot` to create a snapshot volume.

The `vxassist snapstart` step creates a write-only backup plex which gets attached to and synchronized with the volume. When synchronized with the volume, the backup plex is ready to be used as a snapshot mirror. The end of the update procedure is indicated by the new snapshot mirror changing its state to `SNAPDONE`. This change can be tracked by the `vxassist snapwait` task, which waits until at least one of the mirrors changes its state to `SNAPDONE`. If the attach process fails, the snapshot mirror is removed and its space is released.

Note If the `snapstart` procedure is interrupted, the snapshot mirror is automatically removed when the volume is started.



Once the snapshot mirror is synchronized, it continues being updated until it is detached. You can then select a convenient time at which to create a snapshot volume as an image of the existing volume. You can also ask users to refrain from using the system during the brief time required to perform the snapshot (typically less than a minute). The amount of time involved in creating the snapshot mirror is long in contrast to the brief amount of time that it takes to create the snapshot volume.

The online backup procedure is completed by running the `vxassist snapshot` command on a volume with a SNAPDONE mirror. This task detaches the finished snapshot (which becomes a normal mirror), creates a new normal volume and attaches the snapshot mirror to the snapshot volume. The snapshot then becomes a normal, functioning volume and the state of the snapshot is set to ACTIVE.

To back up a volume with the `vxassist` command, use the following procedure:

1. Create a snapshot mirror for a volume using the following command:

```
# vxassist [-b] [-g diskgroup] snapstart [nmirror=N] volume
```

For example, to create a snapshot mirror of a volume called `voldef`, use the following command:

```
# vxassist [-g diskgroup] snapstart voldef
```

The `vxassist snapstart` task creates a write-only mirror, which is attached to and synchronized from the volume to be backed up.

Note By default, VxVM attempts to avoid placing snapshot mirrors on a disk that already holds any plexes of a data volume. However, this may be impossible if insufficient space is available in the disk group. In this case, VxVM uses any available space on other disks in the disk group. If the snapshot plexes are placed on disks which are used to hold the plexes of other volumes, this may cause problems when you subsequently attempt to move a snapshot volume into another disk group as described in [“Moving DCO Volumes Between Disk Groups”](#) on page 161. To override the default storage allocation policy, you can use storage attributes to specify explicitly which disks to use for the snapshot plexes. See [“Creating a Volume on Specific Disks”](#) on page 203 for more information.

If you start `vxassist snapstart` in the background using the `-b` option, you can use the `vxassist snapwait` command to wait for the creation of the mirror to complete as shown here:

```
# vxassist [-g diskgroup] snapwait volume
```

If `vxassist snapstart` is not run in the background, it does not exit until the mirror has been synchronized with the volume. The mirror is then ready to be used as a plex of a snapshot volume. While attached to the original volume, its contents continue to be updated until you take the snapshot.

Use the `nmirror` attribute to create as many snapshot mirrors as you need for the snapshot volume. For a backup, you should usually only require the default of one.

It is also possible to make a snapshot plex from an existing plex in a volume. See [“Converting a Plex into a Snapshot Plex”](#) on page 302 for details.

2. Choose a suitable time to create a snapshot. If possible, plan to take the snapshot at a time when users are accessing the volume as little as possible.
3. Create a snapshot volume using the following command:

```
# vxassist [-g diskgroup] snapshot [nmirror=N] volume snapshot
```

If required, use the `nmirror` attribute to specify the number of mirrors in the snapshot volume.

For example, to create a snapshot of `voldef`, use the following command:

```
# vxassist [-g diskgroup] snapshot voldef snapvol
```

The `vxassist snapshot` task detaches the finished snapshot mirror, creates a new volume, and attaches the snapshot mirror to it. This step should only take a few minutes. The snapshot volume, which reflects the original volume at the time of the snapshot, is now available for backing up, while the original volume continues to be available for applications and users.

If required, you can make snapshot volumes for several volumes in a disk group at the same time. See [“Creating Multiple Snapshots”](#) on page 303 for more information.

4. Use `fsck` (or some utility appropriate for the application running on the volume) to clean the temporary volume’s contents. For example, you can use this command with a VxFS file system:

```
# fsck -F vxfs /dev/vx/rdisk/diskgroup/snapshot
```
5. If you require a backup of the data in the snapshot, use an appropriate utility or operating system command to copy the contents of the snapshot to tape, or to some other backup medium.

When the backup is complete, you have the following choices for what to do with the snapshot volume:

- ◆ Reattach some or all of the plexes of the snapshot volume with the original volume as described in [“Reattaching a Snapshot Volume \(`vxassist snapback`\)”](#) on page 304. If `FastResync` was enabled on the volume before the snapshot was taken, this speeds resynchronization of the snapshot plexes before the backup cycle starts again at [step 3](#).



- ◆ Dissociate the snapshot volume entirely from the original volume as described in “[Dissociating a Snapshot Volume \(vxassist snapclear\)](#)” on page 305. This may be useful if you want to use the copy for other purposes such as testing or report generation.
- ◆ Remove the snapshot volume to save space with this command:

```
# vxedit [-g diskgroup] -rf rm snapshot
```

Note Dissociating or removing the snapshot volume loses the advantage of fast resynchronization if FastResync was enabled. If there are no further snapshot plexes available, any subsequent snapshots that you take require another complete copy of the original volume to be made.

Converting a Plex into a Snapshot Plex

Note The procedure described in this section cannot be used with layered volumes or any volume that has an associated version 20 DCO volume.

It is recommended that the instant snapshot feature is used in preference to the procedure described in this section.

In some circumstances, you may find it more convenient to convert an existing plex in a volume into a snapshot plex rather than running `vxassist snapstart`. For example, you may want to do this if you are short of disk space for creating the snapshot plex and the volume that you want to snapshot contains more than two plexes.

The procedure can also be used to speed up the creation of a snapshot volume when a mirrored volume is created with more than two plexes and `init=active` is specified.

Note It is advisable to retain at least two plexes in a volume to maintain data redundancy.

To convert an existing plex into a snapshot plex for a volume on which Persistent FastResync is enabled, use the following command:

```
# vxplex [-g diskgroup] -o dcoplex=dcologplex convert \
state=SNAPDONE plex
```

`dcologplex` is the name of an existing DCO plex that is to be associated with the new snapshot plex. You can use the `vxprint` command to find out the name of the DCO volume as described in “[Adding a Version 0 DCO and DCO Volume](#)” on page 307.

For example, to make a snapshot plex from the plex `trivol-03` in the 3-plex volume `trivol`, you would use the following command:

```
# vxplex -o dcoplex=trivol_dcl-03 convert state=SNAPDONE trivial-03
```

Here the DCO plex `trivol_dco_03` is specified as the DCO plex for the new snapshot plex.

To convert an existing plex into a snapshot plex in the `SNAPDONE` state for a volume on which Non-Persistent FastResync is enabled, use the following command:

```
# vxplex [-g diskgroup] convert state=SNAPDONE plex
```

A converted plex is in the `SNAPDONE` state, and can be used immediately to create a snapshot volume.

Note The last complete regular plex in a volume, an incomplete regular plex, or a dirty region logging (DRL) log plex cannot be converted into a snapshot plex.

Creating Multiple Snapshots

To make it easier to create snapshots of several volumes at the same time, the snapshot option accepts more than one volume name as its argument, for example:

```
# vxassist [-g diskgroup] snapshot volume1 volume2 ...
```

By default, the first snapshot volume is named `SNAP-volume`, and each subsequent snapshot is named `SNAPnumber-volume`, where *number* is a unique serial number, and *volume* is the name of the volume for which the snapshot is being taken. This default pattern can be overridden by using the option `-o name=pattern`, as described on the `vxassist(1M)` manual page. For example, the pattern `SNAP%v-%d` reverses the order of the *number* and *volume* components in the name.

To snapshot all the volumes in a single disk group, specify the option `-o allvols` to `vxassist`:

```
# vxassist -g diskgroup -o allvols snapshot
```

This operation requires that all `snapstart` operations are complete on the volumes. It fails if any of the volumes in the disk group do not have a complete snapshot plex in the `SNAPDONE` state.



Reattaching a Snapshot Volume (vxassist snapback)

Note The information in this section does not apply to RAID-5 volumes unless they have been converted to a special layered volume layout by the addition of a DCO and DCO volume. See “[Adding a Version 0 DCO and DCO Volume](#)” on page 307 for details.

Snapback merges a snapshot copy of a volume with the original volume. One or more snapshot plexes are detached from the snapshot volume and re-attached to the original volume. The snapshot volume is removed if all its snapshot plexes are snapped back. This task resynchronizes the data in the volume so that the plexes are consistent.

Note To enhance the efficiency of the snapback operation, enable FastResync on the volume before taking the snapshot, as described in “[Enabling FastResync on a Volume](#)” on page 252.

To merge one snapshot plex with the original volume, use the following command:

```
# vxassist [-g diskgroup] snapback snapshot
```

where *snapshot* is the snapshot copy of the volume.

To merge all snapshot plexes in the snapshot volume with the original volume, use the following command:

```
# vxassist [-g diskgroup] -o allplexes snapback snapshot
```

To merge a specified number of plexes from the snapshot volume with the original volume, use the following command:

```
# vxassist [-g diskgroup] snapback nmirror=number snapshot
```

Here the *nmirror* attribute specifies the number of mirrors in the snapshot volume that are to be re-attached.

Once the snapshot plexes have been reattached and their data resynchronized, they are ready to be used in another *snapshot* operation.

By default, the data in the original volume is used to update the snapshot plexes that have been re-attached. To copy the data from the replica volume instead, use the following command:

```
# vxassist [-g diskgroup] -o resyncfromreplica snapback snapshot
```

Caution Always unmount the snapshot volume (if mounted) before performing a snapback. In addition, you must unmount the file system corresponding to the primary volume before using the *resyncfromreplica* option.

Adding Plexes to a Snapshot Volume

If you want to retain the existing plexes in a snapshot volume after a snapback operation, create additional snapshot plexes that are to be used for the snapback:

1. Use the following `vxprint` commands to discover the names of the snapshot volume's data change object (DCO) and DCO volume:

```
# DCONAME=`vxprint [-g diskgroup] -F%dco_name snapshot`
# DCOVOL=`vxprint [-g diskgroup] -F%log_vol $DCONAME`
```

2. Use the `vxassist mirror` command to create mirrors of the existing snapshot volume and its DCO volume:

```
# vxassist -g diskgroup mirror snapshot
# vxassist -g diskgroup mirror $DCOVOL
```

Note The new plex in the DCO volume is required for use with the new data plex in the snapshot.

3. Use the `vxprint` command to find out the name of the additional snapshot plex:

```
# vxprint -g diskgroup snapshot
```

4. Use the `vxprint` command to find out the record ID of the additional DCO plex:

```
# vxprint -g diskgroup -F%rid $DCOVOL
```

5. Use the `vxedit` command to set the `dco_plex_riid` field of the new data plex to the name of the new DCO plex:

```
# vxedit -g diskgroup set dco_plex_riid=dco_plex_riid new_plex
```

The new data plex is now ready to be used to perform a snapback operation.

Dissociating a Snapshot Volume (`vxassist snapclear`)

The link between a snapshot and its original volume can be permanently broken so that the snapshot volume becomes an independent volume. Use the following command to dissociate the snapshot volume, *snapshot*:

```
# vxassist snapclear snapshot
```



Displaying Snapshot Information (vxassist snapprint)

The `vxassist snapprint` command displays the associations between the original volumes and their respective replicas (snapshot copies):

```
# vxassist snapprint [volume]
```

Output from this command is shown in the following examples:

```
# vxassist -g mydg snapprint v1
V NAME          USETYPE      LENGTH
SS SNAPOBJ      NAME          LENGTH        %DIRTY
DP NAME          VOLUME        LENGTH        %DIRTY

v v1             fsgen         20480
ss SNAP-v1_snp  SNAP-v1       20480         4
dp v1-01         v1            20480         0
dp v1-02         v1            20480         0

v SNAP-v1        fsgen         20480
ss v1_snp        v1            20480         0
# vxassist -g mydg snapprint v2
V NAME          USETYPE      LENGTH
SS SNAPOBJ      NAME          LENGTH        %DIRTY
DP NAME          VOLUME        LENGTH        %DIRTY

v v2             fsgen         20480
ss --            SNAP-v2       20480         0
dp v2-01         v2            20480         0

v SNAP-v2        fsgen         20480
ss --            v2            20480         0
```

In this example, Persistent FastResync is enabled on volume `v1`, and Non-Persistent FastResync on volume `v2`. Lines beginning with `v`, `dp` and `ss` indicate a volume, detached plex and snapshot plex respectively. The `%DIRTY` field indicates the percentage of a snapshot plex or detached plex that is dirty with respect to the original volume. Notice that no snap objects are associated with volume `v2` or with its snapshot volume `SNAP-v2`. See [“How Persistent FastResync Works with Snapshots”](#) on page 53 for more information about snap objects.

If a volume is specified, the `snapprint` command displays an error message if no FastResync maps are enabled for that volume.



Adding a Version 0 DCO and DCO Volume

Note The procedure described in this section adds a DCO log volume that has a version 0 layout as introduced in VxVM 3.2. The version 0 layout supports traditional (third-mirror break-off) snapshots, but not full-sized or space-optimized instant snapshots. See [“Version 0 DCO Volume Layout”](#) on page 51 and [“Version 20 DCO Volume Layout”](#) on page 51 for a description of the differences between the old and new DCO volume layouts.

See [“Determining the DCO Version Number”](#) on page 238 for details of how to determine the version number of a volume’s DCO.

To put Persistent FastResync into effect for a volume, a Data Change Object (DCO) and DCO volume must first be associated with that volume. When you have added a DCO object and DCO volume to a volume, you can then enable Persistent FastResync on the volume as described in [“Enabling FastResync on a Volume”](#) on page 252.

Note You need a VERITAS FlashSnap™ or FastResync license to use the FastResync feature. Even if you do not have a license, you can configure a DCO object and DCO volume so that snap objects are associated with the original and snapshot volumes. For more information about snap objects, see [“How Persistent FastResync Works with Snapshots”](#) on page 53.

To add a DCO object and DCO volume to an existing volume (which may already have dirty region logging (DRL) enabled), use the following procedure:

1. Ensure that the disk group containing the existing volume has been upgraded to at least version 90. Use the following command to check the version of a disk group:

```
# vx dg list diskgroup
```

To upgrade a disk group to the latest version, use the following command:

```
# vx dg upgrade diskgroup
```

For more information, see [“Upgrading a Disk Group”](#) on page 169.

2. Use the following command to turn off Non-Persistent FastResync on the original volume if it is currently enabled:

```
# vxvol [-g diskgroup] set fastresync=off volume
```

If you are uncertain about which volumes have Non-Persistent FastResync enabled, use the following command to obtain a listing of such volumes:

```
# vxprint [-g diskgroup] -F "%name" \
-e "v_fastresync=on && !v_hasdcolog"
```



3. Use the following command to add a DCO and DCO volume to the existing volume:

```
# vxassist [-g diskgroup] addlog volume logtype=dco \  
  [ndcomirror=number] [dcolen=size] [storage_attributes]
```

For non-layered volumes, the default number of plexes in the mirrored DCO volume is equal to the lesser of the number of plexes in the data volume or 2. For layered volumes, the default number of DCO plexes is always 2. If required, use the `ndcomirror` attribute to specify a different *number*. It is recommended that you configure as many DCO plexes as there are existing data and snapshot plexes in the volume. For example, specify `ndcomirror=3` when adding a DCO to a 3-way mirrored volume.

The default size of each plex is 132 blocks. You can use the `dcolen` attribute to specify a different *size*. If specified, the size of the plex must be a integer multiple of 33 blocks from 33 up to a maximum of 2112 blocks.

You can specify `vxassist`-style storage attributes to define the disks that can and/or cannot be used for the plexes of the DCO volume. See [“Specifying Storage for Version 0 DCO Plexes”](#) on page 308 for details.

Specifying Storage for Version 0 DCO Plexes

Note The operations in this section relate to version 0 DCO volumes. They are not supported for the version 20 DCO volume layout that was introduced in VxVM 4.0.

If the disks that contain volumes and their snapshots are to be moved or split into different disk groups, the disks that contain their respective DCO plexes must be able to accompany them. By default, VxVM attempts to place the DCO plexes on the same disks as the data plexes of the parent volume. However, this may be impossible if there is insufficient space available on those disks. In this case, VxVM uses any available space on other disks in the disk group. If the DCO plexes are placed on disks which are used to hold the plexes of other volumes, this may cause problems when you subsequently attempt to move volumes into other disk groups.

You can use storage attributes to specify explicitly which disks to use for the DCO plexes. If possible, specify the same disks as those on which the volume is configured. For example, to add a DCO object and DCO volume with plexes on `mydg05` and `mydg06`, and a plex size of 264 blocks to the volume, `myvol`, in the disk group, `mydg`, use the following command:

```
# vxassist -g mydg addlog myvol logtype=dco dcolen=264 \  
  mydg05 mydg06
```

To view the details of the DCO object and DCO volume that are associated with a volume, use the `vxprint` command. The following is partial `vxprint` output for the volume named `vol1` (the `TUTIL0` and `PUTIL0` columns are omitted for clarity):

TY	NAME	ASSOC	KSTATE	LENGTH	PLOFFS	STATE	...
v	vol1	fsgen	ENABLED	1024	-	ACTIVE	
pl	vol1-01	vol1	ENABLED	1024	-	ACTIVE	
sd	disk01-01	vol1-01	ENABLED	1024	0	-	
pl	vol1-02	vol1	ENABLED	1024	-	ACTIVE	
sd	disk02-01	vol1-02	ENABLED	1024	0	-	
dc	vol1_dco	vol1	-	-	-	-	
v	vol1_dcl	gen	ENABLED	132	-	ACTIVE	
pl	vol1_dcl-01	vol1_dcl	ENABLED	132	-	ACTIVE	
sd	disk03-01	vol1_dcl-01	ENABLED	132	0	-	
pl	vol1_dcl-02	vol1_dcl	ENABLED	132	-	ACTIVE	
sd	disk04-01	vol1_dcl-02	ENABLED	132	0	-	

In this output, the DCO object is shown as `vol1_dco`, and the DCO volume as `vol1_dcl` with 2 plexes, `vol1_dcl-01` and `vol1_dcl-02`.

If required, you can use the `vxassist move` command to relocate DCO plexes to different disks. For example, the following command moves the plexes of the DCO volume, `vol1_dcl`, for volume `vol1` from `disk03` and `disk04` to `disk07` and `disk08`:

```
# vxassist -g mydg move vol1_dcl !disk03 !disk04 disk07 disk08
```

For more information, see “[Moving DCO Volumes Between Disk Groups](#)” on page 161, and the `vxassist(1M)` manual page.

Removing a Version 0 DCO and DCO Volume

Note The operations in this section relate to version 0 DCO volumes. They are not supported for the version 20 DCO volume layout that was introduced in VxVM 4.0.

To dissociate a DCO object, DCO volume and any snap objects from a volume, use the following command:

```
# vxassist [-g diskgroup] remove log volume logtype=dco
```

This completely removes the DCO object, DCO volume and any snap objects. It also has the effect of disabling `FastResync` for the volume.

Alternatively, you can use the `vxdc` command to the same effect:

```
# vxdc [-g diskgroup] [-o rm] dis dco_obj
```

The default name of the DCO object, `dco_obj`, for a volume is usually formed by appending the string `_dco` to the name of the parent volume. To find out the name of the associated DCO object, use the `vxprint` command on the volume.



To dissociate, but not remove, the DCO object, DCO volume and any snap objects from the volume, `myvol`, in the disk group, `mydg`, use the following command:

```
# vxdc0 -g mydg dis myvol_dco
```

This form of the command dissociates the DCO object from the volume but does not destroy it or the DCO volume. If the `-o rm` option is specified, the DCO object, DCO volume and its plexes, and any snap objects are also removed.

Note Dissociating a DCO and DCO volume disables Persistent FastResync on the volume. A full resynchronization of any remaining snapshots is required when they are snapped back.

For more information, see the `vxassist(1M)` and `vxdc0(1M)` manual pages.

Reattaching a Version 0 DCO and DCO Volume

Note The operations in this section relate to version 0 DCO volumes. They are not supported for version 20 DCO volume layout that was introduced in VxVM 4.0.

If the DCO object and DCO volume are not removed by specifying the `-o rm` option to `vxdc0`, they can be reattached to the parent volume using the following command:

```
# vxdc0 [-g diskgroup] att volume dco_obj
```

For example, to reattach the DCO object, `myvol_dco`, to the volume, `myvol`, use the following command:

```
# vxdc0 -g mydg att myvol myvol_dco
```

For more information, see the `vxdc0(1M)` manual page.

Creating and Administering Volume Sets

10

This chapter describes how to use the `vxvset` command to create and administer volume sets in VERITAS Volume Manager (VxVM). Volume sets enable the use of the Multi-Volume Support feature with VERITAS File System (VxFS). It is also possible to use the VERITAS Enterprise Administrator (VEA) to create and administer volumes sets. For more information, see the VEA online help.

For full details of the usage of the `vxvset` command, see the `vxvset(1M)` manual page.

Note Most VxVM commands require superuser or equivalent privileges.

Please note the following limitation of volume sets:

- ◆ A maximum of 256 volumes may be configured in a volume set.
- ◆ Only VERITAS File System is supported on a volume set.
- ◆ The first volume (index 0) in a volume set must be larger than the sum of the total volume size divided by 4000, the size of the VxFS intent log, and 1MB.
- ◆ Raw I/O from and to a volume set is not supported.
- ◆ Volume sets can be used in place of volumes with the following `vxsnap` operations on instant snapshots: `addmir`, `dis`, `make`, `prepare`, `reattach`, `refresh`, `restore`, `rmmir`, `split`, `syncpause`, `syncresume`, `syncstart`, `syncstop`, `syncwait`, and `unprepare`. The third-mirror break-off usage model for full-sized instant snapshots is supported for volume sets provided that sufficient plexes exist for each volume in the volume set. See “[Administering Volume Snapshots](#)” on page 261 and “[Creating Instant Snapshots of Volume Sets](#)” on page 284 for more information.
- ◆ A full-sized snapshot of a volume set must itself be a volume set with the same number of volumes and the same volume index numbers as the parent. The corresponding volumes in the parent and snapshot volume sets are also subject to the same restrictions as apply between standalone volumes and their snapshots.



Creating a Volume Set

To create a volume set for use by VERITAS File System (VxFS), use the following command:

```
# vxvset [-g diskgroup] -t vxfs make volset volume
```

Here *volset* is the name of the volume set, and *volume* is the name of the first volume in the volume set. The `-t` option defines the content handler subdirectory for the application that is to be used with the volume. This subdirectory contains utilities that an application uses to operate on the volume set. As the operation of these utilities is determined by the requirements of the application and not by VxVM, it is not discussed further here.

For example, to create a volume set named `myvset` that contains the volume `vol1`, in the disk group `mydg`, you would use the following command:

```
# vxvset -g mydg -t vxfs make myvset vol1
```

Adding a Volume to a Volume Set

Having created a volume set containing a single volume, you can use the following command to add further volumes to the volume set:

```
# vxvset [-g diskgroup] [-f] addvol volset volume
```

For example, to add the volume `vol2`, to the volume set `myvset`, use the following command:

```
# vxvset -g mydg addvol myvset vol2
```

Caution The `-f` (force) option must be specified if the volume being added, or any volume in the volume set, is either a snapshot or the parent of a snapshot. Using this option can potentially cause inconsistencies in a snapshot hierarchy if any of the volumes involved in the operation is already in a snapshot chain.

Listing Details of Volume Sets

To list the details of the component volumes of a volume set, use the following command:

```
# vxvset [-g diskgroup] list [volset]
```

If the name of a volume set is not specified, the command lists the details of all volume sets in a disk group, as shown in the following example:

```
# vxvset -g mydg list
NAME          GROUP      NVOLS      CONTEXT
set1          mydg       3          -
set2          mydg       2          -
```

To list the details of each volume in a volume set, specify the name of the volume set as an argument to the command:

```
# vxvset -g mydg list set1
VOLUME        INDEX      LENGTH      KSTATE      CONTEXT
vol1          0          12582912    ENABLED     -
vol2          1          12582912    ENABLED     -
vol3          2          12582912    ENABLED     -
```

The context field contains details of any string that the application has set up for the volume or volume set to tag its purpose.

Stopping and Starting Volume Sets

Under some circumstances, you may need to stop and restart a volume set. For example, a volume within the set may have become detached, as shown here:

```
# vxvset -g mydg list set1
VOLUME        INDEX      LENGTH      KSTATE      CONTEXT
vol1          0          12582912    DETACHED    -
vol2          1          12582912    ENABLED     -
vol3          2          12582912    ENABLED     -
```

To stop and restart one or more volume sets, use the following commands:

```
# vxvset [-g diskgroup] stop volset ...
# vxvset [-g diskgroup] start volset ...
```



For the example given previously, the effect of running these commands on the component volumes is shown below:

```
# vxvset -g mydg stop set1

# vxvset -g mydg list set1
VOLUME          INDEX          LENGTH          KSTATE  CONTEXT
vol1             0             12582912       DISABLED -
vol2             1             12582912       DISABLED -
vol3             2             12582912       DISABLED -

# vxvset -g mydg start set1

# vxvset -g mydg list set1
VOLUME          INDEX          LENGTH          KSTATE  CONTEXT
vol1             0             12582912       ENABLED  -
vol2             1             12582912       ENABLED  -
vol3             2             12582912       ENABLED  -
```

Removing a Volume from a Volume Set

To remove a component volume from a volume set, use the following command:

```
# vxvset [-g diskgroup] [-f] rmvol volset volume
```

For example, the following commands remove the volumes, `vol1` and `vol2`, from the volume set `myvset`:

```
# vxvset -g mydg rmvol myvset vol1
# vxvset -g mydg rmvol myvset vol2
```

Note When the final volume is removed, this deletes the volume set.

Caution The `-f` (force) option must be specified if the volume being removed, or any volume in the volume set, is either a snapshot or the parent of a snapshot. Using this option can potentially cause inconsistencies in a snapshot hierarchy if any of the volumes involved in the operation is already in a snapshot chain.

Off-host processing allows you to implement the following activities:

- ◆ *Data Backup*—As the requirement for 24 x 7 availability becomes essential for many businesses, organizations cannot afford the downtime involved in backing up critical data offline. By taking a snapshot of the data, and backing up from this snapshot, business-critical applications can continue to run without extended down time or impacted performance.
- ◆ *Decision Support Analysis and Reporting*—Because snapshots hold a point-in-time copy of a production database, a replica of the database can be set up using the snapshots. Operations such as decision support analysis and business reporting do not require access to up-to-the-minute information. This means that they can use a database copy that is running on a host other than the primary. When required, the database copy can quickly be synchronized with the data in the primary database.
- ◆ *Testing and Training*—Development or service groups can use snapshots as test data for new applications. Snapshot data provides developers, system testers and QA groups with a realistic basis for testing the robustness, integrity and performance of new applications.
- ◆ *Database Error Recovery*—Logic errors caused by an administrator or an application program can compromise the integrity of a database. By restoring the database table files from a snapshot copy, the database can be recovered more quickly than by full restoration from tape or other backup media.

Off-host processing is made possible by using the FastResync and disk group move, split and join features of VxVM. These features are described in the following sections.

You can also use such solutions in conjunction with the cluster functionality of VxVM. For implementation guidelines, see [“Implementing Off-Host Processing Solutions”](#) on page 317.



FastResync of Volume Snapshots

Note You need a VERITAS FlashSnap™ or FastResync license to use this feature.

VxVM allows you to take multiple snapshots of your data at the level of a volume. A snapshot volume contains a stable copy of a volume's data at a given moment in time that you can use for online backup or decision support. If FastResync is enabled on a volume, VxVM uses a *FastResync map* to keep track of which blocks are updated in the volume and in the snapshot. If the data in one mirror is not updated for some reason, it becomes out-of-date, or *stale*, with respect to the other mirrors in the volume. The presence of the FastResync map means that only those updates that the mirror has missed need be reapplied to resynchronize it with the volume. A full, and therefore much slower, resynchronization of the mirror from the volume is unnecessary.

The persistent form of FastResync ensures that FastResync maps survive both system crashes and cluster restarts. When snapshot volumes are reattached to their original volumes, FastResync allows the snapshot data to be quickly refreshed and re-used. If Persistent FastResync is enabled on a volume in a private disk group, such incremental resynchronization can happen even if the host is rebooted.

Persistent FastResync can track the association between volumes and their snapshot volumes after they are moved into different disk groups. When the disk groups are rejoined, this allows the snapshot plexes to be quickly resynchronized. Non-Persistent FastResync cannot be used for this purpose.

For more information, see "[Volume Snapshots](#)" on page 45 and "[FastResync](#)" on page 49.

Disk Group Split and Join

Note You need a VERITAS FlashSnap™ license to use this feature.

A volume, such as a snapshot volume, can be split off into a separate disk group and deported. It is then ready for importing on another host that is dedicated to off-host processing. This host need not be a member of a cluster but must have access to the disks. At a later stage, the disk group can be deported, re-imported, and joined with the original disk group or with a different disk group.

For more information, see "[Reorganizing the Contents of Disk Groups](#)" on page 155.

Implementing Off-Host Processing Solutions

As shown in “[Example Implementation of Off-Host Processing](#),” by accessing snapshot volumes from a lightly loaded host (shown here as the *OHP host*), CPU- and I/O-intensive operations for online backup and decision support do not degrade the performance of the primary host that is performing the main production activity (such as running a database). Also, if you place the snapshot volumes on disks that are attached to different host controllers than the disks in the primary volumes, it is possible to avoid contending with the primary host for I/O resources.

Example Implementation of Off-Host Processing

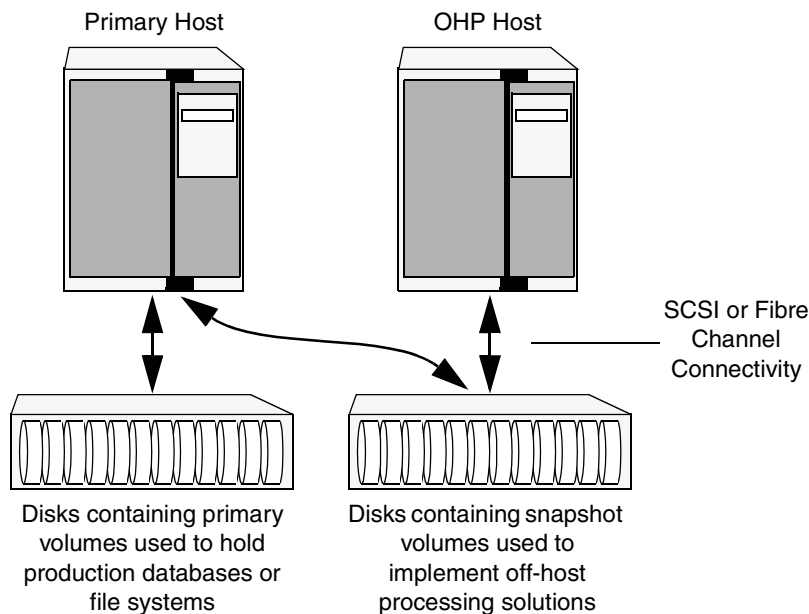

The following sections describe how you can apply off-host processing to implement regular online backup of a volume in a private disk group, and to set up a replica of a production database for decision support. Two applications are outlined in the following sections:

- ◆ [Implementing Online Backup](#)
- ◆ [Implementing Decision Support](#)

These applications use the Persistent FastResync and disk group move, split and join features of VxVM in conjunction with volume snapshots.



Note A volume snapshot represents the data that exists in a volume at a given point in time. As such, VxVM does not have any knowledge of data that is cached by the overlying file system, or by applications such as databases that have files open in the file system. If the `fsngen` volume usage type is set on a volume that contains a VERITAS File System (VxFS), intent logging of the file system metadata ensures the internal consistency of the file system that is backed up. For other file system types, depending on the intent logging capabilities of the file system, there may potentially be inconsistencies between in-memory data and the data in the snapshot image.

For databases, a suitable mechanism must additionally be used to ensure the integrity of tablespace data when the volume snapshot is taken. The facility to temporarily suspend file system I/O is provided by most modern database software. For ordinary files in a file system, which may be open to a wide variety of different applications, there may be no way to ensure the complete integrity of the file data other than by shutting down the applications and temporarily unmounting the file system. In many cases, it may only be important to ensure the integrity of file data that is not in active use at the time that you take the snapshot.

Implementing Online Backup

This section describes a procedure for implementing off-host online backup for a volume in a private disk group. The intention is to present an outline of how to set up a regular backup cycle by combining the Persistent FastResync and disk group split and join features of VxVM. It is beyond the scope of this guide to describe how to configure a database to use this procedure, or how to perform the backup itself.

To back up a volume in a private disk group, use the following procedure.

1. Use the following command on the primary host to see if the volume is associated with a version 20 data change object (DCO) and DCO volume that allow instant snapshots and Persistent FastResync to be used with the volume:

```
# vxprint -g volumedg -F%instant volume
```

This command returns `on` if the volume can be used for instant snapshot operations; otherwise, it returns `off`.

Note If the volume was created under VxVM 4.0 or a later release, and it is not associated with a new-style DCO object and DCO volume, follow the procedure described in [“Preparing a Volume for DRL and Instant Snapshots”](#) on page 235.

If the volume was created before release 4.0 of VxVM, and it has any attached snapshot plexes or it is associated with any snapshot volumes, follow the procedure given in [“Upgrading Existing Volumes to Use Version 20 DCOs”](#) on page 240.

2. Use the following command on the primary host to check whether FastResync is enabled on the volume:

```
# vxprint -g volumedg -F%fastresync volume
```

This command returns on if FastResync is enabled; otherwise, it returns off.

If FastResync is disabled, enable it using the following command on the primary host:

```
# vxvol -g volumedg set fastresync=on volume
```

3. Add one or more snapshot plexes to the volume using this command:

```
# vxsnap -g volumedg addmir volume [nmirror=N]
```

By default, one snapshot plex is added unless you specify a number using the `nmirror` attribute. For a backup, you should usually only require one plex.

Alternatively, create a new volume for use as the snapshot volume as described in [“Creating a Volume for Use as a Full-Sized Instant Snapshot”](#) on page 293.

4. If you added one or more snapshot plexes to the volume in [step 3](#), create a full-sized instant snapshot volume, *snapvol*, by running the following command on the primary host:

```
# vxsnap -g volumedg make source=volume/newvol=snapvol/nmirror=N
```

This version of the `vxsnap make` command uses the `nmirror` attribute to specify how many snapshot plexes of the original volume are to be broken off to form the snapshot volume.

If you created a new volume, *snapvol*, for use as the snapshot volume in [step 3](#), use the following version of the `vxsnap` command to create the snapshot on this volume:

```
# vxsnap -g volumedg make source=volume/snapvol=snapvol
```

Note By default, VxVM attempts to avoid placing snapshot mirrors on a disk that already holds any plexes of a data volume. However, this may be impossible if insufficient space is available in the disk group. In this case, VxVM uses any available space on other disks in the disk group. If the snapshot plexes are



placed on disks which are used to hold the plexes of other volumes, this may cause problems when you subsequently attempt to move a snapshot volume into another disk group as described in “[Moving DCO Volumes Between Disk Groups](#)” on page 161. To override the default storage allocation policy, you can use storage attributes to specify explicitly which disks to use for the snapshot plexes. See “[Creating a Volume on Specific Disks](#)” on page 203 for more information.

If a database spans more than one volume, you can specify all the volumes and their snapshot volumes using one command, as shown in this example:

```
# vxsnap -g dbasedg make source=vol1/newvol=snapvol1/nmirror=1 \  
source=vol2/newvol=snapvol2/nmirror=1 \  
source=vol3/newvol=snapvol3/nmirror=1
```

Note This step sets up the snapshot volumes ready for the backup cycle, and starts tracking changes to the original volumes. When you are ready to make a backup, proceed to [step 5](#).

5. On the primary host, suspend updates to the volume that contains the database tables. The database may have a hot backup mode that allows you to do this by temporarily suspending writes to its tables.
6. On the primary host, refresh the plexes of the snapshot volume using the following command:

```
# vxsnap [-g diskgroup] refresh snapvol source=volume syncing=yes
```

For a database, multiple snapshots can be refreshed in parallel, as shown in this example:

```
# vxsnap -g dbasedg refresh snapvol1 source=vol1 snapvol2 \  
source=vol2 snapvol3 source=vol3 syncing=yes
```

7. On the primary host, if you temporarily suspended updates to the volume by a database in [step 5](#), release all the tables from hot backup mode.
8. The snapshot volume must be completely synchronized before you can move it into another disk group. You can use the `vxsnap syncwait` command to wait for the synchronization to complete as shown here:

```
# vxsnap -g volumedg syncwait snapvol
```

The `vxsnap syncwait` command exits with an exit code of zero when the snapshot volume has been synchronized with the parent volume.

If required, you can use the following command to verify whether the `V_PFLAG_INCOMPLETE` flag is set on a volume:

```
# vxprint [-g diskgroup] -F%incomplete snapvol
```

This command returns the value `off` if synchronization of the volume, *snapvol*, is complete; otherwise, it returns the value `on`.

You can also use the `vxsnap print` command to check on the progress of synchronization as described in “[Displaying Instant Snapshot Information \(vxsnap print\)](#)” on page 291.

9. On the primary host, use the following command to split the snapshot volume into a separate disk group, *snapvoldg*, from the original disk group, *volumedg*:

```
# vxdg split volumedg snapvoldg snapvol
```

10. On the primary host, deport the snapshot volume’s disk group using the following command:

```
# vxdg deport snapvoldg
```

11. On the OHP host where the backup is to be performed, use the following command to import the snapshot volume’s disk group:

```
# vxdg import snapvoldg
```

12. The snapshot volume is initially disabled following the split. Use the following commands on the OHP host to recover and restart the snapshot volume:

```
# vxrecover -g snapvoldg -m snapvol
# vxvol -g snapvoldg start snapvol
```

13. On the OHP host, back up the snapshot volume. If you need to remount the file system in the volume to back it up, first run `fsck` on the volume. The following are sample commands for checking and mounting a file system:

```
# fsck -F vxfs /dev/vx/rdisk/snapvoldg/snapvol
# mount -F vxfs /dev/vx/dsk/snapvoldg/snapvol mount_point
```

Back up the file system at this point, and then use the following command to unmount it.

```
# umount mount_point
```

14. On the OHP host, use the following command to deport the snapshot volume’s disk group:

```
# vxdg deport snapvoldg
```



15. On the primary host, re-import the snapshot volume's disk group using the following command:

```
# vxdg import snapvoldg
```

16. On the primary host, use the following command to rejoin the snapshot volume's disk group with the original volume's disk group:

```
# vxdg join snapvoldg volumedg
```

17. The snapshot volume is initially disabled following the join. Use the following commands on the primary host to recover and restart the snapshot volume:

```
# vxrecover -g volumedg -m snapvol  
# vxvol -g volumedg start snapvol
```

The contents of the snapshot volume are now ready to be refreshed.

Repeat steps 5 through 17 each time that you need to back up the volume.

Implementing Decision Support

This section describes a procedure for implementing off-host decision support for a volume in a private disk group. The intention is to present an outline of how to set up a replica database by combining the Persistent FastResync and disk group split and join features of VxVM. It is beyond the scope of this guide to describe how to configure a database to use this procedure.

To set up a replica database using the table files that are configured within a volume in a private disk group, use the following procedure.

1. Use the following command on the primary host to see if the volume is associated with a version 20 data change object (DCO) and DCO volume that allow instant snapshots and Persistent FastResync to be used with the volume:

```
# vxprint -g volumedg -Finstant volume
```

This command returns `on` if the volume can be used for instant snapshot operations; otherwise, it returns `off`.

Note If the volume was created under VxVM 4.0 or a later release, and it is not associated with a new-style DCO object and DCO volume, follow the procedure described in [“Preparing a Volume for DRL and Instant Snapshots”](#) on page 235.

If the volume was created before release 4.0 of VxVM, and has any attached snapshot plexes, or is associated with any snapshot volumes, follow the procedure given in [“Upgrading Existing Volumes to Use Version 20 DCOs”](#) on page 240.

2. Use the following command on the primary host to check whether FastResync is enabled on a volume:

```
# vxprint -g volumedg -F%fastresync volume
```

This command returns on if FastResync is enabled; otherwise, it returns off.

If FastResync is disabled, enable it using the following command on the primary host:

```
# vxvol -g volumedg set fastresync=on volume
```

3. Prepare the OHP host to receive the snapshot volume that contains the copy of the database tables. This may involve setting up private volumes to contain any redo logs, and configuring any files that are used to initialize the database.
4. Add one or more snapshot plexes to the volume using this command:

```
# vxsnap -g volumedg addmir volume [nmirror=N]
```

By default, one snapshot plex is added unless you specify a number using the `nmirror` attribute. For applications where data redundancy is required for the volume that contains the replica database, specify a number greater than the default value of 1.

Alternatively, create a new volume for use as the snapshot volume as described in [“Creating a Volume for Use as a Full-Sized Instant Snapshot”](#) on page 293.

5. If you added one of more snapshot plexes to the volume in [step 4](#), create a full-sized instant snapshot volume, *snapvol*, by running the following command on the primary host:

```
# vxsnap -g volumedg make source=volume/newvol=snapvol/nmirror=N
```

This version of the `vxsnap make` command uses the `nmirror` attribute to specify how many snapshot plexes of the original volume are to be broken off to form the snapshot volume.



If you created a new volume, *snapvol*, for use as the snapshot volume in [step 4](#), use the following version of the `vxsnap` command to create the snapshot on this volume:

```
# vxsnap -g volumedg make source=volume/snapvol=snapvol
```

Note By default, VxVM attempts to avoid placing snapshot mirrors on a disk that already holds any plexes of a data volume. However, this may be impossible if insufficient space is available in the disk group. In this case, VxVM uses any available space on other disks in the disk group. If the snapshot plexes are placed on disks which are used to hold the plexes of other volumes, this may cause problems when you subsequently attempt to move a snapshot volume into another disk group as described in [“Moving DCO Volumes Between Disk Groups”](#) on page 161. To override the default storage allocation policy, you can use storage attributes to specify explicitly which disks to use for the snapshot plexes. See [“Creating a Volume on Specific Disks”](#) on page 203 for more information.

If a database spans more than one volume, you can specify all the volumes and their snapshot volumes using one command, as shown in this example:

```
# vxsnap -g dbasedg make source=vol1/newvol=snapvol1/nmirror=2 \  
source=vol2/newvol=snapvol2/nmirror=2 \  
source=vol3/newvol=snapvol3/nmirror=2
```

Note This step sets up the snapshot volumes, and starts tracking changes to the original volumes. When you are ready to create a replica database, proceed to [step 6](#).

6. On the primary host, suspend updates to the volume that contains the database tables. The database may have a hot backup mode that allows you to do this by temporarily suspending writes to its tables.
7. On the primary host, refresh the plexes of the snapshot volume using the following command:

```
# vxsnap [-g diskgroup] refresh snapvol source=volume syncing=yes
```

The `syncing=yes` attribute starts a synchronization of the snapshot in the background.

For a database, multiple snapshots can be refreshed in parallel, as shown in this example:

```
# vxsnap -g dbasedg refresh snapvol1 source=vol1 snapvol2 \  
source=vol2 snapvol3 source=vol3 syncing=yes
```

8. On the primary host, if you temporarily suspended updates to the volume by a database in [step 6](#), release all the tables from hot backup mode.
9. The snapshot volume must be completely synchronized before you can move it into another disk group. You can use the `vxsnap syncwait` command to wait for the synchronization to complete as shown here:

```
# vxsnap -g volumedg syncwait snapvol
```

The `vxsnap syncwait` command exits with an exit code of zero when the snapshot volume has been synchronized with the parent volume.

If required, you can use the following command to verify whether the `V_PFLAG_INCOMPLETE` flag is set on a volume:

```
# vxprint [-g diskgroup] -F%incomplete snapvol
```

This command returns the value `off` if synchronization of the volume, *snapvol*, is complete; otherwise, it returns the value `on`.

You can also use the `vxsnap print` command to check on the progress of synchronization as described in “[Displaying Instant Snapshot Information \(vxsnap print\)](#)” on page 291.

10. On the primary host, use the following command to split the snapshot volume into a separate disk group, *snapvoldg*, from the original disk group, *volumedg*:

```
# vxdg split volumedg snapvoldg snapvol
```

11. On the primary host, deport the snapshot volume’s disk group using the following command:

```
# vxdg deport snapvoldg
```

12. On the OHP host where the replica database is to be set up, use the following command to import the snapshot volume’s disk group:

```
# vxdg import snapvoldg
```

13. The snapshot volume is initially disabled following the split. Use the following commands on the OHP host to recover and restart the snapshot volume:

```
# vxrecover -g snapvoldg -m snapvol
```

```
# vxvol -g snapvoldg start snapvol
```

14. On the OHP host, check and mount the snapshot volume. The following are sample commands for checking and mounting a file system:

```
# fsck -F vxfs /dev/vx/rdisk/snapvoldg/snapvol
```

```
# mount -F vxfs /dev/vx/dsk/snapvoldg/snapvol mount_point
```



15. On the OHP host, use the appropriate database commands to recover and start the replica database for its decision support role.

When you want to resynchronize the snapshot volume's data with the primary database, you can refresh the snapshot plexes from the original volume as described below:

1. On the OHP host, shut down the replica database, and use the following command to unmount the snapshot volume:

```
# umount mount_point
```

2. On the OHP host, use the following command to deport the snapshot volume's disk group:

```
# vxdg deport snapvoldg
```

3. On the primary host, re-import the snapshot volume's disk group using the following command:

```
# vxdg import snapvoldg
```

4. On the primary host, use the following command to rejoin the snapshot volume's disk group with the original volume's disk group:

```
# vxdg join snapvoldg volumedg
```

5. The snapshot volume is initially disabled following the join. Use the following commands on the primary host to recover and restart the snapshot volume:

```
# vxrecover -g volumedg -m snapvol
```

```
# vxvol -g volumedg start snapvol
```

The contents of the snapshot volume are now ready to be refreshed.

You can then resume the procedure from [step 6](#) on page 324. The snapshot volume can be split from the disk group when synchronization is again complete.

Administering Hot-Relocation

12

If a volume has a disk I/O failure (for example, the disk has an uncorrectable error), VERITAS Volume Manager (VxVM) can detach the plex involved in the failure. I/O stops on that plex but continues on the remaining plexes of the volume.

If a disk fails completely, VxVM can detach the disk from its disk group. All plexes on the disk are disabled. If there are any unmirrored volumes on a disk when it is detached, those volumes are also disabled.

Note Apparent disk failure may not be due to a fault in the physical disk media or the disk controller, but may instead be caused by a fault in an intermediate or ancillary component such as a cable, host bus adapter, or power supply.

The hot-relocation feature in VxVM automatically detects disk failures, and notifies the system administrator and other nominated users of the failures by electronic mail. Hot-relocation also attempts to use spare disks and free disk space to restore redundancy and to preserve access to mirrored and RAID-5 volumes. For more information, see the section, “[How Hot-Relocation Works](#)” on page 328.

If hot-relocation is disabled or you miss the electronic mail, you can use the `vxprint` command or the graphical user interface to examine the status of the disks. You may also see driver error messages on the console or in the system messages file.

Failed disks must be removed and replaced manually as described in “[Removing and Replacing Disks](#)” on page 90.

For more information about recovering volumes and their data after hardware failure, see the *VERITAS Volume Manager Troubleshooting Guide*.



How Hot-Relocation Works

Hot-relocation allows a system to react automatically to I/O failures on redundant (mirrored or RAID-5) VxVM objects, and to restore redundancy and access to those objects. VxVM detects I/O failures on objects and relocates the affected subdisks to disks designated as spare disks or to free space within the disk group. VxVM then reconstructs the objects that existed before the failure and makes them redundant and accessible again.

When a partial disk failure occurs (that is, a failure affecting only some subdisks on a disk), redundant data on the failed portion of the disk is relocated. Existing volumes on the unaffected portions of the disk remain accessible.

Note Hot-relocation is only performed for redundant (mirrored or RAID-5) subdisks on a failed disk. Non-redundant subdisks on a failed disk are not relocated, but the system administrator is notified of their failure.

Hot-relocation is enabled by default and takes effect without the intervention of the system administrator when a failure occurs.

The hot-relocation daemon, `vxrelocd`, detects and reacts to VxVM events that signify the following types of failures:

- ◆ disk failure—this is normally detected as a result of an I/O failure from a VxVM object. VxVM attempts to correct the error. If the error cannot be corrected, VxVM tries to access configuration information in the private region of the disk. If it cannot access the private region, it considers the disk failed.
- ◆ plex failure—this is normally detected as a result of an uncorrectable I/O error in the plex (which affects subdisks within the plex). For mirrored volumes, the plex is detached.
- ◆ RAID-5 subdisk failure—this is normally detected as a result of an uncorrectable I/O error. The subdisk is detached.

When `vxrelocd` detects such a failure, it performs the following steps:

1. `vxrelocd` informs the system administrator (and other nominated users, see [“Modifying the Behavior of Hot-Relocation”](#) on page 344) by electronic mail of the failure and which VxVM objects are affected. See [“Partial Disk Failure Mail Messages”](#) on page 331 and [“Complete Disk Failure Mail Messages”](#) on page 332 for more information.
2. `vxrelocd` next determines if any subdisks can be relocated. `vxrelocd` looks for suitable space on disks that have been reserved as hot-relocation spares (marked `spare`) in the disk group where the failure occurred. It then relocates the subdisks to use this space.



3. If no spare disks are available or additional space is needed, `vxrelocd` uses free space on disks in the same disk group, except those disks that have been excluded for hot-relocation use (marked `nohotuse`). When `vxrelocd` has relocated the subdisks, it reattaches each relocated subdisk to its plex.
4. Finally, `vxrelocd` initiates appropriate recovery procedures. For example, recovery includes mirror resynchronization for mirrored volumes or data recovery for RAID-5 volumes. It also notifies the system administrator of the hot-relocation and recovery actions that have been taken.

If relocation is not possible, `vxrelocd` notifies the system administrator and takes no further action.

Note Hot-relocation does not guarantee the same layout of data or the same performance after relocation. The system administrator can make configuration changes after hot-relocation occurs.

Relocation of failing subdisks is not possible in the following cases:

- ◆ The failing subdisks are on non-redundant volumes (that is, volumes of types other than mirrored or RAID-5).
- ◆ There are insufficient spare disks or free disk space in the disk group.
- ◆ The only available space is on a disk that already contains a mirror of the failing plex.
- ◆ The only available space is on a disk that already contains the RAID-5 log plex or one of its healthy subdisks, failing subdisks in the RAID-5 plex cannot be relocated.
- ◆ If a mirrored volume has a dirty region logging (DRL) log subdisk as part of its data plex, failing subdisks belonging to that plex cannot be relocated.
- ◆ If a RAID-5 volume log plex or a mirrored volume DRL log plex fails, a new log plex is created elsewhere. There is no need to relocate the failed subdisks of log plex.

See the `vxrelocd(1M)` manual page for more information about the hot-relocation daemon.

“[Example of Hot-Relocation for a Subdisk in a RAID-5 Volume](#)” on page 330 illustrates the hot-relocation process in the case of the failure of a single subdisk of a RAID-5 volume.



Example of Hot-Relocation for a Subdisk in a RAID-5 Volume

- a) Disk group contains five disks. Two RAID-5 volumes are configured across four of the disks. One spare disk is available for hot-relocation.

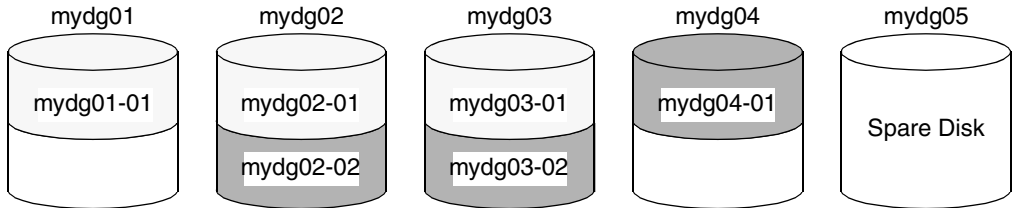

- b) Subdisk mydg02-01 in one RAID-5 volume fails. Hot-relocation replaces it with subdisk mydg05-0 that it has created on the spare disk, and then initiates recovery of the RAID-5 volume.

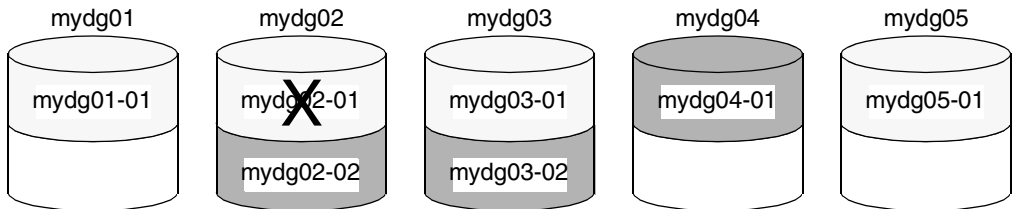

- c) RAID-5 recovery recreates subdisk mydg02-01's data and parity on subdisk mydg05-01 from the data and parity information remaining on subdisks mydg01-01 and mydg03-01.

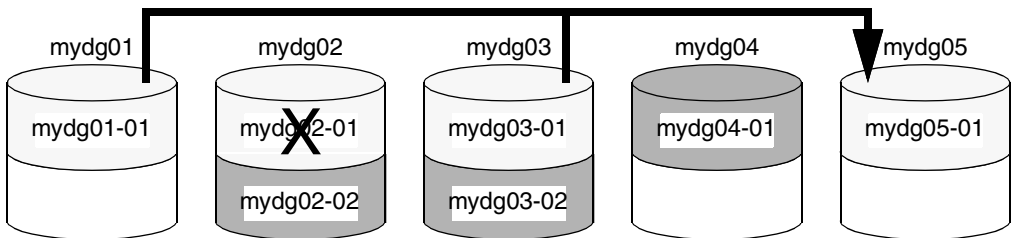

Partial Disk Failure Mail Messages

If hot-relocation is enabled when a plex or disk is detached by a failure, mail indicating the failed objects is sent to `root`. If a partial disk failure occurs, the mail identifies the failed plexes. For example, if a disk containing mirrored volumes fails, you can receive mail information as shown in the following example:

```
To: root
Subject: Volume Manager failures on host teal
Failures have been detected by the VERITAS Volume Manager:

failed plexes:
home-02
src-02
```

See “[Modifying the Behavior of Hot-Relocation](#)” on page 344 for information on how to send the mail to users other than `root`.

You can determine which disk is causing the failures in the above example message by using the following command:

```
# vxstat -g mydg -s -ff home-02 src-02
```

The `-s` option asks for information about individual subdisks, and the `-ff` option displays the number of failed read and write operations. The following output display is typical:

TYP NAME	FAILED	
	READS	WRITES
sd mydg01-04	0	0
sd mydg01-06	0	0
sd mydg02-03	1	0
sd mydg02-04	1	0

This example shows failures on reading from subdisks `mydg02-03` and `mydg02-04` of disk `mydg02`.

Hot-relocation automatically relocates the affected subdisks and initiates any necessary recovery procedures. However, if relocation is not possible or the hot-relocation feature is disabled, you must investigate the problem and attempt to recover the plexes. Errors can be caused by cabling failures, so check the cables connecting your disks to your system. If there are obvious problems, correct them and recover the plexes using the following command:

```
# vxrecover -b -g mydg home src
```

This starts recovery of the failed plexes in the background (the command prompt reappears before the operation completes). If an error message appears later, or if the plexes become detached again and there are no obvious cabling failures, replace the disk (see “[Removing and Replacing Disks](#)” on page 90).



Complete Disk Failure Mail Messages

If a disk fails completely and hot-relocation is enabled, the mail message lists the disk that failed and all plexes that use the disk. For example, you can receive mail as shown in this example display:

```
To: root
Subject: Volume Manager failures on host teal

Failures have been detected by the VERITAS Volume Manager:

failed disks:
mydg02

failed plexes:
home-02
src-02
mkting-01

failing disks:
mydg02
```

This message shows that `mydg02` was detached by a failure. When a disk is detached, I/O cannot get to that disk. The plexes `home-02`, `src-02`, and `mkting-01` were also detached (probably because of the failure of the disk).

As described in [“Partial Disk Failure Mail Messages”](#) on page 331, the problem can be a cabling error. If the problem is not a cabling error, replace the disk (see [“Removing and Replacing Disks”](#) on page 90).

How Space is Chosen for Relocation

A spare disk must be initialized and placed in a disk group as a spare before it can be used for replacement purposes. If no disks have been designated as spares when a failure occurs, VxVM automatically uses any available free space in the disk group in which the failure occurs. If there is not enough spare disk space, a combination of spare space and free space is used.

The free space used in hot-relocation must not have been excluded from hot-relocation use. Disks can be excluded from hot-relocation use by using `vxdiskadm`, `vxedit` or the VERITAS Enterprise Administrator (VEA).

You can designate one or more disks as hot-relocation spares within each disk group. Disks can be designated as spares by using `vxdiskadm`, `vxedit`, or the VEA. Disks designated as spares do not participate in the free space model and should not have storage space allocated on them.

When selecting space for relocation, hot-relocation preserves the redundancy characteristics of the VxVM object to which the relocated subdisk belongs. For example, hot-relocation ensures that subdisks from a failed plex are not relocated to a disk containing a mirror of the failed plex. If redundancy cannot be preserved using any available spare disks and/or free space, hot-relocation does not take place. If relocation is not possible, the system administrator is notified and no further action is taken.

From the eligible disks, hot-relocation attempts to use the disk that is “closest” to the failed disk. The value of “closeness” depends on the controller, target, and disk number of the failed disk. A disk on the same controller as the failed disk is closer than a disk on a different controller. A disk under the same target as the failed disk is closer than one on a different target.

Hot-relocation tries to move all subdisks from a failing drive to the same destination disk, if possible.

When hot-relocation takes place, the failed subdisk is removed from the configuration database, and VxVM ensures that the disk space used by the failed subdisk is not recycled as free space.

Configuring a System for Hot-Relocation

By designating spare disks and making free space on disks available for use by hot relocation, you can control how disk space is used for relocating subdisks in the event of a disk failure. If the combined free space and space on spare disks is not sufficient or does not meet the redundancy constraints, the subdisks are not relocated.

- ◆ To find out which disks are spares or are excluded from hot-relocation, see [“Displaying Spare Disk Information”](#) on page 334.

You can prepare for hot-relocation by designating one or more disks per disk group as hot-relocation spares.

- ◆ To designate a disk as being a hot-relocation spare for a disk group, see [“Marking a Disk as a Hot-Relocation Spare”](#) on page 335.
- ◆ To remove a disk from use as a hot-relocation spare, see [“Removing a Disk from Use as a Hot-Relocation Spare”](#) on page 336.

If no spares are available at the time of a failure or if there is not enough space on the spares, free space on disks in the same disk group as where the failure occurred is automatically used, unless it has been excluded from hot-relocation use.

- ◆ To exclude a disk from hot-relocation use, see [“Excluding a Disk from Hot-Relocation Use”](#) on page 337.
- ◆ To make a disk available for hot-relocation use, see [“Making a Disk Available for Hot-Relocation Use”](#) on page 338.



Depending on the locations of the relocated subdisks, you can choose to move them elsewhere after hot-relocation occurs (see “[Configuring Hot-Relocation to Use Only Spare Disks](#)” on page 339).

After a successful relocation, remove and replace the failed disk as described in “[Removing and Replacing Disks](#)” on page 90).

Displaying Spare Disk Information

Use the following command to display information about spare disks that are available for relocation:

```
# vxdg [-g diskgroup] spare
```

The following is example output:

GROUP	DISK	DEVICE	TAG	OFFSET	LENGTH	FLAGS
mydg	mydg02	c0t2d0	c0t2d0	0	658007	s

Here `mydg02` is the only disk designated as a spare in the `mydg` disk group. The `LENGTH` field indicates how much spare space is currently available on `mydg02` for relocation.

The following commands can also be used to display information about disks that are currently designated as spares:

- ◆ `vxdisk list` lists disk information and displays spare disks with a `spare` flag.
- ◆ `vxprint` lists disk and other information and displays spare disks with a `SPARE` flag.
- ◆ The `list` menu item on the `vxdiskadm` main menu lists all disks including spare disks.

Marking a Disk as a Hot-Relocation Spare

Hot-relocation allows the system to react automatically to I/O failure by relocating redundant subdisks to other disks. Hot-relocation then restores the affected VxVM objects and data. If a disk has already been designated as a spare in the disk group, the subdisks from the failed disk are relocated to the spare disk. Otherwise, any suitable free space in the disk group is used.

To designate a disk as a hot-relocation spare, enter the following command:

```
# vxedit [-g diskgroup] set spare=on diskname
```

where *diskname* is the disk media name.

For example, to designate `mydg01` as a spare in the disk group, `mydg`, enter the following command:

```
# vxedit -g mydg set spare=on mydg01
```

You can use the `vxdisk list` command to confirm that this disk is now a spare; `mydg01` should be listed with a `spare` flag.

Any VM disk in this disk group can now use this disk as a spare in the event of a failure. If a disk fails, hot-relocation automatically occurs (if possible). You are notified of the failure and relocation through electronic mail. After successful relocation, you may want to replace the failed disk.

Alternatively, you can use `vxdiskadm` to designate a disk as a hot-relocation spare:

1. Select menu item 11 (Mark a disk as a spare for a disk group) from the `vxdiskadm` main menu.
2. At the following prompt, enter a disk media name (such as `mydg01`):

```
Menu: VolumeManager/Disk/MarkSpareDisk
```

```
Use this operation to mark a disk as a spare for a disk group.
This operation takes, as input, a disk name. This is the same
name that you gave to the disk when you added the disk to the
disk group.
```

```
Enter disk name [<disk>,list,q,?] mydg01
```

The following notice is displayed when the disk has been marked as spare:

```
VxVM NOTICE V-5-2-219 Marking of mydg01 in mydg as a spare disk is
complete.
```

3. At the following prompt, indicate whether you want to add more disks as spares (**y**) or return to the `vxdiskadm` main menu (**n**):

```
Mark another disk as a spare? [y,n,q,?] (default: n)
```



Any VM disk in this disk group can now use this disk as a spare in the event of a failure. If a disk fails, hot-relocation should automatically occur (if possible). You should be notified of the failure and relocation through electronic mail. After successful relocation, you may want to replace the failed disk.

Removing a Disk from Use as a Hot-Relocation Spare

While a disk is designated as a spare, the space on that disk is not used for the creation of VxVM objects within its disk group. If necessary, you can free a spare disk for general use by removing it from the pool of hot-relocation disks.

To remove a spare from the hot-relocation pool, use the following command:

```
# vxedit [-g diskgroup] set spare=off diskname
```

where *diskname* is the disk media name.

For example, to make mydg01 available for normal use in the disk group, mydg, use the following command:

```
# vxedit -g mydg set spare=off mydg01
```

Alternatively, you can use vxdiskadm to remove a disk from the hot-relocation pool:

1. Select menu item 12 (Turn off the spare flag on a disk) from the vxdiskadm main menu.
2. At the following prompt, enter the disk media name of a spare disk (such as mydg01):

```
Menu: VolumeManager/Disk/UnmarkSpareDisk
```

Use this operation to turn off the spare flag on a disk. This operation takes, as input, a disk name. This is the same name that you gave to the disk when you added the disk to the disk group.

```
Enter disk name [<disk>,list,q,?] mydg01
```

The following confirmation is displayed:

```
VxVM NOTICE V-5-2-143 Disk mydg01 in mydg no longer marked as a spare disk.
```

3. At the following prompt, indicate whether you want to disable more spare disks (**y**) or return to the vxdiskadm main menu (**n**):

```
Turn-off spare flag on another disk? [y,n,q,?] (default: n)
```

Excluding a Disk from Hot-Relocation Use

To exclude a disk from hot-relocation use, use the following command:

```
# vxedit [-g diskgroup] set nohotuse=on diskname
```

where *diskname* is the disk media name.

Alternatively, using vxdiskadm:

1. Select menu item 15 (Exclude a disk from hot-relocation use) from the vxdiskadm main menu.
2. At the following prompt, enter the disk media name (such as mydg01):

```
Exclude a disk from hot-relocation use
Menu: VolumeManager/Disk/UnmarkSpareDisk
```

Use this operation to exclude a disk from hot-relocation use. This operation takes, as input, a disk name. This is the same name that you gave to the disk when you added the disk to the disk group.

```
Enter disk name [<disk>,list,q,?] mydg01
```

The following confirmation is displayed:

```
VxVM INFO V-5-2-925 Excluding mydg01 in mydg from hot-relocation
use is complete.
```

3. At the following prompt, indicate whether you want to add more disks to be excluded from hot-relocation (**y**) or return to the vxdiskadm main menu (**n**):

```
Exclude another disk from hot-relocation use? [y,n,q,?]
(default: n)
```



Making a Disk Available for Hot-Relocation Use

Free space is used automatically by hot-relocation in case spare space is not sufficient to relocate failed subdisks. You can limit this free space usage by hot-relocation by specifying which free disks should not be touched by hot-relocation. If a disk was previously excluded from hot-relocation use, you can undo the exclusion and add the disk back to the hot-relocation pool.

To make a disk available for hot-relocation use, use the following command:

```
# vxedit [-g diskgroup] set nohotuse=off diskname
```

Alternatively, using vxdiskadm:

1. Select menu item 16 (Make a disk available for hot-relocation use) from the vxdiskadm main menu.
2. At the following prompt, enter the disk media name (such as mydg01):

```
Menu: VolumeManager/Disk/UnmarkSpareDisk
```

```
Use this operation to make a disk available for hot-relocation use.
This only applies to disks that were previously excluded from
hot-relocation use. This operation takes, as input, a disk name.
This is the same name that you gave to the disk when you added the
disk to the disk group.
```

```
Enter disk name [<disk>,list,q,?] mydg01
```

The following confirmation is displayed:

```
V-5-2-932 Making mydg01 in mydg available for hot-relocation use is
complete.
```

3. At the following prompt, indicate whether you want to add more disks to be excluded from hot-relocation (**y**) or return to the vxdiskadm main menu (**n**):

```
Make another disk available for hot-relocation use? [y,n,q,?]
(default: n)
```

Configuring Hot-Relocation to Use Only Spare Disks

If you want VxVM to use only spare disks for hot-relocation, add the following line to the file `/etc/default/vxassist`:

```
spare=only
```

If not enough storage can be located on disks marked as spare, the relocation fails. Any free space on non-spare disks is not used.

Moving and Unrelocating Subdisks

When hot-relocation occurs, subdisks are relocated to spare disks and/or available free space within the disk group. The new subdisk locations may not provide the same performance or data layout that existed before hot-relocation took place. You can move the relocated subdisks (after hot-relocation is complete) to improve performance.

You can also move the relocated subdisks off the spare disks to keep the spare disk space free for future hot-relocation needs. Another reason for moving subdisks is to recreate the configuration that existed before hot-relocation occurred.

During hot-relocation, one of the electronic mail messages sent to `root` is shown in the following example:

```
To: root
Subject: Volume Manager failures on host teal

Attempting to relocate subdisk mydg02-03 from plex home-02.
Dev_offset 0 length 1164 dm_name mydg02 da_name c0t5d0.
The available plex home-01 will be used to recover the data.
```

This message has information about the subdisk before relocation and can be used to decide where to move the subdisk after relocation.

Here is an example message that shows the new location for the relocated subdisk:

```
To: root
Subject: Attempting VxVM relocation on host teal

Volume home Subdisk mydg02-03 relocated to mydg05-01,
but not yet recovered.
```

Before you move any relocated subdisks, fix or replace the disk that failed (as described in [“Removing and Replacing Disks”](#) on page 90). Once this is done, you can move a relocated subdisk back to the original disk as described in the following sections.

Caution During subdisk move operations, RAID-5 volumes are not redundant.



Moving and Unrelocating Subdisks Using vxdiskadm

To move the hot-relocated subdisks back to the disk where they originally resided after the disk has been replaced following a failure, use the following procedure:

1. Select menu item 14 (Unrelocate subdisks back to a disk) from the vxdiskadm main menu.

2. This option prompts for the original disk media name first.

Enter the disk media name where the hot-relocated subdisks originally resided at the following prompt:

```
Enter the original disk name [<disk>,list,q,?]
```

If there are no hot-relocated subdisks in the system, vxdiskadm displays `Currently there are no hot-relocated disks`, and asks you to press `Return` to continue.

3. You are next asked if you want to move the subdisks to a destination disk other than the original disk.

```
While unrelocating the subdisks, you can choose to move the
subdisks to a different disk from the original disk.
Unrelocate to a new disk [y,n,q,?] (default: n)
```

4. If moving subdisks to their original offsets is not possible, you can choose to unrelocate the subdisks forcibly to the specified disk, but not necessarily to the same offsets.

```
Use -f option to unrelocate the subdisks if moving to the exact
offset fails? [y,n,q,?] (default: n)
```

5. If you entered **y** at step 4 to unrelocate the subdisks forcibly, enter **y** or press `Return` at the following prompt to confirm the operation:

```
Requested operation is to move all the subdisks which were
hot-relocated from mydg10 back to mydg10 of disk group mydg.
Continue with operation? [y,n,q,?] (default: y)
```

A status message is displayed at the end of the operation.

```
VxVM INFO V-5-2-954 Unrelocate to disk mydg10 is complete.
```

As an alternative to this procedure, use either the `vxassist` command or the `vxunreloc` command directly, as described in [“Moving and Unrelocating Subdisks Using vxassist”](#) on page 341 and [“Moving and Unrelocating Subdisks Using vxunreloc”](#) on page 341.

Moving and Unrelocating Subdisks Using vxassist

You can use the `vxassist` command to move and unrelocate subdisks. For example, to move the relocated subdisks on `mydg05` belonging to the volume `home` back to `mydg02`, enter the following command:

```
# vxassist -g mydg move home !mydg05 mydg02
```

Here, `!mydg05` specifies the current location of the subdisks, and `mydg02` specifies where the subdisks should be relocated.

If the volume is enabled, subdisks within detached or disabled plexes, and detached log or RAID-5 subdisks, are moved without recovery of data.

If the volume is not enabled, subdisks within STALE or OFFLINE plexes, and stale log or RAID-5 subdisks, are moved without recovery. If there are other subdisks within a non-enabled volume that require moving, the relocation fails.

For enabled subdisks in enabled plexes within an enabled volume, data is moved to the new location, without loss of either availability or redundancy of the volume.

Moving and Unrelocating Subdisks Using vxunreloc

VxVM hot-relocation allows the system to automatically react to I/O failures on a redundant VxVM object at the subdisk level and then take necessary action to make the object available again. This mechanism detects I/O failures in a subdisk, relocates the subdisk, and recovers the plex associated with the subdisk. After the disk has been replaced, `vxunreloc` allows you to restore the system back to the configuration that existed before the disk failure. `vxunreloc` allows you to move the hot-relocated subdisks back onto a disk that was replaced due to a failure.

When `vxunreloc` is invoked, you must specify the disk media name where the hot-relocated subdisks originally resided. When `vxunreloc` moves the subdisks, it moves them to the original offsets. If you try to unrelocate to a disk that is smaller than the original disk that failed, `vxunreloc` does nothing except return an error.

`vxunreloc` provides an option to move the subdisks to a different disk from where they were originally relocated. It also provides an option to unrelocate subdisks to a different offset as long as the destination disk is large enough to accommodate all the subdisks.

If `vxunreloc` cannot replace the subdisks back to the same original offsets, a `force` option is available that allows you to move the subdisks to a specified disk without using the original offsets. Refer to the `vxunreloc(1M)` manual page for more information.

The examples in the following sections demonstrate the use of `vxunreloc`.



Moving Hot-Relocated Subdisks back to their Original Disk

Assume that `mydg01` failed and all the subdisks were relocated. After `mydg01` is replaced, `vxunreloc` can be used to move all the hot-relocated subdisks back to `mydg01`.

```
# vxunreloc -g mydg mydg01
```

Moving Hot-Relocated Subdisks to a Different Disk

The `vxunreloc` utility provides the `-n` option to move the subdisks to a different disk from where they were originally relocated.

Assume that `mydg01` failed, and that all of the subdisks that resided on it were hot-relocated to other disks. `vxunreloc` provides an option to move the subdisks to a different disk from where they were originally relocated. After the disk is repaired, it is added back to the disk group using a different name, e.g, `mydg05`. If you want to move all the hot-relocated subdisks back to the new disk, the following command can be used:

```
# vxunreloc -g mydg -n mydg05 mydg01
```

The destination disk should have at least as much storage capacity as was in use on the original disk. If there is not enough space, the `unrelocate` operation will fail and none of the subdisks will be moved.

Forcing Hot-Relocated Subdisks to Accept Different Offsets

By default, `vxunreloc` attempts to move hot-relocated subdisks to their original offsets. However, `vxunreloc` fails if any subdisks already occupy part or all of the area on the destination disk. In such a case, you have two choices:

- ◆ Move the existing subdisks somewhere else, and then re-run `vxunreloc`.
- ◆ Use the `-f` option provided by `vxunreloc` to move the subdisks to the destination disk, but leave it to `vxunreloc` to find the space on the disk. As long as the destination disk is large enough so that the region of the disk for storing subdisks can accommodate all subdisks, all the hot-relocated subdisks will be unrelocated without using the original offsets.

Assume that `mydg01` failed and the subdisks were relocated and that you want to move the hot-relocated subdisks to `mydg05` where some subdisks already reside. You can use the force option to move the hot-relocated subdisks to `mydg05`, but not to the exact offsets:

```
# vxunreloc -g mydg -f -n mydg05 mydg01
```

Examining Which Subdisks Were Hot-Relocated from a Disk

If a subdisk was hot relocated more than once due to multiple disk failures, it can still be unrelocated back to its original location. For instance, if `mydg01` failed and a subdisk named `mydg01-01` was moved to `mydg02`, and then `mydg02` experienced disk failure, all of the subdisks residing on it, including the one which was hot-relocated to it, will be moved again. When `mydg02` was replaced, a `vxunreloc` operation for `mydg02` will do nothing to the hot-relocated subdisk `mydg01-01`. However, a replacement of `mydg01` followed by a `vxunreloc` operation, moves `mydg01-01` back to `mydg01` if `vxunreloc` is run immediately after the replacement.

After the disk that experienced the failure is fixed or replaced, `vxunreloc` can be used to move all the hot-relocated subdisks back to the disk. When a subdisk is hot-relocated, its original disk-media name and the offset into the disk, are saved in the configuration database. When a subdisk is moved back to the original disk or to a new disk using `vxunreloc`, the information is erased. The original disk-media name and the original offset are saved in the subdisk records. To print all of the subdisks that were hot-relocated from `mydg01` in the `mydg` disk group, use the following command:

```
# vxprint -g mydg -se 'sd_orig_dmname="mydg01"'
```

Restarting vxunreloc After Errors

`vxunreloc` moves subdisks in three phases:

1. `vxunreloc` creates as many subdisks on the specified destination disk as there are subdisks to be unrelocated. The string `UNRELOC` is placed in the `comment` field of each subdisk record.

Creating the subdisk is an *all-or-nothing* operation. If `vxunreloc` cannot create all the subdisks successfully, none are created, and `vxunreloc` exits.

2. `vxunreloc` moves the data from each subdisk to the corresponding newly created subdisk on the destination disk.
3. When all subdisk data moves have been completed successfully, `vxunreloc` sets the `comment` field to the null string for each subdisk on the destination disk whose `comment` field is currently set to `UNRELOC`.

The `comment` fields of all the subdisks on the destination disk remain marked as `UNRELOC` until phase 3 completes. If its execution is interrupted, `vxunreloc` can subsequently re-use subdisks that it created on the destination disk during a previous execution, but it does not use any data that was moved to the destination disk.

If a subdisk data move fails, `vxunreloc` displays an error message and exits. Determine the problem that caused the move to fail, and fix it before re-executing `vxunreloc`.



If the system goes down after the new subdisks are created on the destination disk, but before all the data has been moved, re-execute `vxunreloc` when the system has been rebooted.

Caution Do not modify the string `UNRELOC` in the comment field of a subdisk record.

Modifying the Behavior of Hot-Relocation

Hot-relocation is turned on as long as `vxrelocd` is running. You leave hot-relocation turned on so that you can take advantage of this feature if a failure occurs. However, if you choose to disable this feature (perhaps because you do not want the free space on some of your disks to be used for relocation), prevent `vxrelocd` from starting at system startup time.

You can stop hot-relocation at any time by killing the `vxrelocd` process (this should not be done while a hot-relocation attempt is in progress).

You can make some minor changes to the way `vxrelocd` behaves by either editing the `vxrelocd` line in the startup file that invokes `vxrelocd` (`/sbin/init.d/vxvm-recover`), or by killing the existing `vxrelocd` process and restarting it with different options. After making changes to the way `vxrelocd` is invoked in the startup file, you need to reboot the system so that the changes go into effect. If you choose to kill and restart the daemon instead, make sure that hot-relocation is not in progress when you kill the `vxrelocd` process. You should also restart the daemon immediately so that hot-relocation can take effect if a failure occurs.

You can alter `vxrelocd` behavior as follows:

- ❖ To prevent `vxrelocd` starting, comment out the entry that invokes it in the startup file:

```
# nohup vxrelocd root &
```
- ❖ By default, `vxrelocd` sends electronic mail to `root` when failures are detected and relocation actions are performed. You can instruct `vxrelocd` to notify additional users by adding the appropriate user names as shown here:

```
nohup vxrelocd root user1 user2 &
```

- ❖ To reduce the impact of recovery on system performance, you can instruct `vxrelocd` to increase the delay between the recovery of each region of the volume, as shown in the following example:

```
nohup vxrelocd -o slow[=IOdelay] root &
```

where the optional *IOdelay* value indicates the desired delay in milliseconds. The default value for the delay is 250 milliseconds.

When executing `vxrelocd` manually, either include `/etc/vx/bin` in your `PATH` or specify `vxrelocd`'s absolute pathname, for example:

```
# PATH=/etc/vx/bin:$PATH  
# export PATH  
# nohup vxrelocd root &
```

Alternatively, you can use the following command:

```
# nohup /etc/vx/bin/vxrelocd root user1 user2 &
```

See the `vxrelocd(1M)` manual page for more information.





A cluster consists of a number of hosts or *nodes* that share a set of disks. The main benefits of cluster configurations are:

- ◆ *Availability*—If one node fails, the other nodes can still access the shared disks. When configured with suitable software, mission-critical applications can continue running by transferring their execution to a standby node in the cluster. This ability to provide continuous uninterrupted service by switching to redundant hardware is commonly termed *failover*.

Failover is transparent to users and high-level applications for database and file-sharing. You must configure cluster management software, such as VERITAS Cluster Server (VCS), to monitor systems and services, and to restart applications on another node in the event of either hardware or software failure. VCS also allows you to perform general administration tasks such as making nodes join or leave a cluster.

- ◆ *Off-host processing*—Clusters can reduce contention for system resources by performing activities such as backup, decision support and report generation on the more lightly loaded nodes of the cluster. This allows businesses to derive enhanced value from their investment in cluster systems.

The cluster functionality of VERITAS Volume Manager (CVM) allows up to 16 nodes in a cluster to simultaneously access and manage a set of disks under VxVM control (VM disks). The same logical view of disk configuration and any changes to this is available on all the nodes. When the cluster functionality is enabled, all the nodes in the cluster can share VxVM objects. This chapter discusses the cluster functionality that is provided with VxVM.

Note You need an additional license to use this feature.

This chapter does not discuss VERITAS Cluster File System (CFS) nor cluster management software such as VERITAS Cluster Server (VCS). Such products are separately licensed, and are not included with VERITAS Volume Manager. See the documentation provided with those products for more information about them.

For additional information about using the Dynamic Multipathing (DMP) feature of VxVM in a clustered environment, see “[DMP in a Clustered Environment](#)” on page 105.



Overview of Cluster Volume Management

In recent years, tightly coupled cluster systems have become increasingly popular in the realm of enterprise-scale mission-critical data processing. The primary advantage of clusters is protection against hardware failure. Should the primary node fail or otherwise become unavailable, applications can continue to run by transferring their execution to standby nodes in the cluster. This ability to provide continuous availability of service by switching to redundant hardware is commonly termed *failover*.

Another major advantage of clustered systems is their ability to reduce contention for system resources caused by activities such as backup, decision support and report generation. Businesses can derive enhanced value from their investment in cluster systems by performing such operations on lightly loaded nodes in the cluster rather than on the heavily loaded nodes that answer requests for service. This ability to perform some operations on the lightly loaded nodes is commonly termed *load balancing*.

The cluster functionality of VxVM works together with the *cluster monitor* daemon that is provided by VCS or by the host operating system. When configured correctly, the cluster monitor informs VxVM of changes in cluster membership. Each node starts up independently and has its own cluster monitor plus its own copies of the operating system and VxVM with support for cluster functionality. When a node *joins* a cluster, it gains access to shared disk groups and volumes. When a node *leaves* a cluster, it no longer has access to these shared objects. A node joins a cluster when the cluster monitor is started on that node.

Caution The cluster functionality of VxVM is supported only when used in conjunction with a cluster monitor that has been configured correctly to work with VxVM.

“[Example of a 4-Node Cluster](#)” on page 349 illustrates a simple cluster arrangement consisting of four nodes with similar or identical hardware characteristics (CPUs, RAM and host adapters), and configured with identical software (including the operating system). The nodes are fully connected by a private network and they are also separately connected to shared external storage (either disk arrays or JBODs: *just a bunch of disks*) via SCSI or Fibre Channel.

Note In this example, each node has two independent paths to the disks, which are configured in one or more cluster-shareable disk groups. Multiple paths provide resilience against failure of one of the paths, but this is not a requirement for cluster configuration. Disks may also be connected by single paths.

The private network allows the nodes to share information about system resources and about each other’s state. Using the private network, any node can recognize which other nodes are currently active, which are joining or leaving the cluster, and which have failed. The private network requires at least two communication channels to provide redundancy against one of the channels failing. If only one channel were used, its failure would be indistinguishable from node failure—a condition known as *network partitioning*.

Example of a 4-Node Cluster

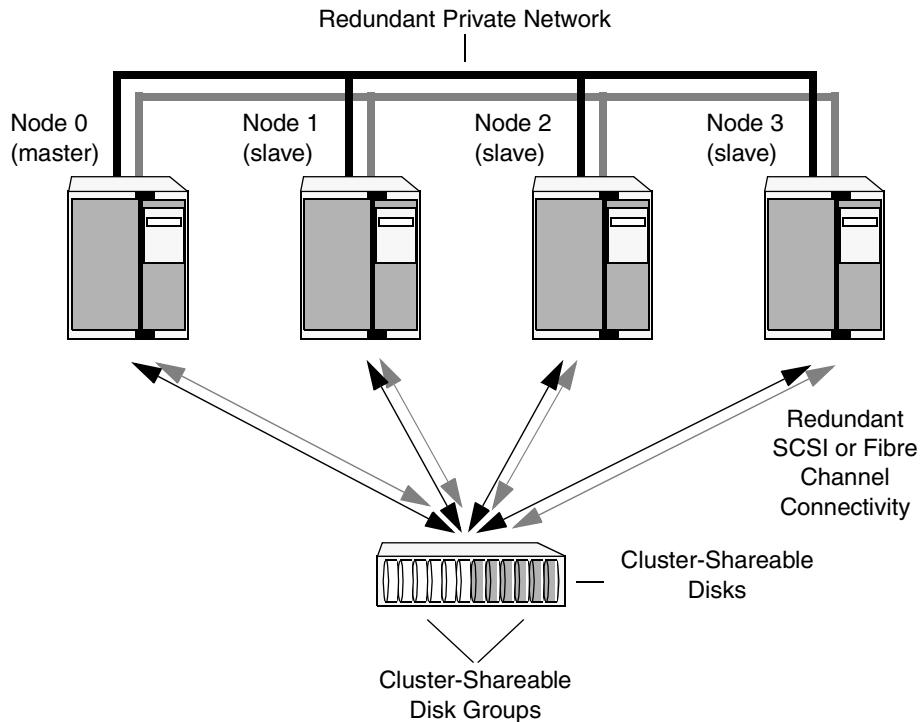

To the cluster monitor, all nodes are the same. VxVM objects configured within shared disk groups can potentially be accessed by all nodes that join the cluster. However, the cluster functionality of VxVM requires that one node act as the *master node*; all other nodes in the cluster are *slave nodes*. Any node is capable of being the master node, and it is responsible for coordinating certain VxVM activities.

Note You must run commands that configure or reconfigure VxVM objects *on the master node*. Tasks that must be initiated from the master node include setting up shared disk groups, creating and reconfiguring volumes, and performing snapshot operations.

VxVM determines that the first node to join a cluster performs the function of master node. If the master node leaves a cluster, one of the slave nodes is chosen to be the new master. In “[Example of a 4-Node Cluster](#),” node 0 is the master node and nodes 1, 2 and 3 are slave nodes.



Private and Shared Disk Groups

Two types of disk groups are defined:

- ◆ *Private disk groups*—belong to only one node. A private disk group is only imported by one system. Disks in a private disk group may be physically accessible from one or more systems, but access is restricted to one system only. The boot disk group (usually aliased by the reserved disk group name `bootdg`) is always a private disk group.
- ◆ *Shared disk groups*—shared by all nodes. A shared (or *cluster-shareable*) disk group is imported by all cluster nodes. Disks in a shared disk group must be physically accessible from all systems that may join the cluster.

In a cluster, most disk groups are shared. Disks in a shared disk group are accessible from all nodes in a cluster, allowing applications on multiple cluster nodes to simultaneously access the same disk. A volume in a shared disk group can be simultaneously accessed by more than one node in the cluster, subject to licensing and disk group activation mode restrictions.

You can use the `vxchg` command to designate a disk group as cluster-shareable as described in “[Importing Disk Groups as Shared](#)” on page 373. When a disk group is imported as cluster-shareable for one node, each disk header is marked with the cluster ID. As each node subsequently joins the cluster, it recognizes the disk group as being cluster-shareable and imports it. As system administrator, you can also import or deport a shared disk group at any time; the operation takes place in a distributed fashion on all nodes.

Each physical disk is marked with a unique disk ID. When cluster functionality for VxVM starts on the master, it imports all shared disk groups (except for any that have the `noautoimport` attribute set). When a slave tries to join a cluster, the master sends it a list of the disk IDs that it has imported, and the slave checks to see if it can access them all. If the slave cannot access one of the listed disks, it abandons its attempt to join the cluster. If it can access all of the listed disks, it imports the same shared disk groups as the master and joins the cluster. When a node leaves the cluster, it deports all its imported shared disk groups, but they remain imported on the surviving nodes.

Reconfiguring a shared disk group is performed with the cooperation of all nodes. Configuration changes to the disk group happen simultaneously on all nodes and the changes are identical. Such changes are *atomic* in nature, which means that they either occur simultaneously on all nodes or not at all.

Whether all members of the cluster have simultaneous read and write access to a cluster-shareable disk group depends on its *activation mode* setting as discussed in “[Activation Modes of Shared Disk Groups](#).” The data contained in a cluster-shareable disk group is available as long as at least one node is active in the cluster. The failure of a cluster node does not affect access by the remaining active nodes. Regardless of which node accesses a cluster-shareable disk group, the configuration of the disk group looks the same.

Note Applications running on each node can access the data on the VM disks simultaneously. VxVM does not protect against simultaneous writes to shared volumes by more than one node. It is assumed that applications control consistency (by using a distributed lock manager, for example).

Activation Modes of Shared Disk Groups

A shared disk group must be activated on a node in order for the volumes in the disk group to become accessible for application I/O from that node. The ability of applications to read from or to write to volumes is dictated by the activation mode of a shared disk group. Valid activation modes for a shared disk group are `exclusive-write`, `read-only`, `shared-read`, `shared-write`, and `off` (inactive). These activation modes are described in detail in the table “[Activation Modes for Shared Disk Groups](#).”

Note The default activation mode for shared disk groups is `off` (inactive).

Special uses of clusters, such as high availability (HA) applications and off-host backup, can use disk group activation to explicitly control volume access from different nodes in the cluster.

Activation Modes for Shared Disk Groups

Activation Mode	Description
<code>exclusive-write (ew)</code>	The node has exclusive write access to the disk group. No other node can activate the disk group for write access.
<code>read-only (ro)</code>	The node has read access to the disk group and denies write access for all other nodes in the cluster. The node has no write access to the disk group. Attempts to activate a disk group for either of the write modes on other nodes fail.
<code>shared-read (sr)</code>	The node has read access to the disk group. The node has no write access to the disk group, however other nodes can obtain write access.
<code>shared-write (sw)</code>	The node has write access to the disk group.
<code>off</code>	The node has neither read nor write access to the disk group. Query operations on the disk group are permitted.



The following table summarizes the allowed and conflicting activation modes for shared disk groups:

Allowed and Conflicting Activation Modes

Disk group activated in cluster as...	Attempt to activate disk group on another node as...			
	exclusive-write	read-only	shared-read	shared-write
exclusive-write	Fails	Fails	Succeeds	Fails
read-only	Fails	Succeeds	Succeeds	Fails
shared-read	Succeeds	Succeeds	Succeeds	Succeeds
shared-write	Fails	Fails	Succeeds	Succeeds

Shared disk groups can be automatically activated in any mode during disk group creation or during manual or auto-import. To control auto-activation of shared disk groups, the defaults file `/etc/default/vxdg` must be created.

The defaults file `/etc/default/vxdg` must contain the following lines:

```
enable_activation=true
default_activation_mode=activation-mode
```

The *activation-mode* is one of `exclusive-write`, `read-only`, `shared-read`, `shared-write`, or `off`.

When a shared disk group is created or imported, it is activated in the specified mode. When a node joins the cluster, all shared disk groups accessible from the node are activated in the specified mode.

Note The activation mode of a disk group controls volume I/O from different nodes in the cluster. It is not possible to activate a disk group on a given node if it is activated in a conflicting mode on another node in the cluster. When enabling activation using the defaults file, it is recommended that this file be made identical on all nodes in the cluster. Otherwise, the results of activation are unpredictable.

If the defaults file is edited while the `vxconfigd` daemon is already running, the `vxconfigd` process must be restarted for the changes in the defaults file to take effect.

If the default activation mode is anything other than `off`, an activation following a cluster join, or a disk group creation or import can fail if another node in the cluster has activated the disk group in a conflicting mode.

To display the activation mode for a shared disk group, use the `vxdg list diskgroup` command as described in “[Listing Shared Disk Groups](#)” on page 371.



You can also use the `vxchg` command to change the activation mode on a shared disk group as described in [“Changing the Activation Mode on a Shared Disk Group”](#) on page 375.

For a description of how to configure a volume so that it can only be opened by a single node in a cluster, see [“Creating Volumes with Exclusive Open Access by a Node”](#) on page 376 and [“Setting Exclusive Open Access to a Volume by a Node”](#) on page 377.

Connectivity Policy of Shared Disk Groups

A shared disk group provides concurrent read and write access to the volumes that it contains for all nodes in a cluster. A shared disk group can only be created on the master node. This has the following advantages and implications:

- ◆ All nodes in the cluster see exactly the same configuration.
- ◆ Only the master node can change the configuration.
- ◆ Any changes on the master node are automatically coordinated and propagated to the slave nodes in the cluster.
- ◆ Any failures that require a configuration change must be sent to the master node so that they can be resolved correctly.
- ◆ As the master node resolves failures, all the slave nodes are correctly updated. This ensures that all nodes have the same view of the configuration.

The practical implication of this design is that I/O failure on any node results in the configuration of all nodes being changed. This is known as the *global detach policy*. However, in some cases, it is not desirable to have all nodes react in this way to I/O failure. To address this, an alternate way of responding to I/O failures, known as the *local detach policy*, was introduced in release 3.2 of VxVM.

The local detach policy is intended for use with shared mirrored volumes in a cluster. This policy prevents I/O failure on a single slave node from causing a plex to be detached. This would require the plex to be resynchronized when it is subsequently reattached. The local detach policy is available for disk groups that have a version number of 70 or greater.

Note For small mirrored volumes, non-mirrored volumes, volumes that use hardware mirrors, and volumes in private disk groups, there is no benefit in configuring the local detach policy. In most cases, it is recommended that you use the default global detach policy.

The detach policies have no effect if the master node loses access to all copies of the configuration database and logs in a disk group. If this happened in releases prior to 4.1, the master node always disabled the disk group. Release 4.1 introduces the *disk group failure policy*, which allows you to change this behavior for critical disk groups. This policy is only available for disk groups that have a version number of 120 or greater.



The following sections describe the detach and failure policies in greater detail.

Global Detach Policy

Caution The global detach policy must be selected when Dynamic MultiPathing (DMP) is used to manage multipathing on Active/Passive arrays, This ensures that all nodes correctly coordinate their use of the active path.

The global detach policy is the traditional and default policy for all nodes on the configuration. If there is a read or write I/O failure on a slave node, the master node performs the usual I/O recovery operations to repair the failure, and the plex is detached cluster-wide. All nodes remain in the cluster and continue to perform I/O, but the redundancy of the mirrors is reduced. When the problem that caused the I/O failure has been corrected, the mirrors that were detached must be recovered before the redundancy of the data can be restored.

Local Detach Policy

Caution Do not use the local detach policy if you use the VCS agents that monitor the cluster functionality of VERITAS Volume Manager, and which are provided with VERITAS Storage Foundation™ for Cluster File System HA and VERITAS Storage Foundation for databases HA. These agents do not notify VCS about local failures.

The local detach policy is designed to support failover applications in large clusters where the redundancy of the volume is more important than the number of nodes that can access the volume. If there is a write failure on a slave node, the master node performs the usual I/O recovery operations to repair the failure, and additionally contacts all the nodes to see if the disk is still acceptable to them. If the write failure is not seen by all the nodes, I/O is stopped for the node that first saw the failure, and the application using the volume is also notified about the failure.

If required, configure the cluster management software to move the application to a different node, and/or remove the node that saw the failure from the cluster. The volume continues to return write errors, as long as one mirror of the volume has an error. The volume continues to satisfy read requests as long as one good plex is available.

If the reason for the I/O error is corrected and the node is still a member of the cluster, it can resume performing I/O from/to the volume without affecting the redundancy of the data.

See [“Setting the Disk Detach Policy on a Shared Disk Group”](#) on page 376 for information on how to use the `vxchg` command to set the disk detach policy on a shared disk group.

The table, “[Cluster Behavior Under I/O Failure to a Mirrored Volume for Different Disk Detach Policies](#),” summarizes the effect on a cluster of I/O failure to the disks in a mirrored volume:

Cluster Behavior Under I/O Failure to a Mirrored Volume for Different Disk Detach Policies

Type of I/O Failure	Local (diskdetpolicy=local)	Global (diskdetpolicy=global)
Failure of path to one disk in a volume for a single node	Reads fail only if no plexes remain available to the affected node. Writes to the volume fail.	The plex is detached, and I/O from/to the volume continues. An I/O error is generated if no plexes remain.
Failure of paths to all disks in a volume for a single node	I/O fails for the affected node.	The plex is detached, and I/O from/to the volume continues. An I/O error is generated if no plexes remain.
Failure of one or more disks in a volume for all nodes.	The plex is detached, and I/O from/to the volume continues. An I/O error is generated if no plexes remain.	The plex is detached, and I/O from/to the volume continues. An I/O error is generated if no plexes remain.

Disk Group Failure Policy

The local detach policy by itself is insufficient to determine the desired behavior if the master node loses access to all disks that contain copies of the configuration database and logs. In this case, the disk group is disabled. As a result, the other nodes in the cluster also lose access to the volume. In release 4.1, the disk group failure policy is introduced to determine the behavior of the master node in such cases. This policy has two possible settings as shown in the following table:

Behavior of Master Node for Different Failure Policies

Type of I/O Failure	Leave (dgfailpolicy=leave)	Disable (dgfailpolicy=dgdisable)
Master node loses access to all copies of the logs.	The master node panics with the message “klog update failed” for a failed kernel-initiated transaction, or “cvm config update failed” for a failed user-initiated transaction.	The master node disables the disk group.

The behavior of the master node under the disk group failure policy is independent of the setting of the disk detach policy. If the disk group failure policy is set to `leave`, all nodes panic in the unlikely case that none of them can access the log copies.



See “[Setting the Disk Group Failure Policy on a Shared Disk Group](#)” on page 376 for information on how to use the `vxchg` command to set the failure policy on a shared disk group.

Guidelines for Choosing Detach and Failure Policies

In most cases it is recommended that you use the global detach policy, and particularly if any of the following conditions apply:

- ◆ If you are using the VCS agents that monitor the cluster functionality of VERITAS Volume Manager, and which are provided with VERITAS Storage Foundation™ for Cluster File System HA and VERITAS Storage Foundation for databases HA. These agents do not notify VCS about local failures.
- ◆ When an array is seen by DMP as Active/Passive. The local detach policy causes unpredictable behavior for Active/Passive arrays.
- ◆ For clusters with four or fewer nodes. With a small number of nodes in a cluster, it is preferable to keep all nodes actively using the volumes, and to keep the applications running on all the nodes.
- ◆ If only non-mirrored, small mirrored, or hardware mirrored volumes are configured. This avoids the system overhead of the extra messaging that is required by the local detach policy.

The local detach policy may be suitable in the following cases:

- ◆ When large mirrored volumes are configured. Resynchronizing a reattached plex can degrade system performance. The local detach policy can avoid the need to detach the plex at all. (Alternatively, the dirty region logging (DRL) feature can be used to reduce the amount of resynchronization that is required.)
- ◆ For clusters with more than four nodes. Keeping an application running on a particular node is less critical when there are many nodes in a cluster. It may be possible to configure the cluster management software to move an application to a node that has access to the volumes. In addition, load balancing may be able to move applications to a different volume from the one that experienced the I/O problem. This preserves data redundancy, and other nodes may still be able to perform I/O from/to the volumes on the disk.

If you have a critical disk group that you do not want to become disabled in the case that the master node loses access to the copies of the logs, set the disk group failure policy to `leave`. This prevents I/O failure on the master node disabling the disk group. However, critical applications running on the master node fail if they lose access to the other shared disk groups. In such a case, it may be preferable to set the policy to `dgdisable`, and to allow the disk group to be disabled.

The default settings for the detach and failure policies are `global` and `dgdisable` respectively. You can use the `vxvg` command to change both the detach and failure policies on a shared disk group, as shown in this example:

```
# vxvg -g diskgroup set diskdetpolicy=local dgfailpolicy=leave
```

Effect of Disk Connectivity on Cluster Reconfiguration

The detach policy, previous I/O errors, or access to disks are not considered when a new master node is chosen. When the master node leaves a cluster, the node that takes over as master of the cluster may already have seen I/O failures for one or more disks. Under the local detach policy, only one node was affected before reconfiguration, but when the node becomes the master, the failure is treated as described in [“Effect of Disk Connectivity on Cluster Reconfiguration.”](#)

The detach policy does not change the requirement that a node joining a cluster must have access to all the disks in all shared disk groups. Similarly, a node that is removed from the cluster because of an I/O failure cannot rejoin the cluster until this requirement is met.

Limitations of Shared Disk Groups

Note The boot disk group (usually aliased as `bootdg`) cannot be made cluster-shareable. It must be private.

Only raw device access may be performed via the cluster functionality of VxVM. It does not support shared access to file systems in shared volumes unless the appropriate software is installed and configured.

The cluster functionality of VxVM does not support RAID-5 volumes, or task monitoring for cluster-shareable disk groups. These features can, however, be used in private disk groups that are attached to specific nodes of a cluster.

If you have RAID-5 volumes in a private disk group that you wish to make shareable, you must first relayout the volumes as a supported volume type such as `stripe-mirror` or `mirror-stripe`. Online relayout of shared volumes is supported provided that it does not involve RAID-5 volumes.

If a shared disk group contains RAID-5 volumes, deport it and then reimport the disk group as private on one of the cluster nodes. Reorganize the volumes into layouts that are supported for shared disk groups, and then deport and reimport the disk group as shared.



Cluster Initialization and Configuration

Before any nodes can join a new cluster for the first time, you must supply certain configuration information during cluster monitor setup. This information is normally stored in some form of cluster monitor configuration database. The precise content and format of this information depends on the characteristics of the cluster monitor. The information required by VxVM is as follows:

- ◆ cluster ID
- ◆ node IDs
- ◆ network addresses of nodes
- ◆ port addresses

When a node joins the cluster, this information is automatically loaded into VxVM on that node at node startup time.

Note To make effective use of the cluster functionality of VxVM requires that you configure a cluster monitor (such as provided by GAB (Group Membership and Atomic Broadcast) in VCS).

The cluster monitor startup procedure effects node initialization, and brings up the various cluster components (such as VxVM with cluster support, the cluster monitor, and a distributed lock manager) on the node. Once this is complete, applications may be started. The cluster monitor startup procedure must be invoked on each node to be joined to the cluster.

For VxVM in a cluster environment, initialization consists of loading the cluster configuration information and joining the nodes in the cluster. The first node to join becomes the master node, and later nodes (slaves) join to the master. If two nodes join simultaneously, VxVM chooses the master. Once the join for a given node is complete, that node has access to the shared disk groups and volumes.

Cluster Reconfiguration

Cluster reconfiguration occurs if a node leaves or joins a cluster. Each node's cluster monitor continuously watches the other cluster nodes. When the membership of the cluster changes, the cluster monitor informs VxVM for it to take appropriate action.

During cluster reconfiguration, VxVM suspends I/O to shared disks. I/O resumes when the reconfiguration completes. Applications may appear to freeze for a short time during reconfiguration.

If other operations, such as VxVM operations or recoveries, are in progress, cluster reconfiguration can be delayed until those operations have completed. Volume reconfigurations (see "[Volume Reconfiguration](#)" on page 361) do not take place at the

same time as cluster reconfigurations. Depending on the circumstances, an operation may be held up and restarted later. In most cases, cluster reconfiguration takes precedence. However, if the volume reconfiguration is in the commit stage, it completes first.

For more information on cluster reconfiguration, see “[vxclustadm Utility](#)” on page 359.

vxclustadm Utility

The `vxclustadm` command provides an interface to the cluster functionality of VxVM when VCS is used as the cluster monitor. It is also called during cluster startup and shutdown. In the absence of a cluster monitor, `vxclustadm` can also be used to activate or deactivate the cluster functionality of VxVM on any node in a cluster.

The `startnode` keyword to `vxclustadm` starts cluster functionality on a cluster node by passing cluster configuration information to the VxVM kernel. In response to this command, the kernel and the VxVM configuration daemon, `vxconfigd`, perform initialization.

The `stopnode` keyword stops cluster functionality on a node. It waits for all outstanding I/O to complete and for all applications to close shared volumes.

The `abortnode` keyword terminates cluster activity on a node. It does not wait for outstanding I/O to complete nor for applications to close shared volumes.

The `reinit` keyword allows nodes to be added to or removed from a cluster without stopping the cluster. Before running this command, the cluster configuration configuration file must have been updated with information about the supported nodes in the cluster.

The `nidmap` keyword prints a table showing the mapping between node IDs in VxVM’s cluster-support subsystem and node IDs in the cluster monitor. It also prints the state of the node in the cluster.

The `nodestate` keyword reports the state of a cluster node and also the reason for the last abort of the node as shown in this example:

```
# /etc/vx/bin/vxclustadm nodestate
state: out of cluster
reason: user initiated stop
```

The various reasons that may be given are shown in the following table:

Reason	Description
cannot find disk on slave node	Missing disk or bad disk on the slave node.
cannot obtain configuration data	The node cannot read the configuration data due to an error such as disk failure.



Reason	Description
<code>cluster device open failed</code>	Open of a cluster device failed.
<code>clustering license mismatch with master node</code>	Clustering license does not match that on the master node.
<code>clustering license not available</code>	Clustering license cannot be found.
<code>connection refused by master</code>	Join of a node refused by the master node.
<code>disk in use by another cluster</code>	A disk belongs to a cluster other than the one that a node is joining.
<code>join timed out during reconfiguration</code>	Join of a node has timed out due to reconfiguration taking place in the cluster.
<code>klog update failed</code>	Cannot update kernel log copies during the join of a node.
<code>master aborted during join</code>	Master node aborted while another node was joining the cluster.
<code>minor number conflict</code>	Minor number conflicts exist between private disk groups and shared disk groups that are being imported.
<code>protocol version out of range</code>	Cluster protocol version mismatch or unsupported version.
<code>recovery in progress</code>	Volumes that were opened by the node are still recovering.
<code>transition to role failed</code>	Changing the role of a node to be the master failed.
<code>user initiated abort</code>	Node is out of cluster due to an abort initiated by the cluster monitor.
<code>user initiated stop</code>	Node is out of cluster due to a stop initiated by the user or by the cluster monitor.
<code>vxconfigd is not enabled</code>	The VxVM configuration daemon is not enabled.

See the `vxclustadm(1M)` manual page for more information about `vxclustadm` and for examples of its usage.



Volume Reconfiguration

Volume reconfiguration is the process of creating, changing, and removing VxVM objects such as disk groups, volumes and plexes. In a cluster, all nodes co-operate to perform such operations. The `vxconfigd` daemons (see “[vxconfig Daemon](#)” on page 362) play an active role in volume reconfiguration. For reconfiguration to succeed, a `vxconfigd` daemon must be running on each of the nodes.

A volume reconfiguration *transaction* is initiated by running a VxVM utility on the master node. The utility contacts the local `vxconfigd` daemon on the master node, which validates the requested change. For example, `vxconfigd` rejects an attempt to create a new disk group with the same name as an existing disk group. The `vxconfigd` daemon on the master node then sends details of the changes to the `vxconfigd` daemons on the slave nodes. The `vxconfigd` daemons on the slave nodes then perform their own checking. For example, each slave node checks that it does not have a private disk group with the same name as the one being created; if the operation involves a new disk, each node checks that it can access that disk. When the `vxconfigd` daemons on all the nodes agree that the proposed change is reasonable, each notifies its kernel. The kernels then co-operate to either commit or to abandon the transaction. Before the transaction can be committed, all of the kernels ensure that no I/O is underway. The master node is responsible both for initiating the reconfiguration, and for coordinating the commitment of the transaction. The resulting configuration changes appear to occur simultaneously on all nodes.

If a `vxconfigd` daemon on any node goes away during reconfiguration, all nodes are notified and the operation fails. If any node leaves the cluster, the operation fails unless the master has already committed it. If the master node leaves the cluster, the new master node, which was previously a slave node, completes or fails the operation depending on whether or not it received notification of successful completion from the previous master node. This notification is performed in such a way that if the new master does not receive it, neither does any other slave.

If a node attempts to join a cluster while a volume reconfiguration is being performed, the result of the reconfiguration depends on how far it has progressed. If the kernel has not yet been invoked, the volume reconfiguration is suspended until the node has joined the cluster. If the kernel has been invoked, the node waits until the reconfiguration is complete before joining the cluster.

When an error occurs, such as when a check on a slave fails or a node leaves the cluster, the error is returned to the utility and a message is sent to the console on the master node to identify on which node the error occurred.



vxconfigd Daemon

The VxVM configuration daemon, `vxconfigd`, maintains the configuration of VxVM objects. It receives cluster-related instructions from the kernel. A separate copy of `vxconfigd` runs on each node, and these copies communicate with each other over a network. When invoked, a VxVM utility communicates with the `vxconfigd` daemon running on the same node; it does not attempt to connect with `vxconfigd` daemons on other nodes. During cluster startup, the kernel prompts `vxconfigd` to begin cluster operation and indicates whether it is a master node or a slave node.

When a node is initialized for cluster operation, the `vxconfigd` daemon is notified that the node is about to join the cluster and is provided with the following information from the cluster monitor configuration database:

- ◆ cluster ID
- ◆ node IDs
- ◆ master node ID
- ◆ role of the node
- ◆ network address of the `vxconfigd` daemon on each node (if applicable)

On the master node, the `vxconfigd` daemon sets up the shared configuration by importing shared disk groups, and informs the kernel when it is ready for the slave nodes to join the cluster.

On slave nodes, the `vxconfigd` daemon is notified when the slave node can join the cluster. When the slave node joins the cluster, the `vxconfigd` daemon and the VxVM kernel communicate with their counterparts on the master node to set up the shared configuration.

When a node leaves the cluster, the kernel notifies the `vxconfigd` daemon on all the other nodes. The master node then performs any necessary cleanup. If the master node leaves the cluster, the kernels select a new master node and the `vxconfigd` daemons on all nodes are notified of the choice.

The `vxconfigd` daemon also participates in volume reconfiguration as described in [“Volume Reconfiguration”](#) on page 361.

vxconfigd Daemon Recovery

In a cluster, the `vxconfigd` daemons on the slave nodes are always connected to the `vxconfigd` daemon on the master node. If the `vxconfigd` daemon is stopped, volume reconfiguration cannot take place. Other nodes can join the cluster if the `vxconfigd` daemon is not running on the slave nodes.

If the `vxconfigd` daemon stops, different actions are taken depending on which node this occurred:

- ◆ If the `vxconfigd` daemon is stopped on the master node, the `vxconfigd` daemons on the slave nodes periodically attempt to rejoin to the master node. Such attempts do not succeed until the `vxconfigd` daemon is restarted on the master. In this case, the `vxconfigd` daemons on the slave nodes have not lost information about the shared configuration, so that any displayed configuration information is correct.
- ◆ If the `vxconfigd` daemon is stopped on a slave node, the master node takes no action. When the `vxconfigd` daemon is restarted on the slave, the slave `vxconfigd` daemon attempts to reconnect to the master daemon and to re-acquire the information about the shared configuration. (Neither the kernel view of the shared configuration nor access to shared disks is affected.) Until the `vxconfigd` daemon on the slave node has successfully reconnected to the `vxconfigd` daemon on the master node, it has very little information about the shared configuration and any attempts to display or modify the shared configuration can fail. For example, shared disk groups listed using the `vx dg list` command are marked as `disabled`; when the rejoin completes successfully, they are marked as `enabled`.
- ◆ If the `vxconfigd` daemon is stopped on both the master and slave nodes, the slave nodes do not display accurate configuration information until `vxconfigd` is restarted on the master and slave nodes, and the daemons have reconnected.

If the CVM agent for VCS determines that the `vxconfigd` daemon is not running on a node during a cluster reconfiguration, `vxconfigd` is restarted automatically.

If it is necessary to restart `vxconfigd` manually in a VCS controlled cluster to resolve a VxVM issue, use this procedure:

1. Use the following command to disable failover on any service groups that contain VxVM objects:

```
# hagrps -freeze group
```
2. Enter the following command to stop and restart the VxVM configuration daemon on the affected node:

```
# vxconfigd -k
```
3. Use the following command to re-enable failover for the service groups that you froze in step 1:

```
# hagrps -unfreeze group
```

Note The `-r` reset option to `vxconfigd` restarts the `vxconfigd` daemon and recreates all states from scratch. This option cannot be used to restart `vxconfigd` while a node is joined to a cluster because it causes cluster information to be discarded.



Node Shutdown

Although it is possible to shut down the cluster on a node by invoking the shutdown procedure of the node's cluster monitor, this procedure is intended for terminating cluster components after stopping any applications on the node that have access to shared storage. VxVM supports *clean node shutdown*, which allows a node to leave the cluster gracefully when all access to shared volumes has ceased. The host is still operational, but cluster applications cannot be run on it.

The cluster functionality of VxVM maintains global state information for each volume. This enables VxVM to determine which volumes need to be recovered when a node crashes. When a node leaves the cluster due to a crash or by some other means that is not clean, VxVM determines which volumes may have writes that have not completed and the master node resynchronizes these volumes. It can use dirty region logging (DRL) or FastResync if these are active for any of the volumes.

Clean node shutdown must be used after, or in conjunction with, a procedure to halt all cluster applications. Depending on the characteristics of the clustered application and its shutdown procedure, a successful shutdown can require a lot of time (minutes to hours). For instance, many applications have the concept of *draining*, where they accept no new work, but complete any work in progress before exiting. This process can take a long time if, for example, a long-running transaction is active.

When the VxVM shutdown procedure is invoked, it checks all volumes in all shared disk groups on the node that is being shut down. The procedure then either continues with the shutdown, or fails for one of the following reasons:

- ◆ If all volumes in shared disk groups are closed, VxVM makes them unavailable to applications. Because all nodes are informed that these volumes are closed on the leaving node, no resynchronization is performed.
- ◆ If any volume in a shared disk group is open, the shutdown operation in the kernel waits until the volume is closed. There is no timeout checking in this operation.

Note Once shutdown succeeds, the node has left the cluster. It is not possible to access the shared volumes until the node joins the cluster again.

Since shutdown can be a lengthy process, other reconfiguration can take place while shutdown is in progress. Normally, the shutdown attempt is suspended until the other reconfiguration completes. However, if it is already too far advanced, the shutdown may complete first.

Node Abort

If a node does not leave a cluster cleanly, this is because it crashed or because some cluster component made the node leave on an emergency basis. The ensuing cluster reconfiguration calls the VxVM abort function. This procedure immediately attempts to halt all access to shared volumes, although it does wait until pending I/O from or to the disk completes.

I/O operations that have not yet been started are failed, and the shared volumes are removed. Applications that were accessing the shared volumes therefore fail with errors.

After a node abort or crash, shared volumes must be recovered, either by a surviving node or by a subsequent cluster restart, because it is very likely that there are unsynchronized mirrors.

Cluster Shutdown

If all nodes leave a cluster, shared volumes must be recovered when the cluster is next started if the last node did not leave cleanly, or if resynchronization from previous nodes leaving uncleanly is incomplete.

Upgrading Cluster Functionality

The rolling upgrade feature allows you to upgrade the version of VxVM running in a cluster without shutting down the entire cluster. To install the new version of VxVM running on a cluster, make one node leave the cluster, upgrade it, and then join it back into the cluster. This operation is repeated for each node in the cluster.

Note Rolling upgrade is supported for the cluster functionality of VxVM, but may not be supported for other software components (such as CFS) if these have been installed. Consult the release notes that accompany that product for more information.

Each VERITAS Volume Manager release starting with Release 3.1 has a *cluster protocol version number* associated with it. The cluster protocol version is not the same as the release number or the disk group version number. The cluster protocol version is stored in the `/etc/vx/volboot` file. During a new installation of VxVM, the `vxctl init` command creates the `volboot` file and sets the cluster protocol version to the highest supported version.

Each new VERITAS Volume Manager release supports two cluster protocol versions. The lower version number corresponds to a previous VERITAS Volume Manager release. This has a fixed set of features and communication protocols. The higher version number corresponds to the new release of VxVM which has a new set of these features. If the new



release of VxVM does not have any functional or protocol changes, but only bug fixes or minor changes, the cluster protocol version remains unchanged. In this case, the cluster protocol version does not need to be upgraded.

During a rolling upgrade, each node must be shut down and the VERITAS Volume Manager release with the latest cluster protocol version must be installed. All nodes that have the new release of VxVM continue to use the lower level version. A slave node that has the new cluster protocol version installed tries to join the cluster. If the new cluster protocol version is not in use on the master node, it rejects the join and provides the current cluster protocol version to the slave node. The slave retries the join with the cluster protocol version provided by the master node. If the join fails at this point, the cluster protocol version on the master node is out of range of the protocol versions supported by the joining slave. In such a situation, you must upgrade the remainder of the cluster through each intermediate release of VxVM to reach the latest supported cluster protocol version.

Once you have installed the new release on all nodes, run the `vxctl upgrade` command on the master node to switch the cluster to the higher cluster protocol version. See [“Upgrading the Cluster Protocol Version”](#) on page 378 for more information.

Dirty Region Logging (DRL) in Cluster Environments

Dirty region logging (DRL) is an optional property of a volume that provides speedy recovery of mirrored volumes after a system failure. DRL is supported in cluster-shareable disk groups. This section provides a brief overview of how DRL behaves in a cluster environment. For more information on DRL, see [“Dirty Region Logging \(DRL\)”](#) on page 42.

In a cluster environment, the VxVM implementation of DRL differs slightly from the normal implementation.

A dirty region log on a system without cluster support has a recovery map and a single active map. A dirty region log in a cluster, however, has one recovery map and one active map for each node in the cluster.

The dirty region log size in clusters is typically larger than in non-clustered systems, as it must accommodate a recovery map plus active maps for each node in the cluster. The size of each map within the dirty region log is one or more whole blocks. The `vxassist` command automatically allocates a sufficiently large dirty region log for the size of the volume and the number of nodes.

It is possible to reimport a non-shared disk group (and its volumes) as a shared disk group in a cluster environment. However, the dirty region logs of the imported disk group may be considered invalid and a full recovery may result.

If a shared disk group is imported as a private disk group on a system without cluster support, VxVM considers the logs of the shared volumes to be invalid and conducts a full volume recovery. After the recovery completes, VxVM uses DRL.

The cluster functionality of VxVM can perform a DRL recovery on a non-shared volume. However, if such a volume is moved to a VxVM system with cluster support and imported as shared, the dirty region log is probably too small to accommodate maps for all the cluster nodes. VxVM then marks the log invalid and performs a full recovery anyway. Similarly, moving a DRL volume from a two-node cluster to a four-node cluster can result in too small a log size, which the cluster functionality of VxVM handles with a full volume recovery. In both cases, you must allocate a new log of sufficient size.

How DRL Works in a Cluster Environment

When one or more nodes in a cluster crash, DRL must handle the recovery of all volumes that were in use by those nodes when the crashes occurred. On initial cluster startup, all active maps are incorporated into the recovery map during the volume start operation.

Nodes that crash (that is, leave the cluster as *dirty*) are not allowed to rejoin the cluster until their DRL active maps have been incorporated into the recovery maps on all affected volumes. The recovery utilities compare a crashed node's active maps with the recovery map and make any necessary updates before the node can rejoin the cluster and resume I/O to the volume (which overwrites the active map). During this time, other nodes can continue to perform I/O.

VxVM tracks which nodes have crashed. If multiple node recoveries are underway in a cluster at a given time, their respective recoveries and recovery map updates can compete with each other. VxVM tracks changes in the state of DRL recovery and prevents I/O collisions.

The master node performs volatile tracking of DRL recovery map updates for each volume, and prevents multiple utilities from changing the recovery map simultaneously.

Multi-Host Failover Configurations

Outside the context of clustering functionality, VxVM disk groups can be “imported” (made available) from only one host at any given time. When a host imports a disk group as private, the volumes and configuration of that disk group become accessible to the host. If the administrator or system software wants to privately use the same disk group from another host, the host that already has the disk group imported (*importing host*) must “deport” (give up access to) the disk group. Once deported, the disk group can be imported by another host.



If two hosts are allowed to access a disk group concurrently without proper synchronization, such as that provided by the Oracle Parallel Server, the configuration of the disk group, and possibly the contents of volumes, can be corrupted. Similar corruption can also occur if a file system or database on a raw disk partition is accessed concurrently by two hosts, so this problem is not limited to VERITAS Volume Manager.

Import Lock

When a host in a non-clustered environment imports a disk group, an import lock is written on all disks in that disk group. The import lock is cleared when the host deports the disk group. The presence of the import lock prevents other hosts from importing the disk group until the importing host has deported the disk group.

Specifically, when a host imports a disk group, the import normally fails if any disks within the disk group appear to be locked by another host. This allows automatic re-importing of disk groups after a reboot (*autoimporting*) and prevents imports by another host, even while the first host is shut down. If the importing host is shut down without deporting the disk group, the disk group can only be imported by another host by clearing the host ID lock first (discussed later).

The import lock contains a host ID (in VERITAS Volume Manager, this is the host name) reference to identify the importing host and enforce the lock. Problems can therefore arise if two hosts have the same host ID.

Note Since VERITAS Volume Manager uses the host name as the host ID (by default), it is advisable to change the host name of one machine if another machine shares its host name. To change the host name, use the `vxctl hostid new_hostname` command.

Failover

The import locking scheme works well in an environment where disk groups are not normally shifted from one system to another. However, consider a setup where two hosts, Node A and Node B, can access the drives of a disk group. The disk group is first imported by Node A, but the administrator wants to access the disk group from Node B if Node A crashes. This kind of scenario (*failover*) can be used to provide manual high availability to data, where the failure of one node does not prevent access to data. Failover can be combined with a “high availability” monitor to provide automatic high availability to data: when Node B detects that Node A has crashed or shut down, Node B imports (fails over) the disk group to provide access to the volumes.

VERITAS Volume Manager can support failover, but it relies on the administrator or on an external high-availability monitor to ensure that the first system is shut down or unavailable before the disk group is imported to another system. For details on how to clear locks and force an import, see “[Moving Disk Groups Between Systems](#)” on page 144 and the `vxdbg(1M)` manual page.

Corruption of Disk Group Configuration

If `vxdbg import` is used with `-C` (clears locks) and/or `-f` (forces import) to import a disk group that is still in use from another host, disk group configuration corruption is likely to occur. Volume content corruption is also likely if a file system or database is started on the imported volumes before the other host crashes or shuts down.

If this kind of corruption occurs, you must probably rebuild your configuration from scratch and reload all volumes in the disk group from a backup. To backup and rebuild the configuration, if nothing has changed, use `vxprint -mispvd` and store the output which can be fed to `vxmlake` to restore the layouts. There are typically numerous configuration copies for each disk group, but corruption nearly always affects all configuration copies, so redundancy does not help in this case.

Disk group configuration corruption usually shows up as missing or duplicate records in the configuration databases. This can result in a variety of `vxconfigd` error messages

```
VxVM vxconfigd ERROR V-5-1-569 Disk group group, Disk disk: Cannot
auto-import group: reason
```

where the *reason* can describe errors such as:

```
Association not resolved
Association count is incorrect
Duplicate record in configuration
Configuration records are inconsistent
```

These errors are typically reported in association with specific disk group configuration copies, but usually apply to all copies. The following is usually displayed along with the error:

```
Disk group has no valid configuration copies
```

See the *VERITAS Volume Manager Troubleshooting Guide* for more information on VERITAS Volume Manager error messages.

If you use the VERITAS Cluster Server product, all disk group failover issues can be managed correctly. VCS includes a high availability monitor and includes failover scripts for VxVM, VxFS, and for several popular databases.

The `-t` option to `vxdbg` prevents automatic re-imports on reboot and is necessary when used with a host monitor (such as VCS) that controls imports itself, rather than relying on automatic imports by VERITAS Volume Manager.



Administering VxVM in Cluster Environments

The following sections describe the administration of VxVM's cluster functionality.

Note Most VxVM commands require superuser or equivalent privileges.

Requesting Node Status and Discovering the Master Node

The `vxctl` utility controls the operation of the `vxconfigd` volume configuration daemon. The `-c` option can be used to request cluster information and to find out which node is the master. To determine whether the `vxconfigd` daemon is enabled and/or running, use the following command:

```
# vxctl -c mode
```

This produces different output messages depending on the current status of the cluster node:

Status Message	Description
mode: enabled: cluster active - MASTER master: mozart	The node is the master.
mode: enabled: cluster active - SLAVE master: mozart	The node is a slave.
mode: enabled: cluster active - role not set master: mozart state: joining reconfig: master update	The node has not yet been assigned a role, and is in the process of joining the cluster.
mode: enabled: cluster active - SLAVE master: mozart state: joining	The node is configured as a slave, and is in the process of joining the cluster.
mode: enabled: cluster inactive	The cluster is not active.

Note If the `vxconfigd` daemon is disabled, no cluster information is displayed.

See the `vxctl(1M)` manual page for more information.

Determining if a Disk is Shareable

The `vxdisk` utility manages VxVM disks. To use the `vxdisk` utility to determine whether a disk is part of a cluster-shareable disk group, use the following command:

```
# vxdisk list accessname
```

where *accessname* is the disk access name (or device name). A portion of the output from this command (for the device `c4t1d0`) is shown here:

```
Device:      c4t1d0
devicetag:   c4t1d0
type:        auto
clusterid:   cvm2
disk:        name=shdg01 id=963616090.1034.cvm2
timeout:     30
group:       name=shdg id=963616065.1032.cvm2
flags:       online ready autoconfig shared imported
...
```

Note that the `clusterid` field is set to `cvm2` (the name of the cluster), and the `flags` field includes an entry for `shared`. When a node is not joined to the cluster, the `flags` field contains the `autoimport` flag instead of `imported`.

Listing Shared Disk Groups

`vxldg` can be used to list information about shared disk groups. To display information for all disk groups, use the following command:

```
# vxldg list
```

Example output from this command is displayed here:

NAME	STATE	ID
rootdg	enabled	774215886.1025.teal
group2	enabled, shared	774575420.1170.teal
group1	enabled, shared	774222028.1090.teal

Shared disk groups are designated with the flag `shared`.

To display information for shared disk groups only, use the following command:

```
# vxldg -s list
```

Example output from this command is as follows:

NAME	STATE	ID
group2	enabled, shared	774575420.1170.teal
group1	enabled, shared	774222028.1090.teal



To display information about one specific disk group, use the following command:

```
# vxdg list diskgroup
```

The following is example output for the command `vx dg list group1` on the master:

```
Group:      group1
dgid:      774222028.1090.teal
import-id: 32768.1749
flags:     shared
version:   120
alignment: 8192 (bytes)
ssb:      on
local-activation: exclusive-write
cluster-actv-modes: node0=ew node1=off
detach-policy: local
private_region_failure: leave
copies:    nconfig=2 nlog=2
config:    seqno=0.1976 permlen=1456 free=1448 templen=6 loglen=220
config disk c1t0d0 copy 1 len=1456 state=clean online
config disk c1t0d0 copy 1 len=1456 state=clean online
log disk c1t0d0 copy 1 len=220
log disk c1t0d0 copy 1 len=220
```

Note that the `flags` field is set to `shared`. The output for the same command when run on a slave is slightly different. The `local-activation` and `cluster-actv-modes` fields display the activation mode for this node and for each node in the cluster respectively. The `detach-policy` and `private_region_failure` fields indicate how the cluster behaves in the event of loss of connectivity to the disks, and to the configuration and log copies on the disks.

Creating a Shared Disk Group

Note Shared disk groups can only be created on the master node.

If the cluster software has been run to set up the cluster, a shared disk group can be created using the following command:

```
# vx dg -s init diskgroup [diskname=]devicename
```

where *diskgroup* is the disk group name, *diskname* is the administrative name chosen for a VM disk, and *devicename* is the device name (or disk access name).

Caution The operating system cannot tell if a disk is shared. To protect data integrity when dealing with disks that can be accessed by multiple systems, use the correct designation when adding a disk to a disk group. VxVM allows you to add a disk that is not physically shared to a shared disk group if the node where

the disk is accessible is the only node in the cluster. However, this means that other nodes cannot join the cluster. Furthermore, if you attempt to add the same disk to different disk groups (private or shared) on two nodes at the same time, the results are undefined. Perform all configuration on one node only, and preferably on the master node.

Forcibly Adding a Disk to a Disk Group

Note Disks can only be forcibly added to a shared disk group on the master node.

If VxVM does not add a disk to an existing disk group because that disk is not attached to the same nodes as the other disks in the disk group, you can forcibly add the disk using the following command:

```
# vxdbg -f adddisk -g diskgroup [diskname=]devicename
```

Caution Only use the force option(-f) if you are fully aware of the consequences such as possible data corruption.

Importing Disk Groups as Shared

Note Shared disk groups can only be imported on the master node.

Disk groups can be imported as shared using the `vxdbg -s import` command. If the disk groups are set up before the cluster software is run, the disk groups can be imported into the cluster arrangement using the following command:

```
# vxdbg -s import diskgroup
```

where *diskgroup* is the disk group name or ID. On subsequent cluster restarts, the disk group is automatically imported as shared. Note that it can be necessary to deport the disk group (using the `vxdbg deport diskgroup` command) before invoking the `vxdbg` utility.

Forcibly Importing a Disk Group

You can use the -f option to the `vxdbg` command to import a disk group forcibly.

Caution The force option(-f) must be used with caution and only if you are fully aware of the consequences such as possible data corruption.



When a cluster is restarted, VxVM can refuse to auto-import a disk group for one of the following reasons:

- ◆ A disk in the disk group is no longer accessible because of hardware errors on the disk. In this case, use the following command to forcibly reimport the disk group:

```
# vxvg -s -f import diskgroup
```
- ◆ Some of the nodes to which disks in the disk group are attached are not currently in the cluster, so the disk group cannot access all of its disks. In this case, a forced import is unsafe and must not be attempted because it can result in inconsistent mirrors.

Converting a Disk Group from Shared to Private

Note Shared disk groups can only be deported on the master node.

To convert a shared disk group to a private disk group, first deport it on the master node using this command:

```
# vxvg deport diskgroup
```

Then reimport the disk group on any cluster node using this command:

```
# vxvg import diskgroup
```

Moving Objects Between Disk Groups

As described in “[Moving Objects Between Disk Groups](#)” on page 163, you can use the `vxvg move` command to move a self-contained set of VxVM objects such as disks and top-level volumes between disk groups. In a cluster, you can move such objects between private disk groups on any cluster node where those disk groups are imported.

Note You can only move objects between shared disk groups on the master node. You cannot move objects between private and shared disk groups.

Splitting Disk Groups

As described in “[Splitting Disk Groups](#)” on page 165, you can use the `vxchg split` command to remove a self-contained set of VxVM objects from an imported disk group, and move them to a newly created disk group.

Splitting a private disk group creates a private disk group, and splitting a shared disk group creates a shared disk group. You can split a private disk group on any cluster node where that disk group is imported. You can only split a shared disk group or create a shared target disk group on the master node.

For a description of the other options, see “[Moving Objects Between Disk Groups](#)” on page 163.

Joining Disk Groups

As described in “[Joining Disk Groups](#)” on page 166, you can use the `vxchg join` command to merge the contents of two imported disk groups. In a cluster, you can join two private disk groups on any cluster node where those disk groups are imported.

If the source disk group and the target disk group are both shared, you must perform the join on the master node.

Note You cannot join a private disk group and a shared disk group.

Changing the Activation Mode on a Shared Disk Group

Note The activation mode for access by a cluster node to a shared disk group is set on that node.

The activation mode of a shared disk group can be changed using the following command:

```
# vxchg -g diskgroup set activation=mode
```

The activation *mode* is one of `exclusive-write` or `ew`, `read-only` or `ro`, `shared-read` or `sr`, `shared-write` or `sw`, or `off`. See “[Activation Modes of Shared Disk Groups](#)” on page 351 for more information.



Setting the Disk Detach Policy on a Shared Disk Group

Note The disk detach policy for a shared disk group can only be set on the master node.

The `vxdbg` command may be used to set either the `global` or `local` disk detach policy for a shared disk group:

```
# vxdbg -g diskgroup set diskdetpolicy=global|local
```

The default disk detach policy is `global`. See “[Connectivity Policy of Shared Disk Groups](#)” on page 353 for more information.

Setting the Disk Group Failure Policy on a Shared Disk Group

Note The disk group failure policy for a shared disk group can only be set on the master node.

The `vxdbg` command may be used to set either the `dgdisable` or `leave` failure policy for a shared disk group:

```
# vxdbg -g diskgroup set dgfailurepolicy=dgdisable|leave
```

The default failure policy is `dgdisable`. See “[Disk Group Failure Policy](#)” on page 355 for more information.

Creating Volumes with Exclusive Open Access by a Node

Note All shared volumes, including those with exclusive open access, can only be created on the master node.

When using the `vxassist` command to create a volume, you can use the `exclusive=on` attribute to specify that the volume may only be opened by one node in the cluster at a time. For example, to create the mirrored volume `volmir` in the disk group `dskgrp`, and configure it for exclusive open, use the following command:

```
# vxassist -g dskgrp make volmir 5g layout=mirror exclusive=on
```

Multiple opens by the same node are also supported. Any attempts by other nodes to open the volume fail until the final close of the volume by the node that opened it.

Specifying `exclusive=off` instead means that more than one node in a cluster can open a volume simultaneously.

Setting Exclusive Open Access to a Volume by a Node

Note Exclusive open access on a volume can only be set on the master node. Ensure that none of the nodes in the cluster have the volume open when setting this attribute.

You can set the `exclusive=on` attribute with the `vxvol` command to specify that an existing volume may only be opened by one node in the cluster at a time.

For example, to set exclusive open on the volume `volmir` in the disk group `dskgrp`, use the following command:

```
# vxvol -g dskgrp set exclusive=on volmir
```

Multiple opens by the same node are also supported. Any attempts by other nodes to open the volume fail until the final close of the volume by the node that opened it.

Specifying `exclusive=off` instead means that more than one node in a cluster can open a volume simultaneously.

Displaying the Cluster Protocol Version

The following command displays the cluster protocol version running on a node:

```
# vxdctl list
```

This command produces output similar to the following:

```
Volboot file
version: 3/1
seqno: 0.19
cluster protocol version: 60
hostid: giga
entries:
```

You can also check the existing cluster protocol version using the following command:

```
# vxdctl protocolversion
```

This produces output similar to the following:

```
Cluster running at protocol 60
```



Displaying the Supported Cluster Protocol Version Range

The following command displays the maximum and minimum protocol version supported by the node and the current protocol version:

```
# vxdctl support
```

This command produces out put similar to the following:

```
Support information:
vxconfigd_vrsn: 21
dg_minimum:    20
dg_maximum:    120
kernel:        15
protocol_minimum: 40
protocol_maximum: 60
protocol_current: 60
```

You can also use the following command to display the maximum and minimum cluster protocol version supported by the current VERITAS Volume Manager release:

```
# vxdctl protocolrange
```

This produces output similar to the following:

```
minprotoversion: 40, maxprotoversion: 60
```

Upgrading the Cluster Protocol Version

Note The cluster protocol version can only be updated on the master node.

After all the nodes in the cluster have been updated with a new cluster protocol, you can upgrade the entire cluster using the following command on the master node:

```
# vxdctl upgrade
```

Recovering Volumes in Shared Disk Groups

Note Volumes can only be recovered on the master node.

The `vxrecover` utility is used to recover plexes and volumes after disk replacement. When a node leaves a cluster, it can leave some mirrors in an inconsistent state. The `vxrecover` utility can be used to recover such volumes. The `-c` option to `vxrecover` causes it to recover all volumes in shared disk groups. The `vxconfigd` daemon automatically calls the `vxrecover` utility with the `-c` option when necessary.

Note While the `vxrecover` utility is active, there can be some degradation in system performance.

Obtaining Cluster Performance Statistics

The `vxstat` utility returns statistics for specified objects. In a cluster environment, `vxstat` gathers statistics from all of the nodes in the cluster. The statistics give the total usage, by all nodes, for the requested objects. If a local object is specified, its local usage is returned.

You can optionally specify a subset of nodes using the following form of the command:

```
# vxstat -g diskgroup -n node[,node...]
```

where *node* is an integer. If a comma-separated list of nodes is supplied, the `vxstat` utility displays the sum of the statistics for the nodes in the list.

For example, to obtain statistics for node 2, volume `vol1`, use the following command:

```
# vxstat -g group1 -n 2 vol1
```

This command produces output similar to the following:

		OPERATIONS		BLOCKS		AVG TIME (ms)	
TYP	NAME	READ	WRITE	READ	WRITE	READ	WRITE
vol	vol1	2421	0	600000	0	99.0	0.0

To obtain and display statistics for the entire cluster, use the following command:

```
# vxstat -b
```

The statistics for all nodes are summed. For example, if node 1 performed 100 I/O operations and node 2 performed 200 I/O operations, `vxstat -b` displays a total of 300 I/O operations.





System administrators often find that gathering and interpreting data about large and complex configurations can be a difficult task. VERITAS Storage Expert (*vxse*) is designed to help in diagnosing configuration problems with VxVM.

Storage Expert consists of a set of simple commands that collect VxVM configuration data and compare it with “best practice.” Storage Expert then produces a summary report that shows which objects do not meet these criteria and makes recommendations for VxVM configuration improvements.

These user-configurable tools help you as an administrator to verify and validate systems and non-optimal configurations in both small and large VxVM installations.

See the following sections for more information about VERITAS Storage Expert:

- ◆ [How Storage Expert Works](#)
- ◆ [Before Using Storage Expert](#)
- ◆ [Running Storage Expert](#)
- ◆ [Identifying Configuration Problems Using Storage Expert](#)
- ◆ [Rule Definitions and Attributes](#)

For more information about Storage Expert, see the *vxse(1M)* manual page.



How Storage Expert Works

Storage Expert components include a set of rule scripts and a rules engine. The rules engine runs the scripts and produces ASCII output, which is organized and archived by Storage Expert's report generator. This output contains information about areas of VxVM configuration that do not meet the set criteria. By default, output is sent to the screen, but you can send it to a file using standard output redirection.

Before Using Storage Expert

Storage Expert is included in the `VRTSvxvm` package. Even if you do not plan to use the VEA graphical user interface, you must also have installed the following packages to run `vxse`:

- ◆ `VRTSob`
- ◆ `VRTSvmpro`

The VEA service must also be started on the system by running the command `/opt/VRTS/bin/vxsvc`. For information about installing these components and starting the VEA service, see the *Installation Guide*.

Running Storage Expert

Note You must have `root` user privileges to run Storage Expert.

Command Line Syntax

Note The executable rule files are located in the directory, `/opt/VRTS/vxse/vxvm`. The examples in this chapter assume that this directory has been added to the `PATH` variable.

The rules are invoked using the following syntax:

```
# rulename [options] keyword [attribute=value ...]
```

Each of the rules performs a different function as listed in "[Rule Definitions and Attributes](#)" on page 393.

The following options may be specified:

- d *defaults_file* Specify an alternate defaults file.
- g *diskgroup* Specify the disk group to be examined.
- v Specify verbose output format.

One of the following keywords must be specified:

- check List the default values used by the rule's attributes.
- info Describe what the rule does.
- list List the attributes of the rule that you can set.
- run Run the rule.

A full list of the Storage Expert rules and their default values are listed in “[Rule Definitions and Attributes](#)” on page 393.

Discovering What a Rule Does

To obtain details about what a rule does, use the `info` keyword, as in the following example:

```
# vxse_stripes2 info
VxVM vxse:vxse_stripes2 INFO V-5-1-6153 This rule checks for stripe
volumes which have too many or too few columns
```

Displaying Rule Attributes and Their Default Values

To see the attributes that are available for a given rule, use the `list` keyword. In the following example, the single attribute, `mirror_threshold`, is shown for the rule `vxse_dr11`:

```
# vxse_dr11 list
VxVM vxse:vxse_dr11 INFO V-5-1-6004
vxse_dr11 - TUNEABLES default values
-----
mirror_threshold - large mirror threshold size
                  Warn if a mirror is of greater
                  than this size and does not have
                  an attached DRL log.
```



To see the default values of a specified rule's attributes, use the `check` keyword as shown here:

```
# vxse_stripes2 check
vxse_stripes2 - TUNEABLES
-----
VxVM vxse:vxse_stripes2 INFO V-5-1-5546
      too_wide_stripe - (16) columns in a striped volume
      too_narrow_stripe - (3) columns in a striped volume
```

Storage Expert lists the default value of each of the rule's attributes.

A full list of rules and the default values of their attributes can be found in [“Rule Definitions and Attributes”](#) on page 393.

To alter the behavior of rules, you can change the value of their attributes as described in the section, [“Setting Rule Attributes”](#) on page 385.

Running a Rule

The `run` keyword invokes a default or reconfigured rule on a disk group or file name, for example:

```
# vxse_dg1 -g mydg run
VxVM vxse:vxse_dg1 INFO V-5-1-5511 vxse_vxdg1 - RESULTS
-----
vxse_dg1 PASS:
Disk group (mydg) okay amount of disks in this disk group (4)
```

This indicates that the specified disk group (`mydg`) met the conditions specified in the rule. See [“Rule Result Types”](#) on page 385 for a list of the possible result types.

Note You can set Storage Expert to run as a `cron` job to notify administrators and automatically archive reports.

Rule Result Types

Running a rule generates output that shows the status of the objects that have been examined against the rule:

INFO	Information about the specified object; for example “RAID-5 does not have a log.”
PASS	The object met the conditions of the rule.
VIOLATION	The object did not meet the conditions of the rule.

Setting Rule Attributes

You can set attributes in the following ways:

- ◆ Enter an attribute on the command line, for example:

```
# vxse_drl2 -g mydg run large_mirror_size=30m
```

- ◆ Create your own defaults file, and specify that file on the command line:

```
# vxse_drl2 -d mydefaultsfile run
```

Lines in this file contain attribute values definitions for a rule in this format:

```
rule_name, attribute=value
```

For example, the following entry defines a value of 20 gigabytes for the attribute `large_mirror_size` of the rule `vxse_drl2`:

```
vxse_drl2, large_mirror_size=20g
```

You can specify values that are to be ignored by inserting a `#` character at the start of the line, for example:

```
#vxse_drl2, large_mirror_size=20g
```

- ◆ Edit the attribute values that are defined in the `/etc/default/vxse` file. If you do this, make a backup copy of the file in case you need to regress your changes.

Attributes are applied using the following order of precedence from highest to lowest:

1. A value specified on the command line.
2. A value specified in a user-defined defaults file.
3. A value in the `/etc/default/vxse` file that has not been commented out.
4. A built-in value defined at compile time.



Identifying Configuration Problems Using Storage Expert

Storage Expert provides a large number of rules that help you to diagnose configuration issues that might cause problems for your storage environment. Each rule describes the issues involved, and suggests remedial actions.

The rules help you to diagnose problems in the following categories:

- ◆ [Recovery Time](#)
- ◆ [Disk Groups](#)
- ◆ [Disk Striping](#)
- ◆ [Disk Sparing and Relocation Management](#)
- ◆ [Hardware Failures](#)
- ◆ [Rootability](#)
- ◆ [System Hostname](#)

A full list of Storage Expert rules, listed in numerical order, can be found in “[Rule Definitions and Attributes](#)” on page 393.

Recovery Time

Several “best practice” rules enable you to check that your storage configuration has the resilience to withstand a disk failure or a system failure.

Checking for Multiple RAID-5 Logs on a Physical Disk (vxse_disklog)

To check whether more than one RAID-5 log exists on the same physical disk, run rule vxse_disklog.

RAID-5 log mirrors for the same physical volume should be located on separate physical disks to ensure redundancy. More than one RAID-5 log on a disk also makes the recovery process longer and more complicated.

Checking for Large Mirror Volumes Without a DRL (vxse_drl1)

To check whether large mirror volumes (larger than 1GB) have an associated dirty region log (DRL), run rule `vxse_drl1`.

Creating a DRL speeds recovery of mirrored volumes after a system crash. A DRL tracks those regions that have changed and uses the tracking information to recover only those portions of the volume that need to be recovered. Without a DRL, recovery is accomplished by copying the full contents of the volume between its mirrors. This process is lengthy and I/O intensive.

For information on adding a DRL log to a mirrored volume, see [“Preparing a Volume for DRL and Instant Snapshots”](#) on page 235.

Checking for Large Mirrored Volumes Without a Mirrored DRL (vxse_drl2)

To check whether a large mirrored volume has a mirrored DRL log, run rule `vxse_drl2`.

Mirroring the DRL log provides added protection in the event of a disk failure.

For information on adding a mirror to a DRL log, see [“Preparing a Volume for DRL and Instant Snapshots”](#) on page 235.

Checking for RAID-5 Volumes Without a RAID-5 Log (vxse_raid5log1)

To check whether a RAID-5 volume has an associated RAID-5 log, run rule `vxse_raid5log1`.

In the event of both a system failure and a failure of a disk in a RAID-5 volume, data that is not involved in an active write could be lost or corrupted if there is no RAID-5 log.

For information about adding a RAID-5 log to a RAID-5 volume, see [“Adding a RAID-5 Log”](#) on page 243.

Checking Minimum and Maximum RAID-5 Log Sizes (vxse_raid5log2)

To check that the size of RAID-5 logs falls within the minimum and maximum recommended sizes, run rule `vxse_raid5log2`.

The recommended minimum and maximum sizes are 64MB and 1GB respectively. If `vxse_raid5log2` reports that the size of the log is outside these boundaries, adjust the size by replacing the log.



Checking for Non-Mirrored RAID-5 Logs (vxse_raid5log3)

To check that the RAID-5 log of a large volume is mirrored, run the vxse_raid5log3 rule.

A mirror of the RAID-5 log protects against loss of data due to the failure of a single disk. You are strongly advised to mirror the log if vxse_raid5log3 reports that the log of a large RAID-5 volume does not have a mirror.

For information on adding a RAID-5 log mirror, see “[Adding a RAID-5 Log](#)” on page 243.

Disk Groups

Disk groups are the basis of VxVM storage configuration so it is critical that the integrity and resilience of your disk groups are maintained. Storage Expert provides a number of rules that enable you to check the status of disk groups and associated objects.

Checking Whether a Configuration Database Is Too Full (vxse_dg1)

To check whether the disk group configuration database has become too full, run rule vxse_dg1.

By default, this rule suggests a limit of 250 for the number of disks in a disk group. If one of your disk groups exceeds this figure, you should consider creating a new disk group. The number of objects that can be configured in a disk group is limited by the size of the private region which stores configuration information about every object in the disk group. Each disk in the disk group that has a private region stores a separate copy of this configuration database.

For information on creating a new disk group, see “[Creating a Disk Group](#)” on page 137.

Checking Disk Group Configuration Copies and Logs (vxse_dg2)

To check whether a disk group has too many or too few disk group configuration copies, and whether a disk group has too many or too few copies of the disk group log, run rule vxse_dg2.

Checking “on disk config” Size (vxse_dg3)

To check whether a disk group has the correct “on disk config” size, run rule vxse_dg3.

Checking Version Number of Disk Groups (vxse_dg4)

To check the version number of a disk group, run rule `vxse_dg4`.

For optimum results, your disk groups should have the latest version number that is supported by the installed version of VxVM.

If a disk group is not at the latest version number, see the section “[Upgrading a Disk Group](#)” on page 169 for information about upgrading it.

Checking the Number of Configuration Copies in a Disk Group (vxse_dg5)

To find out whether a disk group has only a single VxVM configured disk, run rule `vxse_dg5`.

See “[Creating and Administering Disk Groups](#)” on page 131 for more information.

Checking for Non-Imported Disk Groups (vxse_dg6)

To check for disk groups that are visible to VxVM but not imported, run rule `vxse_dg6`.

Importing a disk to a disk group is described in “[Importing a Disk Group](#)” on page 141.

Checking for Initialized VM Disks that are not in a Disk Group (vxse_disk)

To find out whether there are any initialized disks that are not a part of any disk group, run rule `vxse_disk`. This prints out a list of disks, indicating whether they are part of a disk group or unassociated.

For information on how to add a disk to disk group, see “[Adding a Disk to a Disk Group](#)” on page 138.

Checking Volume Redundancy (vxse_redundancy)

To check whether a volume is redundant, run rule `vxse_redundancy`.

This rule displays a list of volumes together with the number of mirrors that are associated with each volume. If `vxse_redundancy` shows that a volume does not have an associated mirror, your data is at risk in the event of a disk failure, and you should rectify the situation by creating a mirror for the volume.

See “[Adding a Mirror to a Volume](#)” on page 231 for information on adding a mirror to a volume.



Checking States of Plexes and Volumes (vxse_volplex)

To check whether your disk groups contain unused objects (such as plexes and volumes), run rule `vxse_volplex`. In particular, this rule notifies you if any of the following conditions exist:

- ◆ disabled plexes
- ◆ detached plexes
- ◆ stopped volumes
- ◆ disabled volumes
- ◆ disabled logs
- ◆ failed plexes
- ◆ volumes needing recovery

If any of these conditions exist, see the following for information on correcting the situation:

- ◆ To re-enable a disabled or detached plex, see [“Reattaching Plexes”](#) on page 191.
- ◆ To re-enable a stopped or disabled volume, see [“Starting a Volume”](#) on page 231.
- ◆ To recover a volume, see the chapter [“Recovery from Hardware Failure”](#) in the *VERITAS Volume Manager Troubleshooting Guide*.

Disk Striping

Striping enables you to enhance your system’s performance. Several rules enable you to monitor important parameters such as the number of columns in a stripe plex or RAID-5 plex, and the stripe unit size of the columns.

Checking the Configuration of Large Mirrored-Stripe Volumes (vxse_mirstripe)

To check whether large mirror-striped volumes should be reconfigured as striped-mirror volumes, run rule `vxse_mirstripe`.

A large mirrored-striped volume should be reconfigured, using `relayout`, as a striped-mirror volume to improve redundancy and enhance recovery time after failure.

To convert a mirrored-striped volume to a striped-mirror volume, see [“Converting Between Layered and Non-Layered Volumes”](#) on page 260.

Checking the Number of Columns in RAID-5 Volumes (vxse_raid5)

To check whether RAID-5 volumes have too few or too many columns, run rule `vxse_raid5`.

By default, this rule assumes that a RAID-5 plex should have more than 4 columns and fewer than 8 columns.

See “[Performing Online Relayout](#)” on page 254 for information on changing the number of columns.

Checking the Stripe Unit Size of Striped Volumes (vxse_stripes1)

By default, rule `vxse_stripes1` reports a violation if a volume’s stripe unit size is not set to an integer multiple of 8KB.

See “[Performing Online Relayout](#)” on page 254 for information on changing the stripe unit size.

Checking the Number of Columns in Striped Volumes (vxse_stripes2)

The default values for the number of columns in a striped plex are 16 and 3. By default, rule `vxse_stripes2` reports a violation if a striped plex in your volume has fewer than 3 columns or more than 16 columns.

See “[Performing Online Relayout](#)” on page 254 for information on changing the number of columns in a striped volume.

Disk Sparing and Relocation Management

The hot-relocation feature of VxVM uses spare disks in a disk group to recreate volume redundancy after disk failure.

Checking the Number of Spare Disks in a Disk Group (vxse_spare)

This “best practice” rule assumes that between 10% and 20% of disks in a disk group should be allocated as spare disks. By default, `vxse_spare` checks that a disk group falls within these limits.

See “[Administering Hot-Relocation](#)” on page 327 for information on managing the pool of spare disks.



Hardware Failures

Checking for Disk and Controller Failures (`vxse_dc_failures`)

Rule `vxse_dc_failures` can be used to discover if the system has any failed disks or disabled controllers.

Rootability

Checking the Validity of Root Mirrors (`vxse_rootmir`)

Rule `vxse_rootmir` can be used to confirm that the root mirrors are set up correctly.

System Hostname

Checking the System Name (`vxse_host`)

Rule `vxse_host` can be used to confirm that the system name (*hostname*) in the file `/etc/vx/volboot` is the same as the name that was assigned to the system when it was booted.

Rule Definitions and Attributes

The tables in this section list rule definitions, and rule attributes and their default values.

Note You can use the `info` keyword to show a description of a rule. See [“Discovering What a Rule Does”](#) on page 383 for details.

Rule Definitions

Rule	Description
<code>vxse_dc_failures</code>	Checks and points out failed disks and disabled controllers.
<code>vxse_dg1</code>	Checks for disk group configurations in which the disk group has become too large.
<code>vxse_dg2</code>	Checks for disk group configurations in which the disk group has too many or too few disk group configuration copies, and if the disk group has too many or too few disk group log copies.
<code>vxse_dg3</code>	Checks disk group configurations to verify that the disk group has the correct “on disk config” size.
<code>vxse_dg4</code>	Checks for disk groups that do not have a current version number, and which may need to be upgraded.
<code>vxse_dg5</code>	Checks for disk groups in which there is only one VxVM configured disk.
<code>vxse_dg6</code>	Checks for disk groups that are seen, but which are not imported.
<code>vxse_disk</code>	Checks for disks that are initialized, but are not part of any disk group.
<code>vxse_disklog</code>	Checks for physical disks that have more than one RAID-5 log.
<code>vxse_drl1</code>	Checks for large mirror volumes that do not have an associated DRL log.
<code>vxse_drl2</code>	Checks for large mirror volumes that do not have DRL log that is mirrored.
<code>vxse_host</code>	Checks that the system “hostname” in the <code>/etc/vx/volboot</code> file matches the hostname that was assigned to the system when it was booted.
<code>vxse_mirstripe</code>	Checks for large mirror-striped volumes that should be striped-mirrors.
<code>vxse_raid5</code>	Checks for RAID-5 volumes that are too narrow or too wide.



Rule Definitions

Rule	Description
vxse_raid5log1	Checks for RAID-5 volumes that do not have an associated log.
vxse_raid5log2	Checks for recommended minimum and maximum RAID-5 log sizes.
vxse_raid5log3	Checks for large RAID-5 volumes that do not have a mirrored RAID-5 log.
vxse_redundancy	Checks the redundancy of volumes.
vxse_rootmir	Checks that all root mirrors are set up correctly.
vxse_spare	Checks that the number of spare disks in a disk group is within the VxVM “Best Practices” thresholds.
vxse_stripes1	Checks for stripe volumes whose stripe unit is not a multiple of the default stripe unit size.
vxse_stripes2	Checks for stripe volumes that have too many or too few columns.
vxse_volplex	Checks for volumes and plexes that are in various states, such as: <ul style="list-style-type: none">◆ disabled plexes◆ detached plexes◆ stopped volumes◆ disabled volumes◆ disabled logs◆ failed plexes◆ volumes needing recovery

Note You can use the `list` and `check` keywords to show what attributes are available for a rule and to display the default values of these attributes. See “[Running a Rule](#)” on page 384 for more information.



Rule Attributes and Default Attribute Values

Rule	Attribute	Default Value	Description
vxse_dc_failures	-	-	No user-configurable variables.
vxse_dg1	max_disks_per_dg	250	Maximum number of disks in a disk group. Warn if a disk group has more disks than this.
vxse_dg2	-	-	No user-configurable variables.
vxse_dg3	-	-	No user-configurable variables.
vxse_dg4	-	-	No user-configurable variables.
vxse_dg5	-	-	No user-configurable variables.
vxse_dg6	-	-	No user-configurable variables.
vxse_disk	-	-	No user-configurable variables.
vxse_disklog	-	-	No user-configurable variables.
vxse_drl1	mirror_threshold	1g (1GB)	Large mirror threshold size. Warn if a mirror is larger than this and does not have an attached DRL log.
vxse_drl2	large_mirror_size	20g (20GB)	Large mirror-stripe threshold size. Warn if a mirror-stripe volume is larger than this.
vxse_host	-	-	No user-configurable variables.
vxse_mirstripe	large_mirror_size	1g (1GB)	Large mirror-stripe threshold size. Warn if a mirror-stripe volume is larger than this.
	nsd_threshold	8	Large mirror-stripe number of subdisks threshold. Warn if a mirror-stripe volume has more subdisks than this.



Rule Attributes and Default Attribute Values

Rule	Attribute	Default Value	Description
vxse_raid5	too_narrow_raid5	4	Minimum number of RAID-5 columns. Warn if actual number of RAID-5 columns is less than this.
	too_wide_raid5	8	Maximum number of RAID-5 columns. Warn if the actual number of RAID-5 columns is greater than this.
vxse_raid5log1	-	-	No user-configurable variables.
vxse_raid5log2	r5_max_size	1g (1GB)	Maximum RAID-5 log check size. Warn if a RAID-5 log is larger than this.
	r5_min_size	64m (64MB)	Minimum RAID-5 log check size. Warn if a RAID-5 log is smaller than this.
vxse_raid5log3	large_vol_size	20g (20GB)	Large RAID-5 volume threshold size. Warn if a RAID-5 volume with a non-mirrored RAID-5 log is larger than this.
vxse_redundancy	volume_redundancy	0	Volume redundancy check. The value of 2 performs a mirror redundancy check. A value of 1 performs a RAID-5 redundancy check. The default value of 0 performs no redundancy check.
vxse_rootmir	-	-	No user-configurable variables.
vxse_spare	max_disk_spare_ratio	20	Maximum percentage of spare disks in a disk group. Warn if the percentage of spare disks is greater than this.
	min_disk_spare_ratio	10	Minimum percentage of spare disks in a disk group. Warn if the percentage of spare disks is less than this.



Rule Attributes and Default Attribute Values

Rule	Attribute	Default Value	Description
vxse_stripes1	default _stripeunit	8k (8KB)	Stripe unit size for stripe volumes. Warn if a stripe does not have a stripe unit which is an integer multiple of this value.
vxse_stripes2	too_narrow_stripe	3	Minimum number of columns in a striped plex. Warn if a striped volume has fewer columns than this.
	too_wide_stripe	16	Maximum number of columns in a striped plex. Warn if a striped volume has more columns than this.
vxse_volplex	-	-	No user-configurable variables.





VERITAS Volume Manager (VxVM) can improve overall system performance by optimizing the layout of data storage on the available hardware. This chapter contains guidelines establishing performance priorities, for monitoring performance, and for configuring your system appropriately.

Performance Guidelines

VxVM allows you to optimize data storage performance using the following two strategies:

- ◆ Balance the I/O load among the available disk drives.
- ◆ Use striping and mirroring to increase I/O bandwidth to the most frequently accessed data.

VxVM also provides data redundancy (through mirroring and RAID-5) that allows continuous access to data in the event of disk failure.

Data Assignment

When deciding where to locate file systems, you, as a system administrator, typically attempt to balance I/O load among the available disk drives. The effectiveness of this approach is limited by the difficulty of anticipating future usage patterns, as well as the inability to split file systems across the drives. For example, if a single file system receives the most disk accesses, moving the file system to another drive also moves the bottleneck to that drive.

VxVM can split volumes across multiple drives. This permits you a finer level of granularity when locating data. After measuring actual access patterns, you can adjust your previous decisions on the placement of file systems. You can reconfigure volumes online without adversely impacting their availability.



Striping

Striping improves access performance by cutting data into slices and storing it on multiple devices that can be accessed in parallel. Striped plexes improve access performance for both read and write operations.

Having identified the most heavily accessed volumes (containing file systems or databases), you can increase access bandwidth to this data by striping it across portions of multiple disks.

The figure, “[Use of Striping for Optimal Data Access](#)” on page 400, shows an example of a single volume (HotVol) that has been identified as a data-access bottleneck. This volume is striped across four disks, leaving the remaining space on these disks free for use by less-heavily used volumes.

Use of Striping for Optimal Data Access

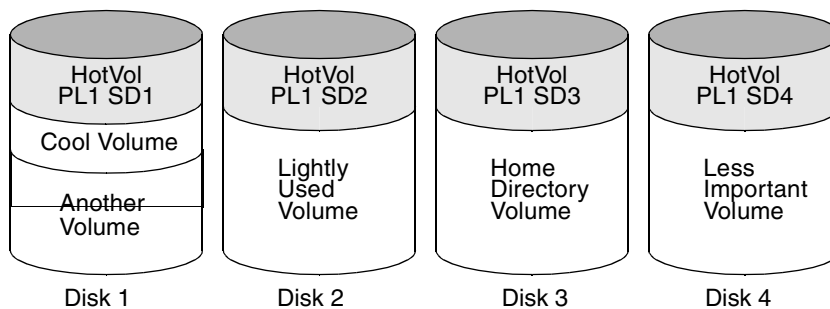

Mirroring

Note You need a full license to use this feature.

Mirroring stores multiple copies of data on a system. When properly applied, mirroring provides continuous availability of data and protection against data loss due to physical media failure. Mirroring improves the chance of data recovery in the event of a system crash or the failure of a disk or other hardware.

In some cases, you can also use mirroring to improve I/O performance. Unlike striping, the performance gain depends on the ratio of reads to writes in the disk accesses. If the system workload is primarily write-intensive (for example, greater than 30 percent writes), mirroring can result in reduced performance.

Combining Mirroring and Striping

Note You need a full license to use this feature.

Mirroring and striping can be used together to achieve a significant improvement in performance when there are multiple I/O streams.

Striping provides better throughput because parallel I/O streams can operate concurrently on separate devices. Serial access is optimized when I/O exactly fits across all stripe units in one stripe.

Because mirroring is generally used to protect against loss of data due to disk failures, it is often applied to write-intensive workloads which degrades throughput. In such cases, combining mirroring with striping delivers both high availability and increased throughput.

A mirrored-stripe volume may be created by striping half of the available disks to form one striped data plex, and striping the remaining disks to form the other striped data plex in the mirror. This is often the best way to configure a set of disks for optimal performance with reasonable reliability. However, the failure of a single disk in one of the plexes makes the entire plex unavailable.

Alternatively, you can arrange equal numbers of disks into separate mirror volumes, and then create a striped plex across these mirror volumes to form a striped-mirror volume (see [“Mirroring Plus Striping \(Striped-Mirror, RAID-1+0 or RAID-10\)”](#) on page 26). The failure of a single disk in a mirror does not take the disks in the other mirrors out of use. A striped-mirror layout is preferred over a mirrored-stripe layout for large volumes or large numbers of disks.

RAID-5

Note You need a full license to use this feature.

RAID-5 offers many of the advantages of combined mirroring and striping, but requires less disk space. RAID-5 read performance is similar to that of striping and RAID-5 parity offers redundancy similar to mirroring. Disadvantages of RAID-5 include relatively slow write performance.

RAID-5 is not usually seen as a way of improving throughput performance except in cases where the access patterns of applications show a high ratio of reads to writes.



Volume Read Policies

To help optimize performance for different types of volumes, VxVM supports the following read policies on data plexes:

- ◆ `round`—a *round-robin* read policy, where all plexes in the volume take turns satisfying read requests to the volume.
- ◆ `prefer`—a *preferred-plex* read policy, where the plex with the highest performance usually satisfies read requests. If that plex fails, another plex is accessed.
- ◆ `select`—default read policy, where the appropriate read policy for the configuration is selected automatically. For example, `prefer` is selected when there is only one striped plex associated with the volume, and `round` is selected in most other cases.

Note You cannot set the read policy on a RAID-5 data plex. RAID-5 plexes have their own read policy (RAID).

For instructions on how to configure the read policy for a volume's data plexes, see [“Changing the Read Policy for Mirrored Volumes”](#) on page 249.

In the configuration example shown in the figure, [“Use of Mirroring and Striping for Improved Performance”](#) on page 402, the read policy of the mirrored-stripe volume labeled `HotVol` is set to `prefer` for the striped plex `PL1`. This policy distributes the load when reading across the otherwise lightly-used disks in `PL1`, as opposed to the single disk in plex `PL2`. (`HotVol` is an example of a mirrored-stripe volume in which one data plex is striped and the other data plex is concatenated.)

Use of Mirroring and Striping for Improved Performance

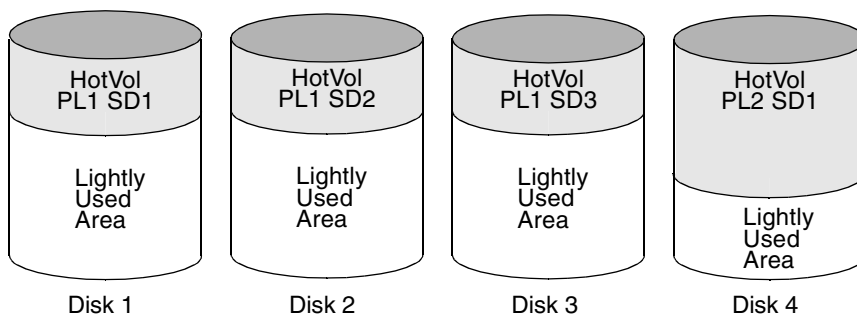

Note To improve performance for read-intensive workloads, you can attach up to 32 data plexes to the same volume. However, this would usually be an ineffective use of disk space for the gain in read performance.

Performance Monitoring

As a system administrator, you have two sets of priorities for setting priorities for performance. One set is *physical*, concerned with hardware such as disks and controllers. The other set is *logical*, concerned with managing software and its operation.

Setting Performance Priorities

The important physical performance characteristics of disk hardware are the relative amounts of I/O on each drive, and the concentration of the I/O within a drive to minimize seek time. Based on monitored results, you can then move the location of subdisks to balance I/O activity across the disks.

The logical priorities involve software operations and how they are managed. Based on monitoring, you may choose to change the layout of certain volumes to improve their performance. You might even choose to reduce overall throughput to improve the performance of certain critical volumes. Only you can decide what is important on your system and what trade-offs you need to make.

Best performance is usually achieved by striping and mirroring all volumes across a reasonable number of disks and mirroring between controllers, when possible. This procedure tends to even out the load between all disks, but it can make VxVM more difficult to administer. For large numbers of disks (hundreds or thousands), set up disk groups containing 10 disks, where each group is used to create a striped-mirror volume. This technique provides good performance while easing the task of administration.

Obtaining Performance Data

VxVM provides two types of performance information: I/O statistics and I/O traces. Each of these can help in performance monitoring. You can obtain I/O statistics using the `vxstat` command, and I/O traces using the `vxtrace` command. A brief discussion of each of these utilities may be found in the following sections.

Tracing Volume Operations

Use the `vxtrace` command to trace operations on specified volumes, kernel I/O object types or devices. The `vxtrace` command either prints kernel I/O errors or I/O trace records to the standard output or writes the records to a file in binary format. Binary trace records written to a file can also be read back and formatted by `vxtrace`.



If you do not specify any operands, `vxtrace` reports either all error trace data or all I/O trace data on all virtual disk devices. With error trace data, you can select all accumulated error trace data, wait for new error trace data, or both of these (this is the default action). Selection can be limited to a specific disk group, to specific VxVM kernel I/O object types, or to particular named objects or devices.

For detailed information about how to use `vxtrace`, refer to the `vxtrace(1M)` manual page.

Printing Volume Statistics

Use the `vxstat` command to access information about activity on volumes, plexes, subdisks, and disks under VxVM control, and to print summary statistics to the standard output. These statistics represent VxVM activity from the time the system initially booted or from the last time the counters were reset to zero. If no VxVM object name is specified, statistics from all volumes in the configuration database are reported.

VxVM records the following I/O statistics:

- ◆ count of operations
- ◆ number of blocks transferred (one operation can involve more than one block)
- ◆ average operation time (which reflects the total time through the VxVM interface and is not suitable for comparison against other statistics programs)

These statistics are recorded for logical I/O including reads, writes, atomic copies, verified reads, verified writes, plex reads, and plex writes for each volume. As a result, one write to a two-plex volume results in at least five operations: one for each plex, one for each subdisk, and one for the volume. Also, one read that spans two subdisks shows at least four reads—one read for each subdisk, one for the plex, and one for the volume.

VxVM also maintains other statistical data. For each plex, it records read and write failures. For volumes, it records corrected read and write failures in addition to read and write failures.

To reset the statistics information to zero, use the `-r` option. This can be done for all objects or for only those objects that are specified. Resetting just prior to an operation makes it possible to measure the impact of that particular operation.

The following is an example of output produced using the `vxstat` command:

TYP	NAME	OPERATIONS		BLOCKS		AVG TIME (ms)	
		READ	WRITE	READ	WRITE	READ	WRITE
vol	blp	0	0	0	0	0.0	0.0
vol	foobarvol	0	0	0	0	0.0	0.0
vol	rootvol	73017	181735	718528	1114227	26.8	27.9
vol	swapvol	13197	20252	105569	162009	25.8	397.0
vol	testvol	0	0	0	0	0.0	0.0

Additional volume statistics are available for RAID-5 configurations.

For detailed information about how to use `vxstat`, refer to the `vxstat(1M)` manual page.

Using Performance Data

When you have gathered performance data, you can use it to determine how to configure your system to use resources most effectively. The following sections provide an overview of how you can use this data.

Using I/O Statistics

Examination of the I/O statistics can suggest how to reconfigure your system. You should examine two primary statistics: volume I/O activity and disk I/O activity.

Before obtaining statistics, reset the counters for all existing statistics using the `vxstat -r` command. This eliminates any differences between volumes or disks due to volumes being created, and also removes statistics from boot time (which are not usually of interest).

After resetting the counters, allow the system to run during typical system activity. Run the application or workload of interest on the system to measure its effect. When monitoring a system that is used for multiple purposes, try not to exercise any one application more than usual. When monitoring a time-sharing system with many users, let statistics accumulate for several hours during the normal working day.

To display volume statistics, enter the `vxstat` command with no arguments. The following is a typical display of volume statistics:

TYP	NAME	OPERATIONS		BLOCKS		AVG TIME (ms)	
		READ	WRITE	READ	WRITE	READ	WRITE
vol	archive	865	807	5722	3809	32.5	24.0
vol	home	2980	5287	6504	10550	37.7	221.1
vol	local	49477	49230	507892	204975	28.5	33.5
vol	rootvol	102906	342664	1085520	1962946	28.1	25.6
vol	src	79174	23603	425472	139302	22.4	30.9
vol	swapvol	22751	32364	182001	258905	25.3	323.2

Such output helps to identify volumes with an unusually large number of operations or excessive read or write times.



To display disk statistics, use the `vxstat -d` command. The following is a typical display of disk statistics:

TYP	NAME	OPERATIONS		BLOCKS		AVG TIME (ms)	
		READ	WRITE	READ	WRITE	READ	WRITE
dm	mydg01	40473	174045	455898	951379	29.5	35.4
dm	mydg02	32668	16873	470337	351351	35.2	102.9
dm	mydg03	55249	60043	780779	731979	35.3	61.2
dm	mydg04	11909	13745	114508	128605	25.0	30.7

If you need to move the volume named `archive` onto another disk, use the following command to identify on which disks it lies:

```
# vxprint -g mydg -tvh archive
```

The following is an extract from typical output:

V	NAME	RVG/VSET/CO	KSTATE	STATE	LENGTH	READPOL	REFPLEX	UTYPE
PL	NAME	VOLUME	KSTATE	STATE	LENGTH	LAYOUT	NCOL/WDTH	MODE
SD	NAME	PLEX	DISK	DISKOFFS	LENGTH	[COL/]OFF	DEVICE	MODE
v	archive	-	ENABLED	ACTIVE	20480	SELECT	-	fsgen
pl	archive-01	archive	ENABLED	ACTIVE	20480	CONCAT	-	RW
sd	mydg03-03	archive-01	mydg03	0	40960	0	c1t2d0	ENA

Note Your system may use device names that differ from these examples. For more information on device names, see [“Administering Disks”](#) on page 59.

The subdisks line (beginning `sd`) indicates that the volume `archive` is on disk `mydg03`. To move the volume off `mydg03`, use the following command:

```
# vxassist -g mydg move archive !mydg03 dest_disk
```

Here *dest_disk* is the destination disk to which you want to move the volume. It is not necessary to specify a destination disk. If you do not specify a destination disk, the volume is moved to an available disk with enough space to contain the volume.

For example, to move a volume from disk `mydg03` to disk `mydg04`, in the disk group, `mydg`, use the following command:

```
# vxassist -g mydg move archive !mydg03 mydg04
```

This command indicates that the volume is to be reorganized so that no part of it remains on `mydg03`.

Tip The VERITAS Enterprise Administrator (VEA) has a graphical user interface (GUI), which provides an easier way to move pieces of volumes between disks. You may find that approach preferable to using the command line.

If two volumes (other than the root volume) on the same disk are busy, move them so that each is on a different disk.

If one volume is particularly busy (especially if it has unusually large average read or write times), stripe the volume (or split the volume into multiple pieces, with each piece on a different disk). If done online, converting a volume to use striping requires sufficient free space to store an extra copy of the volume. If sufficient free space is not available, a backup copy can be made instead. To convert a volume, create a striped plex as a mirror of the volume and then remove the old plex. For example, the following commands stripe the volume `archive` across disks `mydg02`, `mydg03`, and `mydg04` in the disk group, `mydg`, and then remove the original plex `archive-01`:

```
# vxassist -g mydg mirror archive layout=stripe mydg02 mydg03 \
  mydg04
# vxplex -g mydg -o rm dis archive-01
```

After reorganizing any particularly busy volumes, check the disk statistics. If some volumes have been reorganized, clear statistics first and then accumulate statistics for a reasonable period of time.

If some disks appear to be excessively busy (or have particularly long read or write times), you may want to reconfigure some volumes. If there are two relatively busy volumes on a disk, move them closer together to reduce seek times on the disk. If there are too many relatively busy volumes on one disk, move them to a disk that is less busy.

Use I/O tracing (or subdisk statistics) to determine whether volumes have excessive activity in particular regions of the volume. If the active regions can be identified, split the subdisks in the volume and move those regions to a less busy disk.

Caution Striping a volume, or splitting a volume across multiple disks, increases the chance that a disk failure results in failure of that volume. For example, if five volumes are striped across the same five disks, then failure of any one of the five disks requires that all five volumes be restored from a backup. If each volume were on a separate disk, only one volume would need to be restored. Use mirroring or RAID-5 to reduce the chance that a single disk failure results in failure of a large number of volumes.

Note that file systems and databases typically shift their use of allocated space over time, so this position-specific information on a volume is often not useful. Databases are reasonable candidates for moving to non-busy disks if the space used by a particularly busy index or table can be identified.

Examining the ratio of reads to writes helps to identify volumes that can be mirrored to improve their performance. If the read-to-write ratio is high, mirroring can increase performance as well as reliability. The ratio of reads to writes where mirroring can improve performance depends greatly on the disks, the disk controller, whether multiple



controllers can be used, and the speed of the system bus. If a particularly busy volume has a high ratio of reads to writes, it is likely that mirroring can significantly improve performance of that volume.

Using I/O Tracing

I/O statistics provide the data for basic performance analysis; I/O traces serve for more detailed analysis. With an I/O trace, focus is narrowed to obtain an event trace for a specific workload. This helps to explicitly identify the location and size of a hot spot, as well as which application is causing it.

Using data from I/O traces, real work loads on disks can be simulated and the results traced. By using these statistics, you can anticipate system limitations and plan for additional resources.

For information on using the `vxdmpadm` command to gather I/O statistics for a DMP node, path, or enclosure, see [“Gathering and Displaying I/O Statistics”](#) on page 116. You can also use the `vxdmpadm` command to change the I/O load-balancing policy for an enclosure as described in [“Specifying the I/O Policy”](#) on page 120.

Tuning VxVM

This section describes how to adjust the tunable parameters that control the system resources used by VxVM. Depending on the system resources that are available, adjustments may be required to the values of some tunable parameters to optimize performance.

General Tuning Guidelines

VxVM is optimally tuned for most configurations ranging from small systems to larger servers. In cases where tuning can be used to increase performance on larger systems at the expense of a valuable resource (such as memory), VxVM is generally tuned to run on the smallest supported configuration. Any tuning changes must be performed with care, as they may adversely affect overall system performance or may even leave VxVM unusable.

Various mechanisms exist for tuning VxVM. Many parameters can be tuned using the System Administration Manager (SAM) or the `kc tune` utility. Other values can only be tuned using the command line interface to VxVM.

Tuning Guidelines for Large Systems

On smaller systems (with less than a hundred disk drives), tuning is unnecessary and VxVM is capable of adopting reasonable defaults for all configuration parameters. On larger systems, configurations can require additional control over the tuning of these parameters, both for capacity and performance reasons.

Generally, only a few significant decisions must be made when setting up VxVM on a large system. One is to decide on the size of the disk groups and the number of configuration copies to maintain for each disk group. Another is to choose the size of the private region for all the disks in a disk group.

Larger disk groups have the advantage of providing a larger free-space pool for the `vxassist(1M)` command to select from, and also allow for the creation of larger volumes. Smaller disk groups do not require as large a configuration database and so can exist with smaller private regions. Very large disk groups can eventually exhaust the private region size in the disk group with the result that no more configuration objects can be added to that disk group. At that point, the configuration either has to be split into multiple disk groups, or the private regions have to be enlarged. This involves re-initializing each disk in the disk group (and can involve reconfiguring everything and restoring from backup).

A general recommendation for users of disk array subsystems is to create a single disk group for each array so the disk group can be physically moved as a unit between systems.

Number of Configuration Copies for a Disk Group

Selection of the number of configuration copies for a disk group is based on a trade-off between redundancy and performance. As a general rule, reducing the number configuration copies in a disk group speeds up initial access of the disk group, initial startup of the `vxconfigd` daemon, and transactions performed within the disk group. However, reducing the number of configuration copies also increases the risk of complete loss of the configuration database, which results in the loss of all objects in the database and of all data in the disk group.

The default policy for configuration copies in the disk group is to allocate a configuration copy for each controller identified in the disk group, or for each target that contains multiple addressable disks. This provides a sufficient degree of redundancy, but can lead to a large number of configuration copies under some circumstances. If this is the case, we recommended that you limit the number of configuration copies to a maximum of 4. Distribute the copies across separate controllers or targets to enhance the effectiveness of this redundancy.

To set the number of configuration copies for a new disk group, use the `nconfig` operand with the `vxdg init` command (see the `vxdg(1M)` manual page for details).



You can also change the number of copies for an existing group by using the `vxedit set` command (see the `vxedit(1M)` manual page). For example, to configure five configuration copies for the disk group, `bigdg`, use the following command:

```
# vxedit set nconfig=5 bigdg
```

Changing Values of Tunables

Tunables are modified by using SAM or the `kctune` utility. Changed tunables take effect only after relinking the kernel and booting the system from the new kernel.

The values of system tunables can be examined by selecting `Kernel Configuration > Configuration Parameters` in SAM.

Tunable Parameters

The following sections describe specific tunable parameters.

dmp_enable_restore_daemon

Set to 1 to enable the DMP restore daemon; set to 0 to disable.

dmp_failed_io_threshold

The time limit for an I/O request in DMP. If the time exceeds this value, the usual result is to mark the disk as bad.

dmp_pathswitch_blks_shift

The default number of contiguous I/O blocks (expressed as the integer exponent of a power of 2; for example 10 represents 1024 blocks) that are sent along a DMP path to an Active/Active array before switching to the next available path.

The default value of this parameter is set to 10 so that 1024 blocks (1MB) of contiguous I/O are sent over a DMP path before switching. For intelligent disk arrays with internal data caches, better throughput may be obtained by increasing the value of this tunable. For example, for the HDS 9960 A/A array, the optimal value is between 14 and 16 for an I/O activity pattern that consists mostly of sequential reads or writes.

Note This parameter only affects the behavior of the `balanced` I/O policy. A value of 0 disables multipathing for the policy unless the `vxddmpadm` command is used to specify a different partition size as described in [“Specifying the I/O Policy”](#) on page 120.

dmp_restore_daemon_cycles

If the DMP restore policy is `CHECK_PERIODIC`, the number of cycles after which the `CHECK_ALL` policy is called.

dmp_restore_daemon_interval

The time in seconds between two invocations of the DMP Restore Daemon.



dmp_restore_daemon_policy

The DMP restore policy, which can be set to 0 (CHECK_ALL), 1 (CHECK_DISABLED), 2 (CHECK_PERIODIC), or 3 (CHECK_ALTERNATE).

dmp_retry_count

If an inquiry succeeds on a path, but there is an I/O error, the number of retries to attempt on the path.

vol_checkpt_default

The interval at which utilities performing recoveries or resynchronization operations load the current offset into the kernel as a checkpoint. A system failure during such operations does not require a full recovery, but can continue from the last reached checkpoint.

The default value of the checkpoint is 10240 sectors (10MB).

Increasing this size reduces the overhead of checkpointing on recovery operations at the expense of additional recovery following a system failure during a recovery.

vol_default_iodelay

The count in clock ticks for which utilities pause if they have been directed to reduce the frequency of issuing I/O requests, but have not been given a specific delay time. This tunable is used by utilities performing operations such as resynchronizing mirrors or rebuilding RAID-5 columns.

The default for this tunable is 50 ticks.

Increasing this value results in slower recovery operations and consequently lower system impact while recoveries are being performed.

vol_fmr_logsz

The maximum size in kilobytes of the bitmap that Non-Persistent FastResync uses to track changed blocks in a volume. The number of blocks in a volume that are mapped to each bit in the bitmap depends on the size of the volume, and this value changes if the size of the volume is changed. For example, if the volume size is 1 gigabyte and the system block size is 1024 bytes, a `vol_fmr_logsz` value of 4 yields a map contains 32,768 bits, each bit representing one region of 32 blocks.

The larger the bitmap size, the fewer the number of blocks that are mapped to each bit. This can reduce the amount of reading and writing required on resynchronization, at the expense of requiring more non-pageable kernel memory for the bitmap. Additionally, on clustered systems, a larger bitmap size increases the latency in I/O performance, and it

also increases the load on the private network between the cluster members. This is because every other member of the cluster must be informed each time a bit in the map is marked.

Since the region size must be the same on all nodes in a cluster for a shared volume, the value of the `vol_fmr_logsz` tunable on the master node overrides the tunable values on the slave nodes, if these values are different. Because the value of a shared volume can change, the value of `vol_fmr_logsz` is retained for the life of the volume.

In configurations which have thousands of mirrors with attached snapshot plexes, the total memory overhead can represent a significantly higher overhead in memory consumption than is usual for VxVM.

The default value of this tunable is 4KB. The maximum and minimum permitted values are 1KB and 8KB.

Note The value of this tunable does not have any effect on Persistent FastResync.

vol_max_vol

The maximum number of volumes that can be created on the system. This value can be set to between 1 and the maximum number of minor numbers representable in the system.

The default value for this tunable is 16777215.

vol_maxio

The maximum size of logical I/O operations that can be performed without breaking up the request. I/O requests to VxVM that are larger than this value are broken up and performed synchronously. Physical I/O requests are broken up based on the capabilities of the disk device and are unaffected by changes to this maximum logical request limit.

The default value for this tunable is 256 sectors (256KB).

Note The value of `voliomem_maxpool_sz` must be at least 10 times greater than the value of `vol_maxio`.

If DRL sequential logging is configured, the value of `voldrl_min_regionsz` must be set to at least half the value of `vol_maxio`.



vol_maxioctl

The maximum size of data that can be passed into VxVM via an `ioctl` call. Increasing this limit allows larger operations to be performed. Decreasing the limit is not generally recommended, because some utilities depend upon performing operations of a certain size and can fail unexpectedly if they issue oversized `ioctl` requests.

The default value for this tunable is 32768 bytes (32KB).

vol_maxkiocount

The maximum number of I/O operations that can be performed by VxVM in parallel. Additional I/O requests that attempt to use a volume device are queued until the current activity count drops below this value.

The default value for this tunable is 2048.

Because most process threads can only issue a single I/O request at a time, reaching the limit of active I/O requests in the kernel requires 2048 I/O operations to be performed in parallel. Raising this limit is unlikely to provide much benefit except on the largest of systems.

vol_maxparallelio

The number of I/O operations that the `vxconfigd(1M)` daemon is permitted to request from the kernel in a single `VOL_VOLDIO_READ` per `VOL_VOLDIO_WRITE` `ioctl` call.

The default value for this tunable is 256. It is not desirable to change this value.

vol_maxspecialio

The maximum size of an I/O request that can be issued by an `ioctl` call. Although the `ioctl` request itself can be small, it can request a large I/O request be performed. This tunable limits the size of these I/O requests. If necessary, a request that exceeds this value can be failed, or the request can be broken up and performed synchronously.

The default value for this tunable is 256 sectors (256KB).

Raising this limit can cause difficulties if the size of an I/O request causes the process to take more memory or kernel virtual mapping space than exists and thus deadlock. The maximum limit for `vol_maxspecialio` is 20% of the smaller of physical memory or kernel virtual memory. It is inadvisable to go over this limit, because deadlock is likely to occur.

If stripes are larger than `vol_maxspecialio`, full stripe I/O requests are broken up, which prevents full-stripe read/writes. This throttles the volume I/O throughput for sequential I/O or larger I/O requests.

This tunable limits the size of an I/O request at a higher level in VxVM than the level of an individual disk. For example, for an 8 by 64KB stripe, a value of 256KB only allows I/O requests that use half the disks in the stripe; thus, it cuts potential throughput in half. If you have more columns or you have used a larger interleave factor, then your relative performance is worse.

This tunable must be set, as a minimum, to the size of your largest stripe (RAID-0 or RAID-5).

vol_subdisk_num

The maximum number of subdisks that can be attached to a single plex. There is no theoretical limit to this number, but it has been limited to a default value of 4096. This default can be changed, if required.

volcvm_smartsync

If set to 0, `volcvm_smartsync` disables SmartSync on shared disk groups. If set to 1, this parameter enables the use of SmartSync with shared disk groups. See [“SmartSync Recovery Accelerator”](#) on page 44 for more information.

voldrl_max_drtregs

The maximum number of dirty regions that can exist on the system for non-sequential DRL on volumes. A larger value may result in improved system performance at the expense of recovery time. This tunable can be used to regulate the worse-case recovery time for the system following a failure.

The default value for this tunable is 2048.

voldrl_max_seq_dirty

The maximum number of dirty regions allowed for sequential DRL. This is useful for volumes that are usually written to sequentially, such as database logs. Limiting the number of dirty regions allows for faster recovery if a crash occurs.

The default value for this tunable is 3.

voldrl_min_regionsz

The minimum number of sectors for a dirty region logging (DRL) volume region. With DRL, VxVM logically divides a volume into a set of consecutive regions. Larger region sizes tend to cause the cache hit-ratio for regions to improve. This improves the write performance, but it also prolongs the recovery time.



The VxVM kernel currently sets the default value for this tunable to 512 sectors.

Note If DRL sequential logging is configured, the value of `voldrl_min_regionsz` must be set to at least half the value of `vol_maxio`.

voliorem_chunk_size

The granularity of memory chunks used by VxVM when allocating or releasing system memory. A larger granularity reduces CPU overhead due to memory allocation by allowing VxVM to retain hold of a larger amount of memory.

The default size for this tunable is 64KB.

voliorem_maxpool_sz

The maximum memory requested from the system by VxVM for internal purposes. This tunable has a direct impact on the performance of VxVM as it prevents one I/O operation from using all the memory in the system.

VxVM allocates two pools that can grow up to `voliorem_maxpool_sz`, one for RAID-5 and one for mirrored volumes.

A write request to a RAID-5 volume that is greater than `voliorem_maxpool_sz/10` is broken up and performed in chunks of size `voliorem_maxpool_sz/10`.

A write request to a mirrored volume that is greater than `voliorem_maxpool_sz/2` is broken up and performed in chunks of size `voliorem_maxpool_sz/2`.

The default value for this tunable is 4M.

Note The value of `voliorem_maxpool_sz` must be at least 10 times greater than the value of `vol_maxio`.

voliot_errbuf_dflt

The default size of the buffer maintained for error tracing events. This buffer is allocated at driver load time and is not adjustable for size while VxVM is running.

The default size for this buffer is 16384 bytes (16KB).

Increasing this buffer can provide storage for more error events at the expense of system memory. Decreasing the size of the buffer can result in an error not being detected via the tracing device. Applications that depend on error tracing to perform some responsive action are dependent on this buffer.

voliot_iobuf_default

The default size for the creation of a tracing buffer in the absence of any other specification of desired kernel buffer size as part of the trace `ioctl`.

The default size of this tunable is 8192 bytes (8KB).

If trace data is often being lost due to this buffer size being too small, then this value can be tuned to a more generous amount.

voliot_iobuf_limit

The upper limit to the size of memory that can be used for storing tracing buffers in the kernel. Tracing buffers are used by the VxVM kernel to store the tracing event records. As trace buffers are requested to be stored in the kernel, the memory for them is drawn from this pool.

Increasing this size can allow additional tracing to be performed at the expense of system memory usage. Setting this value to a size greater than can readily be accommodated on the system is inadvisable.

The default value for this tunable is 131072 bytes (128KB).

voliot_iobuf_max

The maximum buffer size that can be used for a single trace buffer. Requests of a buffer larger than this size are silently truncated to this size. A request for a maximal buffer size from the tracing interface results (subject to limits of usage) in a buffer of this size.

The default size for this buffer is 65536 bytes (64KB).

Increasing this buffer can provide for larger traces to be taken without loss for very heavily used volumes. Care should be taken not to increase this value above the value for the `voliot_iobuf_limit` tunable value.

voliot_max_open

The maximum number of tracing channels that can be open simultaneously. Tracing channels are clone entry points into the tracing device driver. Each `vxtrace` process running on a system consumes a single trace channel.

The default number of channels is 32. The allocation of each channel takes up approximately 20 bytes even when not in use.



volpagemod_max_memsz

The amount of memory, measured in kilobytes, that is allocated for caching FastResync and cache object metadata. This tunable has a default value of 6144KB (6MB) of physical memory.

Note The memory allocated for this cache is exclusively dedicated to it. It is not available for other processes or applications.

Setting the value of `volpagemod_max_memsz` below 512KB fails if cache objects or volumes that have been prepared for instant snapshot operations are present on the system.

If you do not use the FastResync or DRL features that are implemented using a version 20 DCO volume, the value of `volpagemod_max_memsz` can be set to 0. However, if you subsequently decide to enable these features, you can use the `vxtune` command to change the value to a more appropriate one:

```
# vxtune volpagemod_max_memsz value
```

where the new value is specified in kilobytes. Using the `vxtune` command to adjust the value of `volpagemod_max_memsz` does not persist across system reboots unless you also adjust the value that is configured in the `/stand/system` file.

volraid_minpool_sz

The initial amount of memory that is requested from the system by VxVM for RAID-5 operations. The maximum size of this memory pool is limited by the value of `voliomem_maxpool_sz`.

The default value for this tunable is 16348 sectors (16MB).

volraid_rsrtransmax

The maximum number of transient reconstruct operations that can be performed in parallel for RAID-5. A transient reconstruct operation is one that occurs on a non-degraded RAID-5 volume that has not been predicted. Limiting the number of these operations that can occur simultaneously removes the possibility of flooding the system with many reconstruct operations, and so reduces the risk of causing memory starvation.

The default number of transient reconstruct operations that can be performed in parallel is 1.

Increasing this size improves the initial performance on the system when a failure first occurs and before a detach of a failing object is performed, but can lead to memory starvation.





Commands Summary

A

This appendix summarizes the usage and purpose of important commonly used commands in VERITAS Volume Manager (VxVM). References are included to longer descriptions in the remainder of this book.

Most commands (excepting daemons, library commands and supporting scripts) are linked to the `/usr/sbin` directory from the `/opt/VRTS/bin` directory. It is recommended that you add the following directories to your `PATH` environment variable:

- ◆ If you are using the Bourne or Korn shell (`sh` or `ksh`), use the commands:

```
$ PATH=$PATH:/usr/sbin:/opt/VRTS/bin:/opt/VRTSvxfs/sbin:\
/opt/VRTSdbed/bin:/opt/VRTSdb2ed/bin:/opt/VRTSsybed/bin:\
/opt/VRTSob/bin
$ MANPATH=/usr/share/man:/opt/VRTS/man:$MANPATH
$ export PATH MANPATH
```

- ◆ If you are using a C shell (`csh` or `tcsh`), use the commands:

```
% set path = ( $path /usr/sbin /opt/VRTSvxfs/sbin \
/opt/VRTSdbed/bin /opt/VRTSdb2ed/bin /opt/VRTSsybed/bin \
/opt/VRTSob/bin /opt/VRTS/bin )
% setenv MANPATH /usr/share/man:/opt/VRTS/man:$MANPATH
```

Note If you have not installed database software, you can omit `/opt/VRTSdbed/bin`, `/opt/VRTSdb2ed/bin` and `/opt/VRTSsybed/bin`. Similarly, `/opt/VRTSvxfs/bin` is only required to access some VxFS commands.

VxVM library commands and supporting scripts are located under the `/usr/lib/vxvm` directory hierarchy. You can include these directories in your path if you need to use them on a regular basis.

For detailed information about an individual command, refer to the appropriate manual page in the 1M section. A list of manual pages is provided in “[Online Manual Pages](#)” on page 439. Commands and scripts that are provided to support other commands and scripts, and which are not intended for general use, are not located in `/opt/VRTS/bin` and do not have manual pages.



The following tables summarize the commonly used commands:

- ◆ [“Obtaining Information About Objects in VxVM”](#) on page 423
- ◆ [“Administering Disks”](#) on page 424
- ◆ [“Creating and Administering Disk Groups”](#) on page 426
- ◆ [“Creating and Administering Subdisks”](#) on page 428
- ◆ [“Creating and Administering Plexes”](#) on page 430
- ◆ [“Creating Volumes”](#) on page 432
- ◆ [“Administering Volumes”](#) on page 434
- ◆ [“Monitoring and Controlling Tasks”](#) on page 438

Obtaining Information About Objects in VxVM

Command	Description
<code>vxctl license</code>	List licensed features of VxVM.
<code>vxdisk [-g <i>diskgroup</i>] list [<i>diskname</i>]</code>	Lists disks under control of VxVM. See “Displaying Disk Information” on page 98. Example: # vxdisk -g mydg list
<code>vx dg list [<i>diskgroup</i>]</code>	Lists information about disk groups. See “Displaying Disk Group Information” on page 135. Example: # vxdg list mydg
<code>vx dg -s list</code>	Lists information about shared disk groups. See “Listing Shared Disk Groups” on page 371. Example: # vxdg -s list
<code>vxinfo [-g <i>diskgroup</i>] [<i>volume ...</i>]</code>	Displays information about the accessibility and usability of volumes. See “Listing Unstartable Volumes” in the VERITAS Volume Manager Troubleshooting Guide. Example: # vxinfo -g mydg myvol1 myvol2
<code>vxprint -hrt [-g <i>diskgroup</i>] [<i>object</i>]</code>	Prints single-line information about objects in VxVM. See “Displaying Volume Information” on page 224. Example: # vxprint -g mydg myvol1 myvol2
<code>vxprint -st [-g <i>diskgroup</i>] [<i>subdisk</i>]</code>	Displays information about subdisks. See “Displaying Subdisk Information” on page 176. Example: # vxprint -st -g mydg
<code>vxprint -pt [-g <i>diskgroup</i>] [<i>plex</i>]</code>	Displays information about plexes. See “Displaying Plex Information” on page 184. Example: # vxprint -pt -g mydg



Administering Disks

Command	Description
<code>vxdiskadm</code>	Administers disks in VxVM using a menu-based interface.
<code>vxdiskadd [devicename ...]</code>	Adds a disk specified by device name. See “Using vxdiskadd to Place a Disk Under Control of VxVM” on page 81. Example: <pre># vxdiskadd c0t1d0</pre>
<code>vxedit [-g diskgroup] rename olddisk \ newdisk</code>	Renames a disk under control of VxVM. See “Renaming a Disk” on page 97. Example: <pre># vxedit -g mydg rename mydg03 \ mydg02</pre>
<code>vxedit [-g diskgroup] set \ reserve=on off diskname</code>	Sets aside/does not set aside a disk from use in a disk group. See “Reserving Disks” on page 98. Examples: <pre># vxedit -g mydg set reserve=on \ mydg02 # vxedit -g mydg set reserve=off \ mydg02</pre>
<code>vxedit [-g diskgroup] set \ nohotuse=on off diskname</code>	Does not/does allow free space on a disk to be used for hot-relocation. See “Excluding a Disk from Hot-Relocation Use” on page 337 and “Making a Disk Available for Hot-Relocation Use” on page 338. Examples: <pre># vxedit -g mydg set nohotuse=on \ mydg03 # vxedit -g mydg set nohotuse=off \ mydg03</pre>



Administering Disks

Command	Description
<code>vxedit [-g <i>diskgroup</i>] set \ spare=on off <i>diskname</i></code>	<p>Adds/removes a disk from the pool of hot-relocation spares. See “Marking a Disk as a Hot-Relocation Spare” on page 335 and “Removing a Disk from Use as a Hot-Relocation Spare” on page 336.</p> <p>Examples:</p> <pre># vxedit -g mydg set spare=on \ mydg04 # vxedit -g mydg set spare=off \ mydg04</pre>
<code>vxdisk offline <i>devicename</i></code>	<p>Takes a disk offline. See “Taking a Disk Offline” on page 96.</p> <p>Example:</p> <pre># vxdisk offline c0t1d0</pre>
<code>vx dg -g <i>diskgroup</i> rmdisk <i>diskname</i></code>	<p>Removes a disk from its disk group. See “Removing a Disk from a Disk Group” on page 138.</p> <p>Example:</p> <pre># vx dg -g mydg rmdisk c0t2d0</pre>
<code>vx diskunsetup <i>devicename</i></code>	<p>Removes a disk from control of VxVM. See “Removing a Disk from a Disk Group” on page 138.</p> <p>Example:</p> <pre># vx diskunsetup c0t3d0</pre>



Creating and Administering Disk Groups

Command	Description
<code>vxdg [-s] init <i>diskgroup</i> [<i>diskname=</i>] <i>devicename</i></code>	Creates a disk group using a pre-initialized disk. See “Creating a Disk Group” on page 137 and “Creating a Shared Disk Group” on page 372. Example: <pre># vxdg init mydg mydg01=c0t1d0</pre>
<code>vxsplitlines -g <i>diskgroup</i></code>	Reports conflicting configuration information. See “Handling Conflicting Configuration Copies in a Disk Group” on page 150. Example: <pre># vxsplitlines -g mydg</pre>
<code>vxdg [-n <i>newname</i>] deport <i>diskgroup</i></code>	Deports a disk group and optionally renames it. See “Deporting a Disk Group” on page 139. Example: <pre># vxdg -n newdg deport mydg</pre>
<code>vxdg [-n <i>newname</i>] import <i>diskgroup</i></code>	Imports a disk group and optionally renames it. See “Importing a Disk Group” on page 141. Example: <pre># vxdg -n newdg import mydg</pre>
<code>vxdg [-n <i>newname</i>] -s import <i>diskgroup</i></code>	Imports a disk group as shared by a cluster, and optionally renames it. See “Importing Disk Groups as Shared” on page 373. Example: <pre># vxdg -n newsdg -s import mysdg</pre>
<code>vxdg [-o <i>expand</i>] listmove <i>sourcedg</i> \ <i>targetdg object ...</i></code>	Lists the objects potentially affected by moving a disk group. See “Listing Objects Potentially Affected by a Move” on page 160. Example: <pre># vxdg -o expand listmove mydg \ newdg myvoll</pre>

Creating and Administering Disk Groups

Command	Description
<code>vxdg [-o expand] move <i>sourcedg</i> \ <i>targetdg object ...</i></code>	Moves objects between disk groups. See “Moving Objects Between Disk Groups” on page 163. Example: <pre># vxdg -o expand move mydg newdg \ myvol1</pre>
<code>vxdg [-o expand] split <i>sourcedg</i> \ <i>targetdg object ...</i></code>	Splits a disk group and moves the specified objects into the target disk group. See “Splitting Disk Groups” on page 165. Example: <pre># vxdg -o expand split mydg newdg \ myvol2 myvol3</pre>
<code>vxdg join <i>sourcedg targetdg</i></code>	Joins two disk groups. See “Joining Disk Groups” on page 166. Example: <pre># vxdg join newdg mydg</pre>
<code>vxdg -g <i>diskgroup</i> set \ activation=<i>ew ro sr sw off</i></code>	Sets the activation mode of a shared disk group in a cluster. See “Changing the Activation Mode on a Shared Disk Group” on page 375. Example: <pre># vxdg -g mysdg set activation=sw</pre>
<code>vxrecover -g <i>diskgroup</i> -sb</code>	Starts all volumes in an imported disk group. See “Moving Disk Groups Between Systems” on page 144 for an example of its use. Example: <pre># vxrecover -g mydg -sb</pre>
<code>vxdg destroy <i>diskgroup</i></code>	Destroys a disk group and releases its disks. See “Destroying a Disk Group” on page 168. Example: <pre># vxdg destroy mydg</pre>



Creating and Administering Subdisks

Command	Description
<code>vxmlake [-g <i>diskgroup</i>] sd <i>subdisk</i> \ <i>diskname,offset,length</i></code>	Creates a subdisk. See “Creating Subdisks” on page 175. Example: <pre># vxmlake -g mydg sd mydg02-01 \ mydg02,0,8000</pre>
<code>vxsd [-g <i>diskgroup</i>] assoc <i>plex</i> \ <i>subdisk...</i></code>	Associates subdisks with an existing plex. See “Associating Subdisks with Plexes” on page 178. Example: <pre># vxsd -g mydg assoc home-1 \ mydg02-01 mydg02-00 mydg02-01</pre>
<code>vxsd [-g <i>diskgroup</i>] assoc <i>plex</i> \ <i>subdisk1:0 ... subdiskM:N-1</i></code>	Adds subdisks to the ends of the columns in a striped or RAID-5 volume. See “Associating Subdisks with Plexes” on page 178. Example: <pre># vxsd -g mydg assoc vol01-01 \ mydg10-01:0 mydg11-01:1 mydg12-01:2</pre>
<code>vxsd [-g <i>diskgroup</i>] mv <i>oldsubdisk</i> \ <i>newsubdisk ...</i></code>	Replaces a subdisk. See “Moving Subdisks” on page 176. Example: <pre># vxsd -g mydg mv mydg01-01 \ mydg02-01</pre>
<code>vxsd [-g <i>diskgroup</i>] -s <i>size</i> split \ <i>subdisk sd1 sd2</i></code>	Splits a subdisk in two. See “Splitting Subdisks” on page 177. Example: <pre># vxsd -g mydg -s 1000m split \ mydg03-02 mydg03-02 mydg03-03</pre>
<code>vxsd [-g <i>diskgroup</i>] join <i>sd1 sd2 ...</i> \ <i>subdisk</i></code>	Joins two or more subdisks. See “Joining Subdisks” on page 177. Example: <pre># vxsd -g mydg join mydg03-02 \ mydg03-03 mydg03-02</pre>



Creating and Administering Subdisks

Command	Description
<code>vxassist [-g <i>diskgroup</i>] move \</code> <code>volume !<i>olddisk newdisk</i></code>	Relocates subdisks in a volume between disks. See “Moving and Unrelocating Subdisks Using vxassist” on page 341. Example: <pre># vxassist -g mydg move myvol !mydg02 mydg05</pre>
<code>vxunreloc [-g <i>diskgroup</i>] <i>original_disk</i></code>	Relocates subdisks to their original disks. See “Moving and Unrelocating Subdisks Using vxunreloc” on page 341. Example: <pre># vxunreloc -g mydg mydg01</pre>
<code>vxsd [-g <i>diskgroup</i>] dis <i>subdisk</i></code>	Dissociates a subdisk from a plex. See “Dissociating Subdisks from Plexes” on page 180. Example: <pre># vxsd -g mydg dis mydg02-01</pre>
<code>vxedit [-g <i>diskgroup</i>] rm <i>subdisk</i></code>	Removes a subdisk. See “Removing Subdisks” on page 181. Example: <pre># vxedit -g mydg rm mydg02-01</pre>
<code>vxsd [-g <i>diskgroup</i>] -o rm dis <i>subdisk</i></code>	Dissociates and removes a subdisk from a plex. See “Dissociating Subdisks from Plexes” on page 180. Example: <pre># vxsd -g mydg -o rm dis mydg02-01</pre>



Creating and Administering Plexes

Command	Description
<code>vxmake [-g <i>diskgroup</i>] plex <i>plex</i> \ sd=<i>subdisk1</i>[, <i>subdisk2</i>, ...]</code>	Creates a concatenated plex. See “Creating Plexes” on page 183. Example: <pre># vxmake -g mydg plex vol101-02 \ sd=mydg02-01,mydg02-02</pre>
<code>vxmake [-g <i>diskgroup</i>] plex <i>plex</i> \ layout=<i>stripe</i> <i>raid5</i> stwidth=<i>W</i> \ ncolumn=<i>N</i> sd=<i>subdisk1</i>[, <i>subdisk2</i>, ...]</code>	Creates a striped or RAID-5 plex. See “Creating a Striped Plex” on page 184. Example: <pre># vxmake -g mydg plex pl-01 \ layout=stripe stwidth=32 \ ncolumn=2 sd=mydg01-01,mydg02-01</pre>
<code>vxplex [-g <i>diskgroup</i>] att <i>volume</i> <i>plex</i></code>	Attaches a plex to an existing volume. See “Attaching and Associating Plexes” on page 189 and “Reattaching Plexes” on page 191. Example: <pre># vxplex -g mydg att vol101 vol101-02</pre>
<code>vxplex [-g <i>diskgroup</i>] det <i>plex</i></code>	Detaches a plex. See “Detaching Plexes” on page 191. Example: <pre># vxplex -g mydg det vol101-02</pre>
<code>vxmend [-g <i>diskgroup</i>] off <i>plex</i></code>	Takes a plex offline for maintenance. See “Taking Plexes Offline” on page 190. Example: <pre># vxmend -g mydg off vol102-02</pre>
<code>vxmend [-g <i>diskgroup</i>] on <i>plex</i></code>	Re-enables a plex for use. See “Reattaching Plexes” on page 191. Example: <pre># vxmend -g mydg on vol102-02</pre>
<code>vxplex [-g <i>diskgroup</i>] mv <i>oldplex</i> <i>newplex</i></code>	Replaces a plex. See “Moving Plexes” on page 192. Example: <pre># vxplex -g mydg mv vol102-02 \ vol102-03</pre>



Creating and Administering Plexes

Command	Description
<code>vxplex [-g <i>diskgroup</i>] cp <i>volume newplex</i></code>	Copies a volume onto a plex. See “Copying Plexes” on page 193. Example: <pre># vxplex -g mydg cp vol02 vol103-01</pre>
<code>vxmend [-g <i>diskgroup</i>] fix clean <i>plex</i></code>	Sets the state of a plex in an unstartable volume to CLEAN. See “Reattaching Plexes” on page 191. Example: <pre># vxmend -g mydg fix clean vol102-02</pre>
<code>vxplex [-g <i>diskgroup</i>] -o rm dis <i>plex</i></code>	Dissociates and removes a plex from a volume. See “Dissociating and Removing Plexes” on page 193. Example: <pre># vxplex -g mydg -o rm dis vol103-01</pre>



Creating Volumes

Command	Description
<code>vxassist [-g <i>diskgroup</i>] maxsize \ layout=<i>layout</i> [<i>attributes</i>]</code>	Displays the maximum size of volume that can be created. See “Discovering the Maximum Size of a Volume” on page 202. Example: <pre># vxassist -g mydg maxsize \ layout=raid5 nlog=2</pre>
<code>vxassist -b [-g <i>diskgroup</i>] make \ volume length [layout=<i>layout</i>] [<i>attributes</i>]</code>	Creates a volume. See “Creating a Volume on Any Disk” on page 203 and “Creating a Volume on Specific Disks” on page 203. Example: <pre># vxassist -b -g mydg make myvol \ 20g layout=concat mydg01 mydg02</pre>
<code>vxassist -b [-g <i>diskgroup</i>] make \ volume length layout=mirror \ [nmirror=<i>N</i>] [<i>attributes</i>]</code>	Creates a mirrored volume. See “Creating a Mirrored Volume” on page 209. Example: <pre># vxassist -b -g mydg make mymvol \ 20g layout=mirror nmirror=2</pre>
<code>vxassist -b [-g <i>diskgroup</i>] make \ volume length layout=<i>layout</i> \ exclusive=on [<i>attributes</i>]</code>	Creates a volume that may be opened exclusively by a single node in a cluster. See “Creating Volumes with Exclusive Open Access by a Node” on page 376. Example: <pre># vxassist -b -g mysdg make \ mysmvol 20g layout=mirror \ exclusive=on</pre>
<code>vxassist -b [-g <i>diskgroup</i>] make \ volume length layout={stripe raid5} \ [stripeunit=<i>W</i>] [ncol=<i>N</i>] [<i>attributes</i>]</code>	Creates a striped or RAID-5 volume. See “Creating a Striped Volume” on page 214 and “Creating a RAID-5 Volume” on page 217. Example: <pre># vxassist -b -g mydg make mysvol \ 20g layout=stripe stripeunit=32 ncol=4</pre>

Creating Volumes

Command	Description
<code>vxassist -b [-g <i>diskgroup</i>] make \ <i>volume</i> <i>length</i> layout=mirror \ mirror=ctlr [<i>attributes</i>]</code>	Creates a volume with mirrored data plexes on separate controllers. See “Mirroring across Targets, Controllers or Enclosures” on page 216. Example: <pre># vxassist -b -g mydg make mymcvol \ 20g layout=mirror mirror=ctlr</pre>
<code>vxmake -b [-g <i>diskgroup</i>] -U<i>usage_type</i> \ vol <i>volume</i> [len=<i>length</i>] plex=<i>plex</i>,...</code>	Creates a volume from existing plexes. See “Creating a Volume Using vxmake” on page 218. Example: <pre># vxmake -g mydg -Uraid5 vol r5vol \ plex=raidplex,raidlog1,raidlog2</pre>
<code>vxvol [-g <i>diskgroup</i>] start <i>volume</i></code>	Initializes and starts a volume for use. See “Initializing and Starting a Volume” on page 221 and “Starting a Volume” on page 231. Example: <pre># vxvol -g mydg start r5vol</pre>
<code>vxvol [-g <i>diskgroup</i>] init zero <i>volume</i></code>	Initializes and zeros out a volume for use. See “Initializing and Starting a Volume” on page 221. Example: <pre># vxvol -g mydg init zero myvol</pre>



Administering Volumes

Command	Description
<code>vxassist [-g <i>diskgroup</i>] mirror <i>volume</i> \</code> <code>[<i>attributes</i>]</code>	Adds a mirror to a volume. See “Adding a Mirror to a Volume” on page 231. Example: <pre># vxassist -g mydg mirror myvol \ mydg10</pre>
<code>vxassist [-g <i>diskgroup</i>] remove mirror \</code> <code><i>volume</i> [<i>attributes</i>]</code>	Removes a mirror from a volume. See “Removing a Mirror” on page 233. Example: <pre># vxassist -g mydg remove \ mirror myvol !mydg11</pre>
<code>vxassist [-g <i>diskgroup</i>] {growto growby} \</code> <code><i>volume length</i></code>	Grows a volume to a specified size or by a specified amount. See “Resizing Volumes using vxassist” on page 247. Example: <pre># vxassist -g mydg growby myvol \ 10g</pre>
<code>vxassist [-g <i>diskgroup</i>] \</code> <code>{shrinkto shrinkby} <i>volume length</i></code>	Shrinks a volume to a specified size or by a specified amount. See “Resizing Volumes using vxassist” on page 247. Example: <pre># vxassist -g mydg shrinkto myvol \ 20g</pre>
<code>vxresize -b -F xvfs [-g <i>diskgroup</i>] \</code> <code><i>volume length diskname</i> ...</code>	Resizes a volume and the underlying VERITAS File System. See “Resizing Volumes using vxresize” on page 246. Example: <pre># vxassist -b -F vxfs -g mydg \ myvol 20g mydg10 mydg11</pre>
<code>vxsnap [-g <i>diskgroup</i>] prepare <i>volume</i> \</code> <code>[<i>drl=on sequential off</i>]</code>	Prepares a volume for instant snapshots and for DRL logging. See “Preparing a Volume for DRL and Instant Snapshots” on page 235. Example: <pre># vxsnap -g mydg prepare myvol \ drl=on</pre>

Command	Description
<pre>vxsnap [-g <i>diskgroup</i>] make \ source=<i>volume</i>/newvol=<i>snapvol</i>\ [/nmirror=<i>number</i>]</pre>	<p>Takes a full-sized instant snapshot of a volume by breaking off plexes of the original volume. See “Creating Instant Snapshots” on page 275.</p> <p>Example:</p> <pre># vxsnap -g mydg make \ source=myvol/newvol=mynpvol\ /nmirror=2</pre>
<pre>vxsnap [-g <i>diskgroup</i>] make \ source=<i>volume</i>/snapvol=<i>snapvol</i></pre>	<p>Takes a full-sized instant snapshot of a volume using a prepared empty volume. See “Creating a Volume for Use as a Full-Sized Instant Snapshot” on page 293 and “Creating Instant Snapshots” on page 275.</p> <p>Example:</p> <pre># vxsnap -g mydg make \ source=myvol/snapvol=snpvol</pre>
<pre>vxmake [-g <i>diskgroup</i>] cache \ cache_object cachevolname=<i>volume</i> \ [regionsize=<i>size</i>]</pre>	<p>Creates a cache object for use by space-optimized instant snapshots. See “Creating a Shared Cache Object” on page 294. A cache volume must have already been created, as shown in this example:</p> <pre># vxassist -g mydg make cvol 1g \ layout=mirror init=active \ mydg16 mydg17 # vxmake -g mydg cache cobj \ cachevolname=cvol</pre>
<pre>vxsnap [-g <i>diskgroup</i>] make \ source=<i>volume</i>/newvol=<i>snapvol</i>\ /cache=<i>cache_object</i></pre>	<p>Takes a space-optimized instant snapshot of a volume. See “Creating Instant Snapshots” on page 275.</p> <p>Example:</p> <pre># vxsnap -g mydg make \ source=myvol/newvol=mysosvol\ /cache=cobj</pre>



Administering Volumes

Command	Description
<code>vxsnap [-g <i>diskgroup</i>] refresh <i>snapshot</i></code>	Refreshes a snapshot from its original volume. See “Refreshing an Instant Snapshot (vxsnap refresh)” on page 287. Example: <pre># vxsnap -g mydg refresh mysnpvol</pre>
<code>vxsnap [-g <i>diskgroup</i>] dis <i>snapshot</i></code>	Turns a snapshot into an independent volume. See “Dissociating an Instant Snapshot (vxsnap dis)” on page 289. Example: <pre># vxsnap -g mydg dis mysnpvol</pre>
<code>vxsnap [-g <i>diskgroup</i>] unprepare <i>volume</i></code>	Removes support for instant snapshots and DRL logging from a volume. See “Removing Support for DRL and Instant Snapshots from a Volume” on page 239. Example: <pre># vxsnap -g mydg unprepare myvol</pre>
<code>vxassist [-g <i>diskgroup</i>] relayout <i>volume</i> \ [<i>layout=layout</i>] [<i>relayout_options</i>]</code>	Performs online relayout of a volume. See “Performing Online Relayout” on page 254. Example: <pre># vxassist -g mydg relayout \ vol2 layout=stripe</pre>
<code>vxassist [-g <i>diskgroup</i>] relayout <i>volume</i> \ layout=raid5 stripeunit=<i>W</i> ncol=<i>N</i></code>	Relays out a volume as a RAID-5 volume with stripe width <i>W</i> and <i>N</i> columns. See “Performing Online Relayout” on page 254. Example: <pre># vxassist -g mydg relayout \ vol3 layout=raid5 \ stripeunit=16 ncol=4</pre>
<code>vxrelayout [-g <i>diskgroup</i>] -o bg reverse \ <i>volume</i></code>	Reverses the direction of a paused volume relayout. See “Controlling the Progress of a Relayout” on page 259. Example: <pre># vxrelayout -g mydg -o bg \ reverse vol3</pre>

Administering Volumes

Command	Description
<code>vxassist [-g <i>diskgroup</i>] convert <i>volume</i> \</code> <code>[<i>layout=layout</i>] [<i>convert_options</i>]</code>	Converts between a layered volume and a non-layered volume layout. See “Converting Between Layered and Non-Layered Volumes” on page 260. Example: <pre># vxassist -g mydg convert vol3 \ layout=stripe-mirror</pre>
<code>vxassist [-g <i>diskgroup</i>] remove <i>volume</i> \</code> <code><i>volume</i></code>	Removes a volume. See “Removing a Volume” on page 250. Example: <pre># vxassist -g mydg remove myvol</pre>



Monitoring and Controlling Tasks

Command	Description
<code>command [-g <i>diskgroup</i>] -t <i>tasktag</i> [<i>options</i>] [<i>arguments</i>]</code>	Specifies a task tag to a VxVM command. See “Specifying Task Tags” on page 227. Example: <pre># vxrecover -g mydg -t mytask -b \ mydg05</pre>
<code>vxtask [-h] [-g <i>diskgroup</i>] list</code>	Lists tasks running on a system. See “vxtask Usage” on page 229. Example: <pre># vxtask -h -g mydg list</pre>
<code>vxtask monitor <i>task</i></code>	Monitors the progress of a task. See “vxtask Usage” on page 229. Example: <pre># vxtask monitor mytask</pre>
<code>vxtask pause <i>task</i></code>	Suspends operation of a task. See “vxtask Usage” on page 229. Example: <pre># vxtask pause mytask</pre>
<code>vxtask -p [-g <i>diskgroup</i>] list</code>	Lists all paused tasks. See “vxtask Usage” on page 229. Example: <pre># vxtask -p -g mydg list</pre>
<code>vxtask resume <i>task</i></code>	Resumes a paused task. See “vxtask Usage” on page 229. Example: <pre># vxtask resume mytask</pre>
<code>vxtask abort <i>task</i></code>	Cancels a task and attempts to reverse its effects. See “vxtask Usage” on page 229. Example: <pre># vxtask abort mytask</pre>



Online Manual Pages

Manual pages are organized into three sections:

- ◆ [Section 1M — Administrative Commands](#)
- ◆ [Section 4 — File Formats](#)
- ◆ [Section 7 — Device Driver Interfaces](#)

Section 1M — Administrative Commands

Manual pages in section 1M describe commands that are used to administer VERITAS Volume Manager.

Section 1M Manual Pages

Name	Description
<code>dgcfgbackup</code>	Create or update VxVM volume group configuration backup file.
<code>dgcfgdaemon</code>	Start the VxVM configuration backup daemon.
<code>dgcfgrestore</code>	Display or restore VxVM disk group configuration from backup.
<code>vgrestore</code>	Restore a VxVM disk group back to an LVM volume group.
<code>vx_emerg_start</code>	Start VERITAS Volume Manager from recovery media.
<code>vxassist</code>	Create, relayout, convert, mirror, backup, grow, shrink, delete, and move volumes.
<code>vxbootsetup</code>	Set up system boot information on a VERITAS Volume Manager disk.
<code>vxbrk_rootmir</code>	Break off a mirror of a VxVM root disk to create a separate root disk generation.
<code>vxcache</code>	Administer the cache object for space-optimized snapshots.
<code>vxcached</code>	Resize cache volumes when required.
<code>vxcdsconvert</code>	Make disks and disk groups portable between systems.
<code>vxchg_rootid</code>	Set up VxVM root disk that has been cloned or copied from another operational VxVM root disk.



Section 1M Manual Pages

Name	Description
<code>vxclustadm</code>	Start, stop, and reconfigure a cluster.
<code>vxcmdlog</code>	Administer command logging.
<code>vxconfigbackup</code>	Back up disk group configuration.
<code>vxconfigbackupd</code>	Disk group configuration backup daemon.
<code>vxconfigd</code>	VERITAS Volume Manager configuration daemon
<code>vxconfigrestore</code>	Restore disk group configuration.
<code>vxcp_lvmroot</code>	Copy LVM root disk onto new VERITAS Volume Manager root disk.
<code>vxdarestore</code>	Restore simple or nopriv disk access records.
<code>vxdco</code>	Perform operations on version 0 DCO objects and DCO volumes.
<code>vxctl</code>	Control the volume configuration daemon.
<code>vxddladm</code>	Device Discovery Layer subsystem administration.
<code>vxdestroy_lvmroot</code>	Remove LVM root disk and associated LVM volume group.
<code>vxdg</code>	Manage VERITAS Volume Manager disk groups.
<code>vxdisk</code>	Define and manage VERITAS Volume Manager disks.
<code>vxdiskadd</code>	Add one or more disks for use with VERITAS Volume Manager.
<code>vxdiskadm</code>	Menu-driven VERITAS Volume Manager disk administration.
<code>vxdisksetup</code>	Configure a disk for use with VERITAS Volume Manager.
<code>vxdiskunsetup</code>	Deconfigure a disk from use with VERITAS Volume Manager.
<code>vxmpadm</code>	DMP subsystem administration.
<code>vxmpinq</code>	Display SCSI inquiry data.
<code>vxedit</code>	Create, remove, and modify VERITAS Volume Manager records.

Section 1M Manual Pages

Name	Description
<code>vxevac</code>	Evacuate all volumes from a disk.
<code>vximportdg</code>	Import a disk group into the VERITAS Volume Manager configuration.
<code>vxinfo</code>	Print accessibility and usability of volumes.
<code>vxinstall</code>	Menu-driven VERITAS Volume Manager initial configuration.
<code>vxintro</code>	Introduction to the VERITAS Volume Manager utilities.
<code>vxiod</code>	Start, stop, and report on VERITAS Volume Manager kernel daemons.
<code>vxmake</code>	Create VERITAS Volume Manager configuration records.
<code>vxmemstat</code>	Display memory statistics for VERITAS Volume Manager.
<code>vxmend</code>	Mend simple problems in configuration records.
<code>vxmirror</code>	Mirror volumes on a disk or control default mirroring.
<code>vxnotify</code>	Display VERITAS Volume Manager configuration events.
<code>vxpfto</code>	Set Powerfail Timeout (pfto).
<code>vxplex</code>	Perform VERITAS Volume Manager operations on plexes.
<code>vxpool</code>	Create and administer ISP storage pools.
<code>vxprint</code>	Display records from the VERITAS Volume Manager configuration.
<code>vxr5check</code>	Verify RAID-5 volume parity.
<code>vxreattach</code>	Reattach disk drives that have become accessible again.
<code>vxrecover</code>	Perform volume recovery operations.
<code>vxrelayout</code>	Convert online storage from one layout to another.
<code>vxrelocd</code>	Monitor VERITAS Volume Manager for failure events and relocate failed subdisks.
<code>vxres_lvmroot</code>	Restore LVM root disk from VERITAS Volume Manager root disk.



Section 1M Manual Pages

Name	Description
<code>vxresize</code>	Change the length of a volume containing a file system.
<code>vxrootmir</code>	Create a mirror of a VERITAS Volume Manager root disk.
<code>vxsd</code>	Perform VERITAS Volume Manager operations on subdisks.
<code>vxse</code>	Storage Expert rules.
<code>vxsnap</code>	Enable DRL on a volume, and create and administer instant snapshots.
<code>vxsplitlines</code>	Show disks with conflicting configuration copies in a cluster.
<code>vxstat</code>	VERITAS Volume Manager statistics management utility.
<code>vxtask</code>	List and administer VERITAS Volume Manager tasks.
<code>vxtemplate</code>	Install and administer ISP volume templates and template sets.
<code>vxtrace</code>	Trace operations on volumes.
<code>vxtranslog</code>	Administer transaction logging.
<code>vxtune</code>	Adjust VERITAS Volume Replicator and VERITAS Volume Manager tunables.
<code>vxunreloc</code>	Move a hot-relocated subdisk back to its original disk.
<code>vxusertemplate</code>	Create and administer ISP user templates.
<code>vxvmboot</code>	Prepare VERITAS Volume Manager volume as a root, boot, primary swap or dump volume.
<code>vxvmconvert</code>	Convert LVM volume groups to VxVM disk groups.
<code>vxvol</code>	Perform VERITAS Volume Manager operations on volumes.
<code>vxvoladm</code>	Create and administer ISP application volumes on allocated storage.
<code>vxvoladmtask</code>	Administer ISP tasks.
<code>vxvset</code>	Create and administer volume sets.

Section 4 — File Formats

Manual pages in section 4 describe the format of files that are used by VERITAS Volume Manager.

Section 4 Manual Pages

Name	Description
vol_pattern	Disk group search specifications.
vxmlake	vxmlake description file.

Section 7 — Device Driver Interfaces

Manual pages in section 7 describe the interfaces to VERITAS Volume Manager devices.





Configuring VERITAS Volume Manager

B

This appendix provides guidelines for setting up efficient storage management after installing the VERITAS Volume Manager software.

This chapter describes:

- ◆ [Setup Tasks After Installation](#)
- ◆ [Adding Unsupported Disk Arrays as JBODS](#)
- ◆ [Adding Foreign Devices](#)
- ◆ [Adding Disks to Disk Groups](#)
- ◆ [Guidelines for Configuring Storage](#)
- ◆ [Controlling VxVM's View of Multipathed Devices](#)
- ◆ [Configuring Cluster Support](#)
- ◆ [Reconfiguration Tasks](#)

Setup Tasks After Installation

The setup sequence listed below is a typical example. Your system requirements may differ.

▼ Initial Setup Tasks

1. Create disk groups by placing disks under VERITAS Volume Manager control.
2. If you intend to use the Intelligent Storage Provisioning (ISP) feature, create storage pools within the disk groups.
3. Create volumes in the disk groups.
4. Configure file systems on the volumes.



▼ **Optional Setup Tasks**

- ◆ Place the `root` disk under VxVM control and mirror it to create an alternate boot disk.
- ◆ Designate hot-relocation spare disks in each disk group.
- ◆ Add mirrors to volumes.
- ◆ Configure DRL and FastResync on volumes.

▼ **Maintenance Tasks**

- ◆ Resize volumes and file systems.
- ◆ Add more disks, create new disk groups, and create new volumes.
- ◆ Create and maintain snapshots.

Adding Unsupported Disk Arrays as JBODS

After installation, add any disk arrays that are unsupported by VERITAS to the DISKS (JBOD) category as described in “[Administering the Device Discovery Layer](#)” on page 66.

Adding Foreign Devices

The device discovery feature of VxVM can discover some devices that are controlled by third-party drivers, such as for EMC PowerPath. For these devices it may be preferable to use the multipathing capability that is provided by the third-party drivers rather than using the Dynamic Multipathing (DMP) feature. Provided that a suitable array support library is available, DMP can co-exist with such drivers. Other foreign devices, for which a compatible ASL does not exist, can be made available to VERITAS Volume Manager as simple disks by using the `vxddladm addforeign` command. This also has the effect of bypassing DMP. Refer to “[Administering the Device Discovery Layer](#)” on page 66 for more information.

Adding Disks to Disk Groups

To place disks in disk groups, use VEA or the `vxdiskadm` program after completing the installation. Refer to “[Adding a Disk to VxVM](#)” on page 77 and the VEA online help for information on how to add your disks to new disk groups.

See the *VERITAS Storage Foundation Intelligent Storage Provisioning Administrator's Guide* for information about creating storage pools within disk groups. Storage pools are only required if you intend using the ISP feature of VxVM.

Guidelines for Configuring Storage

The following general guidelines help you understand and plan an efficient storage management system.

Guidelines for Protecting Your System and Data

A disk failure can cause loss of data on the failed disk and loss of access to your system. Loss of access is due to the failure of a key disk used for system operations. VERITAS Volume Manager can protect your system from these problems.

To maintain system availability, data important to running and booting your system must be mirrored. The data must be preserved so it can be used in case of failure.

The following are suggestions for protecting your system and data:

- ◆ Perform regular backups to protect your data. Backups are necessary if all copies of a volume are lost or corrupted. Power surges can damage several (or all) disks on your system. Also, typing a command in error can remove critical files or damage a file system directly. Performing regular backups ensures that lost or corrupted data is available to be retrieved.
- ◆ Place the disk containing the `root` file system (the root or boot disk) under VERITAS Volume Manager control. Mirror the root disk so that an alternate root disk exists for booting purposes. By mirroring disks critical to booting, you ensure that no single disk failure leaves your system unbootable and unusable. For more information, see [“Rootability”](#) on page 82.
- ◆ Use mirroring to protect data against loss from a disk failure. See [“Mirroring Guidelines”](#) on page 448 for details.
- ◆ Use the DRL feature to speed up recovery of mirrored volumes after a system crash. See [“Dirty Region Logging \(DRL\) Guidelines”](#) on page 448 for details.
- ◆ Use striping to improve the I/O performance of volumes. See [“Striping Guidelines”](#) on page 449 for details.
- ◆ Make sure enough disks are available for a combined striped and mirrored configuration. At least two disks are required for the striped plex, and one or more additional disks are needed for the mirror.
- ◆ When combining striping and mirroring, never place subdisks from one plex on the same physical disk as subdisks from the other plex.
- ◆ Use logging to prevent corruption of recovery data in RAID-5 volumes. Make sure that each RAID-5 volume has at least one log plex. See [“RAID-5 Guidelines”](#) on page 450 for details.



- ◆ Leave the VERITAS Volume Manager hot-relocation feature enabled. See [“Hot-Relocation Guidelines”](#) on page 450 for details.

Mirroring Guidelines

Refer to the following guidelines when using mirroring.

- ◆ Do not place subdisks from different plexes of a mirrored volume on the same physical disk. This action compromises the availability benefits of mirroring and degrades performance. Using the `vxassist` or `vxdiskadm` commands precludes this from happening.
- ◆ To provide optimum performance improvements through the use of mirroring, at least 70 percent of physical I/O operations should be read operations. A higher percentage of read operations results in even better performance. Mirroring may not provide a performance increase or may even result in performance decrease in a write-intensive workload environment.

Note The operating system implements a file system cache. Read requests can frequently be satisfied from the cache. This can cause the read/write ratio for physical I/O operations through the file system to be biased toward writing (when compared to the read/write ratio at the application level).

- ◆ Where possible, use disks attached to different controllers when mirroring or striping. Most disk controllers support overlapped seeks. This allows seeks to begin on two disks at once. Do not configure two plexes of the same volume on disks that are attached to a controller that does not support overlapped seeks. This is important for older controllers or SCSI disks that do not cache on the drive. It is less important for modern SCSI disks and controllers. Mirroring across controllers allows the system to survive a failure of one of the controllers. Another controller can continue to provide data from a mirror.
- ◆ A plex exhibits superior performance when striped or concatenated across multiple disks, or when located on a much faster device. Set the read policy to prefer the faster plex. By default, a volume with one striped plex is configured to prefer reading from the striped plex.

For more information, see [“Mirroring \(RAID-1\)”](#) on page 25.

Dirty Region Logging (DRL) Guidelines

Dirty Region Logging (DRL) can speed up recovery of mirrored volumes following a system crash. When DRL is enabled, VERITAS Volume Manager keeps track of the regions within a volume that have changed as a result of writes to a plex.

Note Using Dirty Region Logging can impact system performance in a write-intensive environment.

For more information, see “[Dirty Region Logging \(DRL\)](#)” on page 42.

Striping Guidelines

Refer to the following guidelines when using striping.

- ◆ Do not place more than one column of a striped plex on the same physical disk.
- ◆ Calculate stripe-unit sizes carefully. In general, a moderate stripe-unit size (for example, 64 kilobytes, which is also the default used by `vxassist`) is recommended.
- ◆ If it is not feasible to set the stripe-unit size to the track size, and you do not know the application I/O pattern, use the default stripe-unit size.

Note Many modern disk drives have *variable geometry*. This means that the track size differs between cylinders, so that outer disk tracks have more sectors than inner tracks. It is therefore not always appropriate to use the track size as the stripe-unit size. For these drives, use a moderate stripe-unit size (such as 64 kilobytes), unless you know the I/O pattern of the application.

- ◆ Volumes with small stripe-unit sizes can exhibit poor sequential I/O latency if the disks do not have synchronized spindles. Generally, striping over disks without synchronized spindles yields better performance when used with larger stripe-unit sizes and multi-threaded, or largely asynchronous, random I/O streams.
- ◆ Typically, the greater the number of physical disks in the stripe, the greater the improvement in I/O performance; however, this reduces the effective mean time between failures of the volume. If this is an issue, combine striping with mirroring to combine high-performance with improved reliability.
- ◆ If only one plex of a mirrored volume is striped, set the policy of the volume to `prefer` for the striped plex. (The default read policy, `select`, does this automatically.)
- ◆ If more than one plex of a mirrored volume is striped, configure the same stripe-unit size for each striped plex.
- ◆ Where possible, distribute the subdisks of a striped volume across drives connected to different controllers and buses.
- ◆ Avoid the use of controllers that do not support overlapped seeks. (Such controllers are rare.)

The `vxassist` command automatically applies and enforces many of these rules when it allocates space for striped plexes in a volume.



For more information, see “[Striping \(RAID-0\)](#)” on page 21.

RAID-5 Guidelines

Refer to the following guidelines when using RAID-5.

In general, the guidelines for mirroring and striping together also apply to RAID-5. The following guidelines should also be observed with RAID-5:

- ◆ Only one RAID-5 plex can exist per RAID-5 volume (but there can be multiple log plexes).
- ◆ The RAID-5 plex must be derived from at least three subdisks on three or more physical disks. If any log plexes exist, they must belong to disks other than those used for the RAID-5 plex.
- ◆ RAID-5 logs can be mirrored and striped.
- ◆ If the volume length is not explicitly specified, it is set to the length of any RAID-5 plex associated with the volume; otherwise, it is set to zero. If you specify the volume length, it must be a multiple of the stripe-unit size of the associated RAID-5 plex, if any.
- ◆ If the log length is not explicitly specified, it is set to the length of the smallest RAID-5 log plex that is associated, if any. If no RAID-5 log plexes are associated, it is set to zero.
- ◆ Sparse RAID-5 log plexes are not valid.
- ◆ RAID-5 volumes are not supported for sharing in a cluster.

For more information, see “[RAID-5 \(Striping with Parity\)](#)” on page 29.

Hot-Relocation Guidelines

Hot-relocation automatically restores redundancy and access to mirrored and RAID-5 volumes when a disk fails. This is done by relocating the affected subdisks to disks designated as spares and/or free space in the same disk group.

The hot-relocation feature is enabled by default. The associated daemon, `vxrelocd`, is automatically started during system startup.

Refer to the following guidelines when using hot-relocation.

- ◆ The hot-relocation feature is enabled by default. Although it is possible to disable hot-relocation, it is advisable to leave it enabled. It will notify you of the nature of the failure, attempt to relocate any affected subdisks that are redundant, and initiate recovery procedures.

- ◆ Although hot-relocation does not require you to designate disks as spares, designate at least one disk as a spare within each disk group. This gives you some control over which disks are used for relocation. If no spares exist, VERITAS Volume Manager uses any available free space within the disk group. When free space is used for relocation purposes, it is possible to have performance degradation after the relocation.
- ◆ After hot-relocation occurs, designate one or more additional disks as spares to augment the spare space. Some of the original spare space may be occupied by relocated subdisks.
- ◆ If a given disk group spans multiple controllers and has more than one spare disk, set up the spare disks on different controllers (in case one of the controllers fails).
- ◆ For a mirrored volume, configure the disk group so that there is at least one disk that does not already contain a mirror of the volume. This disk should either be a spare disk with some available space or a regular disk with some free space and the disk is not excluded from hot-relocation use.
- ◆ For a mirrored and striped volume, configure the disk group so that at least one disk does not already contain one of the mirrors of the volume or another subdisk in the striped plex. This disk should either be a spare disk with some available space or a regular disk with some free space and the disk is not excluded from hot-relocation use.
- ◆ For a RAID-5 volume, configure the disk group so that at least one disk does not already contain the RAID-5 plex (or one of its log plexes) of the volume. This disk should either be a spare disk with some available space or a regular disk with some free space and the disk is not excluded from hot-relocation use.
- ◆ If a mirrored volume has a DRL log subdisk as part of its data plex, you cannot relocate the data plex. Instead, place log subdisks in log plexes that contain no data.
- ◆ Hot-relocation does not guarantee to preserve the original performance characteristics or data layout. Examine the locations of newly-relocated subdisks to determine whether they should be relocated to more suitable disks to regain the original performance benefits.
- ◆ Although it is possible to build VERITAS Volume Manager objects on spare disks (using `vxmake` or the VEA interface), it is recommended that you use spare disks for hot-relocation only.

See “[Administering Hot-Relocation](#)” on page 327 for more information.



Accessing Volume Devices

As soon as a volume has been created and initialized, it is available for use as a virtual disk partition by the operating system for the creation of a file system, or by application programs such as relational databases and other data management software.

Creating a volume in a disk group sets up block and character (raw) device files that can be used to access the volume:

`/dev/vx/dsk/diskgroup/volume` block device file for *volume*

`/dev/vx/rdsk/diskgroup/volume` character device file for *volume*

The pathnames include a directory named for the disk group. Use the appropriate device node to create, mount and repair file systems, and to lay out databases that require raw partitions.

Controlling VxVM's View of Multipathed Devices

To control how a device is treated by the Dynamic Multipathing (DMP) feature of VxVM, use the `vxdiskadm` command as described in [“Disabling and Enabling Multipathing for Specific Devices”](#) on page 106.

Configuring Cluster Support

The VERITAS Volume Manager software includes an *optional* cluster feature that enables it to be used in a cluster environment. The cluster functionality in VERITAS Volume Manager allows multiple hosts to simultaneously access and manage a set of disks under VERITAS Volume Manager control. A *cluster* is a set of hosts sharing a set of disks; each host is referred to as a *node* in the cluster.

Note The VERITAS Volume Manager cluster feature requires a license, which can be obtained from your Customer Support channel.

For information about enabling cluster functionality in VERITAS Volume Manager, refer to the *VERITAS Storage Solutions Getting Started Guide*.

Configuring Shared Disk Groups

This section describes how to configure shared disks in a cluster. If you are installing VERITAS Volume Manager for the first time or adding disks to an existing cluster, you need to configure new shared disks.

If you are setting up VERITAS Volume Manager for the first time, configure the shared disks using the following procedure:

1. Start the cluster on one node only to prevent access by other nodes.
2. On one node, run the `vxdiskadm` program and choose option 1 to initialize new disks. When asked to add these disks to a disk group, choose `none` to leave the disks for future use.
3. On other nodes in the cluster, run `vxctl enable` to see the newly initialized disks.
4. From the master node, create disk groups on the shared disks. To determine if a node is a master or slave, run the command `vxctl -c mode`.

Use the `vxdg` command or VEA to create disk groups. If you use the `vxdg` command, specify the `-s` option to create shared disk groups.

5. From the master node only, use `vxassist` or VEA to create volumes in the disk groups.

Note RAID-5 volumes are not supported for sharing in a cluster.

6. If the cluster is only running with one node, bring up the other cluster nodes. Enter the `vxdlst` command on each node to display the shared disk groups.

Converting Existing VxVM Disk Groups to Shared Disk Groups

To convert existing disk groups to shared disk groups:

1. Start the cluster on one node only to prevent access by other nodes.
2. Configure the disk groups using the following procedure.

To list all disk groups, use the following command:

```
# vxdg list
```

To deport the disk groups that are to be shared, use the following command:

```
# vxdg deport diskgroup
```



To import disk groups to be shared, use the following command:

```
# vxdbg -s import diskgroup
```

This procedure marks the disks in the shared disk groups as shared and stamps them with the ID of the cluster, enabling other nodes to recognize the shared disks.

If dirty region logs exist, ensure they are active. If not, replace them with larger ones.

To display the shared flag for all the shared disk groups, use the following command:

```
# vxdbg list
```

The disk groups are now ready to be shared.

3. Bring up the other cluster nodes. Enter the `vxdbg list` command on each node to display the shared disk groups. This command displays the same list of shared disk groups displayed earlier.

For information on converting disk groups in a VERITAS Cluster File System (CFS) environment, see the *VERITAS Cluster File System Installation and Configuration Guide*.

Reconfiguration Tasks

The following sections describe tasks that allow you to make changes to the configuration that you specified during installation.

Changing the Name of the Default Disk Group

If you use the VERITAS installer to install the VERITAS Volume Manager software, you can enter the name of the default disk group. This disk group will be used by commands if you do not specify the `-g` option, or the `VXVM_DEFAULTDG` environment variable is not set. If required, you can use the `vxdcctl defaultdg` command to change the default disk group. See [“Displaying and Specifying the System-Wide Default Disk Group”](#) on page 134 for details.

Enabling or Disabling Enclosure-Based Naming

If you use the VERITAS installer to install the VERITAS Volume Manager software, you can choose whether the displayed disk access names are based on device names or on names that you assign to disk enclosures. If required, you can use the `vxdiskadm` or `vxddladm` commands to change the naming convention that is used. See [“Changing the Disk-Naming Scheme”](#) on page 72 for more information.

Glossary

Active/Active disk arrays

This type of multipathed disk array allows you to access a disk in the disk array through all the paths to the disk simultaneously, without any performance degradation.

Active/Passive disk arrays

This type of multipathed disk array allows one path to a disk to be designated as primary and used to access the disk at any time. Using a path other than the designated active path results in severe performance degradation in some disk arrays. Also see [path](#), [primary path](#), and [secondary path](#).

associate

The process of establishing a relationship between VxVM objects; for example, a subdisk that has been created and defined as having a starting point within a plex is referred to as being associated with that plex.

associated plex

A plex associated with a volume.

associated subdisk

A subdisk associated with a plex.

atomic operation

An operation that either succeeds completely or fails and leaves everything as it was before the operation was started. If the operation succeeds, all aspects of the operation take effect at once and the intermediate states of change are invisible. If any aspect of the operation fails, then the operation aborts without leaving partial changes.

In a cluster, an atomic operation takes place either on all nodes or not at all.

attached

A state in which a VxVM object is both associated with another object and enabled for use.



block

The minimum unit of data transfer to or from a disk or array.

boot disk

A disk that is used for the purpose of booting a system.

boot disk group

A private disk group that contains the disks from which the system may be booted.

bootdg

A reserved disk group name that is an alias for the name of the [boot disk group](#).

clean node shutdown

The ability of a node to leave a cluster gracefully when all access to shared volumes has ceased.

cluster

A set of hosts (each termed a [node](#)) that share a set of disks.

cluster manager

An externally-provided daemon that runs on each node in a cluster. The cluster managers on each node communicate with each other and inform VxVM of changes in cluster membership.

cluster-shareable disk group

A disk group in which access to the disks is shared by multiple hosts (also referred to as a [shared disk group](#)). Also see [private disk group](#).

column

A set of one or more subdisks within a striped plex. Striping is achieved by allocating data alternately and evenly across the columns within a plex.

concatenation

A layout style characterized by subdisks that are arranged sequentially and contiguously.

configuration copy

A single copy of a [configuration database](#).



configuration database

A set of records containing detailed information on existing VxVM objects (such as disk and volume attributes).

data change object (DCO)

A VxVM [object](#) that is used to manage information about the FastResync maps in the [DCO volume](#). Both a DCO object and a DCO volume must be associated with a volume to implement [Persistent FastResync](#) on that volume.

data stripe

This represents the usable data portion of a stripe and is equal to the stripe minus the parity region.

DCO volume

A special volume that is used to hold [Persistent FastResync](#) change maps, and dirty region logs (see [dirty region logging](#)).

detached

A state in which a VxVM object is associated with another object, but not enabled for use.

device name

The device name or address used to access a physical disk, such as `c0t0d0`. The `c#t#d#` syntax identifies the controller, target address, and disk. In a SAN environment, it is more convenient to use *enclosure-based naming*, which forms the device name by concatenating the name of the enclosure (such as `enc0`) with the disk's number within the enclosure, separated by an underscore (for example, `enc0_2`). The term [disk access name](#) can also be used to refer to a device name.

dirty region logging

The method by which the VxVM monitors and logs modifications to a plex as a bitmap of changed regions. For a volumes with a new-style DCO volume, the dirty region log (DRL) is maintained in the DCO volume. Otherwise, the DRL is allocated to an associated subdisk called a *log subdisk*.

disabled path

A path to a disk that is not available for I/O. A path can be *disabled* due to real hardware failures or if the user has used the `vxddmpadm disable` command on that controller.



disk

A collection of read/write data blocks that are indexed and can be accessed fairly quickly. Each disk has a universally unique identifier.

disk access name

An alternative term for a [device name](#).

disk access records

Configuration records used to specify the access path to particular disks. Each disk access record contains a name, a type, and possibly some type-specific information, which is used by VxVM in deciding how to access and manipulate the disk that is defined by the disk access record.

disk array

A collection of disks logically arranged into an object. Arrays tend to provide benefits such as redundancy or improved performance. Also see [disk enclosure](#) and [JBOD](#).

disk array serial number

This is the serial number of the disk array. It is usually printed on the disk array cabinet or can be obtained by issuing a vendor-specific SCSI command to the disks on the disk array. This number is used by the DMP subsystem to uniquely identify a disk array.

disk controller

In the multipathing subsystem of VxVM, the controller (host bus adapter or HBA) or disk array connected to the host, which the Operating System represents as the parent node of a disk.

disk enclosure

An intelligent disk array that usually has a backplane with a built-in Fibre Channel loop, and which permits hot-swapping of disks.

disk group

A collection of disks that share a common configuration. A disk group configuration is a set of records containing detailed information on existing VxVM objects (such as disk and volume attributes) and their relationships. Each disk group has an administrator-assigned name and an internally defined unique ID. The disk group names `bootdg` (an alias for the [boot disk group](#)), `defaultdg` (an alias for the default disk group) and `nodg` (represents no disk group) are reserved.

disk group ID

A unique identifier used to identify a disk group.

disk ID

A universally unique identifier that is given to each disk and can be used to identify the disk, even if it is moved.

disk media name

An alternative term for a [disk name](#).

disk media record

A configuration record that identifies a particular disk, by disk ID, and gives that disk a logical (or administrative) name.

disk name

A logical or administrative name chosen for a disk that is under the control of VxVM, such as `disk03`. The term [disk media name](#) is also used to refer to a disk name.

dissociate

The process by which any link that exists between two VxVM objects is removed. For example, dissociating a subdisk from a plex removes the subdisk from the plex and adds the subdisk to the free space pool.

dissociated plex

A plex dissociated from a volume.

dissociated subdisk

A subdisk dissociated from a plex.

distributed lock manager

A lock manager that runs on different systems in a cluster, and ensures consistent access to distributed resources.

enabled path

A path to a disk that is available for I/O.

encapsulation

A process that converts existing partitions on a specified disk to volumes. Encapsulation does not apply to HP-UX.



enclosure

See [disk enclosure](#).

enclosure-based naming

See [device name](#).

fabric mode disk

A disk device that is accessible on a [Storage Area Network \(SAN\)](#) via a [Fibre Channel](#) switch.

FastResync

A fast resynchronization feature that is used to perform quick and efficient resynchronization of stale mirrors, and to increase the efficiency of the snapshot mechanism. Also see [Persistent FastResync](#) and [Non-Persistent FastResync](#).

Fibre Channel

A collective name for the fiber optic technology that is commonly used to set up a [Storage Area Network \(SAN\)](#).

file system

A collection of files organized together into a structure. The UNIX file system is a hierarchical structure consisting of directories and files.

free space

An area of a disk under VxVM control that is not allocated to any subdisk or reserved for use by any other VxVM object.

free subdisk

A subdisk that is not associated with any plex and has an empty `putil[0]` field.

hostid

A string that identifies a host to VxVM. The *hostid* for a host is stored in its [volboot file](#), and is used in defining ownership of disks and disk groups.

hot-relocation

A technique of automatically restoring redundancy and access to mirrored and RAID-5 volumes when a disk fails. This is done by relocating the affected subdisks to disks designated as spares and/or free space in the same disk group.



hot-swap

Refers to devices that can be removed from, or inserted into, a system without first turning off the power supply to the system.

initiating node

The node on which the system administrator is running a utility that requests a change to VxVM objects. This node initiates a volume reconfiguration.

JBOD

The common name for an unintelligent [disk array](#) which may, or may not, support the hot-swapping of disks. The name is derived from “just a bunch of disks.”

log plex

A plex used to store a RAID-5 log. The term *log plex* may also be used to refer to a Dirty Region Logging plex.

log subdisk

A subdisk that is used to store a dirty region log.

master node

A node that is designated by the software to coordinate certain VxVM operations in a cluster. Any node is capable of being the master node.

mastering node

The node to which a disk is attached. This is also known as a *disk owner*.

mirror

A duplicate copy of a volume and the data therein (in the form of an ordered collection of subdisks). Each mirror consists of one *plex* of the volume with which the mirror is associated.

mirroring

A layout technique that mirrors the contents of a volume onto multiple plexes. Each plex duplicates the data stored on the volume, but the plexes themselves may have different layouts.

multipathing

Where there are multiple physical access paths to a disk connected to a system, the disk is called multipathed. Any software residing on the host, (for example, the DMP driver) that hides this fact from the user is said to provide multipathing functionality.



node

One of the hosts in a cluster.

node abort

A situation where a node leaves a cluster (on an emergency basis) without attempting to stop ongoing operations.

node join

The process through which a node joins a cluster and gains access to shared disks.

Non-Persistent FastResync

A form of [FastResync](#) that cannot preserve its maps across reboots of the system because it stores its change map in memory.

object

An entity that is defined to and recognized internally by VxVM. The VxVM objects are: volume, plex, subdisk, disk, and disk group. There are actually two types of disk objects—one for the physical aspect of the disk and the other for the logical aspect.

parity

A calculated value that can be used to reconstruct data after a failure. While data is being written to a RAID-5 volume, parity is also calculated by performing an *exclusive OR* (XOR) procedure on data. The resulting parity is then written to the volume. If a portion of a RAID-5 volume fails, the data that was on that portion of the failed volume can be recreated from the remaining data and the parity.

parity stripe unit

A RAID-5 volume storage region that contains parity information. The data contained in the parity stripe unit can be used to help reconstruct regions of a RAID-5 volume that are missing because of I/O or disk failures.

partition

The standard division of a physical disk device, as supported directly by the operating system and disk drives.



path

When a disk is connected to a host, the path to the disk consists of the HBA (Host Bus Adapter) on the host, the SCSI or fibre cable connector and the controller on the disk or disk array. These components constitute a path to a disk. A failure on any of these results in DMP trying to shift all I/O for that disk onto the remaining (alternate) paths. Also see [Active/Passive disk arrays](#), [primary path](#) and [secondary path](#).

pathgroup

In case of disks which are not multipathed by `vxmp`, VxVM will see each path as a disk. In such cases, all paths to the disk can be grouped. This way only one of the paths from the group is made visible to VxVM.

Persistent FastResync

A form of [FastResync](#) that can preserve its maps across reboots of the system by storing its change map in a [DCO volume](#) on disk. Also see [data change object \(DCO\)](#).

persistent state logging

A logging type that ensures that only active mirrors are used for recovery purposes and prevents failed mirrors from being selected for recovery. This is also known as *kernel logging*.

physical disk

The underlying storage device, which may or may not be under VxVM control.

plex

A plex is a logical grouping of subdisks that creates an area of disk space independent of physical disk size or other restrictions. Mirroring is set up by creating multiple data plexes for a single volume. Each data plex in a mirrored volume contains an identical copy of the volume data. Plexes may also be created to represent concatenated, striped and RAID-5 volume layouts, and to store volume logs.

primary path

In [Active/Passive disk arrays](#), a disk can be bound to one particular controller on the disk array or owned by a controller. The disk can then be accessed using the path through this particular controller. Also see [path](#) and [secondary path](#).

private disk group

A disk group in which the disks are accessed by only one specific host in a cluster. Also see [shared disk group](#).



private region

A region of a physical disk used to store private, structured VxVM information. The *private region* contains a disk header, a table of contents, and a configuration database. The table of contents maps the contents of the disk. The disk header contains a disk ID. All data in the private region is duplicated for extra reliability.

public region

A region of a physical disk managed by VxVM that contains available space and is used for allocating subdisks.

RAID

A Redundant Array of Independent Disks (RAID) is a disk array set up with part of the combined storage capacity used for storing duplicate information about the data stored in that array. This makes it possible to regenerate the data if a disk failure occurs.

read-writeback mode

A recovery mode in which each read operation recovers plex consistency for the region covered by the read. Plex consistency is recovered by reading data from blocks of one plex and writing the data to all other writable plexes.

root configuration

The configuration database for the root disk group. This is special in that it always contains records for other disk groups, which are used for backup purposes only. It also contains disk records that define all disk devices on the system.

root disk

The disk containing the root file system. This disk may be under VxVM control.

root file system

The initial file system mounted as part of the UNIX kernel startup sequence.

root partition

The disk region on which the root file system resides.

root volume

The VxVM volume that contains the root file system, if such a volume is designated by the system configuration.



rootability

The ability to place the `root` file system and the `swap` device under VxVM control. The resulting volumes can then be mirrored to provide redundancy and allow recovery in the event of disk failure.

secondary path

In [Active/Passive disk arrays](#), the paths to a disk other than the primary path are called secondary paths. A disk is supposed to be accessed only through the primary path until it fails, after which ownership of the disk is transferred to one of the secondary paths. Also see [path](#) and [primary path](#).

sector

A unit of size, which can vary between systems. Sector size is set per device (hard drive, CD-ROM, and so on). Although all devices within a system are usually configured to the same sector size for interoperability, this is not always the case. A sector is commonly 1024 bytes.

shared disk group

A disk group in which access to the disks is shared by multiple hosts (also referred to as a [cluster-shareable disk group](#)). Also see [private disk group](#).

shared volume

A volume that belongs to a shared disk group and is open on more than one node of a cluster at the same time.

shared VM disk

A VM disk that belongs to a shared disk group in a cluster.

slave node

A node that is not designated as the master node of a cluster.

slice

The standard division of a logical disk device. The terms *partition* and *slice* are sometimes used synonymously.

snapshot

A point-in-time copy of a volume (volume snapshot) or a file system (file system snapshot).



spanning

A layout technique that permits a volume (and its file system or database) that is too large to fit on a single disk to be configured across multiple physical disks.

sparse plex

A plex that is not as long as the volume or that has holes (regions of the plex that do not have a backing subdisk).

Storage Area Network (SAN)

A networking paradigm that provides easily reconfigurable connectivity between any subset of computers, disk storage and interconnecting hardware such as switches, hubs and bridges.

stripe

A set of stripe units that occupy the same positions across a series of columns.

stripe size

The sum of the stripe unit sizes comprising a single stripe across all columns being striped.

stripe unit

Equally-sized areas that are allocated alternately on the subdisks (within columns) of each striped plex. In an array, this is a set of logically contiguous blocks that exist on each disk before allocations are made from the next disk in the array. A *stripe unit* may also be referred to as a *stripe element*.

stripe unit size

The size of each stripe unit. The default stripe unit size is 64KB. The stripe unit size is sometimes also referred to as the *stripe width*.

striping

A layout technique that spreads data across several physical disks using stripes. The data is allocated alternately to the stripes within the subdisks of each plex.

subdisk

A consecutive set of contiguous disk blocks that form a logical disk segment. Subdisks can be associated with plexes to form volumes.



swap area

A disk region used to hold copies of memory pages swapped out by the system pager process.

swap volume

A VxVM volume that is configured for use as a swap area.

transaction

A set of configuration changes that succeed or fail as a group, rather than individually. Transactions are used internally to maintain consistent configurations.

volboot file

A small file that is used to locate copies of the [boot disk group](#) configuration. The file may list disks that contain configuration copies in standard locations, and can also contain direct pointers to configuration copy locations. The `volboot` file is stored in a system-dependent location.

VM disk

A disk that is both under VxVM control and assigned to a disk group. VM disks are sometimes referred to as VxVM disks or simply disks.

volume

A virtual disk, representing an addressable range of disk blocks used by applications such as file systems or databases. A volume is a collection of from one to 32 plexes.

volume configuration device

The volume configuration device (`/dev/vx/config`) is the interface through which all configuration changes to the volume device driver are performed.

volume device driver

The driver that forms the virtual disk drive between the application and the physical device driver level. The volume device driver is accessed through a virtual disk device node whose character device nodes appear in `/dev/vx/rdisk`, and whose block device nodes appear in `/dev/vx/dsk`.

volume event log

The device interface (`/dev/vx/event`) through which volume driver events are reported to utilities.



vxconfigd

The VxVM configuration daemon, which is responsible for making changes to the VxVM configuration. This daemon must be running before VxVM operations can be performed.

Index

Symbols

- /dev/vx/dmp directory 102
- /dev/vx/rdmp directory 102
- /etc/default/vxassist file 201, 339
- /etc/default/vxdg defaults file 352
- /etc/default/vxdg file 137
- /etc/default/vxdisk file 62, 77
- /etc/default/vxse file 385
- /etc/fstab file 250
- /etc/volboot file 173
- /etc/vx/darecs file 173
- /etc/vx/disk.info file 74
- /etc/vx/dmppolicy.info file 120
- /etc/vx/volboot file 145
- /sbin/init.d/vxvm-recover file 344

A

- A/A disk arrays 102
- A/P disk arrays 101
- A/P-C disk arrays 102
- A/PF disk arrays 102
- A/PF-C disk arrays 102
- A/PG disk arrays 101
- A/PG-C disk arrays 102
- access port 101
- activation modes for shared disk groups 351
- ACTIVE
 - plex state 185
 - volume state 225
- active path attribute 118
- Active/Active disk arrays 102
- Active/Passive disk arrays 101
- adaptive load-balancing 120
- adding disks 81
- alignment constraints 202
- APM
 - configuring 129
- application volumes 15
- array policy module (APM)
 - configuring 129
- array support library (ASL) 64
- ASL
 - array support library 64
- attributes
 - active 118
 - autogrow 281, 295
 - autogrowby 295
 - cache 280
 - cachesize 281
 - comment 182, 194
 - dcolen 51, 211, 308
 - dgalien_checking 202
 - displaying for rules 384
 - drl 212, 241
 - fastresync 211, 212, 253
 - for specifying storage 203
 - for Storage Expert 384
 - hasdcolog 253
 - highwatermark 295
 - init 221
 - len 182
 - listing for rules 383
 - loglen 213
 - logtype 213
 - maxautogrow 295
 - maxdev 149
 - name 182, 194
 - ncachemirror 281
 - ndcomirror 211, 212, 308
 - ndcomirs 235, 276
 - newvol 278
 - nmirror 278
 - nomannual 118
 - nopreferred 119
 - plex 194
 - preferred priority 119
 - primary 119



- putil 182, 194
- secondary 119
- sequential DRL 212
- setting for paths 118
- setting for rules 385
- snapvol 278
- source 278
- standby 119
- subdisk 182
- syncing 275, 292
- tutil 182, 194
- auto disk type 62
- autogrow
 - tuning 296
- autogrow attribute 281, 295
- autogrowby attribute 295
- autotrespass mode 101

B

- backups
 - created using snapshots 275
 - creating for volumes 261
 - creating using instant snapshots 275
 - creating using third-mirror snapshots 299
 - for multiple volumes 283, 303
 - implementing online 318
 - of disk group configuration 174
- balanced path policy 121
- base minor number 147
- blocks on disks 12
- boot disk group 133
- bootdg 133

C

- c# 4, 60
- c#t#d# 60
- c#t#d# based naming scheme 60
- cache attribute 280
- cache objects
 - creating 294
 - enabling 295
 - listing snapshots in 296
- caches
 - creating 294
 - deleting 298
 - finding out snapshots configured on 298
 - growing 297
 - listing snapshots in 296
 - removing 298

- resizing 297
- shrinking 297
- stopping 298
- used by space-optimized instant snapshots 267
- cache size attribute 281
- campus clusters
 - serial split brain condition in 150
- cascade instant snapshots 269
- cascaed snapshot hierarchies
 - creating 286
- categories
 - disks 64
- CDS
 - alignment constraints 202
 - compatible disk groups 137
 - disk format 62
- cds attribute 137
- cdsdisk format 62
- check_all policy 127
- check_alternate policy 127
- check_disabled policy 127
- check_periodic policy 127
- checkpoint interval 412
- CLEAN
 - plex state 185
 - volume state 225
- cluster functionality
 - enabling 452
 - shared disks 453
- cluster protocol version
 - checking 378
 - number 365
 - upgrading 378
- clusters
 - activating disk groups 352
 - activating shared disk groups 375
 - activation modes for shared disk groups 351
 - benefits 347
 - checking cluster protocol version 377
 - cluster protocol version number 365
 - cluster-shareable disk groups 350
 - configuration 358
 - configuring exclusive open of volume by node 376, 377
 - connectivity policies 353
 - converting shared disk groups to private 374

- creating shared disk groups 372
 - designating shareable disk groups 350
 - detach policies 353
 - determining if disks are shared 371
 - forcibly adding disks to disk groups 373
 - forcibly importing disk groups 373
 - importing disk groups as shared 373
 - initialization 358
 - introduced 348
 - joining disk groups in 375
 - limitations of shared disk groups 357
 - listing shared disk groups 371
 - maximum number of nodes in 347
 - moving objects between disk groups 374
 - node abort 365
 - node shutdown 364
 - nodes 348
 - operation of DRL in 366, 367
 - operation of vxconfigd in 362
 - operation of VxVM in 348
 - private disk groups 350
 - private networks 348
 - protection against simultaneous writes 351
 - reconfiguration of 358
 - resolving disk status in 353
 - setting disk connectivity policies in 376
 - setting failure policies in 376
 - shared disk groups 350
 - shared objects 351
 - splitting disk groups in 375
 - upgrading cluster protocol version 378
 - upgrading online 365
 - used of DMP in 105
 - vol_fmr_logsz tunable 413
 - volume reconfiguration 361
 - vxclustadm 359
 - vxctl 370
 - vxrecover 379
 - vxstat 379
 - cluster-shareable disk groups in clusters 350
 - columns
 - changing number of 257
 - checking number in volume 391
 - in striping 21
 - mirroring in striped-mirror volumes 215
 - comment
 - plex attribute 194
 - subdisk attribute 182
 - concatenated volumes 18, 196
 - concatenated-mirror volumes
 - converting to
 - mirrored-concatenated 260
 - creating 209
 - defined 28
 - recovery 197
 - concatenation 18
 - condition flags for plexes 188
 - configuration backup and restoration 174
 - configuration changes
 - monitoring using vxnotify 174
 - configuration copies for disk group 409
 - configuration database
 - checking number of copies 388
 - checking size of 388
 - copy size 132
 - in private region 61
 - reducing size of 155
 - configuring
 - shared disks 453
 - connectivity policies 353
 - setting for disk groups 376
 - controllers
 - checking for disabled 392
 - disabling for DMP 125
 - disabling in DMP 109, 125
 - mirroring across 207, 216
 - number 4
 - specifying to vxassist 203
 - controllers, mirroring guidelines 448
 - converting disks 71
 - copymaps 51
 - copy-on-write
 - used by instant snapshots 265
 - Cross-platform Data Sharing (CDS)
 - alignment constraints 202
 - disk format 62
 - CVM
 - cluster functionality of VxVM 347
- D**
- d# 4, 60
 - data change object
 - DCO 51
 - data redundancy 25, 26, 29
 - data volume configuration 44
 - database replay logs and sequential DRL 43
 - databases



-
- resilvering 44
 - resynchronizing 44
 - DCO
 - adding to RAID-5 volumes 237
 - adding version 0 DCOs to volumes 307
 - adding version 20 DCOs to volumes 235
 - calculating plex size for version 20 52
 - considerations for disk layout 161
 - creating volumes with version 0 DCOs
 - attached 210
 - creating volumes with version 20 DCOs
 - attached 212
 - data change object 51
 - determining version of 238
 - dissociating version 0 DCOs from volumes 310
 - effect on disk group split and join 161
 - log plexes 54
 - log volume 51
 - moving log plexes 237, 309
 - reattaching version 0 DCOs to volumes 310
 - removing version 0 DCOs from volumes 309
 - specifying storage for version 0 plexes 308
 - specifying storage for version 20 plexes 236
 - used with DRL 42
 - version 0 51
 - version 20 51
 - versioning 51
 - dcolen attribute 51, 211, 308
 - DCOSNP
 - plex state 185
 - DDL 6
 - Device Discovery Layer 66
 - decision support
 - implementing 322
 - default disk group 133
 - defaulttdg 133, 134
 - defaults
 - for vxdisk 62, 77
 - description file with vxmake 220
 - detach policy
 - global 354
 - local 354
 - DETACHED
 - plex kernel state 189
 - volume kernel state 227
 - device discovery
 - introduced 6
 - partial 63
 - Device Discovery Layer 66
 - Device Discovery Layer (DDL) 6, 66
 - device files to access volumes 222, 452
 - device names 4, 59
 - configuring persistent 74
 - devices
 - adding foreign 70
 - fabric 63
 - metadevices 59
 - pathname 59
 - dgalen_checking attribute 202
 - dgfailpolicy attribute 357
 - dirty bits in DRL 42
 - dirty flags set on volumes 41
 - dirty region logging. See DRL
 - dirty regions 415
 - disable failure policy 355
 - DISABLED
 - plex kernel state 189
 - volume kernel state 227
 - disabled paths 111
 - disk access records
 - stored in /etc/vx/darecs 173
 - disk arrays
 - A/A 102
 - A/P 101
 - A/P-C 102
 - A/PF 102
 - A/PF-C 102
 - A/PG 101
 - A/PG-C 102
 - Active/Active 102
 - Active/Passive 101
 - adding disks to DISKS category 68
 - adding vendor-supplied support package 64
 - defined 5
 - excluding support for 67
 - listing excluded 67
 - listing supported 66
 - listing supported disks in DISKS category 67
 - multipathed 6
 - re-including support for 67
 - removing disks from DISKS category 69



-
- removing vendor-supplied support package 65
 - disk drives
 - variable geometry 449
 - disk duplexing 25, 216
 - disk groups
 - activating shared 375
 - activation in clusters 352
 - adding disks to 138
 - avoiding conflicting minor numbers on import 147
 - boot disk group 133
 - bootdg 133
 - checking for non-imported 389
 - checking initialized disks 389
 - checking number of configuration copies in 389
 - checking number of configuration database copies 388
 - checking on disk config size 388
 - checking size of configuration database 388
 - checking version number 389
 - clearing locks on disks 145
 - cluster-shareable 350
 - compatible with CDS 137
 - configuration backup and restoration 174
 - converting to private 374
 - creating 137
 - creating shared 372
 - creating with old version number 172
 - default disk group 133
 - defaultdg 133
 - defaults file for shared 352
 - defined 11
 - deporting 139
 - designating as shareable 350
 - destroying 168
 - determining the default disk group 133
 - disabling 168
 - displaying boot disk group 134
 - displaying default disk group 134
 - displaying free space in 136
 - displaying information about 135
 - displaying version of 172
 - effect of size on private region 132
 - elimination of rootdg 131
 - failure policy 355
 - features supported by version 170
 - forcing import of 146
 - free space in 332
 - impact of number of configuration copies on performance 409
 - importing 141
 - importing as shared 373
 - importing forcibly 373
 - joining 158, 166
 - joining in clusters 375
 - layout of DCO plexes 161
 - limitations of move, split, and join 159
 - listing objects affected by a move 160
 - listing shared 371
 - moving between systems 144
 - moving disks between 144, 163
 - moving licensed EMC disks between 163
 - moving objects between 156, 163
 - moving objects in clusters 374
 - names reserved by system 133
 - nodg 133
 - number of spare disks 391
 - private in clusters 350
 - recovering destroyed 168
 - recovery from failed reconfiguration 159
 - removing disks from 138
 - renaming 142
 - reorganizing 155
 - reserving minor numbers 147
 - restarting moved volumes 164, 165, 167
 - root 11
 - rootdg 11, 131
 - serial split brain condition 150
 - setting connectivity policies in clusters 376
 - setting default disk group 134
 - setting failure policies in clusters 376
 - setting number of configuration copies 409
 - shared in clusters 350
 - specifying to commands 132
 - splitting 157, 165
 - splitting in clusters 375
 - Storage Expert rules 388
 - upgrading version of 169, 172
 - version 169, 171
 - disk media names 11, 59
 - disk names 59
 - configuring persistent 74



disk sparing
 Storage Expert rules 391

disk## 12

disk###-## 12

diskdetpolicy attribute 357

diskgroup## 59

disks 64

- adding 81
- adding to disk groups 138
- adding to disk groups forcibly 373
- adding to DISKS category 68
- array support library 64
- auto-configured 62
- categories 64
- CDS format 62
- changing default layout attributes 77
- changing naming scheme 72
- checking for failed 392
- checking initialized disks not in disk group 389
- checking number configuration copies in disk group 389
- checking proportion spare in disk group 391
- clearing locks on 145
- complete failure messages 332
- configuring newly added 63
- configuring persistent names 74
- converting 71
- default initialization values 77
- determining failed 331
- determining if shared 371
- Device Discovery Layer 66
- disabled path 111
- discovery of by VxVM 64
- disk access records file 173
- disk arrays 5
- displaying information 98, 99
- displaying information about 98, 135
- displaying spare 334
- enabled path 111
- enabling 95
- enclosures 6
- excluding free space from hot-relocation use 337
- failure handled by hot-relocation 328
- formatting 76
- hot-relocation 327
- HP format 62
- initializing 71, 77
- installing 76
- invoking discovery of 65
- layout of DCO plexes 161
- listing those supported in JBODs 67
- making available for hot-relocation 335
- making free space available for hot-relocation use 338
- marking as spare 335
- media name 59
- metadevices 59
- mirroring volumes on 232
- moving between disk groups 144, 163
- moving disk groups between systems 144
- moving volumes from 251
- names 59
- naming schemes 60
- nopriv 62
- number 4
- obtaining performance statistics 406
- OTHER_DISKS category 64
- OTHER_DISKS category 64
- partial failure messages 331
- postponing replacement 90
- primary path 111
- putting under control of VxVM 71
- reinitializing 81
- releasing from disk groups 168
- removing 87, 90
- removing from disk groups 138
- removing from DISKS category 69
- removing from pool of hot-relocation spares 336
- removing from VxVM control 89, 138
- removing with subdisks 88, 89
- renaming 97
- replacing 90
- replacing removed 93
- reserving for special purposes 98
- resolving status in clusters 353
- scanning for 63
- secondary path 111
- setting connectivity policies in clusters 376
- setting failure policies in clusters 376
- simple 62
- spare 332
- specifying to vxassist 203

- stripe unit size 449
- taking offline 96
- unreserving 98
- VM 11
- DISKS category 64
 - adding disks 68
 - listing supported disks 67
 - removing disks 69
- DMP
 - check_all restore policy 127
 - check_alternate restore policy 127
 - check_disabled restore policy 127
 - check_periodic restore policy 127
 - disabling controllers 125
 - disabling multipathing 106
 - displaying DMP database information 109
 - displaying DMP node for a path 112
 - displaying DMP node for an enclosure 112
 - displaying information about paths 110
 - displaying LUN group for a node 112
 - displaying paths controlled by DMP node 113
 - displaying status of DMP error daemons 128
 - displaying status of DMP restore daemon 128
 - displaying TPD information 115
 - dynamic multipathing 101
 - enabling multipathing 107
 - enclosure-based naming 103
 - gathering I/O statistics 116
 - in a clustered environment 105
 - listing controllers 114
 - listing enclosures 114
 - load balancing 104
 - metanodes 102
 - nodes 102
 - path failover mechanism 104
 - path-switch tunable 411
 - renaming an enclosure 126
 - restore policy 127
 - setting the DMP restore polling interval 127
 - starting the DMP restore daemon 127
 - stopping the DMP restore daemon 128
 - vxdmpadm 111
 - dmp_enable_restore_daemon tunable 411
 - dmp_failed_io_threshold tunable 411
 - dmp_pathswitch_blks_shift tunable 411
 - dmp_restore_daemon_cycles tunable 411
 - dmp_restore_daemon_interval tunable 411
 - dmp_restore_daemon_policy tunable 412
 - dmp_retry_count tunable 412
 - DRL
 - adding log subdisks 179
 - adding logs to mirrored volumes 242
 - checking existence of 387
 - checking existence of mirror 387
 - creating volumes with DRL enabled 212, 213
 - determining if active 239
 - determining if enabled 238
 - dirty bits 42
 - dirty region logging 42
 - disabling 239
 - enabling on volumes 235
 - handling recovery in clusters 367
 - hot-relocation limitations 329
 - log subdisks 43
 - maximum number of dirty regions 415
 - minimum number of sectors 415
 - operation in clusters 366
 - recovery map in version 20 DCO 52
 - re-enabling 239
 - removing logs from mirrored volumes 243
 - removing support for 239
 - sequential 43
 - use of DCO with 42
 - drl attribute 212, 241
 - DRL guidelines 448
 - duplexing 25, 216
- E**
 - EMC arrays
 - moving disks between disk groups 163
 - EMPTY
 - plex state 186
 - volume state 225
 - ENABLED
 - plex kernel state 189
 - volume kernel state 227
 - enabled paths, displaying 111
 - enclosure-based naming 6, 60, 72
 - displayed by vxprint 73
 - DMP 103



- enclosures 6
 - discovering disk access names in 73
 - issues with nopriv disks 75
 - issues with simple disks 75
 - mirroring across 216
 - setting attributes of paths 118
 - error messages
 - Association count is incorrect 369
 - Association not resolved 369
 - Cannot auto-import group 369
 - Configuration records are inconsistent 369
 - Disk for disk group not found 146
 - Disk group has no valid configuration copies 146, 369
 - Disk group version doesn't support feature 169
 - Disk is in use by another host 145
 - Disk is used by one or more subdisks 138
 - Disk not moving, but subdisks on it are 160
 - Duplicate record in configuration 369
 - import failed 145
 - No valid disk found containing disk group 145
 - tmpsize too small to perform this relayout 37
 - Volume has different organization in each mirror 246
 - vx dg listmove failed 160
 - exclusive-write mode 351
 - explicit failover mode 102
- F**
- fabric devices 63
 - failover 347, 348
 - failover mode 101
 - failure handled by hot-relocation 328
 - failure in RAID-5 handled by
 - hot-relocation 328
 - failure policies 355
 - setting for disk groups 376
 - FastResync
 - checking if enabled on volumes 253
 - disabling on volumes 254
 - effect of growing volume on 56
 - enabling on new volumes 211
 - enabling on volumes 252
 - limitations 57
 - Non-Persistent 50
 - operation with off-host processing 316
 - Persistent 50, 53
 - size of bitmap 412
 - snapshot enhancements 263
 - use with snapshots 49
 - fastresync attribute 211, 212, 253
 - file systems
 - growing using vxresize 246
 - shrinking using vxresize 246
 - unmounting 250
 - FMR. See FastResync
 - foreign devices
 - adding 70
 - formatting disks 76
 - free space in disk groups 332
 - full-sized instant snapshots 265
 - creating 278
 - creating volumes for use as 293
- G**
- GAB 358
 - global detach policy 354
 - Group Membership and Atomic Broadcast (GAB) 358
 - guidelines
 - DRL 448
 - mirroring 448
 - RAID-5 450
- H**
- hasdcolog attribute 253
 - HFS file systems
 - resizing 246
 - highwatermark attribute 295
 - hostnames
 - checking 392
 - hot_relocation
 - using only spare disks for 339
 - hot-relocation
 - complete failure messages 332
 - configuration summary 333
 - daemon 328
 - defined 58
 - detecting disk failure 328
 - detecting plex failure 328
 - detecting RAID-5 subdisk failure 328
 - excluding free space on disks from use by 337
 - limitations 329

- making free space on disks available for use by 338
- marking disks as spare 335
- modifying behavior of 344
- notifying users other than root 344
- operation of 327
- partial failure messages 331
- preventing from running 344
- reducing performance impact of recovery 345
- removing disks from spare pool 336
- Storage Expert rules 391
- subdisk relocation 333
- subdisk relocation messages 339
- unrelocating subdisks 339
- unrelocating subdisks using vxassist 341
- unrelocating subdisks using vxdiskadm 340
- unrelocating subdisks using vxunreloc 341
- use of free space in disk groups 332
- use of spare disks 332
- use of spare disks and free space 333
- vxrelocd 328
- HP disk format 62
- hpdisk format 62

I

- I/O
 - gathering statistics for DMP 116
 - use of statistics in performance tuning 405
 - using traces for performance tuning 408
- I/O operations
 - maximum number in parallel 414
 - maximum size of 413
- I/O policy
 - displaying 120
 - example 123
 - specifying 120
- identifiers for tasks 227
- implicit failover mode 101
- init attribute 221
- initialization
 - default attributes 77
 - of disks 71, 77
- initialization of disks 71
- instant snapshots
 - backing up multiple volumes 283

- cascaed 269
- creating backups 275
- creating for volume sets 284
- creating full-sized 278
- creating space-optimized 280
- creating volumes for use as full-sized 293
- displaying information about 291
- dissociating 289
- full-sized 265
- improving performance of synchronization 292
- reattaching 287
- refreshing 287
- removing 290
- removing support for 239
- restoring volumes using 288
- space-optimized 267
- splitting hierarchies 290
- synchronizing 292

Intelligent Storage Provisioning (ISP) 15

intent logging 261

INVALID volume state 226

ioctl calls 414

IOFAIL plex condition 188

IOFAIL plex state 186

ISP volumes 15

J

JBODs

- adding disks to DISKS category 68

- listing supported disks 67

- removing disks from DISKS category 69

K

kernel states

- for plexes 189

- volumes 227

L

layered volumes

- converting to non-layered 260

- defined 34, 196

- striped-mirror 26

layout attributes

- changing for disks 77

layouts

- changing default used by vxassist 203

- left-symmetric 31

- specifying default 203



- types of volume 196
- leave failure policy 355
- left-symmetric layout 31
- len subdisk attribute 182
- LIF area 82
- LIF LABEL record 82
- load balancing 102
 - across nodes in a cluster 348
 - displaying policy for 120
 - specifying policy for 120
- load-balancing
 - specifying policy for 120
- local detach policy 354
- lock clearing on disks 145
- LOG plex state 186
- log subdisks 448
 - associating with plexes 179
 - DRL 43
- logdisk 211, 217, 218
- logical units 101
- loglen attribute 213
- logs
 - adding DRL log 242
 - adding for RAID-5 243
 - adding sequential DRL logs 242
 - adding to volumes 234
 - checking for disabled 390
 - checking for multiple RAID-5 logs on same disk 386
 - RAID-5 33, 41
 - removing DRL log 243
 - removing for RAID-5 244
 - removing sequential DRL logs 243
 - resizing using vxvol 249
 - specifying number for RAID-5 217
 - usage with volumes 197
- logtype attribute 213
- LUN 101
- LUN group failover 101
- LUN groups
 - displaying details of 112

M

- maps
 - adding to volumes 234
 - usage with volumes 197
- master node
 - defined 349
 - discovering 370

- maxautogrow attribute 295
- maxdev attribute 149
- memory
 - granularity of allocation by VxVM 416
 - maximum size of pool for VxVM 416
 - minimum size of pool for VxVM 418
 - persistence of FastResync in 50
- messages
 - complete disk failure 332
 - hot-relocation of subdisks 339
 - partial disk failure 331
- metadevices 59
- metanodes
 - DMP 102
- minimum queue load balancing policy 122
- minor numbers 147
- mirrored volumes
 - adding DRL logs 242
 - adding sequential DRL logs 242
 - changing read policies for 249
 - checking existence of mirrored DRL 387
 - checking existence of without DRL 387
 - configuring VxVM to create by default 232
 - creating 209
 - creating across controllers 207, 216
 - creating across enclosures 216
 - creating across targets 205
 - defined 196
 - dirty region logging 42
 - DRL 42
 - FastResync 42
 - FR 42
 - logging 42
 - performance 400
 - removing DRL logs 243
 - removing sequential DRL logs 243
 - snapshots 49
- mirrored-concatenated volumes
 - converting to concatenated-mirror 260
 - creating 209
 - defined 26
- mirrored-stripe volumes
 - benefits of 25
 - checking configuration 390
 - converting to striped-mirror 260
 - creating 215
 - defined 196
 - performance 401



-
- mirroring
 - defined 25
 - guidelines 448
 - mirroring controllers 448
 - mirroring plus striping 26
 - mirrors
 - adding to volumes 231
 - boot disk 83
 - creating of VxVM root disk 84
 - creating snapshot 300
 - defined 16
 - removing from volumes 233
 - specifying number of 209
 - multipathing
 - disabling 106
 - displaying information about 110
 - enabling 107
 - Multi-Volume Support 311
- N**
- names
 - changing for disk groups 142
 - defining for snapshot volumes 303
 - device 4, 59
 - disk 59
 - disk media 11, 59
 - plex 14
 - plex attribute 194
 - renaming disks 97
 - subdisk 12
 - subdisk attribute 182
 - VM disk 12
 - volume 14
 - naming scheme
 - changing for disks 72
 - changing for TPD enclosures 72
 - for disk devices 60
 - ncachemirror attribute 281
 - ndcomirror attribute 211, 212, 308
 - ndcomirs attribute 235, 276
 - NEEDSYNC volume state 226
 - newvol attribute 278
 - nmirror attribute 278
 - NODAREC plex condition 188
 - nodes
 - DMP 102
 - in clusters 348
 - maximum number in a cluster 347
 - node abort in clusters 365
 - requesting status of 370
 - shutdown in clusters 364
 - use of vxclustadm to control cluster functionality 359
 - NODEVICE plex condition 188
 - nodg 133
 - nomannual path attribute 118
 - non-autotrespass mode 102
 - non-layered volume conversion 260
 - Non-Persistent FastResync 50
 - nopreferred path attribute 119
 - nopriv disk type 62
 - nopriv disks
 - issues with enclosures 75
- O**
- objects
 - physical 4
 - virtual 8
 - off-host processing 315, 347
 - OFFLINE plex state 186
 - online backups
 - implementing 318
 - online invalid status 99
 - online relayout
 - changing number of columns 257
 - changing region size 259
 - changing speed of 259
 - changing stripe unit size 257
 - combining with conversion 260
 - controlling progress of 259
 - defined 36
 - destination layouts 254
 - failure recovery 40
 - how it works 36
 - limitations 39
 - monitoring tasks for 258
 - pausing 259
 - performing 254
 - resuming 259
 - reversing direction of 259
 - specifying non-default 257
 - specifying plexes 258
 - specifying task tags for 258
 - temporary area 37
 - transformation characteristics 40
 - transformations and volume length 40
 - types of transformation 255
 - viewing status of 258



- online status 99
- ordered allocation 205, 211, 218
- OTHER_DISKS category 64
- overlapped seeks 448

P

- parity in RAID-5 29
- partial device discovery 63
- partition size
 - displaying the value of 120
 - specifying 121
- path failover in DMP 104
- pathgroups
 - creating 107
- paths
 - setting attributes of 118
- performance
 - analyzing data 405
 - benefits of using VxVM 399
 - changing values of tunables 410
 - combining mirroring and striping 401
 - effect of read policies 402
 - examining ratio of reads to writes 407
 - hot spots identified by I/O traces 408
 - impact of number of disk group configuration copies 409
 - improving for instant snapshot synchronization 292
 - load balancing in DMP 104
 - mirrored volumes 400
 - monitoring 403
 - moving volumes to improve 406
 - obtaining statistics for disks 406
 - obtaining statistics for volumes 404
 - RAID-5 volumes 401
 - setting priorities 403
 - striped volumes 400
 - striping to improve 407
 - tracing volume operations 403
 - tuning large systems 409
 - tuning VxVM 408
 - using I/O statistics 405
- persistent device name database 74
- persistent device naming 74
- Persistent FastResync 50, 51, 53
- physical disks
 - adding to disk groups 138
 - clearing locks on 145
 - complete failure messages 332

- determining failed 331
- displaying information 98
- displaying information about 98, 135
- displaying spare 334
- enabling 95
- excluding free space from hot-relocation use 337
- failure handled by hot-relocation 328
- initializing 71
- installing 76
- making available for hot-relocation 335
- making free space available for hot-relocation use 338
- marking as spare 335
- moving between disk groups 144, 163
- moving disk groups between systems 144
- moving volumes from 251
- partial failure messages 331
- postponing replacement 90
- releasing from disk groups 168
- removing 87, 90
- removing from disk groups 138
- removing from pool of hot-relocation spares 336
- removing with subdisks 88, 89
- replacing 90
- replacing removed 93
- reserving for special purposes 98
- spare 332
- taking offline 96
- unreserving 98
- physical objects 4
- ping-pong effect 105
- plex attribute 278
- plex conditions
 - IOFAIL 188
 - NODAREC 188
 - NODEVICE 188
 - RECOVER 188
 - REMOVED 188
- plex kernel states
 - DETACHED 189
 - DISABLED 189
 - ENABLED 189
- plex states
 - ACTIVE 185
 - CLEAN 185
 - DCOSNP 185



- EMPTY 186
 - IOFAIL 186
 - LOG 186
 - OFFLINE 186
 - SNAPATT 186
 - SNAPDIS 186
 - SNAPDONE 187
 - SNAPTMP 187
 - STALE 187
 - TEMP 187
 - TEMPRM 187
 - TEMPRMSD 188
 - plexes
 - adding to snapshots 305
 - associating log subdisks with 179
 - associating subdisks with 178
 - associating with volumes 189
 - attaching to volumes 189
 - changing attributes 194
 - changing read policies for 249
 - checking for detached 390
 - checking for disabled 390
 - comment attribute 194
 - complete failure messages 332
 - condition flags 188
 - converting to snapshot 302
 - copying 193
 - creating 183
 - creating striped 184
 - defined 14
 - detaching from volumes temporarily 191
 - disconnecting from volumes 190
 - displaying information about 184
 - dissociating from volumes 193
 - dissociating subdisks from 180
 - failure in hot-relocation 328
 - kernel states 189
 - limit on number per volume 402
 - maximum number of subdisks 415
 - maximum number per volume 15
 - mirrors 16
 - moving 192, 237, 309
 - name attribute 194
 - names 14
 - partial failure messages 331
 - putil attribute 194
 - putting online 191, 230
 - reattaching 191
 - recovering after correctable hardware failure 331
 - removing 193
 - removing from volumes 233
 - sparse 40, 178
 - specifying for online relayout 258
 - states 184
 - striped 21
 - taking offline 190, 230
 - tutil attribute 194
 - types 14
 - polling interval for DMP restore 127
 - preferred plex
 - performance of read policy 402
 - read policy 249
 - preferred priority path attribute 119
 - primary path 101, 111
 - primary path attribute 119
 - priority load balancing 122
 - private disk groups
 - converting from shared 374
 - in clusters 350
 - private network
 - in clusters 348
 - private region
 - checking size of configuration database 388
 - configuration database 61
 - defined 61
 - effect of large disk groups on 132
 - public region 62
 - putil
 - plex attribute 194
 - subdisk attribute 182
- R**
- RAID-0 21
 - RAID-0+1 25
 - RAID-1 25
 - RAID-1+0 26
 - RAID-5
 - adding logs 243
 - adding subdisks to plexes 179
 - checking existence of log 387
 - checking log is mirrored 388
 - checking size of log 387
 - guidelines 450
 - hot-relocation limitations 329
 - logs 33, 41



-
- parity 29
 - removing logs 244
 - specifying number of logs 217
 - subdisk failure handled by
 - hot-relocation 328
 - volumes 29
 - RAID-5 volumes
 - adding DCOs to 237
 - adding logs 243
 - changing number of columns 257
 - changing stripe unit size 257
 - checking existence of RAID-5 log 387
 - checking number of columns 391
 - checking RAID-5 log is mirrored 388
 - checking size of RAID-5 log 387
 - creating 217
 - defined 196
 - performance 401
 - removing logs 244
 - read policies
 - changing 249
 - performance of 402
 - prefer 249
 - round 249
 - select 249
 - read-only mode 351
 - RECOVER plex condition 188
 - recovery
 - checkpoint interval 412
 - I/O delay 412
 - preventing on restarting volumes 231
 - recovery accelerator 44
 - recovery time
 - Storage Expert rules 386
 - redo log configuration 45
 - redundancy
 - checking for volumes 389
 - of data on mirrors 196
 - of data on RAID-5 196
 - redundant-loop access 7
 - region 61
 - regionsize attribute 235, 276, 295
 - reinitialization of disks 81
 - relayout
 - changing number of columns 257
 - changing region size 259
 - changing speed of 259
 - changing stripe unit size 257
 - combining with conversion 260
 - controlling progress of 259
 - limitations 39
 - monitoring tasks for 258
 - online 36
 - pausing 259
 - performing online 254
 - resuming 259
 - reversing direction of 259
 - specifying non-default 257
 - specifying plexes 258
 - specifying task tags for 258
 - storage 36
 - transformation characteristics 40
 - types of transformation 255
 - viewing status of 258
 - relocation
 - automatic 327
 - complete failure messages 332
 - limitations 329
 - partial failure messages 331
 - REMOVED plex condition 188
 - removing disks 90
 - removing physical disks 87
 - replacing disks 90
 - replay logs and sequential DRL 43
 - REPLAY volume state 226
 - resilvering
 - databases 44
 - restoration of disk group configuration 174
 - restore policy
 - check_all 127
 - check_alterate 127
 - check_disabled 127
 - check_periodic 127
 - restrictions
 - VxVM-bootable volumes 82
 - resyncfromoriginal snapback 274
 - resyncfromreplica snapback 274
 - resynchronization
 - checkpoint interval 412
 - I/O delay 412
 - of volumes 41
 - resynchronizing
 - databases 44
 - root disk
 - creating mirrors 84
 - root disk group 11, 131
 - root disks
 - creating LVM from VxVM 85



- creating VxVM 84
 - removing LVM 85
- root mirrors
 - checking 392
- root volumes
 - booting 83
- rootability 82
 - checking 392
- rootdg 11
- round-robin
 - load balancing 122
 - performance of read policy 402
 - read policy 249
- rules
 - attributes 395
 - checking attribute values 384
 - checking disk group configuration copies 388
 - checking disk group version number 389
 - checking for full disk group configuration database 388
 - checking for initialized disks 389
 - checking for mirrored DRL 387
 - checking for multiple RAID-5 logs on a disk 386
 - checking for non-imported disk groups 389
 - checking for non-mirrored RAID-5 log 388
 - checking for RAID-5 log 387
 - checking hardware 392
 - checking hot-relocation 391
 - checking mirrored volumes without a DRL 387
 - checking mirrored-stripe volumes 390
 - checking number of configuration copies in disk group 389
 - checking number of RAID-5 columns 391
 - checking number of spare disks 391
 - checking number of stripe columns 391
 - checking on disk config size 388
 - checking plex and volume states 390
 - checking RAID-5 log size 387
 - checking rootability 392
 - checking stripe unit size 391
 - checking system name 392
 - checking volume redundancy 389
 - definitions 393

- finding information about 383
 - for checking hardware 392
 - for checking rootability 392
 - for checking system name 392
 - for disk groups 388
 - for disk sparing 391
 - for recovery time 386
 - for striped mirror volumes 390
 - listing attributes 383
 - result types 385
 - running 384
 - setting values of attributes 385

S

- scandisks
 - vxdisk subcommand 63
- secondary path 101
- secondary path attribute 119
- secondary path display 111
- sequential DRL
 - defined 43
 - maximum number of dirty regions 415
- sequential DRL attribute 212
- serial split brain condition
 - correcting 154
 - in campus clusters 150
 - in disk groups 150
- shared disk groups
 - activating 375
 - activation modes 351
 - converting to private 374
 - creating 372
 - importing 373
 - in clusters 350
 - limitations of 357
 - listing 371
- shared disks, configuring 453
- shared-read mode 351
- shared-write mode 351
- simple disk type 62
- simple disks
 - issues with enclosures 75
- single active path policy 123
- size units 175
- slave nodes
 - defined 349
- SmartSync 44
 - disabling on shared disk groups 415
 - enabling on shared disk groups 415



- snap objects 55
- snap volume naming 273
- snapabort 263
- SNAPATT plex state 186
- snapback
 - defined 264
 - merging snapshot volumes 304
 - resyncfromoriginal 274
 - resyncfromreplica 274, 304
- snapclear
 - creating independent volumes 305
- SNAPDIS plex state 186
- SNAPDONE plex state 187
- snapshot hierarchies
 - creating 286
 - splitting 290
- snapshot mirrors
 - adding to volumes 285
 - removing from volumes 286
- snapshots
 - adding mirrors to volumes 285
 - adding plexes to 305
 - and FastResync 49
 - backing up multiple volumes 283, 303
 - backing up volumes online using 275
 - cascaded 269
 - comparison of features 47
 - converting plexes to 302
 - creating a hierarchy of 286
 - creating backups using third-mirror 299
 - creating for volume sets 284
 - creating full-sized instant 278
 - creating independent volumes 305
 - creating instant 275
 - creating snapshots of 270
 - creating space-optimized instant 280
 - creating volumes for use as full-sized instant 293
 - defining names for 303
 - displaying information about 306
 - displaying information about instant 291
 - dissociating instant 289
 - emulation of third-mirror 268
 - finding out those configured on a cache 298
 - full-sized instant 47, 265
 - hierarchy of 269
 - improving performance of
 - synchronization 292
 - listing for a cache 296
 - merging with original volumes 304
 - of volumes 45
 - on multiple volumes 273
 - reattaching instant 287
 - refreshing instant 287
 - removing 302
 - removing instant 290
 - removing mirrors from volumes 286
 - restoring from instant 288
 - resynchronization on snapback 274
 - resynchronizing volumes from 304
 - space-optimized instant 47, 267
 - synchronizing instant 292
 - third-mirror 46
 - use of copy-on-write mechanism 265
- snapstart 263
- SNAPTMP plex state 187
- snapvol attribute 278
- source attribute 278
- space-optimized instant snapshots 267
 - creating 280
- spanned volumes 18
- spanning 18
- spare disks
 - checking proportion in disk group 391
 - displaying 334
 - marking disks as 335
 - used for hot-relocation 332
- sparse plexes 40, 178
- STALE plex state 187
- standby path attribute 119
- states
 - for plexes 184
 - volume 225
- storage
 - ordered allocation of 205, 211, 218
- storage attributes and volume layout 203
- storage cache
 - used by space-optimized instant snapshots 267
- Storage Expert
 - check keyword 384
 - checking default values of rule attributes 384
 - command-line syntax 382
 - diagnosing configuration issues 386
 - info keyword 383

-
- introduced 381
 - list keyword 383
 - listing rule attributes 383
 - obtaining a description of a rule 383
 - requirements 382
 - rule attributes 395
 - rule definitions 393
 - rule result types 385
 - rules 382
 - rules engine 382
 - run keyword 384
 - running a rule 384
 - setting values of rule attributes 385
 - vxse 381
 - storage processor 101
 - storage relayout 36
 - stripe columns 21
 - stripe unit size recommendations 449
 - stripe units
 - changing size 257
 - checking size 391
 - defined 21
 - striped plexes
 - adding subdisks 179
 - defined 21
 - striped volumes
 - changing number of columns 257
 - changing stripe unit size 257
 - checking number of columns 391
 - checking stripe unit size 391
 - creating 214
 - defined 196
 - failure of 21
 - performance 400
 - specifying non-default number of columns 214
 - specifying non-default stripe unit size 214
 - Storage Expert rules 390
 - striped-mirror volumes
 - benefits of 26
 - converting to mirrored-stripe 260
 - creating 215
 - defined 197
 - mirroring columns 215
 - mirroring subdisks 215
 - performance 401
 - trigger point for mirroring 215
 - stripe-mirror-col-split-trigger-pt 215
 - striping 21
 - striping guidelines 449
 - striping plus mirroring 25
 - subdisk names 12
 - subdisks
 - associating log subdisks 179
 - associating with plexes 178
 - associating with RAID-5 plexes 179
 - associating with striped plexes 179
 - blocks 12
 - changing attributes 182
 - comment attribute 182
 - complete failure messages 332
 - copying contents of 176
 - creating 175
 - defined 12
 - determining failed 331
 - displaying information about 176
 - dissociating from plexes 180
 - dividing 177
 - DRL log 431
 - hot-relocation 58, 327, 333
 - hot-relocation messages 339
 - joining 177
 - len attribute 182
 - listing original disks after hot-relocation 343
 - maximum number per plex 415
 - mirroring in striped-mirror volumes 215
 - moving after hot-relocation 339
 - moving contents of 176
 - name attribute 182
 - partial failure messages 331
 - physical disk placement 447
 - putil attribute 182
 - RAID-5 failure of 328
 - RAID-5 plex, configuring 450
 - removing from VxVM 180, 181
 - restrictions on moving 177
 - specifying different offsets for unrelocation 342
 - splitting 177
 - tutil attribute 182
 - unrelocating after hot-relocation 339
 - unrelocating to different disks 342
 - unrelocating using vxassist 341
 - unrelocating using vxdiskadm 340
 - unrelocating using vxunreloc 341
 - swap space



- increasing for VxVM rootable system 86
- SYNC volume state 226
- synchronization
 - controlling for instant snapshots 292
 - improving performance of 292
- syncing attribute 275, 292
- syncpause 292
- syncresume 292
- syncstart 292
- syncstop 292
- syncwait 292
- system names
 - checking 392

T

- t# 4, 60
- tags
 - for tasks 227
 - specifying for online relay layout tasks 258
 - specifying for tasks 227
- target IDs
 - number 4
 - specifying to vxassist 203
- target mirroring 205, 216
- task monitor in VxVM 227
- tasks
 - aborting 228
 - changing state of 228, 229
 - identifiers 227
 - listing 228
 - managing 228
 - modifying parameters of 229
 - monitoring 229
 - monitoring online relay layout 258
 - pausing 229
 - resuming 229
 - specifying tags 227
 - specifying tags on online relay layout operation 258
 - tags 227
- Technical assistance xxii
- TEMP plex state 187
- temporary area used by online relay layout 37
- TEMPRM plex state 187
- TEMPRMSD plex state 188
- third-mirror
 - snapshots 46
- third-party driver (TPD) 65
- TPD

- displaying path information 115
- support for coexistence 65
- tpdmode attribute 72
- trigger point in striped-mirror volumes 215
- tunables
 - changing values of 410
 - dmp_enable_restore_daemon 411
 - dmp_failed_io_threshold 411
 - dmp_pathswitch_blks_shift 411
 - dmp_restore_daemon_cycles 411
 - dmp_restore_daemon_interval 411
 - dmp_restore_daemon_policy 412
 - dmp_retry_count 412
 - vol_checkpt_default 412
 - vol_default_iodelay 412
 - vol_fmr_logsz 50, 412
 - vol_max_vol 413
 - vol_maxio 413
 - vol_maxioctl 414
 - vol_maxkiocount 414
 - vol_maxparallelio 414
 - vol_maxspecialio 414
 - vol_subdisk_num 415
 - volcvm_smartsync 415
 - voldrl_max_drtregs 415
 - voldrl_max_seq_dirty 43, 415
 - voldrl_min_regionsz 415
 - voliomem_chunk_size 416
 - voliomem_maxpool_sz 416
 - voliot_errbuf_dflt 416
 - voliot_iobuf_default 417
 - voliot_iobuf_limit 417
 - voliot_iobuf_max 417
 - voliot_max_open 417
 - volpagemod_max_memsz 418
 - volraid_minpool_size 418
 - volraid_rsrtransmax 418
- tutil
 - plex attribute 194
 - subdisk attribute 182

U

- units of size 175

V

- V-5-1-2536 246
- V-5-1-2829 169
- V-5-1-552 138
- V-5-1-569 369
- V-5-1-587 145



- V-5-2-3091 160
- V-5-2-369 139
- V-5-2-4292 160
- version 0
 - of DCOs 51
- version 20
 - of DCOs 51
- versioning
 - of DCOs 51
- versions
 - checking for disk group 389
 - disk group 169
 - displaying for disk group 172
 - upgrading 169
- virtual objects 8
- VM disks
 - defined 11
 - determining if shared 371
 - displaying spare 334
 - excluding free space from hot-relocation use 337
 - initializing 71
 - making free space available for hot-relocation use 338
 - marking as spare 335
 - mirroring volumes on 232
 - moving volumes from 251
 - names 12
 - postponing replacement 90
 - removing from pool of hot-relocation spares 336
 - renaming 97
- vol## 14
- vol###-## 14
- vol_checkpoint_default tunable 412
- vol_default_iodelay tunable 412
- vol_fmr_logsz tunable 50, 412
- vol_max_vol tunable 413
- vol_maxio tunable 413
- vol_maxioctl tunable 414
- vol_maxkiocount tunable 414
- vol_maxparallelio tunable 414
- vol_maxspecialio tunable 414
- vol_subdisk_num tunable 415
- volcvm_smartsync tunable 415
- voldr1_max_drtregs tunable 415
- voldr1_max_seq_dirty tunable 43, 415
- voldr1_min_regionsz tunable 415
- voliomem_chunk_size tunable 416
- voliomem_maxpool_sz tunable 416
- voliot_errbuf_dflt tunable 416
- voliot_iobuf_default tunable 417
- voliot_iobuf_limit tunable 417
- voliot_iobuf_max tunable 417
- voliot_max_open tunable 417
- volpagemod_max_memsz tunable 418
- volraid_minpool_size tunable 418
- volraid_rsrtransmax tunable 418
- volume kernel states
 - DETACHED 227
 - DISABLED 227
 - ENABLED 227
- volume length, RAID-5 guidelines 450
- volume resynchronization 41
- volume sets
 - adding volumes to 312
 - administering 311
 - creating 312
 - creating instant snapshots of 284
 - listing details of 313
 - removing volumes from 314
 - starting 313
 - stopping 313
- volume states
 - ACTIVE 225
 - CLEAN 225
 - EMPTY 225
 - INVALID 226
 - NEEDSYNC 226
 - REPLAY 226
 - SYNC 226
- volumes
 - accessing device files 222, 452
 - adding DRL logs 242
 - adding logs and maps to 234
 - adding mirrors 231
 - adding RAID-5 logs 243
 - adding sequential DRL logs 242
 - adding snapshot mirrors to 285
 - adding subdisks to plexes of 179
 - adding to volume sets 312
 - adding version 0 DCOs to 307
 - adding version 20 DCOs to 235
 - advanced approach to creating 198
 - assisted approach to creating 199
 - associating plexes with 189
 - attaching plexes to 189
 - backing up 261



backing up online using snapshots 275
block device files 222, 452
booting VxVM-rootable 83
changing layout online 254
changing number of columns 257
changing read policies for mirrored 249
changing stripe unit size 257
character device files 222, 452
checking for disabled 390
checking for stopped 390
checking if FastResync is enabled 253
checking redundancy of 389
combining mirroring and striping for performance 401
combining online relayout and conversion 260
concatenated 18, 196
concatenated-mirror 28, 197
configuring exclusive open by cluster node 376, 377
converting between layered and non-layered 260
converting concatenated-mirror to mirrored-concatenated 260
converting mirrored-concatenated to concatenated-mirror 260
converting mirrored-stripe to striped-mirror 260
converting striped-mirror to mirrored-stripe 260
creating 198
creating concatenated-mirror 209
creating for use as full-sized instant snapshots 293
creating from snapshots 305
creating mirrored 209
creating mirrored-concatenated 209
creating mirrored-stripe 215
creating RAID-5 217
creating snapshots 301
creating striped 214
creating striped-mirror 215
creating using vxmake 218
creating using vxmake description file 220
creating with version 0 DCOs attached 210
creating with version 20 DCOs attached 212
defined 14
detaching plexes from temporarily 191
disabling FastResync 254
disconnecting plexes 190
displaying information 224
displaying information about snapshots 306
dissociating plexes from 193
dissociating version 0 DCOs from 310 DRL 448
effect of growing on FastResync maps 56
enabling FastResync on 252
enabling FastResync on new 211
excluding storage from use by vxassist 204
finding maximum size of 202
finding out maximum possible growth of 245
flagged as dirty 41
initializing contents to zero 222
initializing using vxassist 221
initializing using vxvol 222
kernel states 227
layered 26, 34, 196
limit on number of plexes 15
limitations 15
making immediately available for use 221
maximum number of 413
maximum number of data plexes 402
merging snapshots 304
mirrored 25, 196
mirrored-concatenated 26
mirrored-stripe 25, 196
mirroring across controllers 207, 216
mirroring across targets 205, 216
mirroring all 232
mirroring on disks 232
mirroring VxVM-rootable 83
moving from VM disks 251
moving to improve performance 406
names 14
naming snap 273
obtaining performance statistics 404
performance of mirrored 400
performance of RAID-5 401
performance of striped 400
performing online relayout 254
placing in maintenance mode 230

- preparing for DRL and instant snapshot operations 235
- preventing recovery on restarting 231
- RAID-0 21
- RAID-0+1 25
- RAID-1 25
- RAID-1+0 26
- RAID-10 26
- RAID-5 29, 196
- raw device files 222, 452
- reattaching plexes 191
- reattaching version 0 DCOs to 310
- reconfiguration in clusters 361
- recovering after correctable hardware failure 331
- removing 250
- removing DRL logs 243
- removing from /etc/fstab 250
- removing mirrors from 233
- removing plexes from 233
- removing RAID-5 logs 244
- removing sequential DRL logs 243
- removing snapshot mirrors from 286
- removing support for DRL and instant snapshots 239
- removing version 0 DCOs from 309
- resizing 245
- resizing using vxassist 247
- resizing using vxresize 246
- resizing using vxvol 248
- restarting moved 164, 165, 167
- restoring from instant snapshots 288
- restrictions on VxVM-bootable 82
- resynchronizing from snapshots 304
- snapshots 45
- spanned 18
- specifying default layout 203
- specifying non-default number of columns 214
- specifying non-default relay layout 257
- specifying non-default stripe unit size 214
- specifying storage for version 0 DCO plexes 308
- specifying storage for version 20 DCO plexes 236
- specifying use of storage to vxassist 203
- starting 231
- starting using vxassist 221
- starting using vxvol 222
- states 225
- stopping 230
- stopping activity on 250
- striped 21, 196
- striped-mirror 26, 197
- striping to improve performance 407
- taking multiple snapshots 273
- tracing operations 403
- trigger point for mirroring in striped-mirror 215
- types of layout 196
- upgrading to use new features 240
- using logs and maps with 197
- zeroing out contents of 221
- vxassist
 - adding a log subdisk 180
 - adding a RAID-5 log 243
 - adding DCOs to volumes 308
 - adding DRL logs 242
 - adding mirrors to volumes 190, 231
 - adding sequential DRL logs 242
 - advantages of using 199
 - changing number of columns 257
 - changing stripe unit size 257
 - command usage 200
 - configuring exclusive access to a volume 376
 - converting between layered and non-layered volumes 260
 - creating cache volumes 295
 - creating concatenated-mirror volumes 209
 - creating mirrored volumes 209
 - creating mirrored-concatenated volumes 209
 - creating mirrored-stripe volumes 215
 - creating RAID-5 volumes 217
 - creating snapshots 299
 - creating striped volumes 214
 - creating striped-mirror volumes 215
 - creating volumes 199
 - creating volumes for use as full-sized instant snapshots 294
 - creating volumes with DRL enabled 213
 - creating volumes with version 0 DCOs attached 211
 - creating volumes with version 20 DCOs attached 212



- defaults file 201
- defining layout on specified storage 203
- discovering maximum volume size 202
- displaying information about snapshots 306
- dissociating snapshots from volumes 305
- excluding storage from use 204
- finding out how much volumes can grow 245
- merging snapshots with volumes 304
- mirroring across controllers 207, 216
- mirroring across enclosures 216
- mirroring across targets 205, 207
- moving DCO log plexes 237
- moving DCO plexes 309
- moving subdisks after hot-relocation 341
- moving volumes 406
- relaying out volumes online 254
- removing DCOs from volumes 241
- removing DRL logs 243
- removing mirrors 233
- removing plexes 233
- removing RAID-5 logs 244
- removing version 0 DCOs from volumes 309
- removing volumes 250
- reserving disks 98
- resizing volumes 247
- resynchronizing volumes from snapshots 304
- setting default values 201
- snapabort 263
- snapback 264
- snapshot 263
- snapstart 263
- specifying number of mirrors 209
- specifying number of RAID-5 logs 217
- specifying ordered allocation of storage 205
- specifying plexes for online relayout 258
- specifying storage attributes 203
- specifying storage for version 0 DCO plexes 308
- specifying tags for online relayout tasks 258
- taking snapshots of multiple volumes 303
- unrelocating subdisks after hot-relocation 341
- vxcache
 - listing snapshots in a cache 296
 - resizing caches 297
 - starting cache objects 295
 - stopping a cache 298
 - tuning cache autogrow 297
- vxcached
 - tuning 296
- vxclustadm 359
- vxconfigd
 - managing with vxdctl 173
 - monitoring configuration changes 174
 - operation in clusters 362
- vxcp_lvm_root
 - used to create VxVM root disk 84
 - used to create VxVM root disk mirrors 84
- vxdarestore
 - used to handle simple/nopriv disk failures 75
- vxdc
 - dissociating version 0 DCOs from volumes 310
 - reattaching version 0 DCOs to volumes 310
 - removing version 0 DCOs from volumes 309
- vxdctl
 - checking cluster protocol version 377
 - managing vxconfigd 173
 - setting default disk group 134
 - upgrading cluster protocol version 378
 - usage in clusters 370
- vxdctl enable
 - configuring new disks 63
 - invoking device discovery 65
 - used to configure new disks 63
- vxddladm
 - adding disks to DISKS category 68
 - adding foreign devices 70
 - changing naming scheme 72
 - listing excluded disk arrays 67
 - listing supported disk arrays 66
 - listing supported disks in DISKS category 67
 - removing disks from DISKS category 69, 70

- used to exclude support for disk arrays 67
- used to re-include support for disk arrays 67
- vxdestroy_lvmroot
 - used to remove LVM root disks 85
- vxchg
 - adding disks to disk groups forcibly 373
 - changing activation mode on shared disk groups 375
 - clearing locks on disks 145
 - controlling CDS compatibility of new disk groups 137
 - converting shared disk groups to private 374
 - correcting serial split brain condition 155
 - creating disk groups 137
 - creating disk groups with old version number 172
 - creating shared disk groups 372
 - deporting disk groups 141
 - destroying disk groups 168
 - disabling a disk group 168
 - displaying boot disk group 134
 - displaying default disk group 134
 - displaying disk group version 172
 - displaying free space in disk groups 136
 - displaying information about disk groups 135
 - forcing import of disk groups 146
 - importing disk groups 142
 - importing shared disk groups 373
 - joining disk groups 166
 - listing objects affected by move 160
 - listing shared disk groups 371
 - listing spare disks 334
 - moving disk groups between systems 144
 - moving disks between disk groups 144
 - moving objects between disk groups 163
 - obtaining copy size of configuration database 132
 - recovering destroyed disk groups 168
 - removing disks from disk groups 138
 - renaming disk groups 142
 - setting base minor number 147
 - setting disk connectivity policy in a cluster 376
 - setting disk group policies 357
 - setting failure policy in a cluster 376
 - setting maximum number of devices 149
 - splitting disk groups 165
 - upgrading disk group version 172
- vxdisk
 - clearing locks on disks 145
 - defaults file 62, 77
 - determining if disks are shared 371
 - discovering disk access names 73
 - displaying information about disks 135
 - displaying multipathing information 110
 - listing disks 98
 - listing spare disks 334
 - scanning disk devices 63
- vxdisk scandisks
 - rescanning devices 63
 - scanning devices 63
- vxdiskadd
 - adding disks to disk groups 138
 - creating disk groups 137
 - placing disks under VxVM control 81
- vxdiskadm
 - Add or initialize one or more disks 77, 137
 - adding disks 77
 - adding disks to disk groups 138
 - Change/display the default disk layout 77
 - changing disk-naming scheme 72
 - changing the disk-naming scheme 72
 - creating disk groups 137
 - deporting disk groups 139
 - Disable (offline) a disk device 96
 - Enable (online) a disk device 95
 - Enable access to (import) a disk group 141
 - Exclude a disk from hot-relocation use 337
 - excluding free space on disks from hot-relocation use 337
 - importing disk groups 141
 - initializing disks 77
 - List disk information 99
 - listing spare disks 334
 - Make a disk available for hot-relocation use 338
 - making free space on disks available for hot-relocation use 338



-
- Mark a disk as a spare for a disk group 335
 - marking disks as spare 335
 - Mirror volumes on a disk 232
 - mirroring volumes 232
 - Move volumes from a disk 251
 - moving disk groups between systems 146
 - moving disks between disk groups 144
 - moving subdisks after hot-relocation 340
 - moving subdisks from disks 139
 - moving volumes from VM disks 251
 - Remove a disk 87, 139
 - Remove a disk for replacement 90
 - Remove access to (deport) a disk group 139
 - removing disks from pool of hot-relocation spares 336
 - Replace a failed or removed disk 93
 - Turn off the spare flag on a disk 336
 - Unrelocate subdisks back to a disk 340
 - unrelocating subdisks after hot-relocation 340
 - vxdiskunsetup
 - removing disks from VxVM control 89, 138
 - vxdkmpadm
 - changing TPD naming scheme 72
 - disabling controllers 126
 - disabling controllers in DMP 109, 125
 - discovering disk access names 73
 - displaying DMP database information 109
 - displaying DMP node for a path 112
 - displaying DMP node for an enclosure 112
 - displaying I/O policy 120
 - displaying partition size 120
 - displaying paths controlled by DMP node 113
 - displaying status of DMP error daemons 128
 - displaying status of DMP restore daemon 128
 - displaying TPD information 115
 - gathering I/O statistics 116
 - listing controllers 114
 - listing enclosures 114
 - renaming enclosures 126
 - setting I/O policy 122, 123
 - setting path attributes 119
 - setting restore polling interval 127
 - specifying DMP restore policy 127
 - starting DMP restore daemon 127
 - stopping DMP restore daemon 128
 - vxedit
 - changing plex attributes 194
 - changing subdisk attributes 182
 - configuring number of configuration copies for a disk group 410
 - excluding free space on disks from hot-relocation use 337
 - making free space on disks available for hot-relocation use 338
 - marking disks as spare 335
 - removing a cache 298
 - removing disks from pool of hot-relocation spares 336
 - removing instant snapshots 290
 - removing plexes 194
 - removing snapshots from a cache 298
 - removing subdisks from VxVM 181
 - removing volumes 250
 - renaming disks 97
 - reserving disks 98
 - VxFS file system resizing 246
 - vxmake
 - associating plexes with volumes 189
 - associating subdisks with new plexes 178
 - creating cache objects 295
 - creating plexes 183, 231
 - creating striped plexes 184
 - creating subdisks 175
 - creating volumes 218
 - using description file with 220
 - vxmend
 - putting plexes online 230
 - re-enabling plexes 191
 - taking plexes offline 190, 230
 - vxmirror
 - configuring VxVM default behavior 232
 - mirroring volumes 232
 - vxnotify
 - monitoring configuration changes 174
 - vxplex
 - adding RAID-5 logs 244

-
- attaching plexes to volumes 189, 231
 - converting plexes to snapshots 302
 - copying plexes 193
 - detaching plexes temporarily 191
 - dissociating and removing plexes 193
 - dissociating plexes from volumes 194
 - moving plexes 192
 - reattaching plexes 191
 - removing mirrors 233
 - removing plexes 233
 - removing RAID-5 logs 244
 - vxprint
 - checking if FastResync is enabled 253
 - determining if DRL is enabled 238
 - displaying DCO information 236, 309
 - displaying plex information 184
 - displaying snapshots configured on a cache 298
 - displaying subdisk information 176
 - displaying volume information 224
 - enclosure-based disk names 73
 - identifying RAID-5 log plexes 244
 - listing spare disks 334
 - used with enclosure-based disk names 73
 - verifying if volumes are prepared for instant snapshots 276
 - viewing base minor number 147
 - vxrecover
 - preventing recovery 231
 - recovering plexes 331
 - restarting moved volumes 164, 165, 167
 - restarting volumes 231
 - vxrelayout
 - resuming online relayout 259
 - reversing direction of online relayout 259
 - viewing status of online relayout 258
 - vxrelocd
 - hot-relocation daemon 328
 - modifying behavior of 344
 - notifying users other than root 344
 - operation of 329
 - preventing from running 344
 - reducing performance impact of recovery 345
 - vxres_lvmroot
 - used to create LVM root disks 85
 - vxresize
 - growing volumes and file systems 246
 - limitations 246
 - shrinking volumes and file systems 246
 - vxrootmir
 - used to create VxVM root disk mirrors 84
 - vxsd
 - adding log subdisks 180
 - adding subdisks to RAID-5 plexes 179
 - adding subdisks to striped plexes 179
 - associating subdisks with existing plexes 178
 - dissociating subdisks 180
 - filling in sparse plexes 179
 - joining subdisks 177
 - moving subdisk contents 176
 - removing subdisks from VxVM 180
 - splitting subdisks 177
 - vxse
 - Storage Expert 381
 - vxse_dc_failures
 - rule to check for hardware failures 392
 - vxse_dg1
 - rule to check for full disk group configuration database 388
 - vxse_dg2
 - rule to check disk group configuration copies 388
 - vxse_dg3
 - rule to check on disk config size 388
 - vxse_dg4
 - rule to check disk group version number 389
 - vxse_dg5
 - rule to check number of configuration copies in disk group 389
 - vxse_dg6
 - rule to check for non-imported disk groups 389
 - vxse_disk
 - rule to check for initialized disks 389
 - vxse_disklog
 - rule to check for multiple RAID-5 logs on a disk 386
 - vxse_drl1
 - rule to check for mirrored volumes without a DRL 387
 - vxse_drl2
 - rule to check for mirrored DRL 387



-
- vxse_host
 - rule to check system name 392
 - vxse_mirstripe
 - rule to check mirrored-stripe volumes 390
 - vxse_raid5
 - rule to check number of RAID-5 columns 391
 - vxse_raid5log1
 - rule to check for RAID-5 log 387
 - vxse_raid5log2
 - rule to check RAID-5 log size 387
 - vxse_raid5log3
 - rule to check for non-mirrored RAID-5 log 388
 - vxse_redundancy
 - rule to check volume redundancy 389
 - vxse_rootmir
 - rule to check rootability 392
 - vxse_spare
 - rule to check number of spare disks 391
 - vxse_stripes1
 - rule to check stripe unit size 391
 - vxse_stripes2
 - rule to check number of stripe columns 391
 - vxse_volplex
 - rule to check plex and volume states 390
 - vxsnap
 - adding snapshot mirrors to volumes 278, 285
 - administering instant snapshots 265
 - backing up multiple volumes 283
 - controlling instant snapshot synchronization 292
 - creating a cascaded snapshot hierarchy 286
 - creating full-sized instant snapshots 278
 - creating space-optimized instant snapshots 280
 - displaying information about instant snapshots 291
 - dissociating instant snapshots 289
 - preparing volumes for DRL and instant snapshots operations 235
 - preparing volumes for instant snapshots 276
 - reattaching instant snapshots 287
 - refreshing instant snapshots 287
 - removing a snapshot mirror from a volume 286
 - removing support for DRL and instant snapshots 239
 - restore 266
 - restoring volumes 288
 - splitting snapshot hierarchies 290
 - vxsplitlines
 - diagnosing serial split brain condition 154
 - vxstat
 - determining which disks have failed 331
 - obtaining disk performance statistics 406
 - obtaining volume performance statistics 404
 - usage with clusters 379
 - zeroing counters 405
 - vxtask
 - aborting tasks 229
 - listing tasks 229
 - monitoring online relayout 258
 - monitoring tasks 229
 - pausing online relayout 259
 - resuming online relayout 259
 - resuming tasks 229
 - vxtrace
 - tracing volume operations 403
 - vxtune
 - setting volpagemod_max_memsz 418
 - vxunreloc
 - listing original disks of hot-relocated subdisks 343
 - moving subdisks after hot-relocation 341
 - restarting after errors 343
 - specifying different offsets for unrelocated subdisks 342
 - unrelocating subdisks after hot-relocation 341
 - unrelocating subdisks to different disks 342
 - VxVM
 - benefits to performance 399
 - cluster functionality (CVM) 347
 - configuration daemon 173
 - configuring disk devices 63
 - configuring to create mirrored volumes 232

-
- dependency on operating system 3
 - disk discovery 64
 - granularity of memory allocation by 416
 - limitations of shared disk groups 357
 - maximum number of data plexes per volume 402
 - maximum number of subdisks per plex 415
 - maximum number of volumes 413
 - maximum size of memory pool 416
 - minimum size of memory pool 418
 - objects in 8
 - operation in clusters 348
 - performance tuning 408
 - removing disks from 138
 - removing disks from control of 89
 - shared objects in cluster 351
 - size units 175
 - task monitor 227
 - types of volume layout 196
 - upgrading 169
 - upgrading disk group version 172
 - VXVM_DEFAULTDG environment variable 133
 - vxvmdmpadm
 - configuring an APM 129
 - displaying APM information 129
 - removing an APM 129
 - VxVM-rootable volumes
 - mirroring 83
 - vxvol
 - configuring exclusive access to a volume 377
 - disabling DRL 239
 - disabling FastResync 254
 - enabling FastResync 253
 - initializing volumes 222
 - putting volumes in maintenance mode 230
 - re-enabling DRL 239
 - resizing logs 249
 - resizing volumes 248
 - restarting moved volumes 164, 165, 167
 - setting read policy 249
 - starting volumes 222, 231
 - stopping volumes 230, 250
 - zeroing out volumes 222
 - vxvset
 - adding volumes to volume sets 312
 - creating volume sets 312
 - listing details of volume sets 313
 - removing volumes from volume sets 314
 - starting volume sets 313
 - stopping volume sets 313
- W**
- warning messages
 - Specified region-size is larger than the limit on the system 277
 - worldwide name identifiers 60, 72
 - WWN identifiers 60, 72
- Z**
- zero
 - setting volume contents to 221

