

I/O Expansion Cabinet Guide

For Superdome Servers

Third Edition



Manufacturing Part Number: n A5201-10018

August 2001

USA

Released

August 2001

Legal Notices

The information in this document is subject to change without notice.

Hewlett-Packard makes no warranty of any kind with regard to this manual, including, but not limited to, the implied warranties of merchantability and fitness for a particular purpose. Hewlett-Packard shall not be held liable for errors contained herein or direct, indirect, special, incidental or consequential damages in connection with the furnishing, performance, or use of this material.

Restricted Rights Legend. Use, duplication or disclosure by the U.S. Government is subject to restrictions as set forth in subparagraph (c) (1) (ii) of the Rights in Technical Data and Computer Software clause at DFARS 252.227-7013 for DOD agencies, and subparagraphs (c) (1) and (c) (2) of the Commercial Computer Software Restricted Rights clause at FAR 52.227-19 for other agencies.

HEWLETT-PACKARD COMPANY 3000 Hanover Street Palo Alto, California 94304 U.S.A.

Copyright Notices. ©copyright 1983-2001 Hewlett-Packard Company, all rights reserved.

Reproduction, adaptation, or translation of this document without prior written permission is prohibited, except as allowed under the copyright laws.

Trademark Notices UNIX is a registered trademark in the United States and other countries, licensed exclusively through X/Open Company Limited.

1. Introduction

Overview	2
Cabinet layout	3
ICE	4
XUC	6
XPC	7
IOX Visual Indicators	13
ICE Visual Indicators	13
XPC visual Indicators	15
Front and Rear Displays	16
Cabinet Description	18
Anti-Tip Stabilizer Feet	19
Heavy-Duty Casters	19
Leveling Feet	20
Rear Door	21
System Configurations	22
Peripheral Support	23
Loading the Cabinet	25
Component Numbering	27

2. Upgrading the Superdome for IOX

Removing Old Side Skins	31
Installing New Cable Exit Panel	36
Installing the New Side Skins	38
Finishing the Upgrade	40

3. Installing the IOX

Unpacking the IOX	42
Moving the IOX into Position	48
Aligning the IOX Cabinet to the Superdome Cabinet	51
Securing the Cabinet	56
Connecting the IOX to the Superdome	58
Grounding the IOX to the Superdome	58
Connecting the REO and GSP Bus Cables	59
Setting the Cabinet Number	74

4. Cabling

Cable Management	78
----------------------------	----

Contents

Routing the Cables	79
Routing the ICE Cables	79
Routing the XUC Cables	83
XPC Cable Routing	85

5. Adding an ICE to the IOX

Preliminary Installation	88
Installing Equipment Rails	89
Mounting the ICE into the Rack	91
Installing the ICE Components	93
Connecting the Cables	95
Connecting the REO Cables to ICE Backplane.	97
Connecting the REO Cables to the Superdome Server.	99
Connecting the XUC-to-ICE Clock Cable	101
Connecting the Utilities Cable.	107
Connecting the Fan Control Cable.	109
Connecting the ICE DC Power Cable	110
Completing the Upgrade	112
Securing the ICE.	117

6. Remove and Replace Procedures

Removing the ICE	120
Required Tools.	120
Removing Panels and Extending the ICE.	120
Removing the Cables	123
Removing the ICE.	126
Replacing the ICE	129
Connecting the Cables	129
Re-installing the Fan shield.	130
Removing and Replacing the ICE I/O chassis	132
Removing the I/O chassis	132
Replacing the I/O Chassis	134
Removing and Replacing the ICE Fan Module.	135
Required Tools.	135
Removing the ICE Fan	135
Replacing the Fan Module	136

Removing and Replacing the ICE XMIOB	137
Removing the XMOIB.	137
Replacing the XMIOB.	140
Removing and Replacing the XUC	141
Required Tools.	141
Removing the XUC	141
Replacing the XUC	143
Removing and Replacing the XUC Fan Module	145
Required Tools.	145
Replacing the Fan Module	145
Replacing the XUC Fan Module.	147
Removing and Replacing the PM/CLU (UGUY).	148
Required Tools.	148
Removing the PM/CLU.	148
Replacing the PM/CLU.	150
Replacing the SBCHL (Lite)	151
Removing and Replacing the XPC	152
Required Tools.	152
Removing a XPC	152
Replacing the XPC	153
Removing and Replacing the BPS.	154
Required Tools.	154
Removing a BPS	154
Replacing the BPS	154

7. Testing the IOX

Checking I/O Expansion Cabinet Status	156
Tools for Listing I/O Expansion Cabinet Status	156
Table of Procedures.	158
Listing Power and Fan Status for I/O Expansion Cabinets	159
Listing Chassis or PCI Slot Populations for I/O Expansion Cabinets	162
Listing Cell and Partition Connections for I/O Expansion Cabinets	165

A. System Specifications

Dimensions and Weights	168
Cabinet Dimensions	168
ICE Dimensions and Weight	168
XUC Dimension and Weight	169

Contents

XPC	170
IOX Cabinet Weight	171
Electrical Specifications	175
AC Power Requirements	175
XPC	175
DC Power Requirements	176
Environmental Requirements	177
Temperature and Humidity Specifications	177
Cabinet Power Dissipation	177

B. Site Requirements

Space Requirements	180
Delivery Space Requirements	180
Required Foot Print and Service Access Space	180
Alignment with SuperDome Cabinet	180
Operational Space Requirements	181
Power Requirements	182
Computer Room Safety	182
Electrical Load Requirements (Circuit Breaker Sizing)	182
Power Quality	183
Distribution Hardware	183
Grounding Systems	184
System Installation Guidelines	185
Facility Characteristics	187
Floor Loading	187
Altitude Effects	188
Safety Considerations	190
Communications Interference	190
Electrostatic Discharge	190
Environmental Requirements	191
Computer Room Preparation	191
Cooling Requirements	191
Humidity Level	197
Air Conditioning Ducts	198
Dust and Pollution Control	198
Electrostatic Discharge (ESD) Prevention	198

Acoustics 199

C. Terms and Acronyms

Contents

Preface

Revision History

Table 1 **Revisions**

Revision	Part Number	Release Date	Description
Third	A5201-10018	August 2001	Update Safety and Regulatory information.
Second	A5201-10015	July 2001	Added Safety and Regulatory section. Added general updates and corrections.

Safety and Regulatory Information



For your protection, this product has been tested to various national and international regulations and standards. The scope of this regulatory testing includes electrical/mechanical safety, radio frequency interference, acoustics, and know hazardous materials. Where applicable, approvals obtained from third-party test agencies are shown on the product label.

Notational Conventions

WARNING **Warnings highlight procedures or information necessary to avoid injury to personnel. The warning should tell the reader exactly what will result from what actions and how to avoid them.**

CAUTION A caution highlights procedures or information necessary to avoid damage to equipment, damage to software, loss of data, or invalid test results.

NOTE A note highlights supplemental information.

Safety in Material Handling

WARNING Do not lift the cabinet manually. To avoid physical injury you must use a mechanical lifting device.

WARNING Do not attempt to move the Superdome cabinet, either packed or unpacked, up or down an incline of more than 15°.

WARNING Use care when working with hazardous voltages. This equipment may be configured with dual input line sources. Hazardous voltages and energy maybe present even after the removal of a single input source. Trained service personnel must follow the service guidelines.

WARNING Do not stand in front of the equipment as it is rolled off the pallet onto the ramps. When removing the equipment from the shipping pallet, follow the guidelines specified in the See “Moving the IOX into Position” on page 48.

WARNING Attach stabilizer feet to both front and back before extending the equipment drawers. Failure to attach the stabilizer feet may result in a tip hazard.

WARNING Observe pinch hazard areas. Keep fingers away from closing parts.

USA Radio Frequency Interference FCC Notice

The Federal Communications Commission (in 47 CFR Part 15 subpart B) has specified that the following notice be brought to the attention of the users of this product.

NOTE This equipment has been tested and found to comply with the limits for a Class A digital device, pursuant to Part 15 of the FCC Rules. These limits are designed to provide reasonable protection against harmful interference when the equipment is operated in a commercial environment. This equipment generates, uses, and can radiate radio frequency energy and, if not installed and used in accordance with the instruction manual, may cause harmful interference to radio communications. Operation of this equipment in a residential area is likely to cause harmful interference in which case the user will be required to correct the interference at his own expense.

The user is cautioned that changes or modifications not expressly approved by Hewlett-Packard could result in the equipment being noncompliant with FCC Class A requirements and void the user's authority to operated the equipment.

Japanese Radio Frequency Interference VCCI

This equipment is in the Class A category information technology equipment based on the rules of Voluntary Control Council For Interference by Information Technology Equipment (VCCI). When used in a residential area, radio interference may be caused. In this case, user may be required to take appropriate corrective actions.

Figure 1

この装置は、クラスA情報技術装置です。この装置を家庭環境で使用すると電波妨害を引き起こすことがあります。この場合には使用者が適切な対策を講ずるよう要求されることがあります。

VCCI-A

Korean RFI Statement

1. Equipment Name (Model Name):
2. Certification No:
3. Name of Certification Recipient:
4. Date of Manufacture:
5. Manufacturer/Nation:

Figure 2

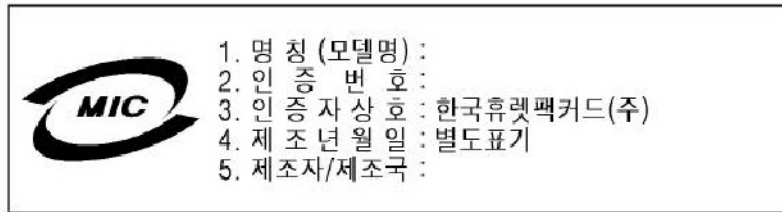

Certification Number: E - AAAAA - BB - CCCC

- E: EMC registration
- AAAAA: equipment codes (RRL notice, 2000.10.26)
- BB: certification year
- CCCC: registration number

Figure 3

Korean RFI

사용자 안내문 (A 급기기)

이 기기는 업무용으로 전자파 장애경정을 받은 기기이오니, 만약 잘못 구입 하셨을 때에는 구입한 곳에서 비업무용으로 교환 하시기 바랍니다.

사용자 안내문 (B 급기기)

이 기기는 비업무용으로 전자파 장애경정을 받은 기기로서, 주거지역에서는 물론 모든 지역에서 사용할 수 있습니다.

Translation

Class A Equipment:

Please note that this equipment has been approved for business purpose with regards to electromagnetic interference, if purchased un error for use in residential area, you may wish to exchange the equipment where you purchase it.

Class B Equipment :

Please note that this equipment has been approved for non-business with regards to electromagnetic interference. So, this equipment can be allowed to use all area as well as residential area.

European Union RFI Statement

This is a Class A product. In a domestic environment this product may cause radio interference in which case the user may be required to take adequate measures.

Canada RFI Statement

This Class A digital apparatus complies with Canadian ICES-003.

Notice relative aux interférences radioélectriques (Canada)

Cet appareil numérique de la classe A est conforme à la norme NMB-003 du Canada.

BSMI (Taiwan)

This product is fully compliant to CNS 13438 (CISPR 22: 1993) Class A. The EMC label is in the form shown in Figure 4. The eight # signs represent an eight-character, alpha-number string.

Figure 4

檢磁 #####

Figure 5

警告使用者：
這是甲類的資訊產品，在居住的環境中使用時，可能會造成射頻干擾，在這種情況下，使用者會被要求採取某些適當的對策。

Acoustics (Germany)

Acoustic Noise (A-weighted Sound Pressure Level LpA) measured at the bystander position, normal operation, to ISO 7779: LpA = 65.1 dB.

Geräuschemission (Deutschland)

Lärmangabe (Schalldruckpegel LpA) gemessen am fiktiven Arbeitsplatz bei normalem Betrieb nach DIN 45635, Teil 19: LpA = 65.1 dB.

IT Power System

This product has not been evaluated for connection to an IT power system (an AC distribution system having no direct connection to earth according to IEC 60950).

TT, TN-C, and TN-C-S Power Systems

These products should not be connected to power systems that switch open the return lead when the return lead also functions as the protective earth.

High Leakage Current

WARNING **High leakage current. Ground (earth) connection essential before connecting the supply.**

Installation Conditions

See installation instructions before connecting this equipment to the input supply.

Voir la notice d'installation avant de raccorder au réseau.

WARNING Please note the following conditions of installation:

Install a PE (protective earthing) conductor that is identical in size, insulation material, and thickness to the branch-circuit supply conductors. The PE conductor insulation must be green with yellow stripes. The earthing conductor is to be connected from the unit to the building installation earth or, if supplied by a separately derived system, at the supply transformer or motor-generator set grounding point.

WARNING NORDIC Class 1 Equipment

Denmark: Før tilslutning af de øvrige ledere, se medfølgende installationsvejledning.

WARNING NORDIC Class 1 Equipment

Sweden: Apparaten skall anslutas till jordat uttag, när den ansluts till ett nätverk.

Multiple Power Sources and Cords

This equipment may be configured with dual-input line sources. Hazardous voltages and energy may be present even after the removal of a single input source. Trained service personnel must follow the guidelines stipulated in the *Service Guidelines* section of the Superdome EPSS.

WARNING Remove both input power sources before replacing an internal fuse.

WARNING If the system has two PDCA installed, ensure that power is removed from both PDCA before removing fuses.

Lithium Battery Caution

WARNING Observe the correct polarity when changing the lithium battery. There is a danger of explosion if battery is installed incorrectly.

Replace only with the same or equivalent type recommended by the manufacturer. Dispose of used batteries according to the manufacturer's instructions and local disposal requirements.

Australian C-Tick Label

Figure 6



International Symbols (IEC335-1)

Figure 7

Four Wire Connection

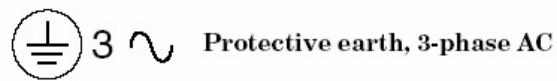
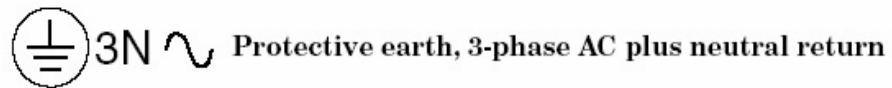

Figure 8

Five Wire Connection



Associated Documents

The following documents provide more details on the topics presented in this manual:

- *Standard for the Protection of Electronic Computer Data Processing Equipment*, (NFPA75) National Fire Protection Association
- EIA Standard RS-232-C, Electronic Industries Association
- *Electrostatic Discharge Failures of Semiconductor Devices*, Unger, B.A. 1981, Bell Laboratories
- IEC 60950, EN 60950, UL 60950, CSA 22.2 No. 950 *Standards for Safety of Information Technology Equipment*
- IEC 60417, IEC 335-1, ISO 3864, IEC 617-2 International Symbols

Figure 9

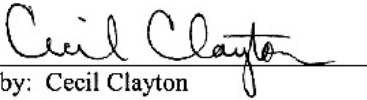
DECLARATION OF CONFORMITY																													
according to ISO/IEC Guide 22 and EN 45014																													
Manufacturer's Name:	Hewlett-Packard Company																												
Address:	3000 Waterview Parkway Richardson, TX 75080, USA																												
Declares that the product:																													
Product Name:	I/O Expansion (IOX) cabinet for SuperDome																												
Model Number(s):	SPP6:IOX, SPP6-1:XPC, SPP6-2:XUC/RDM, SPP6-3:ICE																												
Base Product Number(s):	A5861A:IOX, A5861-26001:XPC, A5861-26002:XUC, A5861-26003:RDM, A5862A:ICE																												
Product Option(s):	All																												
Conforms to the following Product Specifications:																													
Safety:	IEC 60950:1999 (with national differences for the countries listed on page 2) EN 60950:2000 UL 60950:2000																												
EMC:	<table style="width: 100%; border: none;"> <tr> <td style="padding: 2px 5px;">CISPR 22 3rd edition:1997/ EN 55022:1998</td> <td style="padding: 2px 5px;">Class A</td> </tr> <tr> <td style="padding: 2px 5px;">EN 55022:1998, Class A, 30 MHz to 5 GHz</td> <td style="padding: 2px 5px;">Radiated Emissions</td> </tr> <tr> <td style="padding: 2px 5px;">EN 55022:1998, Class A, 150 kHz to 30 MHz</td> <td style="padding: 2px 5px;">Conducted Emissions</td> </tr> <tr> <td style="padding: 2px 5px;">CISPR 24:1997/EN 55024:1998</td> <td style="padding: 2px 5px;">Immunity for ITE</td> </tr> <tr> <td style="padding: 2px 5px;">EN 61000-4-2:1995, 8kV CD / 15kV AD</td> <td style="padding: 2px 5px;">ESD</td> </tr> <tr> <td style="padding: 2px 5px;">EN 61000-4-3:1996,100kHz-1GHz, 10V/m, 1kHz AM</td> <td style="padding: 2px 5px;">Radiated Immunity</td> </tr> <tr> <td style="padding: 2px 5px;">ENV 50204:1995, 900MHz/1.89GHz, PM, 10 V/m</td> <td style="padding: 2px 5px;">Radiated Immunity</td> </tr> <tr> <td style="padding: 2px 5px;">EN 61000-4-4:1995, 1kV Power line, 0.5kV signal cables</td> <td style="padding: 2px 5px;">EFT</td> </tr> <tr> <td style="padding: 2px 5px;">EN 61000-4-5:1995, 2kV CM, 1kV DM</td> <td style="padding: 2px 5px;">Surge</td> </tr> <tr> <td style="padding: 2px 5px;">EN 61000-4-6:1996, 150kHz - 400MHz, 3V_{rms}, 1kHz AM</td> <td style="padding: 2px 5px;">Conducted Immunity</td> </tr> <tr> <td style="padding: 2px 5px;">EN 61000-4-8:1993, 3 A/m, 50Hz</td> <td style="padding: 2px 5px;">Magnetic Immunity</td> </tr> <tr> <td style="padding: 2px 5px;">EN 61000-4-11:1994, 11V_{rms} (10ms), 161V_{rms} (0.5s), 11 V_{rms} (5s)</td> <td style="padding: 2px 5px;">Voltage Dips & Interrupts</td> </tr> <tr> <td style="padding: 2px 5px;">EN61000-3-2; '95 +A14</td> <td style="padding: 2px 5px;">Power line Harmonics</td> </tr> <tr> <td style="padding: 2px 5px;">EN61000-3-3; '95</td> <td style="padding: 2px 5px;">Voltage Flicker</td> </tr> </table>	CISPR 22 3rd edition:1997/ EN 55022:1998	Class A	EN 55022:1998, Class A, 30 MHz to 5 GHz	Radiated Emissions	EN 55022:1998, Class A, 150 kHz to 30 MHz	Conducted Emissions	CISPR 24:1997/EN 55024:1998	Immunity for ITE	EN 61000-4-2:1995, 8kV CD / 15kV AD	ESD	EN 61000-4-3:1996,100kHz-1GHz, 10V/m, 1kHz AM	Radiated Immunity	ENV 50204:1995, 900MHz/1.89GHz, PM, 10 V/m	Radiated Immunity	EN 61000-4-4:1995, 1kV Power line, 0.5kV signal cables	EFT	EN 61000-4-5:1995, 2kV CM, 1kV DM	Surge	EN 61000-4-6:1996, 150kHz - 400MHz, 3V _{rms} , 1kHz AM	Conducted Immunity	EN 61000-4-8:1993, 3 A/m, 50Hz	Magnetic Immunity	EN 61000-4-11:1994, 11V _{rms} (10ms), 161V _{rms} (0.5s), 11 V _{rms} (5s)	Voltage Dips & Interrupts	EN61000-3-2; '95 +A14	Power line Harmonics	EN61000-3-3; '95	Voltage Flicker
CISPR 22 3rd edition:1997/ EN 55022:1998	Class A																												
EN 55022:1998, Class A, 30 MHz to 5 GHz	Radiated Emissions																												
EN 55022:1998, Class A, 150 kHz to 30 MHz	Conducted Emissions																												
CISPR 24:1997/EN 55024:1998	Immunity for ITE																												
EN 61000-4-2:1995, 8kV CD / 15kV AD	ESD																												
EN 61000-4-3:1996,100kHz-1GHz, 10V/m, 1kHz AM	Radiated Immunity																												
ENV 50204:1995, 900MHz/1.89GHz, PM, 10 V/m	Radiated Immunity																												
EN 61000-4-4:1995, 1kV Power line, 0.5kV signal cables	EFT																												
EN 61000-4-5:1995, 2kV CM, 1kV DM	Surge																												
EN 61000-4-6:1996, 150kHz - 400MHz, 3V _{rms} , 1kHz AM	Conducted Immunity																												
EN 61000-4-8:1993, 3 A/m, 50Hz	Magnetic Immunity																												
EN 61000-4-11:1994, 11V _{rms} (10ms), 161V _{rms} (0.5s), 11 V _{rms} (5s)	Voltage Dips & Interrupts																												
EN61000-3-2; '95 +A14	Power line Harmonics																												
EN61000-3-3; '95	Voltage Flicker																												
Supplementary Information:																													
The product as stated above complies with the requirements of the Low Voltage Directive 73/23/EEC, and the EMC Directive 89/336/EEC, as amended by 93/68/EEC.																													
<u>May 31, 2001</u> Date	 by: Cecil Clayton Hewlett-Packard Company Product Regulations Manager																												
European Contact: Your Local Hewlett-Packard Sales and Service Office or Hewlett-Packard GmbH, Department HQ-TRE / Standards Europe, Herrenberger Strasse 130, D-71034 Boeblingen, Germany (FAX +49-7031-14-3143)																													

FCC Regulations (USA Only)

The Federal Communications Commission (in 47 CFR Part 15) has specified that the following notice be brought to the attention of the users of this product.

Note: This equipment has been tested and found to comply with the limits for a Class A digital device, pursuant to Part 15 of the FCC Rules. These limits are designed to provide reasonable protection against harmful interference when the equipment is operated in a commercial environment. This equipment generates, uses, and can radiate radio frequency energy and, if not installed and used in accordance with the instruction manual, may cause harmful interference to radio communications. Operation of this equipment in a residential area is likely to cause harmful interference in which case the user will be required to correct the interference at his own expense.

The user is cautioned that changes or modifications not expressly approved by the party responsible for compliance (Hewlett-Packard) could result in the equipment being non-compliant with the FCC Class A requirements and void the user's authority to operate the equipment.

Additional International Approvals

AS/NZS 3548:1995 C-Tick & Supplier Code (N279)
 CSA C22.2 No. 60950:2000
 ICES-003 Issue 3
 VCCI Class A
 BSMI, CNS-13438 11/94(Rev. 5/97)
 MIC No. 1996-18, Class A
 GB4943-1995
 GB9254-1988

Australia/New Zealand
 Canada
 Canada
 Japan
 Taiwan
 Korean
 China
 China

IEC 60950 Evaluated for Country National Differences

CENELEC, AT = Austria, AU = Australia, BE = Belgium, CA = Canada, CH = Switzerland,
 CN = China, CZ = Czech Republic, DE = Germany, DK = Denmark, ES = Spain, FI = Finland,
 FR = France, GB = United Kingdom, GR = Greece, HU = Hungary, IE = Ireland, IL = Israel,
 IN = India, IT = Italy, JP = Japan, KR = Republic of Korea, NL = The Netherlands, NO = Norway,
 PL = Poland, RU = Russia, SE = Sweden, SG = Singapore, SI = Slovenia, SK = Slovakia,
 TR = Turkey, UA = Ukraine, US = United States, ZA = South Africa

1 Introduction

The I/O Expansion (IOX) Cabinet provides additional I/O capacity for the Superdome 32, and 64 Way server. The IOX provides up to 72 Peripheral Controller Interface (PCI) slots in six 12-slot I/O chassis. Two IOX cabinets provide up to 96 PCI slots in eight 12-slot I/O chassis. There are two sizes of IOX cabinets: the 1.96-meter cabinet and the 1.6 meter cabinet.

Overview

Figure 1-1 illustrates a typical Superdome server and I/O cabinet installation. Shown are a Superdome 32 Way and one IOX cabinet.

Figure 1-1 I/O Expansion Cabinet Shown With Superdome 64 Way



Cabinet layout

The IOX uses an HP modified Rosebowl rack: an RBII-D' 19-inch cabinet.

The I/O Expansion cabinet is physically partitioned into the following modules: the I/O Expansion Utilities Chassis (XUC), the I/O Expansion Rear Display Module (RDM), the I/O Expansion Power Chassis (XPC), and the I/O Chassis Enclosure (ICE). Each ICE supports up to two 12-slot I/O chassis.

- I/O Chassis Enclosure (ICE)
- I/O Expansion Utilities Chassis (XUC)
- I/O Expansion Power Chassis (XPC)
- Rear Display Module (RDM)

The four basic components can be further divided into controllers and functional units as shown in Table 1-1.

Figure 1-2 IOX Components

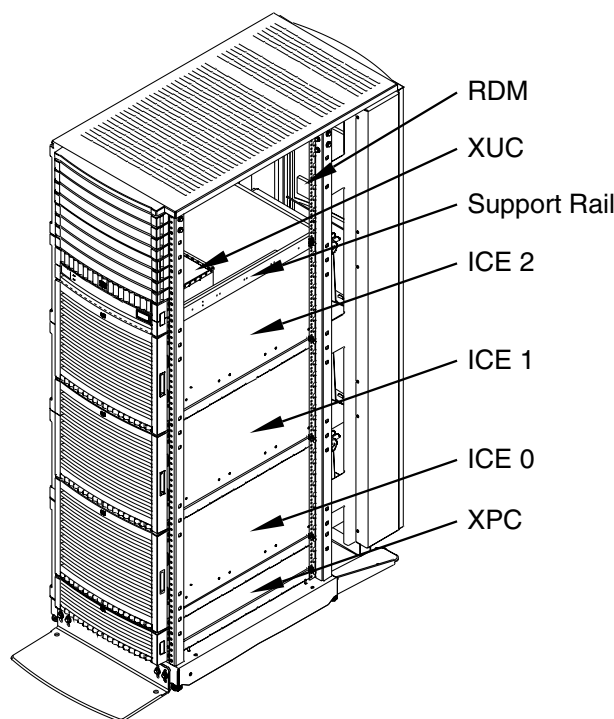

60IOX016
5/2/01

Table 1-1 I/O Expansion Cabinet Components

Functional unit	Component Location	Quantity per Cabinet
PM/CLU	XUC	1
SBCHL (Lite) (Hub Configuration)	XUC	1
I/O Expansion Utilities Connector Board (XUCB)	XUC	1
I/O Expansion Control Panel Assembly (CPA)	XUC	1
I/O Expansion Front Panel Board (XFPB)	CPA	1

Table 1-1 I/O Expansion Cabinet Components

Functional unit	Component Location	Quantity per Cabinet
Utilities cooling fan module (with fan power board)	XUC	1
I/O Expansion Front Panel Board (XFPB)	RDM	1
I/O Expansion Master I/O Backplane (XMIOB)	ICE	2 per ICE
I/O chassis (12-slot)	ICE	2 max per ICE

The maximum number of ICEs varies with the cabinet size and the type of Superdome server to which it connects.

ICE

The ICE supports a maximum of two 12-slot I/O chassis. Each I/O chassis interfaces with an I/O Expansion Master I/O backplane (XMIOB) contained within an EMI enclosure and installed on the ICE tray.

Figure 1-3 ICE Layout

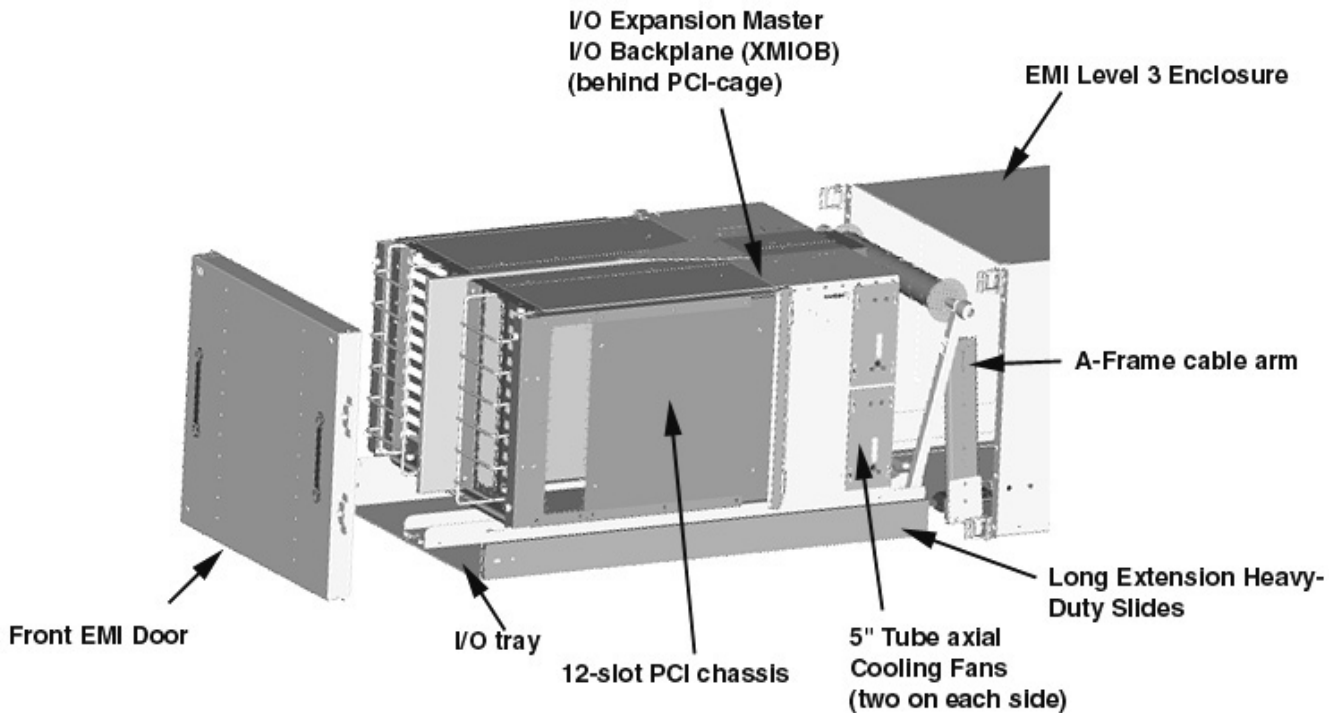

The ICE I/O tray slides forward out of the cabinet to allow access to the PCI slots. Cables are routed out of the front of the I/O chassis, underneath the chassis, and out the rear of the enclosure. A cable management system at the rear of the ICE provides the service loop necessary to allow the forward movement of the ICE tray.

Cooling is provided by redundant (N+1=4), hot-swappable fans located in the rear.

The ICE chassis external dimensions (excluding cosmetic panels and mounting flanges) are 394 mm (15.51 in) high X 448 mm (17.64 in) wide X 948 mm (37.3 in) deep.

XMIOB

The XMIOB is a connector board for one 12-slot I/O chassis. It connects to the I/O chassis backplane (HIOB). XMIOBs exist in pairs, supporting two 12-slot chassis in a single ICE: Chassis 1 and Chassis 3. They are connected together by a bridge cable. For architectural reasons, the two I/O chassis are distinguished as chassis 1 and chassis 3.

The XMIOB routes necessary utilities signals from the utilities inlet connector. It also routes other utilities signals to the bridge connector. The XMIOB also has connectors to feed through REO and clock signals to the HIOB, as well as a connector and optional filter components for the chassis OL* LED signals. Chassis sheet metal and different connector sizes prevent illegal cable connection scenarios.

Figure 1-4 **XMIOB Location**



I/O Chassis

Each ICE can hold two 12-slot I/O chassis. PCI controller cards interface with cables that approach the I/O chassis from the front. Cables are attached to the PCI cards from the front of the I/O chassis. The chassis can be removed with or without extending the ICE tray. Figure 1-5 shows the I/O chassis being inserted into the ICE.

Figure 1-5 I/O Chassis

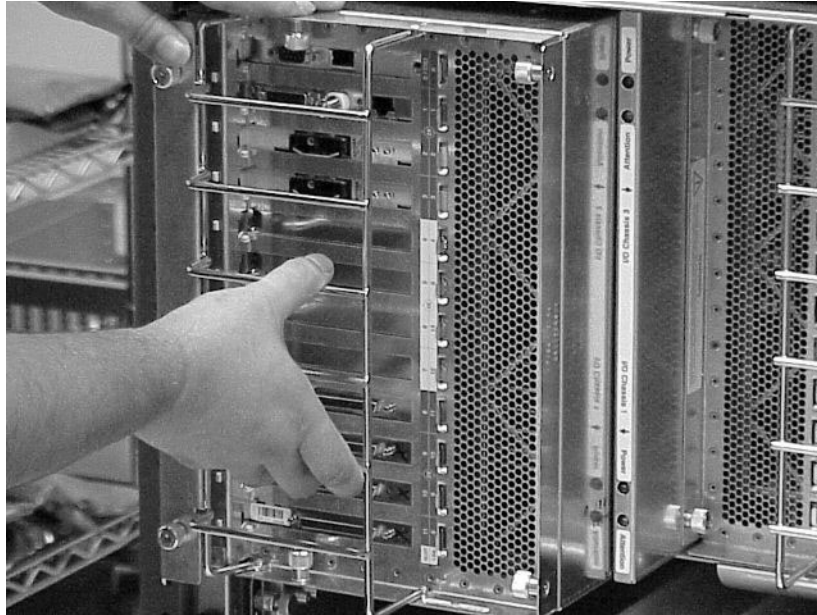

XUC

The XUC provides utilities functions and clock distribution for components in the IOX. It is also connected to the Superdome server by way of a GSP bus link. Each IOX cabinet requires one XUC.

The XUC provides utilities functions and clock distribution for IOX components. These components are the ICE and XPC. The XUC provides clock signal distribution for the ICEs.

The XUC also provides a connection to the rear display module (RDM).

Cooling is provided by monitored and redundant (N+1=2), hot-swappable fans installed in a module. The fans operate when Housekeeping voltage is supplied. Housekeeping voltage is converted to 12VDC on the Fan Power Board (XfanB) located in the XUC fan module. The fans only operate when 48V is present.

Clock and GSP Bus cable shields are terminated at the rear bulkhead by cable mounted ferrules.

The XUC chassis external dimensions (excluding cosmetic panels and mounting flanges) are 119 mm (4.7 in) high by 425 mm (16.7 in) wide by 288 mm (11.3 in) deep.

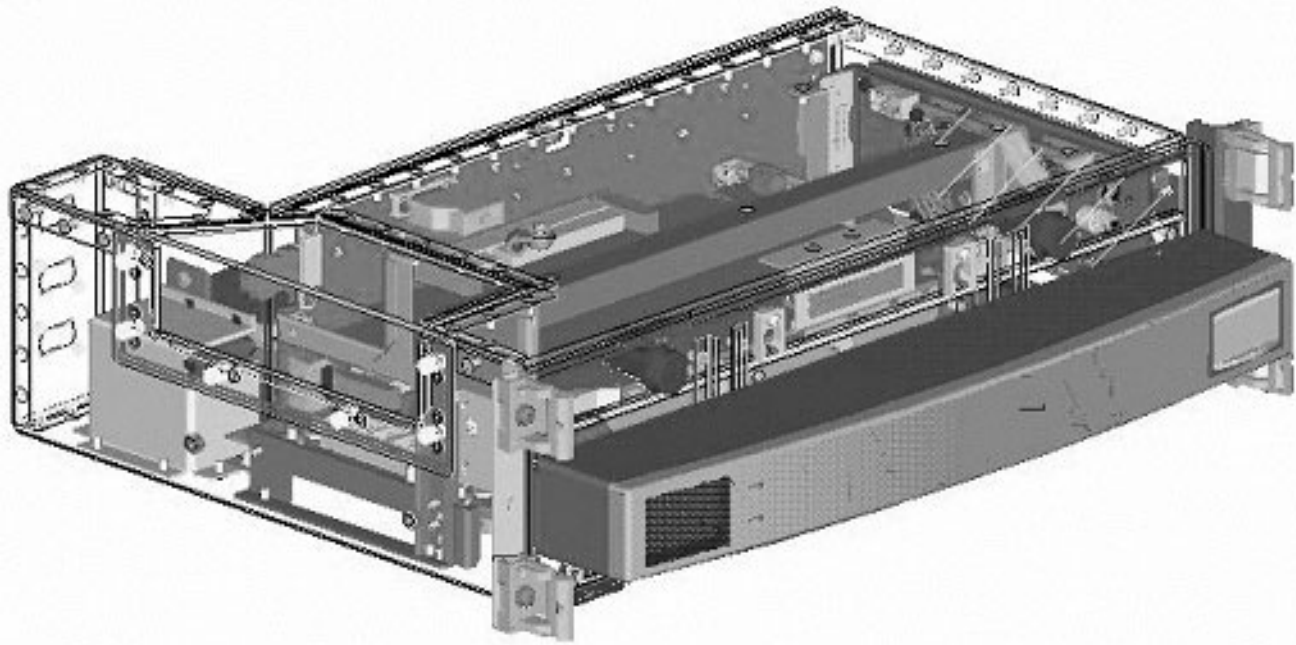
Figure 1-6 XUC

XPC

The XPC is a part of the AC-to-DC power subsystem. The AC-to-DC power subsystem comprises one or two Bulk Power Supplies (BPS) contained within one XPC. The purpose of the XPC is to bus the AC and control I/O signals to the BPSs and to bus the BPS outputs (48Vdc, 5VHK, and I/O signals) to the output connectors at the rear of the XPC. The external dimensions of the XPC, excluding cosmetic panels and mounting flanges, are 444.6 mm (17.5 in) wide x 127 mm (5.0 in) tall x 716 mm (28.2 in) deep. The mass of the XPC is 17.37 kg (38.3 lbs.).

The power subsystem has n+1 redundancy for the AC-to-DC conversion and the AC inputs. AC-to-DC n+1 redundancy is achieved with two BPSs, any one of which can support the load. AC input redundancy is achieved with two single-phase AC power cords connected to dual (n+1) primary power grids, either one of which can support the load.

Figure 1-7 XPC Location

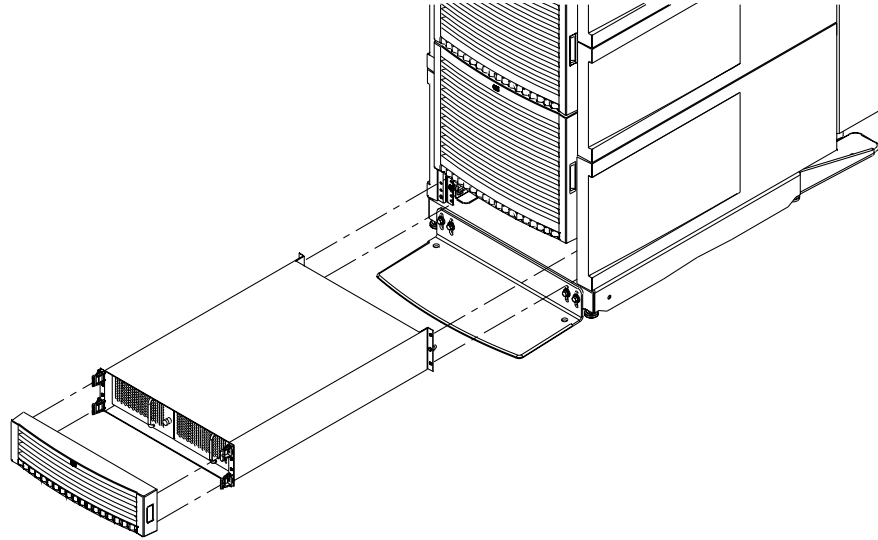

60IOX012
11/17/00

A BPS is a modular, hot swappable, power supply that is installed into an XPC slot. Each BPS is configured as an n+1 redundant, hot swappable, current sharing, and modular power supply within the power subsystem. Each BPS is capable of operation in an AC-power load share mode (n+1), where both AC sources, if present, are equally loaded. If one AC source is absent or out of range, operation continues from the second AC source. This is a transparent operation.

NOTE The BPS for IOX is the same as that for Superdome.

Figure 1-8 XPC Block Diagram

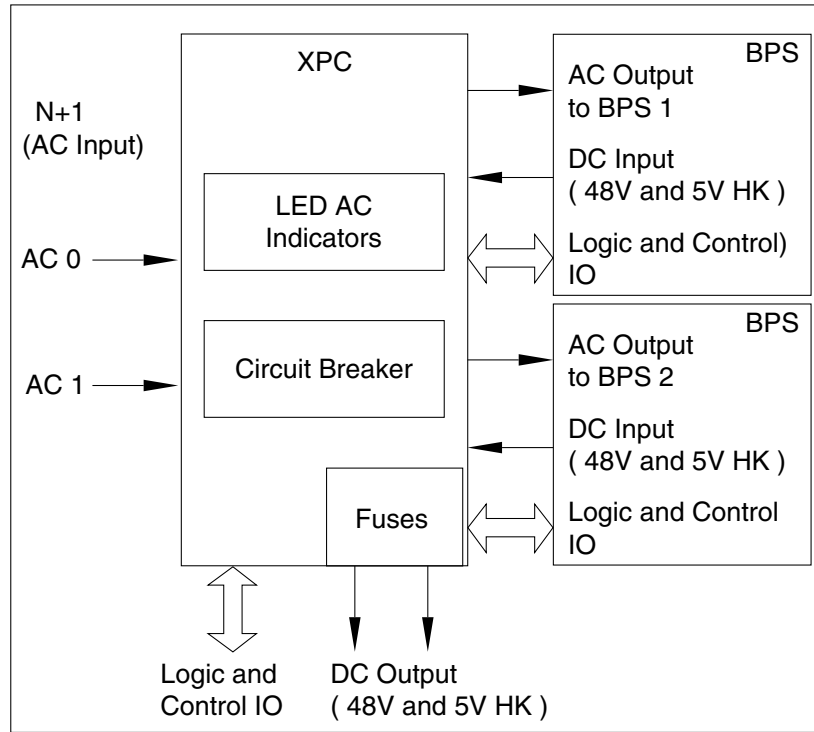

60IOX024
12/14/00

Additionally, each BPS accepts and generates control I/O interface signals from/to the Power Monitor Subsystem (PM3) assembly, which monitors and controls the power system. The PM3 detects the number and type of BPS modules present. If any of these modules fails, the PM3 may shut down the system dependent on the specific anomaly. The PM3 controls the On/Off status of the XPC +48Vdc rail.

Figure 1-9 BPS Functional Diagram

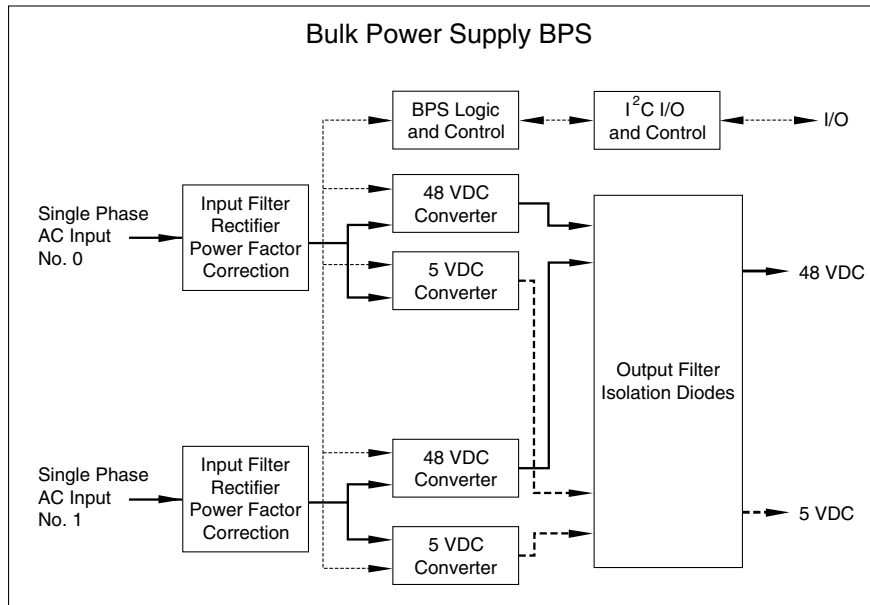

60IOX025
5/14/01

The I/O expansion cabinet requires a single phase 220 VAC input. Each BPS has push-button resettable breakers located above each AC power input connector.

Table 1-2 lists the AC power requirements for the I/O expansion cabinet.

Table 1-2 I/O Expansion Cabinet Power Requirements

Requirements	Value
Nominal input voltage	200-240 (VAC rms)
Input voltage range (minimum-maximum)	176-264 (VAC rms)
Frequency range (minimum-maximum)	47-63 (Hz)
Number of phases	1
Marked Electrical input current	16A @ 200 VAC 20A @ 176 VAC
Maximum inrush current	90 max (A peak)
Power factor correction	0.95 minimum

Table 1-3 I/O Expansion Cabinet Component Power Requirements

Power Required (50 - 60 Hz)	VA
Fully configured cabinet	3200
I/O cardcage	500
ICE	600

The XPC distributes each single phase input to each BPS slot as shown in Figure 1-10.

Figure 1-10 AC Input Distribution

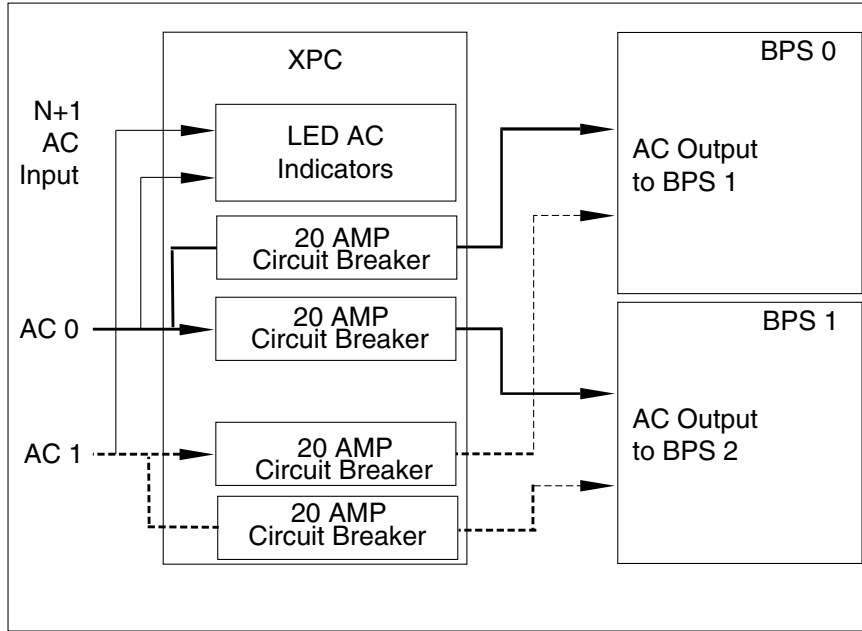

60IOX026
12/15/00

IOX Visual Indicators

This section outlines the visual indicators in the IOX.

ICE Visual Indicators

Indicators are provided on the ICE. I/O chassis Power and I/O chassis Attention LEDs are located on the center separator between the PCI card cages. The PCI Slot Power and PCI Slot Attention LEDs are located in the PCI card cage.

Table 1-4 lists the visual indicators on the ICE. All indicators require some action before they can be displayed.

Table 1-4 ICE Visual Indicators

Display	Location	Additional Actions Required
Cabinet Number	ICE Mounting Flange	Remove bezel
I/O chassis Number	Center Separator	Remove bezel
PCI Slot Number	I/O chassis Mounting Flange	Remove bezel and EMI panel.
I/O chassis Power LED	Center Separator	Remove bezel. Reduced visibility through EMI panel.
I/O chassis Attention LED	Center Separator	Remove bezel. Reduced visibility through EMI panel.
PCI Slot Power LED	I/O chassis card separator	Remove bezel and EMI panel assembly, extend tray and remove I/O chassis lid
PCI Slot Attention LED	I/O chassis card separator	Remove bezel and EMI panel assembly, extend tray and remove I/O chassis lid
I/O Fan Module Status LED	I/O Fan Module	Remove bezel and EMI panel assembly, extend tray. Reduced visibility from the rear.

The ICE has three areas of status LEDs:

- ICE center separator
- I/O chassis card separators
- Fans

ICE Center Separator

The separator in the ICE contains four LEDs: two for chassis 1 and two for chassis 3. See Figure 1-11.

Figure 1-11 **Center Separator**

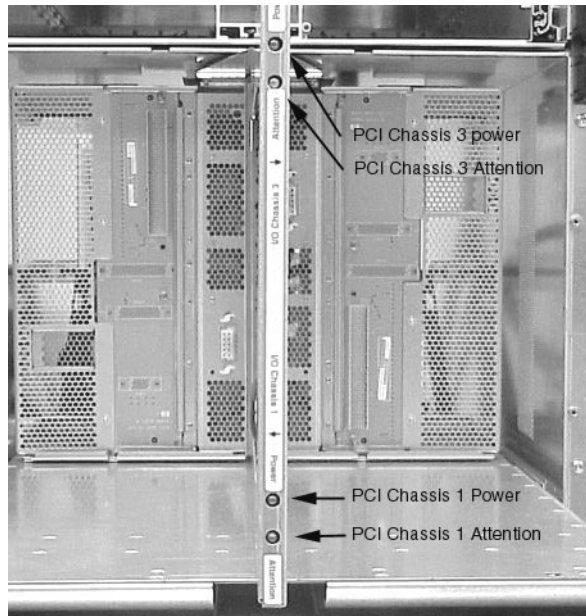

If the chassis power is within the valid range, the Power LEDs are green.

PCI Card Separators

Between each PCI card is a separator card. These cards indicate the voltage to each card. When the LED is green the voltage is within the valid range. If there is a problems, the LED is amber. See Figure 1-12.

Figure 1-12 **PCI Card Separators**

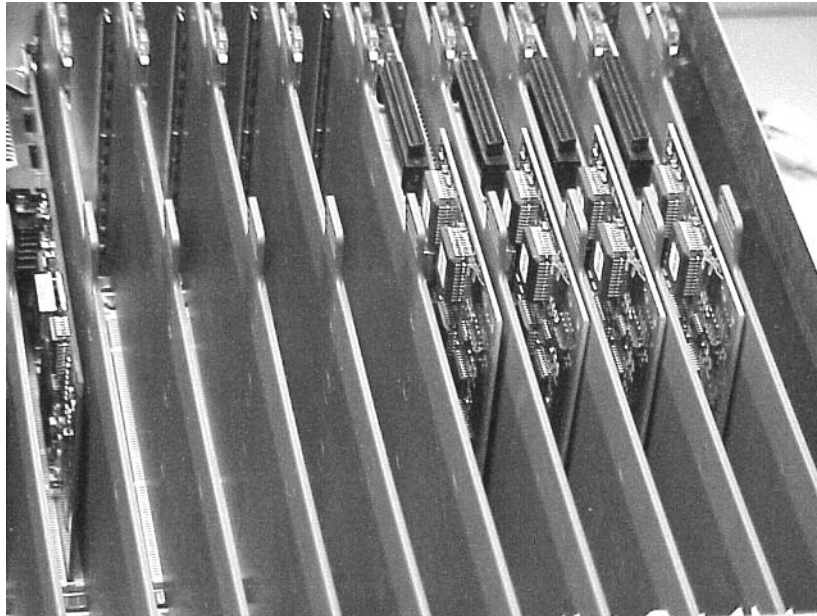

ICE Fan Status LEDs

Each of the four ICE fans has a status LED. If the fan is functional the LED is green.

NOTE There may be a delay of up to 60 seconds after turning on the 48V before the fan LEDs become active.

Figure 1-13 ICE Fan Status LEDs

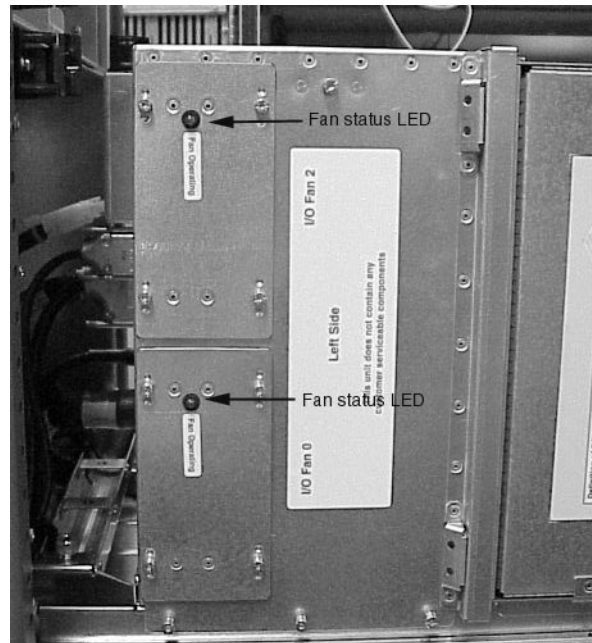

XPC visual Indicators

The XPC houses two BPSs and each has a set of LEDs both on the front and rear. Figure 1-14 shows the front view of the BPSs. See Figure 1-14.

Figure 1-14 BPS Front LEDs

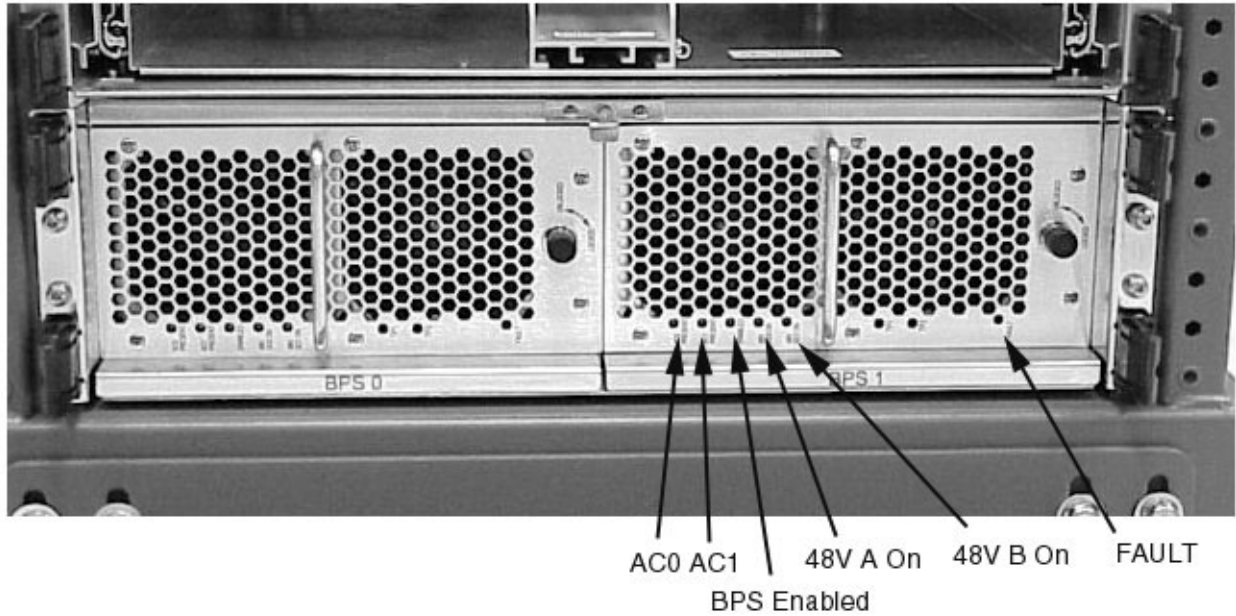

The meaning of each LED is given in Table 1-5.

Table 1-5 XPC Font LED Definitions

LED	Definition
AC0 Present	On (amber) when AC is present on side A. Valid AC is line voltage is present at connector 1
AC1 Present	On (amber) when AC is present on side B. Valid AC is line voltage is present at connector 2
BPS Enabled	On (green) when BPs is enabled.
48V A On	On (green) when 48V A is on and within valid limits
48V B On	On (green) when 48V B is on and within valid limits
FAULT	On (red) when there ia fault. BPS is shutdown due to unrecoverable error condition.

AC Power Input

There are two additional LEDs on the back of the XPC that indicate AC is present at the power connector.LED is green when AC is present.

Front and Rear Displays

IOX Control Panel Display (CPA)

The CPA mounts on the front of the XUC. The CPA contains one XFPB (IOX Front Panel Board) and an attached 48V power on/off switch cable assembly. It provides a 1-1/2 digit cabinet number display (decimal), and LEDs for +5.3V Housekeeping Good and +48V Good. These are directly visible over a wide angle from the front of the IOX. The XFPB also has an ambient temperature sensor.

Figure 1-15 **Location of CPA**



Rear Display Module (RDM)

Each IOX cabinet contains a Rear Panel Display (RDM) module. The RDM contains two, one-inch, seven-segment green displays for the cabinet number and two green “power good” LEDs for +5V housekeeping and +48V.

Figure 1-16 **RDM Module**

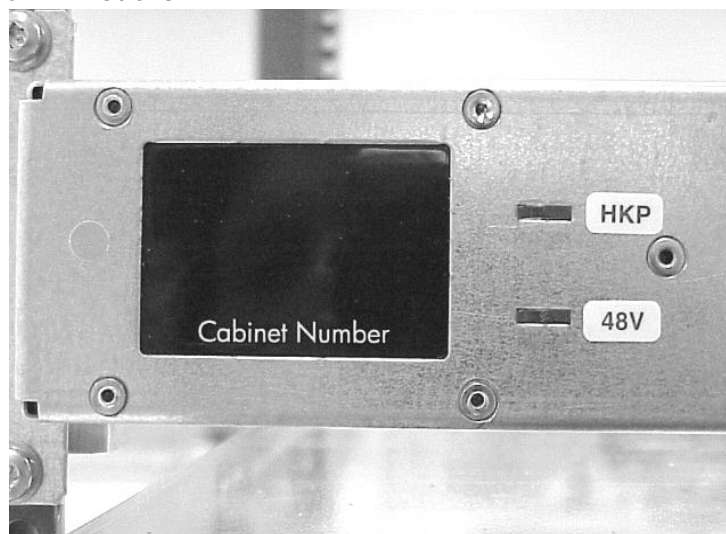

The rear door must be opened to view the RDM. Table 1-6 defines the RDM indicators.

Table 1-6 **RDM Display**

Display	Location	Additional Actions Required
Cabinet Number	Front surface	Open rear door to maximize visibility
48V Power	Front surface	Open rear door to maximize visibility
5.3V Housekeeping	Front surface	Open rear door to maximize visibility

Cabinet Description

The IOX cabinet is a welded steel frame with removable top, rear doors, casters, leveling feet, and an anti-tip mechanism as shown in Figure 1-18. The top piece is 16-gauge, cold-rolled steel. The base piece is 11-gauge, hot-rolled steel. Threaded grounding studs are provided near the base of every column, and at the top rear. The cabinet itself is not grounded.

Cabinet heights are measured in meters, inches, EIA units, and “U.” One EIA unit equals 1 U, which equals 44.45 mm (1.75 in). Internal equipment rails lock into slots in the vertical mounting columns and are fastened to the columns with screws. Columns are numbered for easy placement. Tie-together kits allow easy, secure mating of cabinets. The cabinet top and rear door are perforated for maximized cooling. The basic IOX cabinet is shown in Figure 1-17.

Figure 1-17 **IOX Cabinet (Rear View)**



The top cap is 16-gauge, cold-rolled steel (CRS). The top cap and forehead are attached at the factory. The top of the cabinet incorporates a ventilation path through the roof of the cabinet and a convection current heat exit for the heat generated by the installed equipment.

The cabinet columns are a folded design made of 12-gauge rolled steel that supports up to 2000 lbs. Running up the inside of the fold are square mounting slots for the rails and screw holes for securing the rails. The hole

placement conforms to EIA standards. The mounting columns are welded into place at the bottom corners of the frame and bolted at the top. The columns accept supporting rails into mounting slots. Each support rail pair attaches between the front and rear columns. The equipment is then mounted on the support rails.

The mounting columns have pre-positioned threaded inserts pressed into the hexagonal accessories holes in the front faces of the columns. The inserts are positioned to accept tie brackets, hinges, latches, and Plus.

Anti-Tip Stabilizer Feet

IOX cabinet has a field installable set of stabilization feet as standard equipment. These stabilization feet are installed at the front and rear of the cabinet.

WARNING Install the Anti-Tip stabilizer feet for safety.

Figure 1-18 Anti-Tip Stabilizer Feet

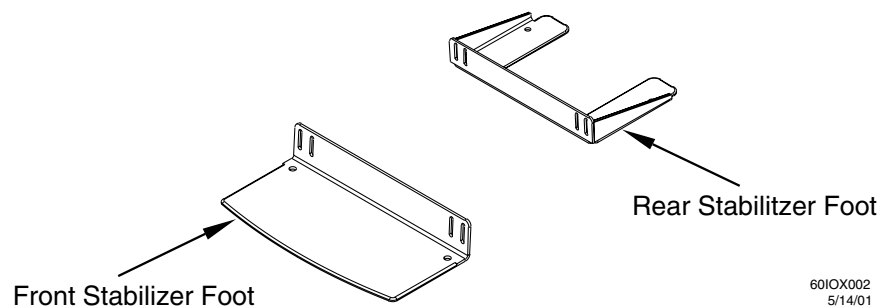

Heavy-Duty Casters

Each cabinet is provided with four, 7.6-cm (3 in) diameter, smooth rolling, heavy-duty urethane casters to facilitate moves over short distances. The casters are rated at 454.5 kg (1000 lbs) per caster.

Figure 1-19 **Heavy-Duty Casters**

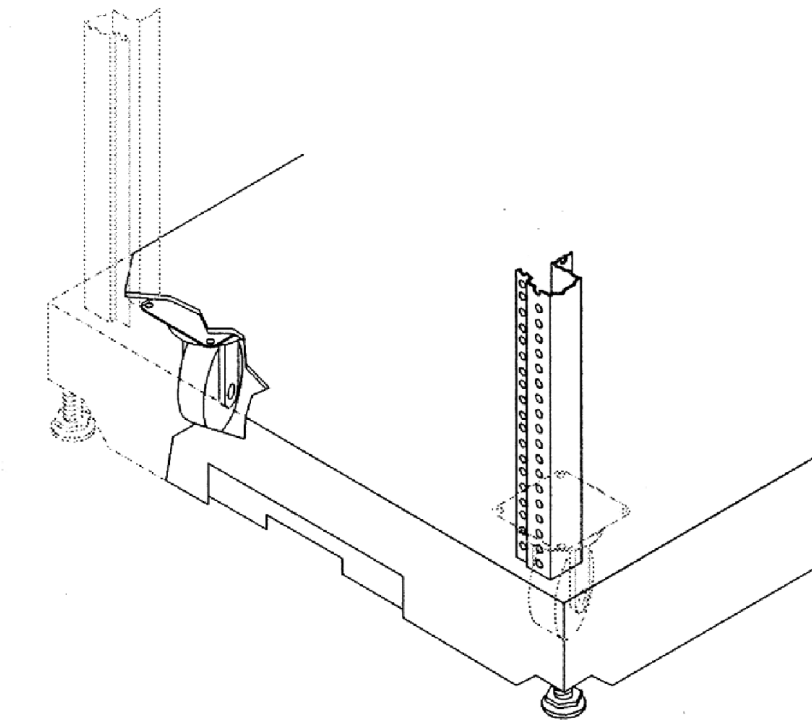

CAUTION Do not overload the raised floor. A fully loaded cabinet has a maximum gross weight of 995 kg (2188 lbs).

Leveling Feet

Four adjustable leveling feet come with the cabinet for stability and leveling. Levelers are located in each corner to level and stabilize the rack. For maximum accuracy, use a level while adjusting the feet.

Figure 1-20 **Leveling Feet**

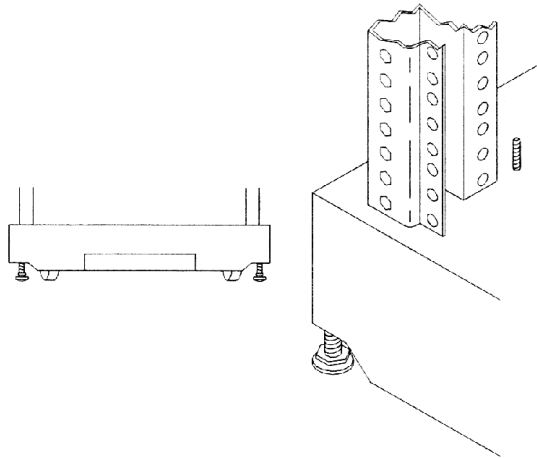

Rear Door

The rear door comes installed from the factory. Standard is a right-opening, perforated rear door with a lockable slam latch and sheet metal catch providing ventilation and security. The rear door can be mounted to open from either the left or the right. It is perforated for maximum airflow. It lifts on and off its hinges when open to about 45 degrees. The 1.96 m door weighs 11.8 kg (26 lbs). The 1.6 m rear door weighs 9.1 kg (20 lbs).

System Configurations

The allowed combinations of cabinet sizes, I/O chassis, slot totals, and free space for mounting other peripherals are summarized in Table 1-7.

CAUTION Do not use the top 8U of the 1.96-meter cabinet to mount IOX components.

Table 1-7 Allowable Configurations

Cabinet Size	XPC (pwr)	XUC (utilities)	12-slot ICE	Total number of I/O chassis	Total # slots	Free Rack Space
33 U (1.61m)	1	1	1	2	24	18 U
33 U (1.61m)	1	1	2	4	48	9 U
33 U (1.61m)	1	1	3	6	72	0 U
41 U (1.96m)	1	1	1	2	24	26 U
41 U (1.96m)	1	1	2	4	48	17 U
41 U (1.96m)	1	1	3	6	72	8 U

When configuring multiple Superdome and IOX cabinets, certain guidelines must be followed. Full I/O support of a Superdome 64 Way requires eight additional I/O connections. Therefore, two IOX cabinets are required. The IOX may be loaded with two ICEs in each IOX or three ICEs in one IOX with one ICE in the other IOX. Each IOX must have its own XUC and XPC.

REO Cabling between HD and IOX can cross only one additional cabinet. Therefore, in a Superdome 64 Way with two IOX (Figure 1-21), the far right server cabinet can not be connected to the far left IOX. In the figure, solid lines represent REO cables. Configurations (a), (b), and (c) are legal; while configuration (d) is illegal.

Figure 1-21 illustrates the allowable configurations between the Superdome server and the IOX.

Figure 1-21 Allowable Multi-Cabinet Configurations

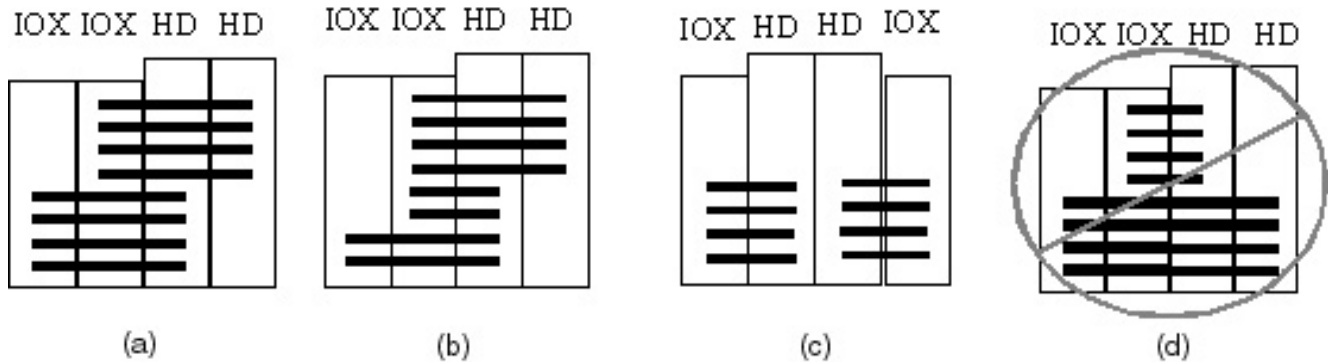

Peripheral Support

All peripherals qualified for use with Superdome and/or for use in an RBII-D rack are supported in the IOX cabinet as long as there is available space. Peripherals not connected to or associated with the Superdome system to which the IOX is attached may be installed in the IOX.

No servers except those required for Superdome system management such as test stations or High Availability Observatories may be installed in an IOX.

Peripherals installed in the IOX cannot be powered by the XPC. Provisions for peripheral AC power must be provided by a PDU or other means.

I/O Card and Cable Configuration Limits

The maximum number of I/O cards supported in a Superdome system is defined in the Superdome Installation Guide. There is distinction between cards located in the CPU cabinet and those in the IOX. The absolute worst case number of I/O cables that can result in an IOX is untenable from a cable management perspective. The design limits for maximum cards and their resulting cables in an IOX are defined in Table 1-8.

Table 1-8 IOX Maximum Card and Cable Configurations

Card Part #	Card Description	Cables per Card	Cable type	Max cards in 32W w/o IOX	Max cards in 32W w/IOX	Max cards in 64W w/IOX	Max Cables in 1 ICE	Max Cables in 2 ICE	Max Cables in 3 ICE
A5158A	FCMS - Tachlite	1	Fiber pair	48	96	192	24	48	72
A4800A	FWD SCSI	1	FWD SCSI	48	96	192	24	48	72
A5159A	FW SCSI (2-Port)	2	FW SCSI	24	48	96	48	48	96
A5149A	Ultra-2 SCSI	1	U SCSI	48	96	192	24	48	72
A5150A	Ultra-2 SCSI (2-port)	2	U SCSI	24	48	96	48	48	96
A5838A	2-port Ultra-2-SCSI + 2-port 100BT	2+2	U SCSI, 8-wire UTP	8	16	32	32	32	64
A5230A	10/100B-TX (RJ45)	1	8-wire UTP	24	48	96	24	24	48
A3738A	* 10/100B-TX (AUI, BNC, RJ45)	1	8-wire UTP, coax, or 15-wire	24	48	96	24	24	48
A5506B	10/100B-TX (4-port)	4	8-wire UTP	8	16	32	32	32	64

Table 1-8 IOX Maximum Card and Cable Configurations

Card Part #	Card Description	Cables per Card	Cable type	Max cards in 32W w/o IOX	Max cards in 32W w/IOX	Max cards in 64W w/IOX	Max Cables in 1 ICE	Max Cables in 2 ICE	Max Cables in 3 ICE
A4926A	1000B - SX	1	fiber pair	16	32	64	16	16	32
A4929A	1000B - T	1	UTP	16	32	64	16	16	32
A5513A	ATM 155 (MMF)	1	fiber pair	8	16	32	8	8	16
A5515A	ATM 155 (UTP5)	1	8-wire UTP	8	16	32	8	8	16
A5483A	ATM 622 (MMF)	1	Fiber pair	8	16	32	8	8	16
A3739B	FDDI Dual Attach	2	fiber pair	16	32	64	32	32	64
A5783A	Token Ring (4/16/100 Mb/s)	2	UTP, 9 wire max	8	16	32	16	16	32
A6092A	Hyperfabric (PCI 4X) Note: 4x slots only - limit of 2 per REO. Max numbers will increase in 2Q2001	1	copper	8	8	8	4	4	4
A6386A	Hyperfabric2 (PCI 4X)	1	Fiber pair	8	8	8	4	4	4
J3525A	X.25 (2-port)	1	RS232C, RS449, X.21, V.35, RS530	8	16	32	8 (32)	8 (32)	16 (64)
J3526A	X.25 (4-port)	2	RS232C, RS449, X.21, V.35, RS530	8	16	32	16	16	32

Table 1-8 IOX Maximum Card and Cable Configurations

Card Part #	Card Description	Cables per Card	Cable type	Max cards in 32W w/o IOX	Max cards in 32W w/IOX	Max cards in 64W w/IOX	Max Cables in 1 ICE	Max Cables in 2 ICE	Max Cables in 3 ICE
J3593A	Terminal MUX (64-port) Note 2:x slots only	1	???	8	16	32	8	8	16
J3592A	Terminal MUX (8-port) Note: 2x slots only	1 (8)	???	8	16	32	8 (64)	8 (64)	16 (128)
A5486A	PKC (Public Key Crypto) Note: no factory integration	0	N/A	8	16	32	0	0	0

Loading the Cabinet

Position Of Components in the Cabinet

The position of the IOX components - ICE, XUC, RDM and XPC - is independent of rack position. There are no mechanical, thermal or cabling limitations that affect the rack position of any of the components. There are however, supportability and ergonomic considerations that influence component position in the cabinet.

Since the CPA (on the XUC) and RDM display user information including cabinet number, they should be placed where the user can view the information easily. The RDM is installed directly behind the XUC.

The ICE requires access from the side, so it should be placed where OL* of PCI cards and other service operations can be performed easily, preferably not at the bottom of the cabinet.

IMPORTANT To facilitate service access, an ICE must not be installed at the top of a 1.96m cabinet. It should not be installed at the bottom of the rack, because the alignment and installation of horizontal PCI cards installed at the bottom of the rack can be problematic.

The BPSs are relatively heavy FRUs. Therefore, the lower the XPC is installed in the cabinet, the more cabinet stability is improved. Additionally, hoisting a BPS to a high position in the field can be difficult for some.

Recommended Loading Order

The recommended loading order of IOX components is to place the XPC as the lowest and the XUC and RDM

as the highest IOX components in the rack. IOX components should occupy contiguous cabinet space.

IMPORTANT Do not install any peripheral device between IOX modules.

The required number of ICEs should be installed between the XPC and XUC/RDM. In this way, open rack space for peripherals is maximized. The recommended loading order for a 1.6m rack is shown in Figure 1-22, and the recommended loading order for the 1.96m rack is shown in Figure 1-23.

Figure 1-22 1.6 Meter Rack Loading

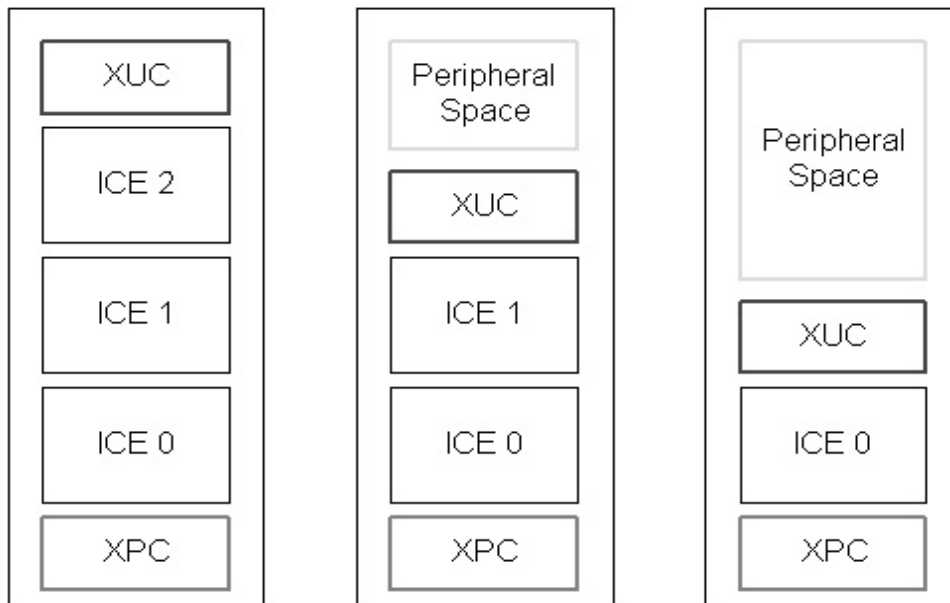
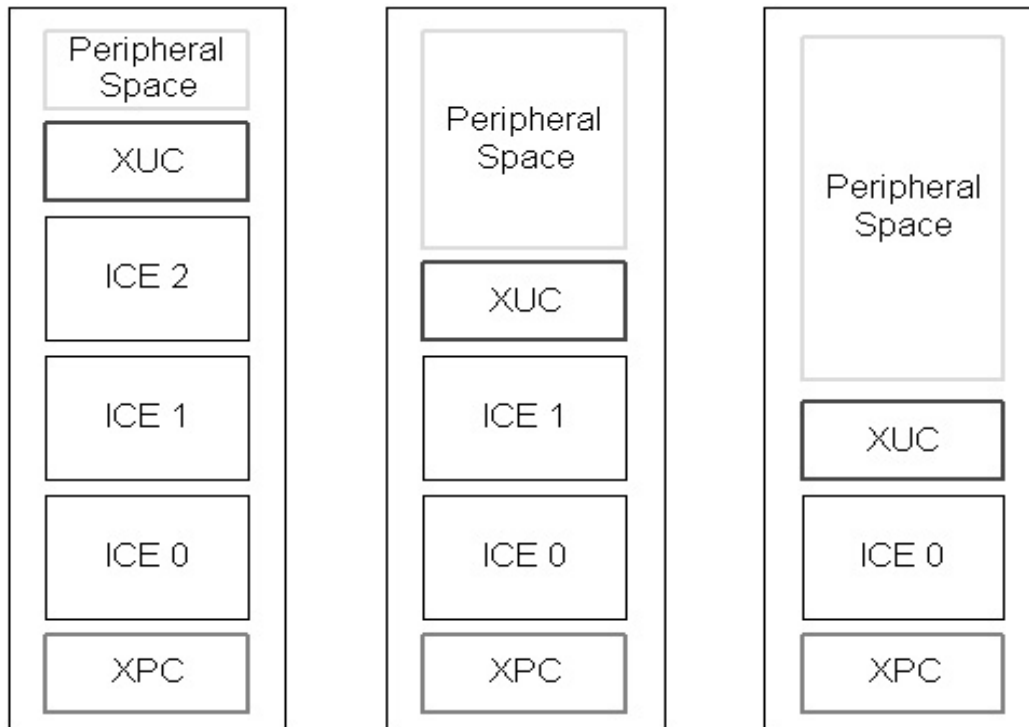

Figure 1-23 1.96-Meter Rack Loading



NOTE The IOX is shipped from the factory with all components installed in the recommended configuration. It should not be necessary to move components in the rack to accommodate adding an IOX (upgrade). If peripherals have been loaded, however, so that there are not 9U of contiguous rack space, it will be necessary to move peripherals to add the ICE.

Component Numbering

The logical numbering and identification scheme of IOX components is consistent with the rules applied to the Superdome system. Components are generally numbered starting at 0 and increasing left to right, then bottom to top, as viewed from the service or use access point. Exceptions to these rules in IOX exist for the I/O chassis in an ICE which are numbered 1 and 3 to match the numbering scheme in an I/O bay in the Superdome cabinet. XMIOBs are also numbered 1 and 3 to match the I/O chassis they serve. Figure 1-24 illustrates the logical component numbering for the IOX.

Figure 1-24 IOX Cabinet Component Numbering

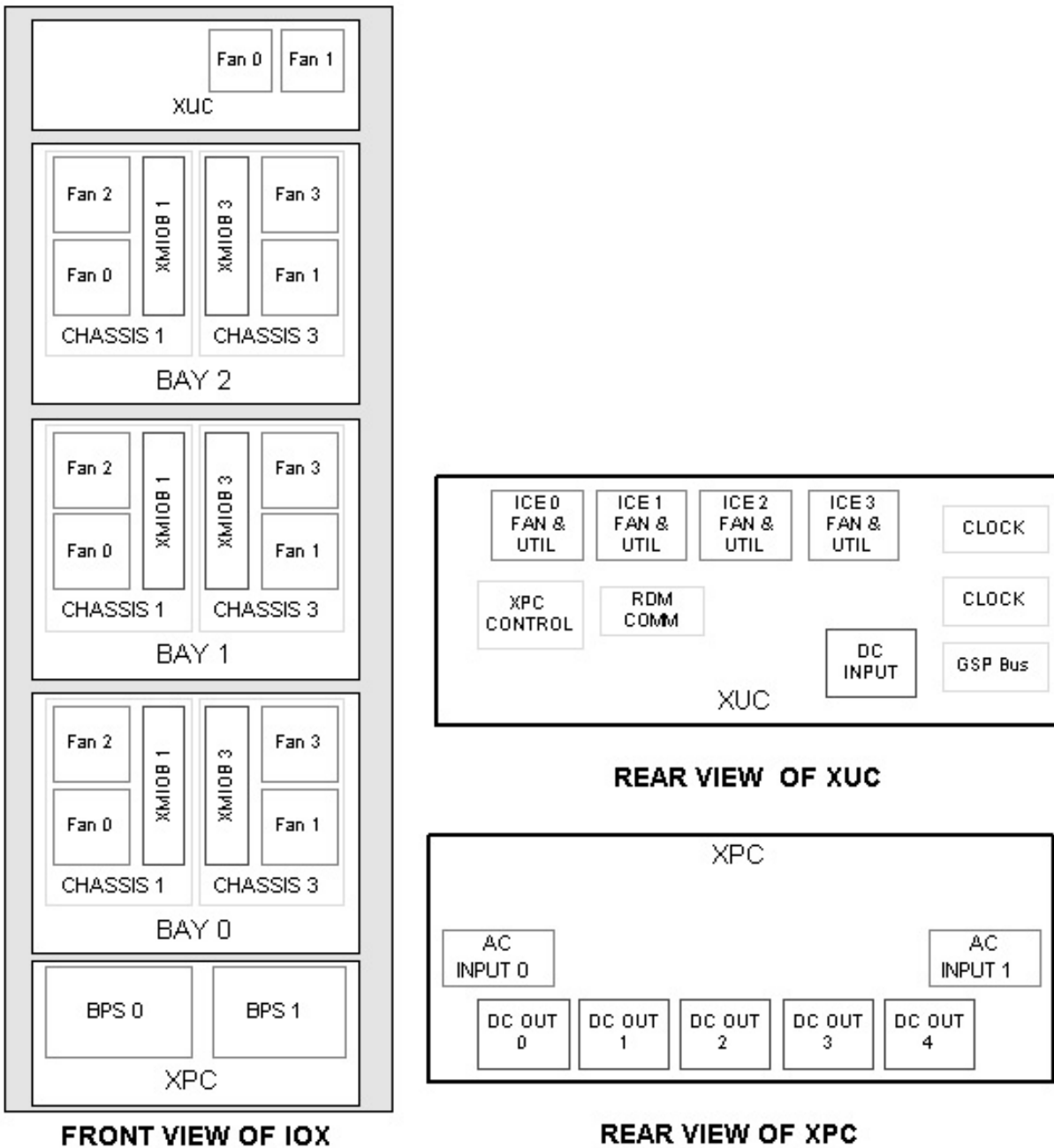

2 Upgrading the Superdome for IOX

Whenever an IOX is connected to a Superdome server, the server must have special cable exit panels. These panels contain EMI proof cable clamps, called R-PEC for REO cables and U-PEC for GSP bus cables, through which these cables pass between the IOX and Superdome. In addition to the cable exit panels, both the IOX and Superdome require cutouts for the cables through which to pass. IOXs are shipped with skins that contain these cutouts. The “pre-IOX-release” Superdome servers require upgrading to skins with cutouts and

cable exit panels.

If the IOX connects to a Superdome 32 Way, you must determine to which side the IOX is connected. If two IOXs are connected to the Superdome 64 Way server, you must upgrade both cable exit panels.

An IOX can also be connected to a Superdome 64 Way. In this case, you upgrade either the left side (looking from the front of the server cabinet) of one cabinet or the right side of the other cabinet or both.

When upgrading the right side cable exit panel, you must remove the rear door and the hinge assembly. When upgrading the left side you must only open the rear door.

Use the following procedure to remove the old Superdome side skin(s) and install new ones and to install new cable-exit panel(s).

IMPORTANT Before proceeding, determine which side(s) of the Superdome server must be upgraded.

Removing Old Side Skins

Step 1. Power down the Superdome server.

Step 2. Remove the side (the one to which the IOX is to be connected) and rear blower bezels on each server cabinet.

Figure 2-1 **Removing Blower Bezels**



NOTE Perform the following step only if installing the IOX on the rear-door-hinge side of the Superdome server.

Step 3. If the rear door must be removed, perform the following steps. Otherwise, skip this step and go to Step 4.

1. Remove the cable connected to the rear display cable located on the rear door, as shown in Figure 2-2.

Figure 2-2 **Removing the Rear Display Cable**



2. Remove the door grounding wire from the back channel, as shown in Figure 2-3.

NOTE The ground wire and/or connection point on your cabinet may be different to that shown in the figure.

Figure 2-3 **Removing Rear Door Grounding Wire**



3. Remove the rear door. Turn the door inward and lift it off its three hinges.

NOTE The door can only be lifted off the hinge pins by turning it inward as if you were partially closing it.

Figure 2-4 Removing the Superdome Rear Door

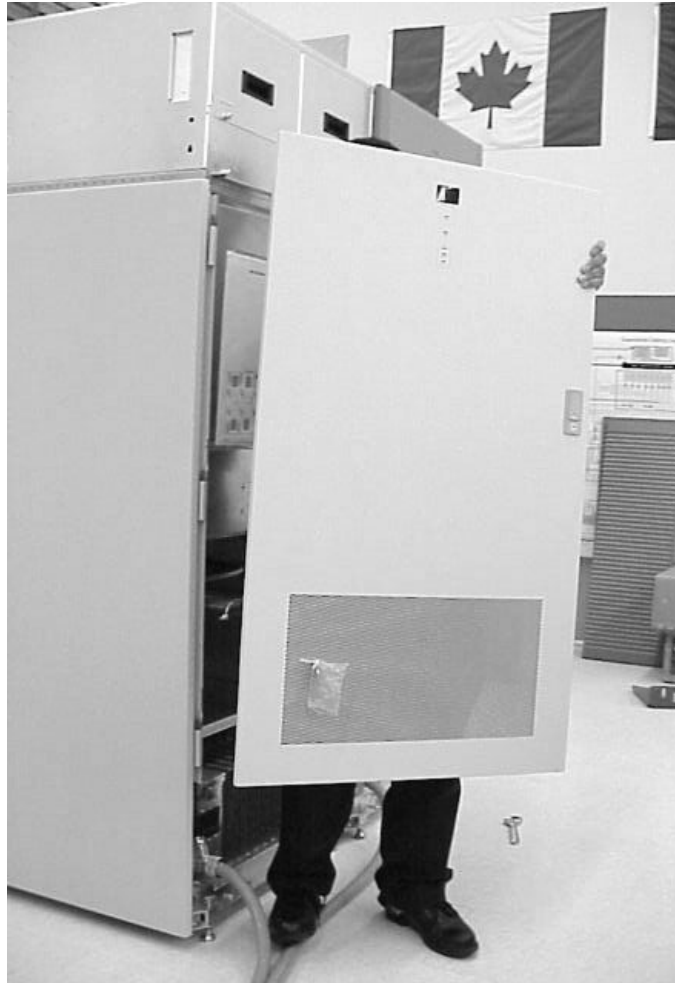

4. Remove the rear door hinge plate by removing the six T20 Torx screws as shown in Figure 2-5.

Figure 2-5 **Removing Door Hinge Screws**



Step 4. Remove the T20 screws that secure the side skin(s) to be removed. Figure 2-6 shows the left side skin (as viewed from the front of the server).

Figure 2-6 **Removing the Side Skin Screws**

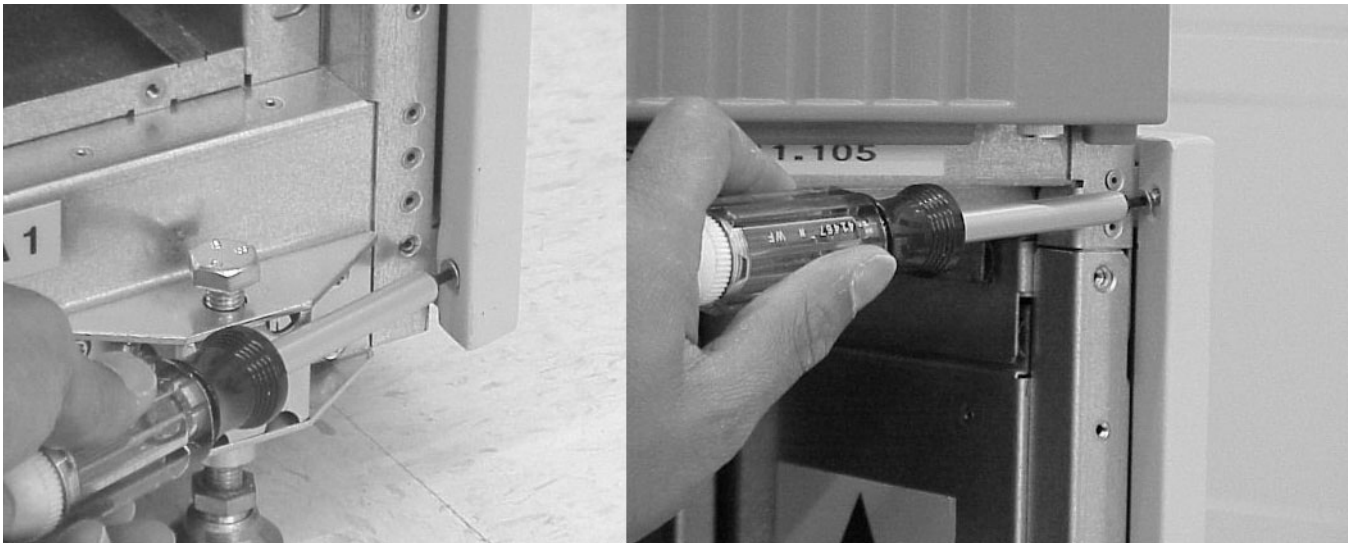

Step 5. Remove the appropriate side skin by sliding them out toward the back of the cabinet. See Figure 2-7.

Figure 2-7 **Superdome Side Skin Removal**



Installing New Cable Exit Panel

- Step 1.** Remove old cable exit panel(s) on the appropriate side(s) of the Superdome cabinet. Both the left and right exit panels are shown in Figure 2-8. The exit panels are secured with two T20 Torx screws.

Figure 2-8 Removing Old Exit Panels

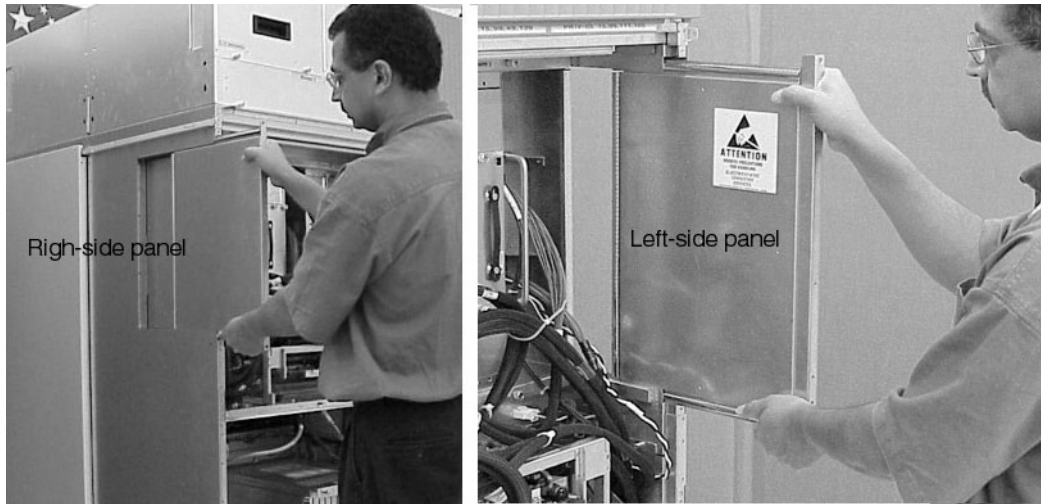

- Step 2.** Remove the rear door latch from the old blank EMI panel and install it on the new panel.
- Step 3.** Install the new cable exit panels into the appropriate side(s) of the panel. Secure the panel(s) with two T20 Torx screws. See Figure 2-9.

Figure 2-9 Installing New Cable Exit Panels

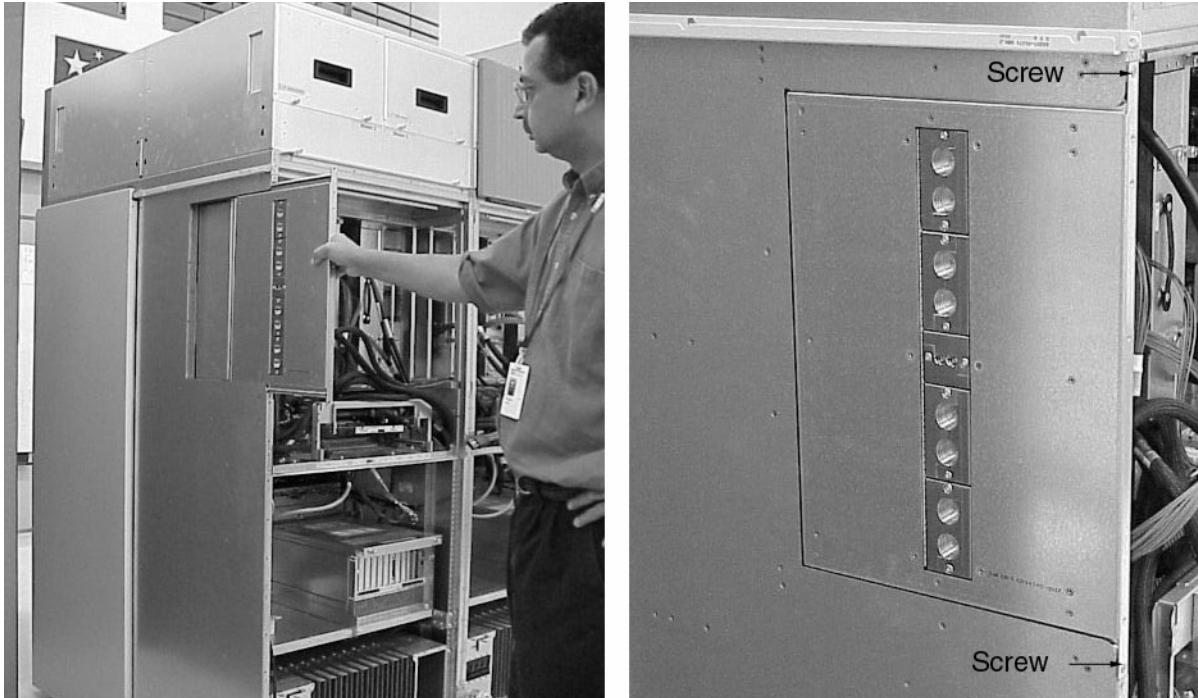

Installing the New Side Skins

The new side skin(s) must be installed after the new exit panel(s). The Superdome side skin required for an IOX has a cutout that lines up with the cable feed clamps (R-PECs and U-PECS) in the new cable exit panel(s).

Step 1. Locate the new side skin(s), remove it from the cardboard shipping container and remove the protective plastic wrap from the new side skin(s).

NOTE The skins may be shipped with blanks installed in the cutouts.

Figure 2-10 New Side Skin As Received

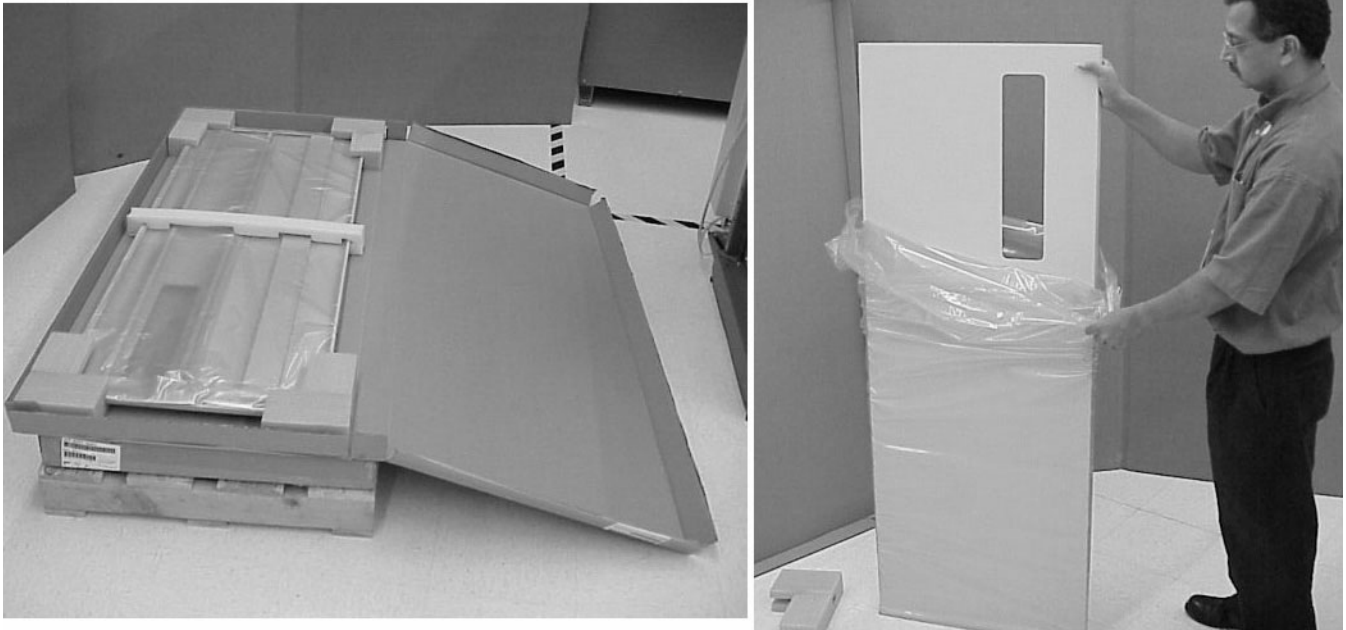

Step 2. Install the new side skin(s) in place of the old one(s). Install two T20 Torx screws at the top and bottom of the back of the side skin to secure.

Figure 2-11 **Installing New Side Skin**



Finishing the Upgrade

Once the new exit panels are installed, the rear door (if removed), and blower bezel(s) must be reinstalled onto the Superdome cabinet(s). Perform the preceding procedures in reverse.

Reinstalling the Rear Door

NOTE Perform the following steps only if you had to remove the rear door to the Superdome cabinet.

Step 1. Attach the door-hinge assembly using the six T20 Torx screws.

Step 2. Carefully lift the rear door and slide it over and onto the three hinge pins.

Figure 2-12 Reinstalling the Rear Door



Step 3. Reattach the rear display panel connector.

Step 4. Reattach the ground wire.

Reinstalling the Blower Bezels

Attach the blower bezels removed earlier.

3 Installing the IOX

Unpacking the IOX

Before Unpacking the IOX

The IOX is delivered in two boxes. The small box contains the IOX kick panel, cable exit panel, and other miscellaneous pieces.

There are two tilt indicators on the large IOX box. Insure that they indicate that the box has not been subjected to damaging forces.

Figure 3-1 Tilt Indicator

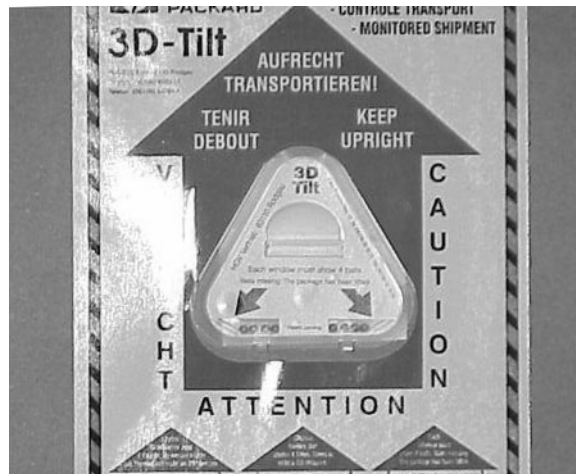

Unpacking the IOX

To unpack and set up the IOX into position, perform the following steps:

- Step 1.** Using a lift jack, roll the IOX to an convenient area, preferably near its permanent location.
The front of the cabinet is lowered onto the ramps first.

WARNING Do not use a fork lift to move the IOX cabinet.

- Step 2.** Cut the polystrap bands around the shipping container.

WARNING Wear protective glasses while cutting the plastic bands around the shipping container. These bands are under tension. When cut, they can spring back and cause serious eye injury.

Figure 3-2 **Removing the Shipping Straps**

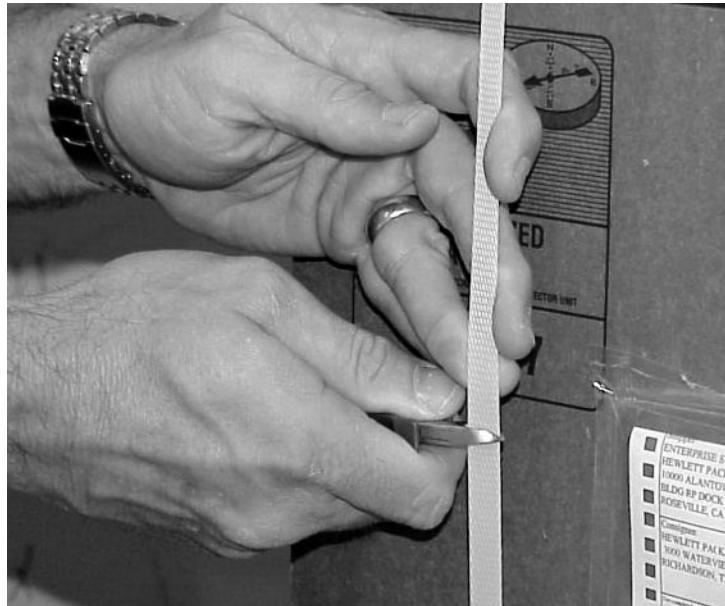

Step 3. Lift the cardboard top cap from the shipping box.

Figure 3-3 **Removing the Cardboard**

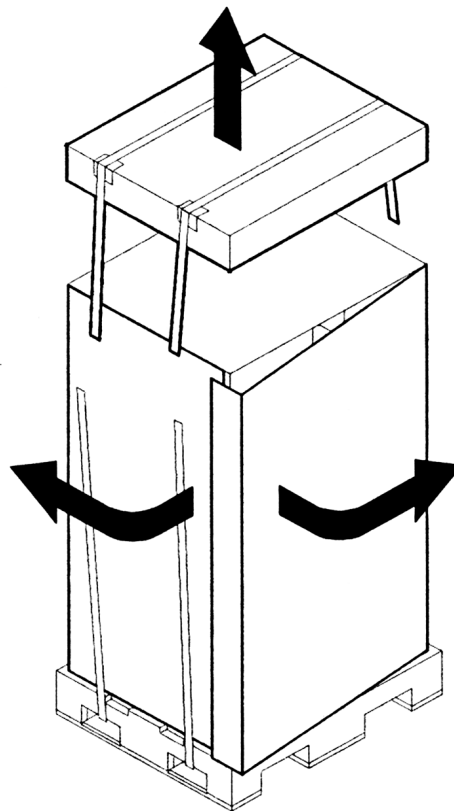

Step 4. Remove the packing materials.

Step 5. Remove the cardboard box from the IOX using a box knife. See Figure 3-4.

Figure 3-4 Cutting the Packing Tape



Step 6. Remove the bolt holding down the ramps and remove the ramps. See Figure 3-5.

Figure 3-5 Removing the Bolt Holding the Ramps

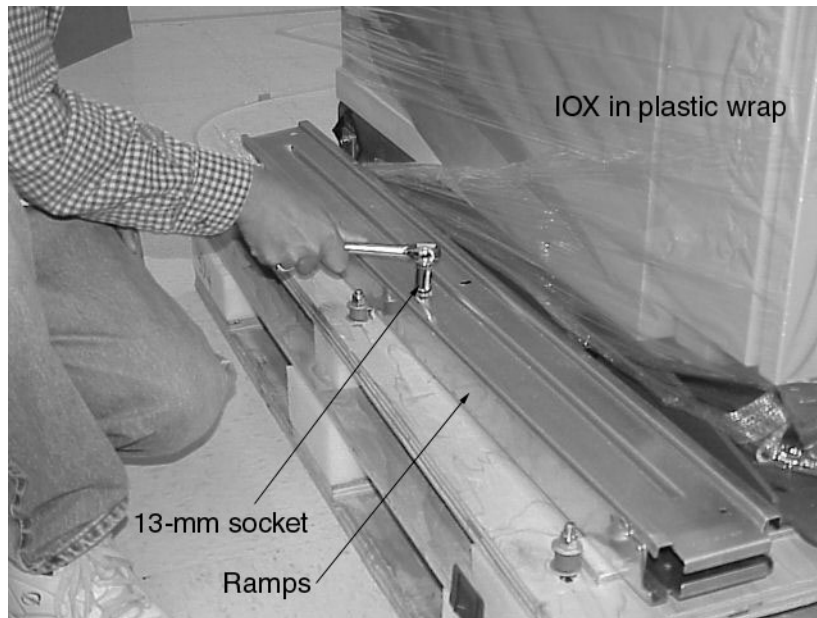

Step 7. Remove the anti-tip stabilizer feet located under the front of the IOX by loosening the two shipping bolts using a 13-mm socket. This task may require a ratchet extension as the bolts are approximately 14 inches from the edge of the IOX. See Figure 3-6, Figure 3-7, and Figure 3-8.

Figure 3-6 **Location of Anti-Tip Stabilizer Feet**

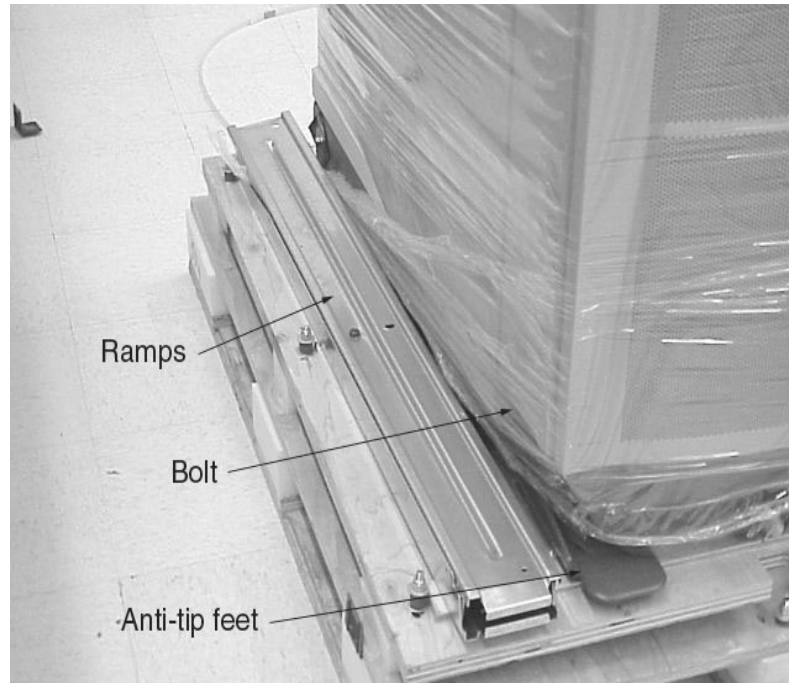

Figure 3-7 **Using a Ratchet Extension to Loosen the Bolts Holding Anti-Tip Stabilizer Feet**

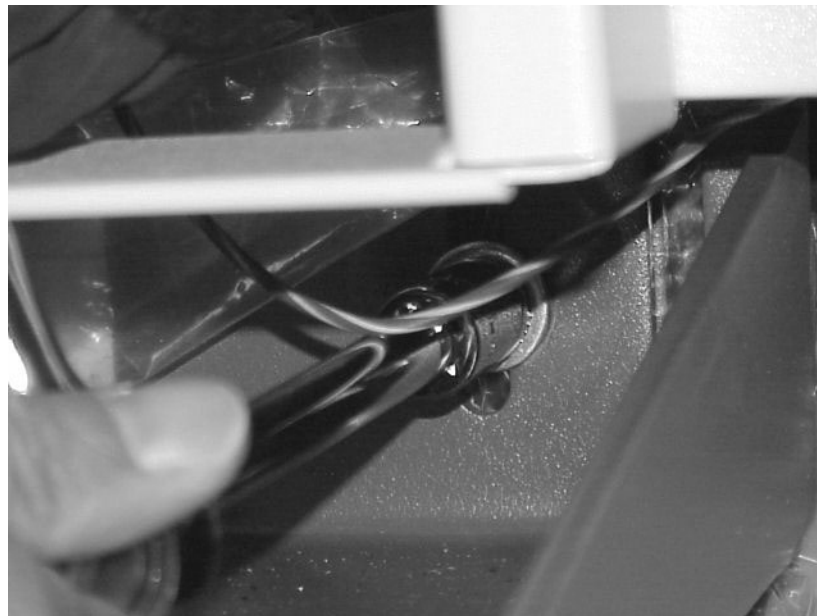

Figure 3-8 **Removing the Anti-Tip Stabilizer Feet**



Step 8. Remove the power cord from the cabinet back rail by cutting the green tie-wraps on the rail and removing the green VELCRO ties holding the cord.

NOTE Green tie-wraps and green VELCRO ties secure the cables during shipment. They should be removed when installing the IOX. The black tie-wraps and VELCRO ties should not be removed.

Figure 3-9 **Removing the Power Cord**

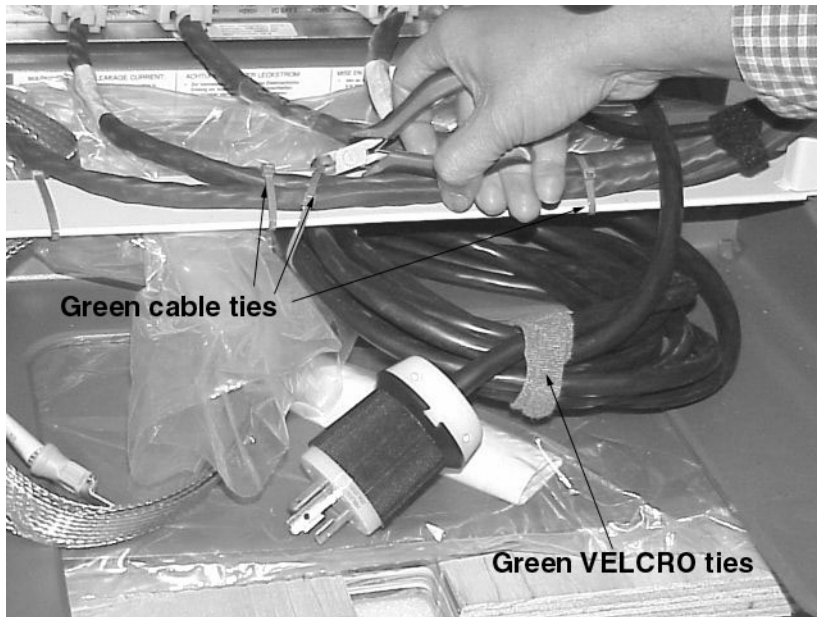

Step 9. Using the 13-mm socket and ratchet wrench, remove the four pallet securing brackets. Two are located toward the front of the cabinet, and two are located at the rear behind the anti-tip stabilizer feet. The anti-tip stabilizer feet must be removed (and are removed in Step 7.) before these two pallet bolts can be removed. See Figure 3-10.

Figure 3-10 **Pallet Securing Brackets**

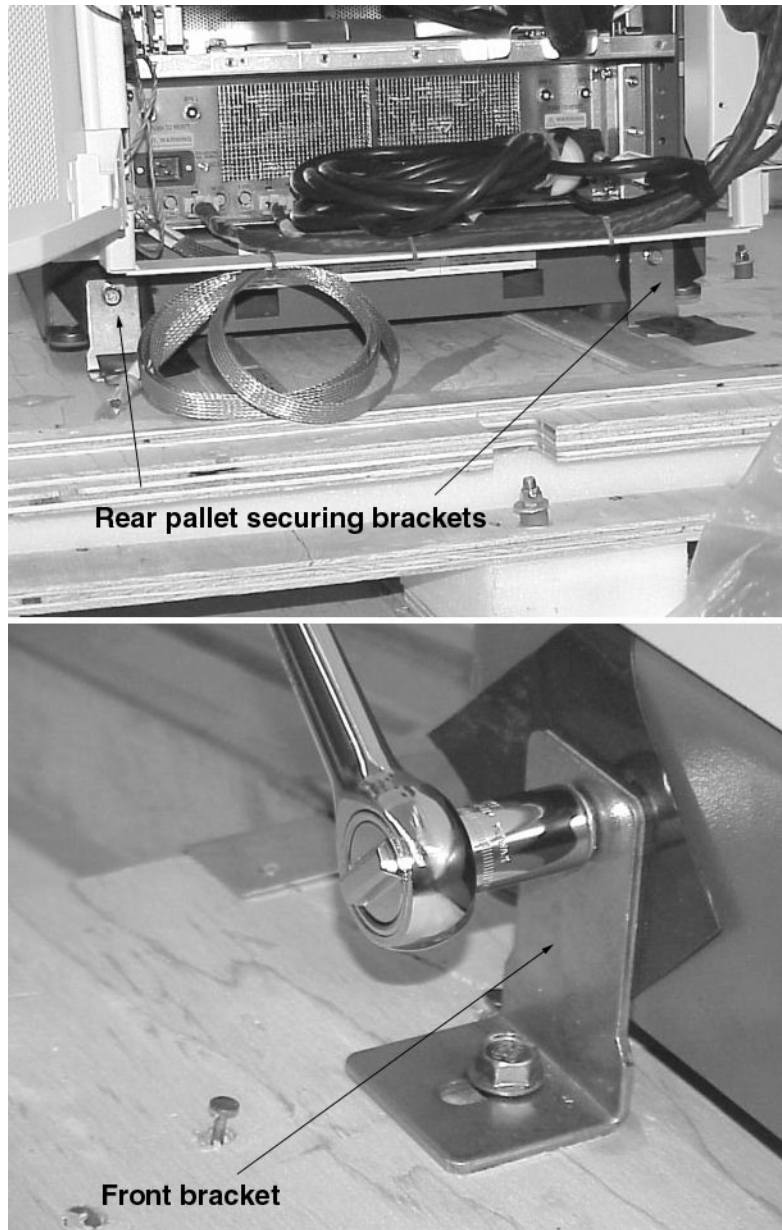

Moving the IOX into Position

After removing the packing materials, the pallet securing bolts, and the ramps, you are now ready to move the IOX into position.

Step 1. Place the ramps onto the pallet.

There are two slots in the wooden pallet into which the hooked ends of the ramps fit. The hooks and slots keep the ramps from sliding off the pallet while rolling the cabinet down the ramps.

Figure 3-11 **Placing the Ramps**

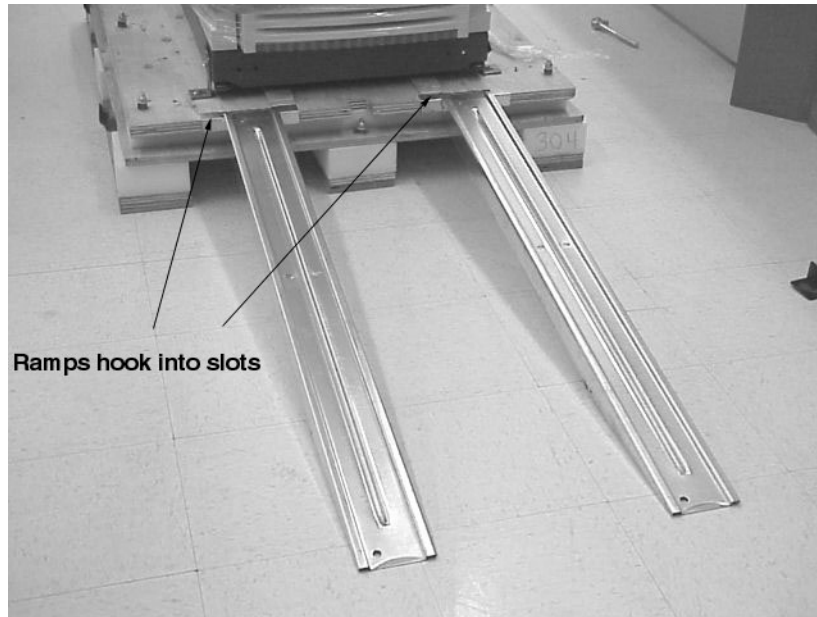

Step 2. Remove the middle side panels to expose the rack channels and rails. This allows you to grip firmly the IOX as you roll it down the ramps.

Figure 3-12 Remove Side Panels Before Rolling Cabinet onto Ramps



Figure 3-13 Exposing the Channels and Rails

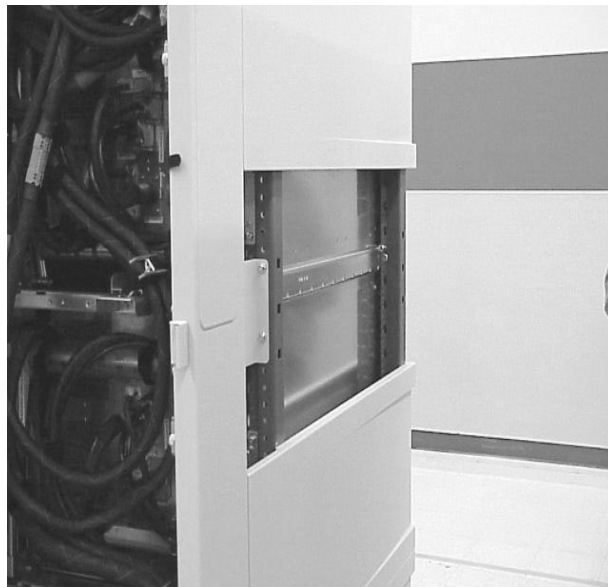

Step 3. While holding one of the side rails with one hand and the cabinet front with the other, carefully roll the IOX cabinet down the ramps. Two people are required to do this task. See Figure 3-14.

WARNING Do not stand in front of the IOX while it is rolled down the ramps. It can fall on and injure you.

WARNING Do not attempt to move the Superdome cabinet, either packed or unpacked, up or down an incline of more than 15°.

CAUTION Make sure that the leveling feet on the rack are raised before you roll the rack down the ramp and any time you roll the rack on the casters.

CAUTION Use two people when rolling the cabinet down the ramps.

Step 4. Roll the IOX cabinet into place.

Figure 3-14 Rolling the IOX Down the Ramps



Step 5. Properly dispose of all packing materials.

Aligning the IOX Cabinet to the Superdome Cabinet

The IOX can be installed on either side of a Superdome server. Both the Superdome and the IOX cabinets, therefore, have pass-through cutouts that are covered by panels. Located on each side of the rack, these cutouts allow the IOX to be installed on either side of the Superdome cabinet. Figure 3-15 shows the panel removed in a Superdome server. REO cables are routed horizontally from an ICE in the IOX to a Cell board in the Superdome cabinet through the cutouts. The cutouts are aligned with each other in both cabinets.

Figure 3-15 Superdome Cable Pass-through Cutout

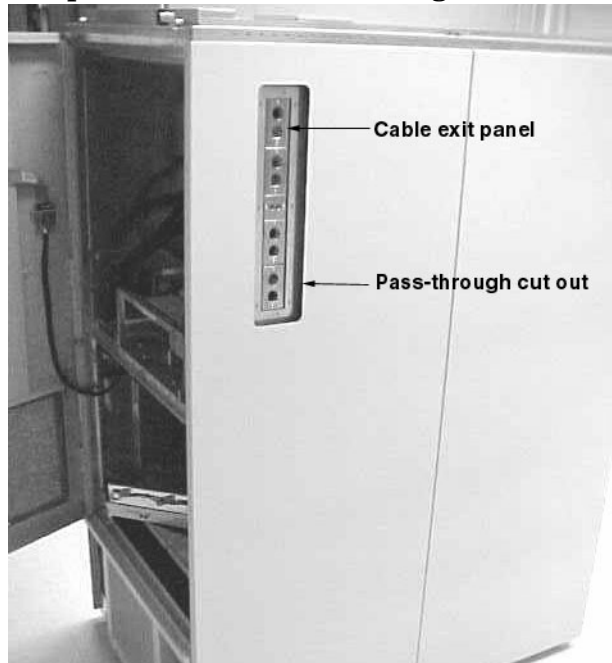

NOTE There are no mechanical features that hold the superdome and IOX in alignment.

Figure 3-16 IOX Cable Pass-through Cutouts



Step 1. Remove the cable exit cutout blank panel on the side of the Superdome server that is to be next to the IOX.

Figure 3-17 Superdome Exit Cutout Blank Panel



Step 2. Remove the IOX exit panel blank on the side that is to be next to the Superdome server.

Figure 3-18 IOX Exit Cutout Blank Panel



Step 3. Install the IOX so that the front surface of the IOX side panel is in line with the front surface of the superdome side skin, as shown in Figure 3-19.

Figure 3-19 IOX Cabinet Alignment (Front)

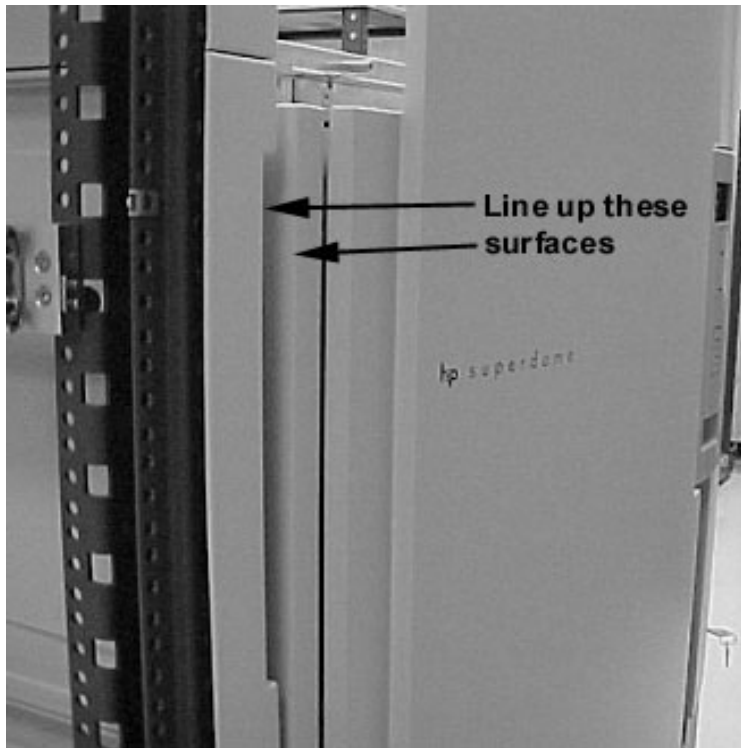

Step 4. Ensure that the cutout in the IOX rack extension panel aligns with the Superdome cable exit panel as shown in Figure 3-20.

Figure 3-20 IOX Cabinet Alignment (Rear)



Securing the Cabinet

Step 1. Once in position, secure and stabilize the cabinet using the leveling feet at the corners of the base using the 13-mm open-end wrench. Remove the shipping band before adjusting the leveling foot.

Figure 3-21 Leveling Feet

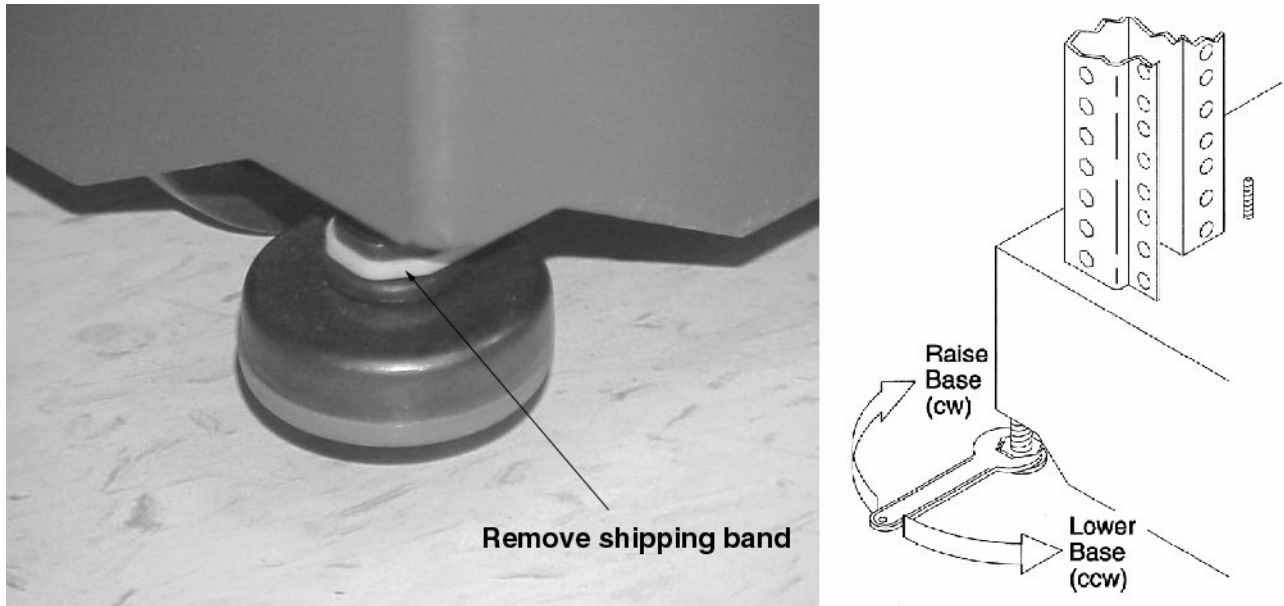

Step 2. Attach the anti-tip panels at the front and rear of the cabinet using the 13-mm socket and ratchet wrench.

Before attaching the front foot, be sure to mount the kick panel mounting bar as shown in Figure 3-22. The same screws that secure the anti-tip panel pass through the kick panel mounting bar.

Figure 3-22 Attaching the Anti-Tip Stabilizer Feet

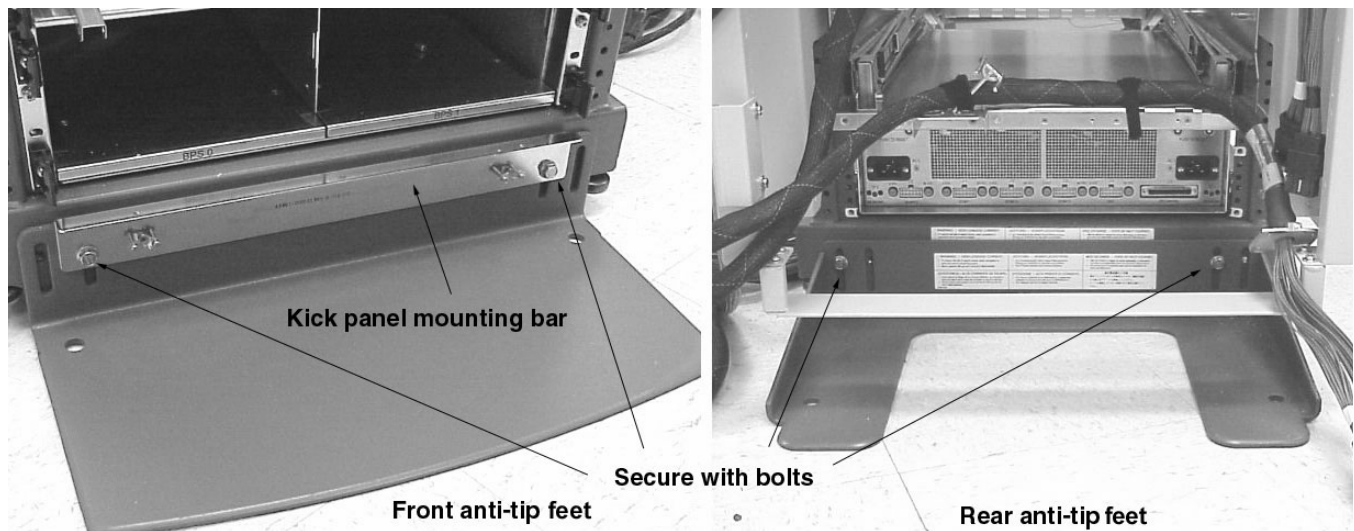

Step 3. Attach the kick panel at the base of the cabinet front as shown in Figure 3-23.

Figure 3-23 Snapping On the Kick Panel

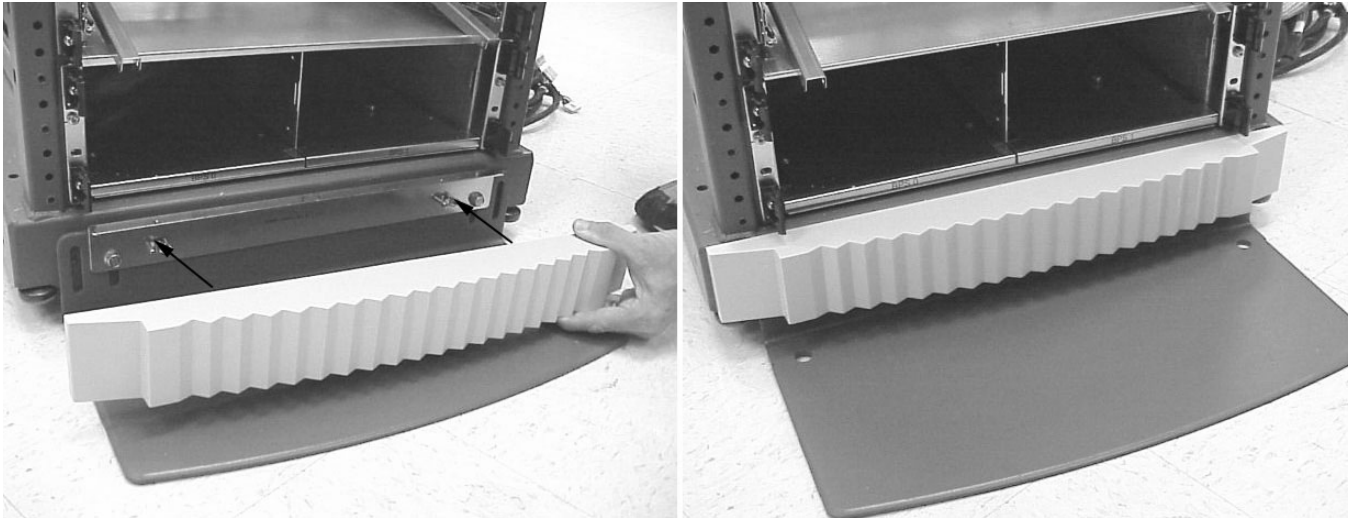

Connecting the IOX to the Superdome

Grounding the IOX to the Superdome

After the IOX has been moved into place, it has to be grounded to the Superdome next to it. Provided with the IOX is a grounding cable with lugs on both ends. The following procedure describes how to connect the grounding cable.

Step 1. Locate the grounding cable and determine which side of the rack to secure it.

Figure 3-24 IOX Grounding Strap

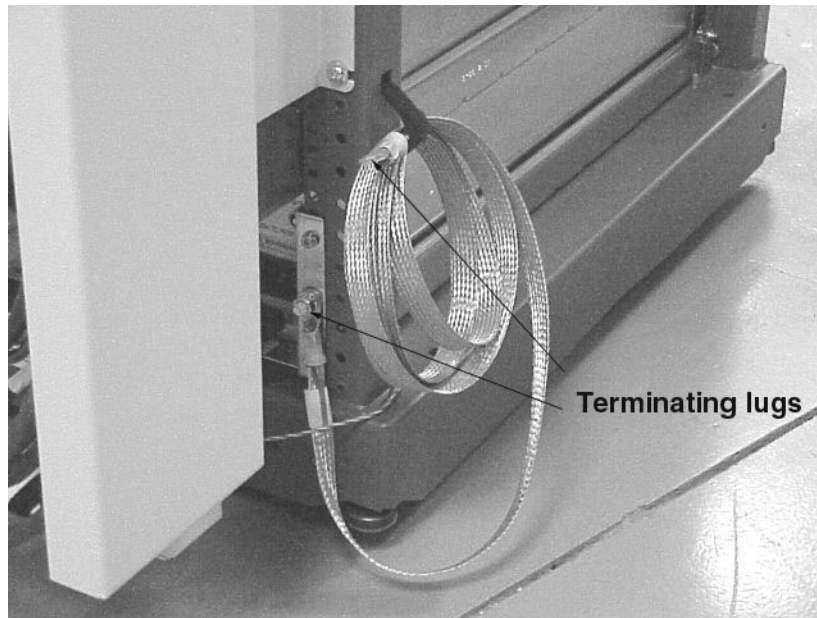

Step 2. Secure the cable to the IOX lug using the washer and nut provided.

Step 3. Secure the other end of the grounding cable to Superdome cabinet using the washer and nut provided.

There are two lugs for this in both the IOX and Superdome server: one on either side of the cabinet. Secure the cable on to the side nearest the IOX.

Figure 3-25 **Ground Studs in Superdome Cabinet**

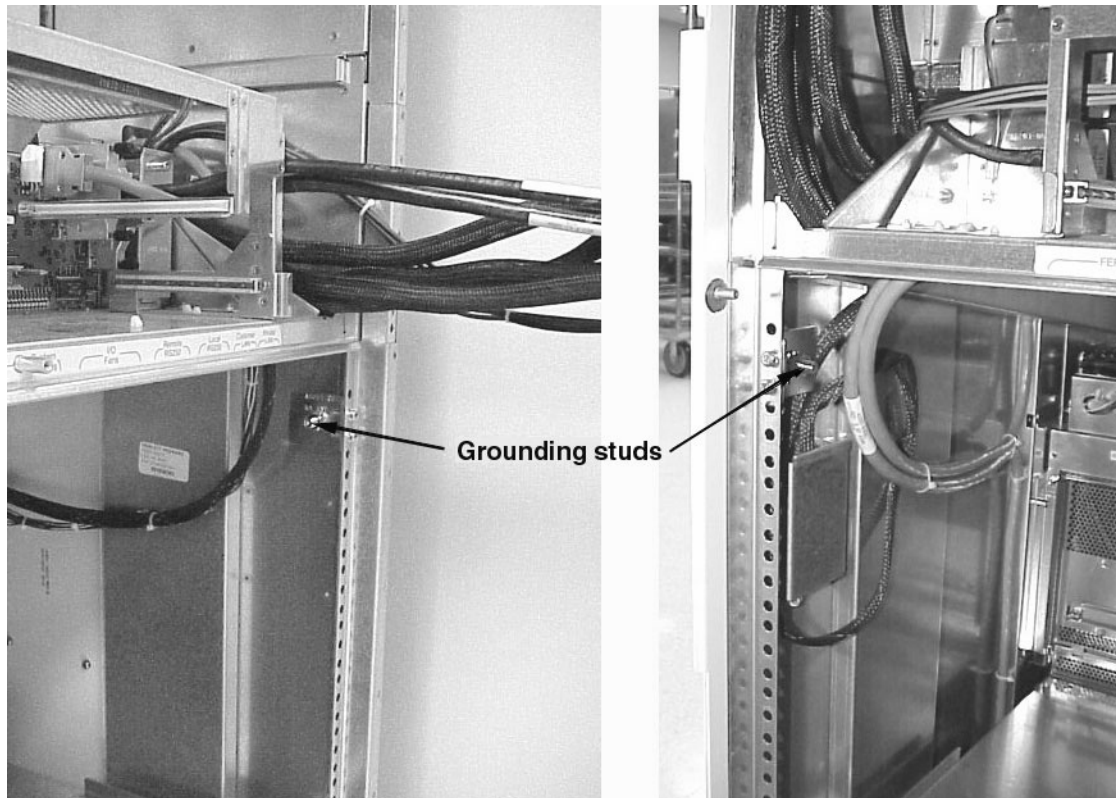

Connecting the REO and GSP Bus Cables

Overview

The IOX is shipped with all cables connected. Cables that connect to the Superdome server (REO and GPS bus) are coiled and attached to either back cabinet rails or the side rails or both with green tie wraps and/or green VELCRO cable ties.

IMPORTANT Do not remove any black or grey cable ties.

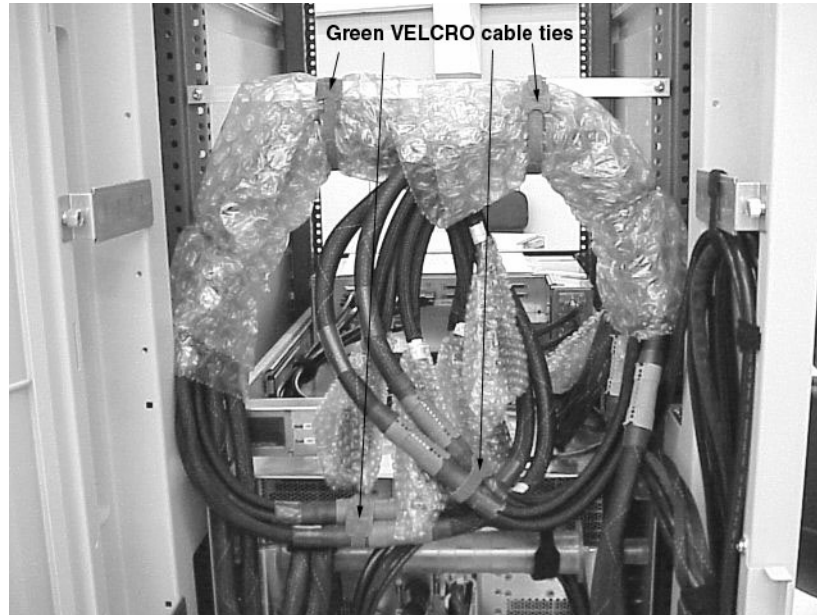
Figure 3-26 Remove and Discard Green VELCRO Ties

There are optional brackets for retaining cables in the cable routing channel at the rear of the extension and additional holes for attaching cable ties in the routing channel.

REO cables run through one of the side bulkheads secured by cable clamps, or R-PECs, run through the cutout in the IOX side, and connect to the XUCB in the Superdome cabinet. The GSP bus cables run from the rear of the XUC, through the bulkhead secured by cable clamps, or U-PECs, into the Superdome cabinet and connect to the Superdome backplane,

The Superdome 32 Way cabinet supports two ICEs. Therefore, only one IOX cabinet is required. Figure 3-27 shows a typical arrangement of a Superdome 32 Way server and one IOX cabinet. The Superdome 64 Way server (two connected Superdome 32 Way cabinets) can have from one to four ICEs connected to it and one or two adjacent IOX cabinets. Figure 3-28 and Figure 3-29 show examples of Superdome 64 Way servers and their adjacent IOX cabinet(s).

REO and GSP bus cables runs can be “long” or “short,” depending on the IOX and server arrangement.

Examples of short REO cable runs are:

- In Figure 3-27, all cables running from the IOX to the server cabinet adjacent to it.
- In Figure 3-28, the cables from IOX cabinet 8 running to the adjacent server cabinet n. This is the “unbalanced” case.
- In Figure 3-29, the cables from IOX cabinet 8 running to the adjacent server cabinet n and the cables running from IOX cabinet 9 to server cabinet n+1. This is the “balanced” case.

Examples of long cable runs are shown in Figure 3-28 where the cables run from IOX cabinet 8 to the far server cabinet n+1 and from IOX cabinet 9 to server cabinet n.

Figure 3-27 IOX to Superdome 32 Way Connections

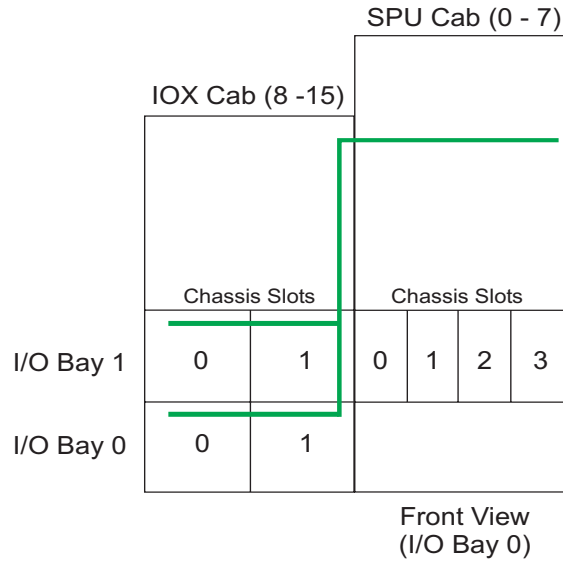
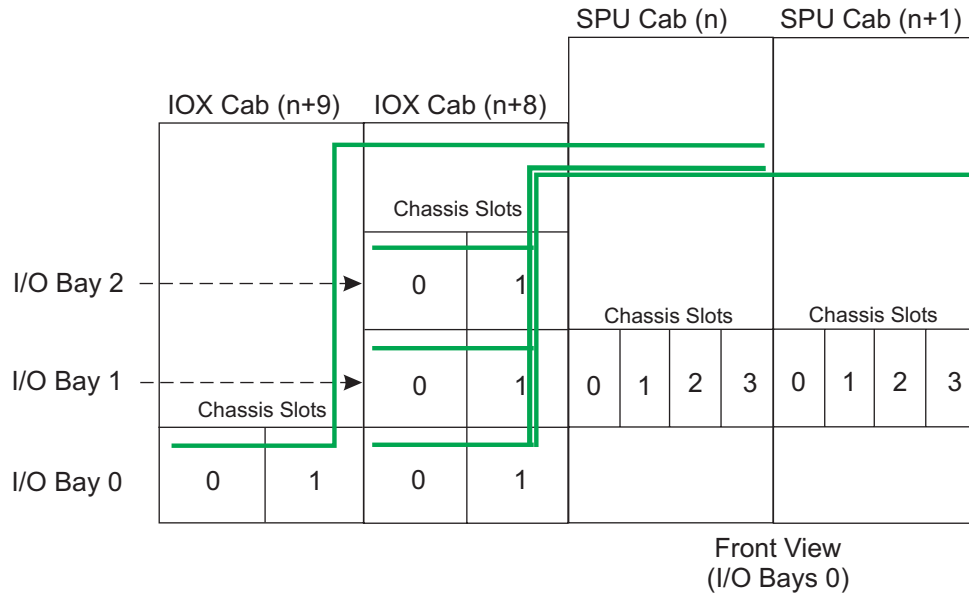
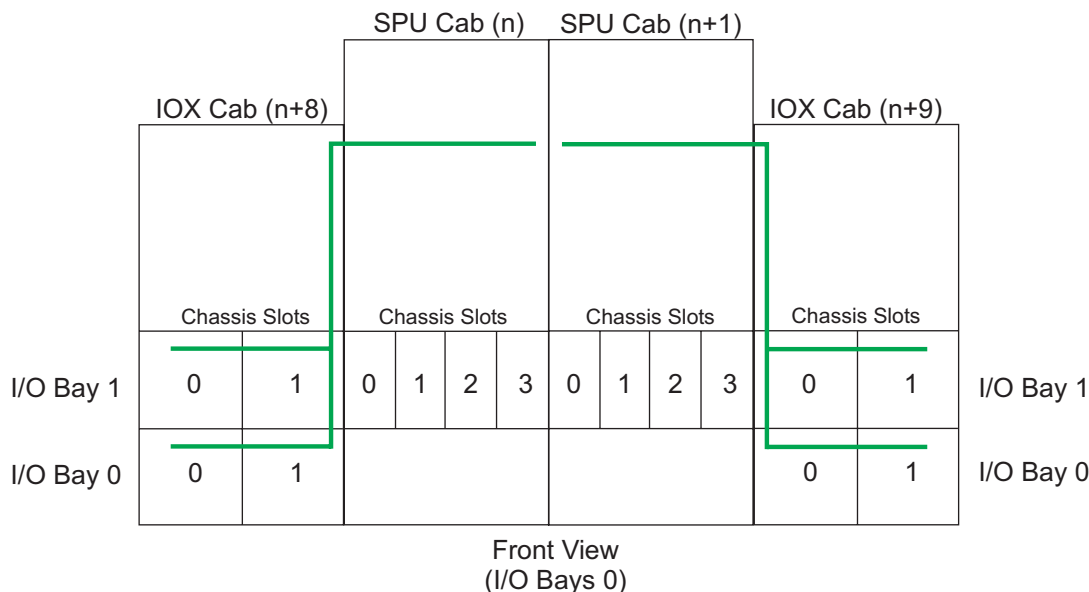

Figure 3-28 Superdome 64 Way Node with Unbalanced IOX Cabinet Configuration



60IO880a
04/11/00

Figure 3-29 Superdome 64 Way with Balanced IOX Cabinet Configuration



6010890a
 04/11/00

Connecting the REO Cables

The following procedure describes how to connect and route an REO cable between the Superdome server and the IOX. This is a generic procedure, because each configuration is different.

NOTE Insure that you understand the configuration of your particular Superdome and IOX installation.

The terminations of the REO cables are identified: CPU CABINET and IOX CABINET. Also each REO cable has two sections where the shield is exposed. Each of these sections has a plastic protector covering the shield. Before installing a REO cable, remove these protectors by pulling the perforated sections and discarding. The protection must be removed to allow electrical contact between the shield and the R-PEC. One shield section has a blue protector and the other has a green one. Use the blue section when the destination Superdome cabinet is next to the IOX. Use the green section when there is another cabinet between the IOX and the destination Superdome cabinet.

IMPORTANT Remove the protective plastic only on the appropriate shield section. Leaving the other shield section exposed can cause inadvertent shorting.

Figure 3-30 shows the blue plastic shield protectors nearest the Superdome server end, and Figure 3-31 shows the green protectors. When it is determined how far the REO cable has to run and where it passes through the Superdome bulkhead, the appropriate shield is exposed and secured to the Superdome bulkhead using an R-PEC.

There are two REO cables per ICE, and therefore REO cables are always connected in pairs. There are four R-PECs and one U-PEC in the cable exit panel. The REO cable pairs from the ICE mounted lowest should

mount and run through the bottom R-PEC in the cable exit panel. Likewise, the REO cables from the next higher ICE pass through the next higher R-PEC, and so on.

Figure 3-30 **Blue Shield Protectors**

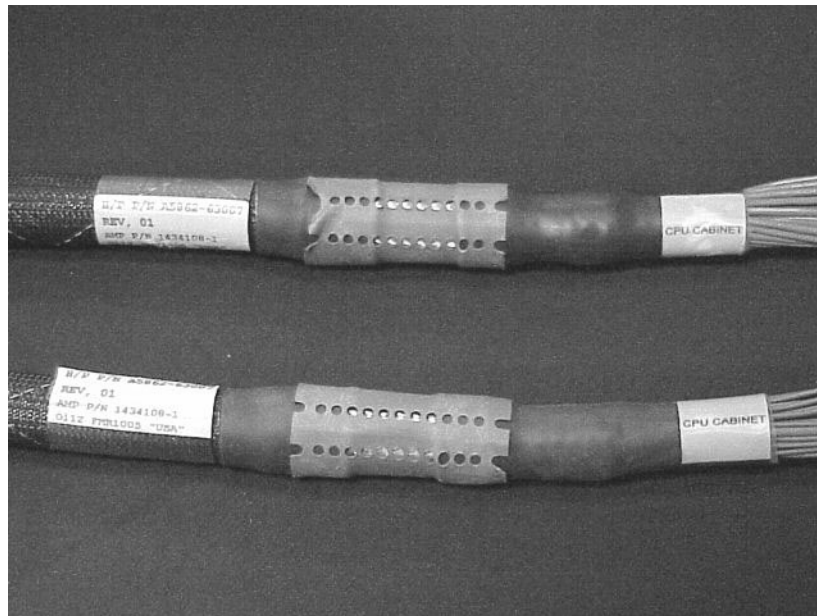
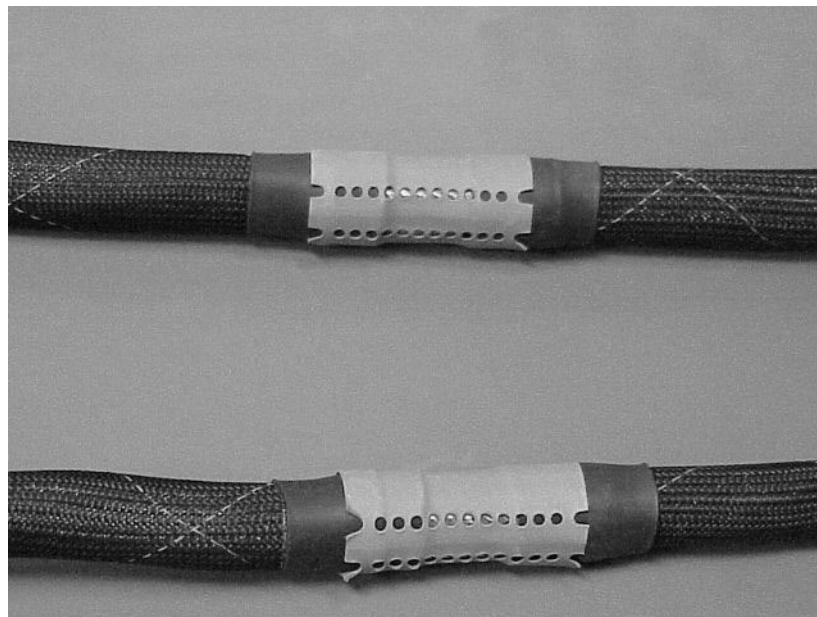

Figure 3-31 **Green Shield Protectors**



Procedure

- Step 1.** Remove the rear door on the IOX to be connected to the Superdome server by sliding it up off the hinge pins.
- Step 2.** Remove the rear door of the Superdome server.

Connecting the IOX to the Superdome

Step 3. Cut the green tie wraps and remove the green VELCRO ties holding the REO cables during shipment.

NOTE The IOX may have one, two, or three ICEs. There are two REO cables per ICE. Therefore, you may have to perform these steps on as many as three REO cable pairs.

Step 4. Remove the appropriate R-PEC from the cable exit panel by loosening the two T15 Torx screws.

The REO cable pairs from the ICE mounted lowest should mount and run through the bottom R-PEC in the cable exit panel. Likewise, the REO cables from the next higher ICE pass through the next higher R-PEC, and so on.

In Figure 3-32, the IOX is not in place for illustrative purposes.

Figure 3-32 Removing R-PEC

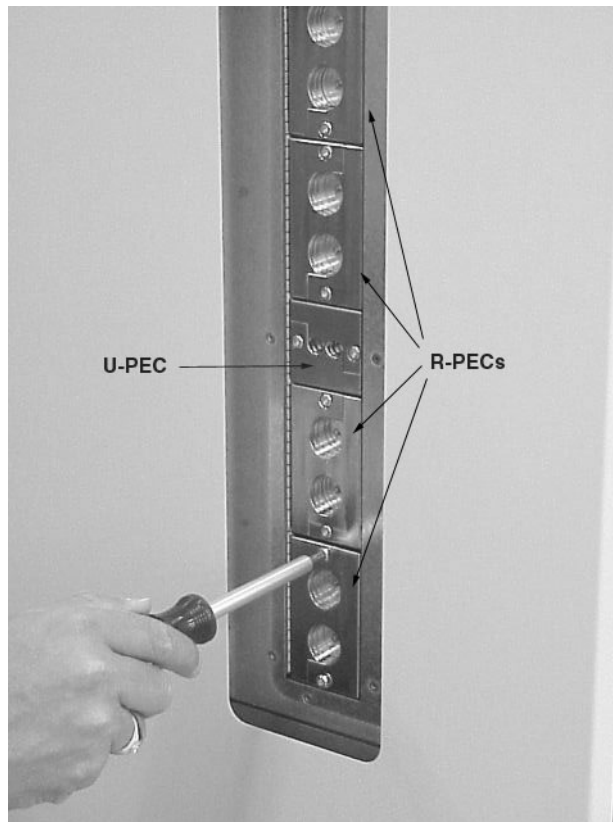

Step 5. Determine the destination in the Superdome server of the REO cable and pass the REO cable pair through the cable exit panel where the R-PEC was removed.

Figure 3-33 **Passing the REO Cable Pair Through the Superdome Cable Exit Panel**

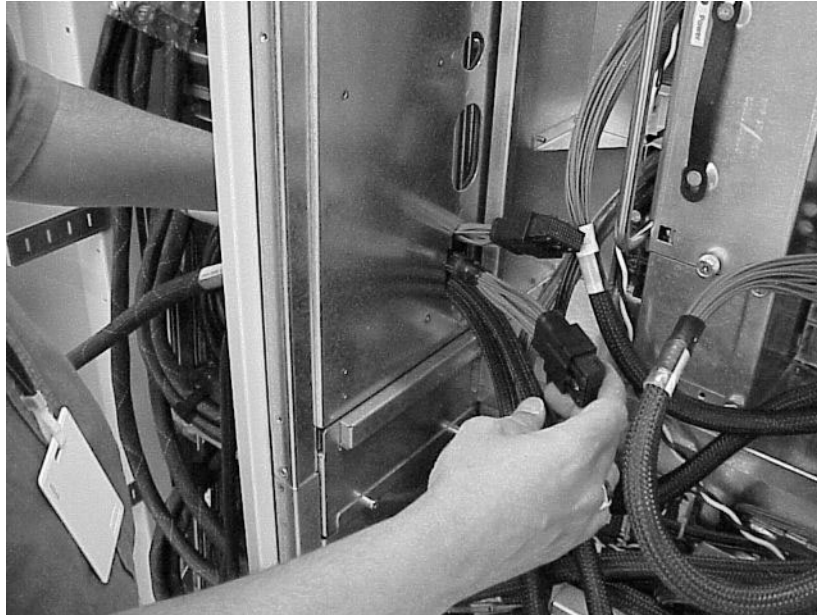

Step 6. Determine which shield protector to remove and pull the perforated section. Discard the plastic. The shield is exposed after the protector is removed. See Figure 3-34.

IMPORTANT Remove the protective plastic only on the appropriate shield section. Leaving the other shield section exposed can cause inadvertent shorting.

Figure 3-34 **REO Shield Exposed**



Connecting the IOX to the Superdome

Step 7. Separate the halves of an R-PEC. You will have to loosen the screws in the blanks to facilitate their removal.

The R-PEC attaches to the exposed shield in the REO cable. There are two halves that fasten together with three T15 Torx screws. REO cables are always attached in pairs. Each R-PEC, therefore, has two holes. Unused R-PECs must have blanks in the holes.

IMPORTANT The R-PEC blanks must occupy all unused holes.

Figure 3-35 **REO R-PEC**

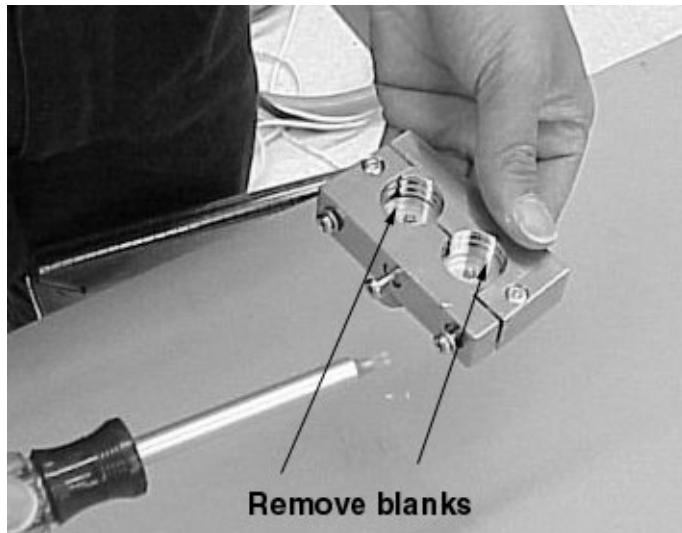

Step 8. Attach the REO cable R-PEC to the cable at the exposed shield using two T15 Torx screws. See Figure 3-36.

Figure 3-36 **Installing the R-PEC**

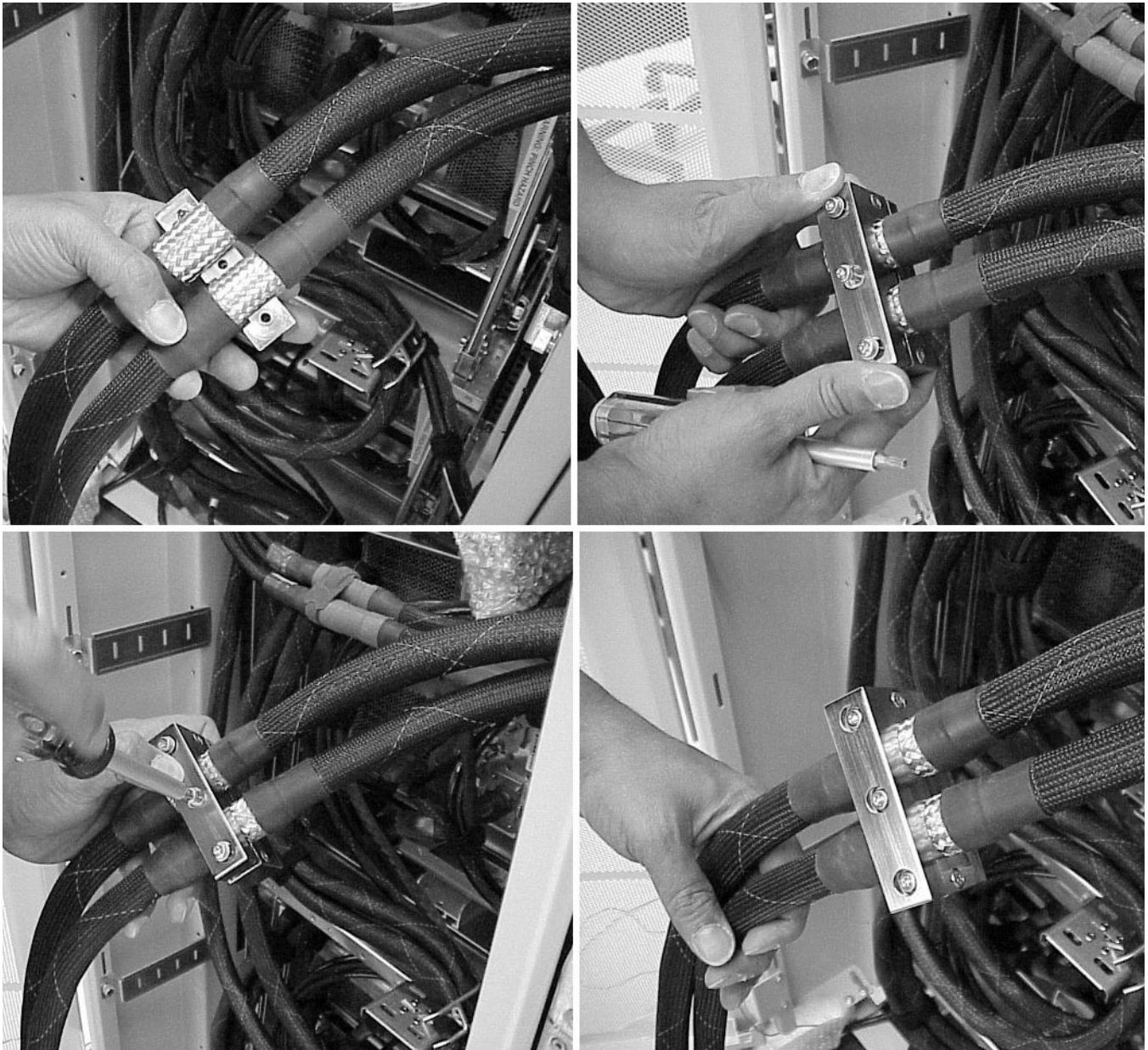

Step 9. Install the R-PEC in the appropriate location on the cable exit panel using two T20 Torx screws.

IMPORTANT The three screws need to be tightened in the following sequence: middle first, then one side, and then the other side. Tighten each screw one turn at a time, repeating the sequence until all three are hand tight. This tightens the clamp onto the cable without warping.

Figure 3-37 REO Cable Pair Mounted in R-PEC and Installed in Cable Exit Panel



- Step 10.** Connect the REO cable to the appropriate Cell board connector in the Superdome server.
- Step 11.** Repeat Step 4. through Step 10. for each REO cable pair.

Figure 3-38 Typical REO Cable Locations

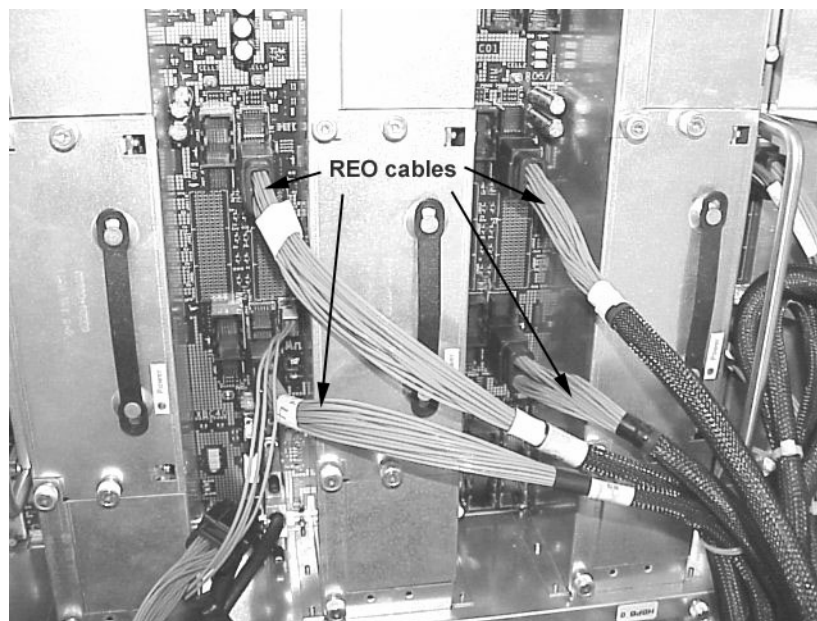

Connecting the GSP Bus Cables

The GSP bus cables are very similar to the REO cables, in that they have two sections where the shield is exposed. They are routed the same way as the REO cables and are secured to the Superdome cable exit panel with a U-PEC (as opposed to the R-PEC used for the REO cables). Each shield section is protected with plastic covers. You remove these covers as described in the REO cable section, “Connecting the REO Cables” on page 62.

There is only one GSP bus cable per IOX, which runs from the XUC in the IOX to the backplane of the Superdome server.

Procedure

Step 1. Locate the GSP bus cable and remove the green tie wraps and/or green VELCRO cable ties.

Figure 3-39 Identifying the GSP Bus Cable



Step 2. Remove the GSP bus U-PEC from the cable exit panel by removing the two T15 Torx screws. See figure Figure 3-40. In the figure the IOX is not in place for illustrative purposes.

Figure 3-40 Removing the GSP Bus U-PEC



Step 3. Pass the GSP bus cable through the cable exit panel.

Figure 3-41 **Passing the GSP Bus Cable Through the Cable Exit Panel**



Step 4. Determine which shield protector to remove and pull the perforated section. Discard the plastic.

NOTE Remove the blue shield protector when the destination server is next to the IOX. Remove the green shield protector when the destination server is not next to it, as with a Superdome 64 Way server.

IMPORTANT Remove the protective plastic only on the appropriate shield section. Leaving the other shield section exposed can cause inadvertent shorting.

Figure 3-42 GSP Bus Cable Shield Protector

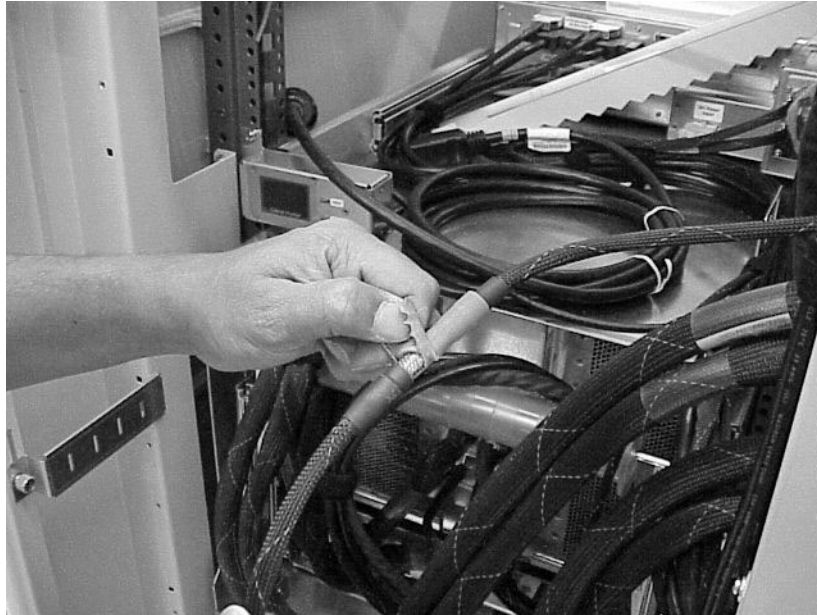

Step 5. Separate the U-PEC into halves by removing the two T15 Torx screws.

The U-PEC has two cable holes that are filled with a blank in each hole. There is normally only one hole used, because there is only one GSP bus cable. Therefore the blank must remain in the other hole. Loosen the screw in the blanks to facilitate its removal.

IMPORTANT The U-PEC blanks must occupy all unused holes.

Figure 3-43 U-PEC

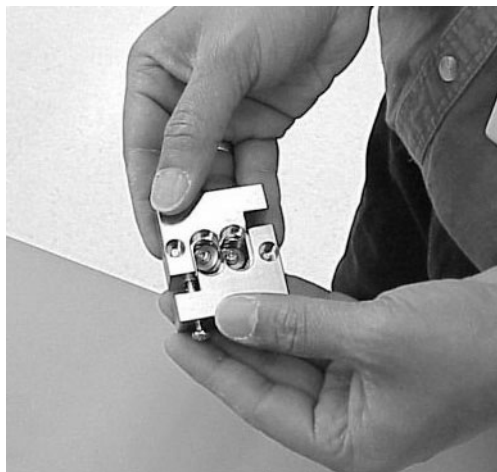

Step 6. Attach the U-PEC to the GSP bus cable where the shield is exposed and tighten the two T15 Torx screws. Tighten the blank screws to seat the gasket.

NOTE The U-PEC blanks are not round, so the correct orientation must be observed. They must be aligned properly to be able to close and tighten the U-PEC.

Figure 3-44 Proper Orientation of U-PEC Blank

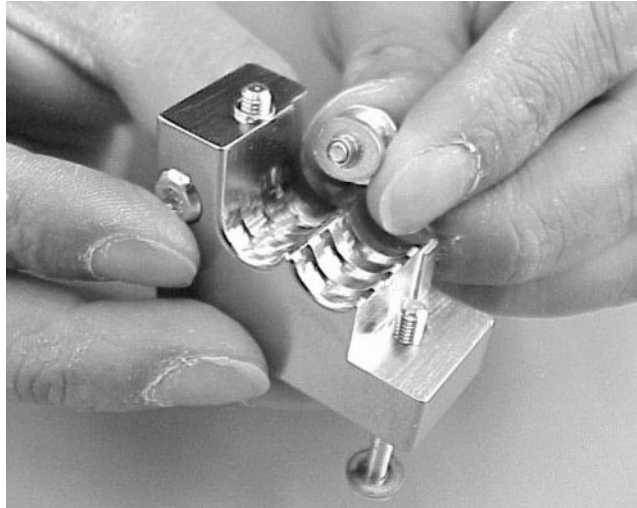
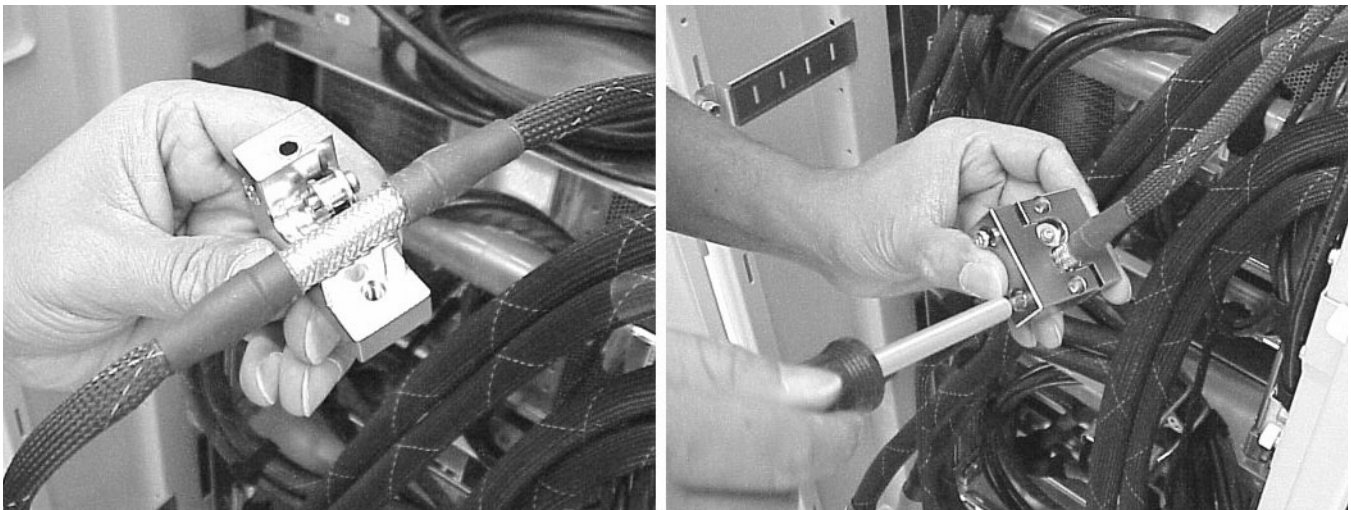

Figure 3-45 Installing the GSP Bus U-PEC



Step 7. Attach the U-PEC to the cable exit panel.

Step 8. Connect the GSP bus cable to the Superdome server.

You must determine where the GSP bus terminates in the Superdome. shows a typical installation.

Figure 3-46 Typical GSP Bus Installation in the Superdome Server

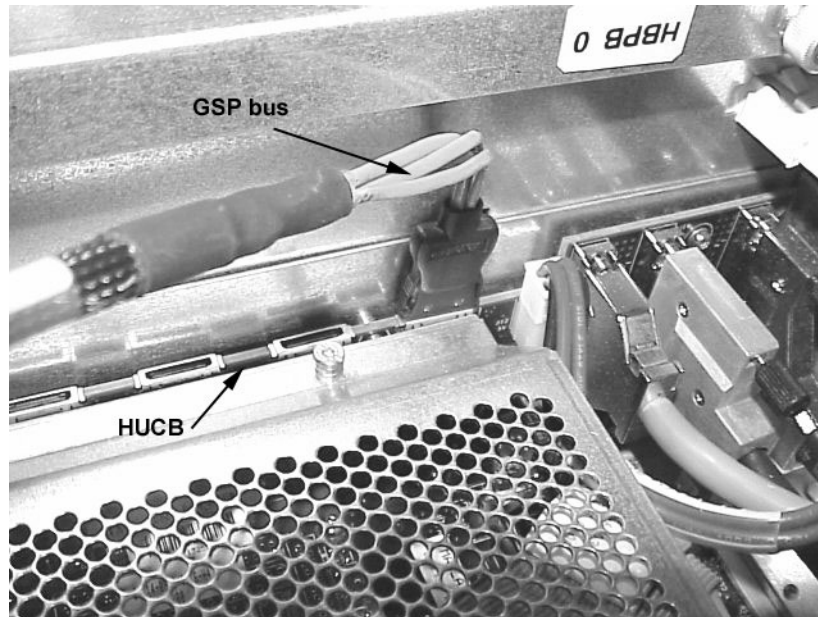

Step 9. When finished installing the REO and GSP bus cables, reinstall the rear doors on both the IOX and Superdome sever(s).

Figure 3-47 REO and GSP Bus Cables Passing into Superdome

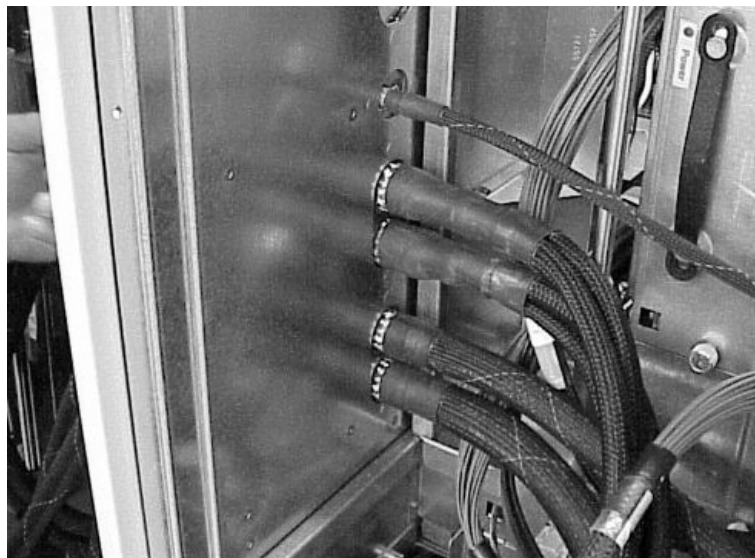

Setting the Cabinet Number

After installing the IOX, the cabinet number must be set. The IOX cabinet is either 8 or 9. to set the cabinet number:

- Step 1.** Remove the XUC bezel by holding it with both hands on the handles on the side of the bezel and pulling forward.

This exposes the XUC front panel. There are two latch screws on either side of the panel.

Figure 3-48 XUC Cosmetic Bezel



- Step 2.** With a slotted screwdriver, turn the latch screws counter-clockwise.

Figure 3-49 XUC Front Panel Latch Screws

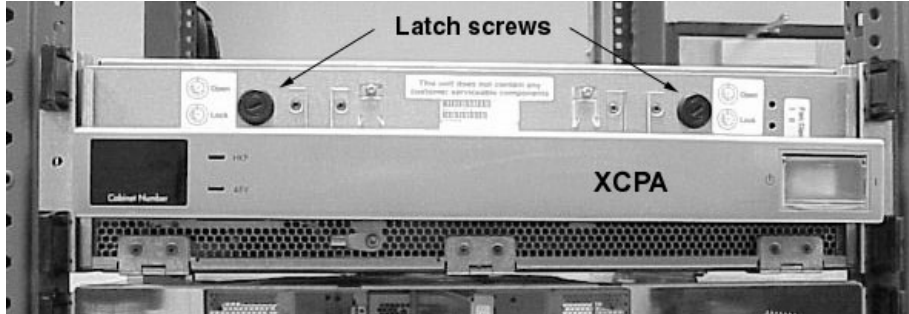

- Step 3.** Slide the XCPA panel up until it latches.
- Step 4.** Drop down the EMI panel. This allows you access to the CLU board.
- Step 5.** Locate the Cabinet Number switch and set it to the appropriate number.

Figure 3-50 **Cabinet Number Switch**

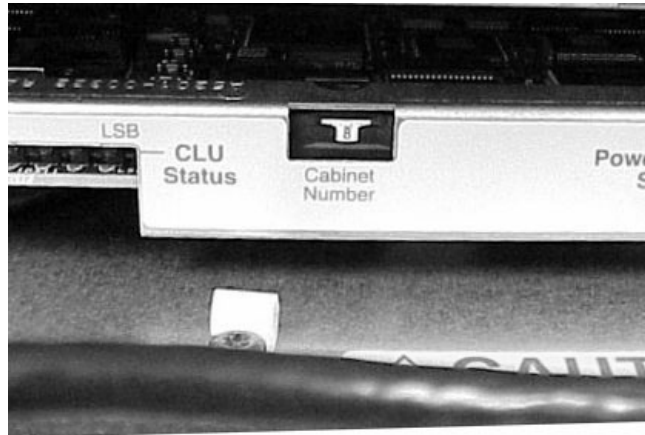

IMPORTANT Never have two IOX cabinets the same number. IOX cabinets can either be 8 or 9. If you have two IOX cabinets for a Superdome 64 Way server, then the numbers needs to be 8, then 9, respectively.

- Step 6.** Close and lock the XUC front panel. The magnetic latch holds the panel in the up position. Lower the CPA until it latches.
- Step 7.** Turn the latch screws CW one-quarter of a turn to tighten.
- Step 8.** Replace the XUC bezel.

4 Cabling

The IOX is shipped normally with all cables already connected, but because there may be some installations that require additional cabling (as for I/O and ICE upgrades) or may have to be recabled in part or entirely, this section covers how IOX cables are installed and managed.

Cable Management

The IOX provides a large amount of additional I/O for the Superdome systems. The number and weight of the cables within the IOX is large. Cable management hardware is provided at several points in the ICE.

- A wire former (or “potato masher”) provides strain relief for external I/O cables at the front of the I/O chassis. The cables are tied to this former.
- The cables are routed to the back of the ICE in a space between the I/O chassis and the ICE tray. At the back of the ICE tray, these external cables are secured to a cable bundle bracket at the rear of the ICE tray. See Figure 4-1.
- The roller at the apex of the cable management system provides strain relief and controls the bend radius of the cables. It also folds them into a compact space. Most of the service loop required to extend the shelf is implemented by routing the cables over the roller cable management arm assembly.
- Additional service loop is obtained by looping the cable bundle off the roller in a “C” shape. A special “teebar” bracket mounted at the rear of the ICE provides strain relief. This bracket assembly clamps the bundle to prevent cables from slipping down and service loop being lost.
- After exiting the ICE, the cables are routed down channels in the sides of the rear cabinet extensions and held in place with channel brackets. In addition to the channel brackets there are rectangular holes in the channel for securing cable ties. Square holes are located along the channel for snapping in cable tie anchors. Tie wraps may be looped through these anchors.
- Internal cables coming from the back of the ICE are secured to the strain relief arm. See Figure 4-1
- The REO and clock cables are routed through an EMI enclosure and connected to the XMIOB. REO and clock cable shield termination is accomplished by the cable ferrule/EMI Level 2 interface.
- All other interconnect cable connections are done at the ICE rear bulkhead.

Figure 4-1 Cable Management Mechanism

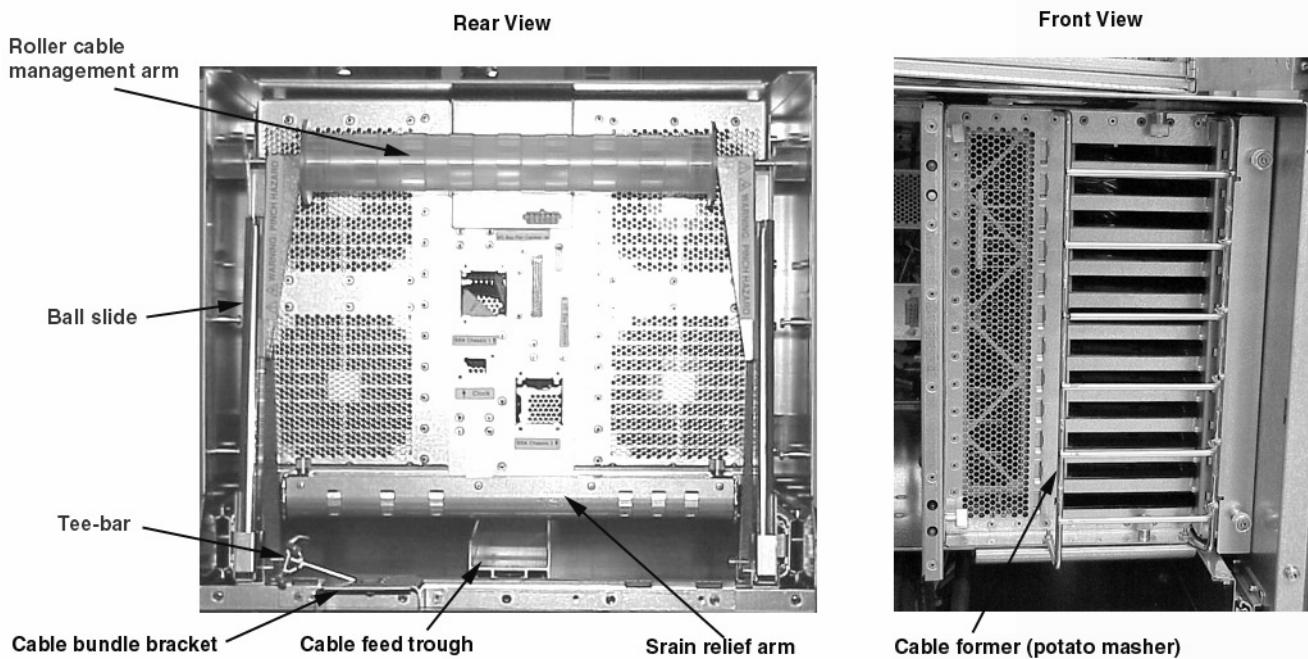

Routing the Cables

Routing the cables is a significant task in the installation process. It is important not only for the immediate need of completing the installation, but efficient cable routing is important when future service calls are made. Neatness counts. The most efficient use of space is to route cables so that they are not crossed or tangled.

Use the procedures in the following sections as guidelines to route cables out of the IOX cabinet to the Superdome cabinet.

Routing the ICE Cables

Normally, the REO, clock, and GSP bus cables are not bundled with the I/O cable (but not in all cases), because they are more “permanent.” By keeping the I/O cable separate, it is easier to add or remove I/O cables.

Routing the I/O Cables

Each I/O cable bundle should be routed off of the ICEs in alternating fashion. For example, the cable bundle in the bottom ICE may exit to the right. The bundle in the middle ICE should then exit to the left. And the bundle in the top ICE should then exit to the right. This method helps distribute the I/O bundles more evenly. The cable bundle brackets can be mounted on either side of the ICE. See Figure 4-3.

Under and between the I/O chassis is a cable routing trough shown in Figure 4-2. The trough provides a clear path from the front of the ICE to the rear, allowing the cable to be routed without getting caught or snagged on exiting cables. The cable puller is stored under the cable trough.

Figure 4-2 Cable Routing Trough

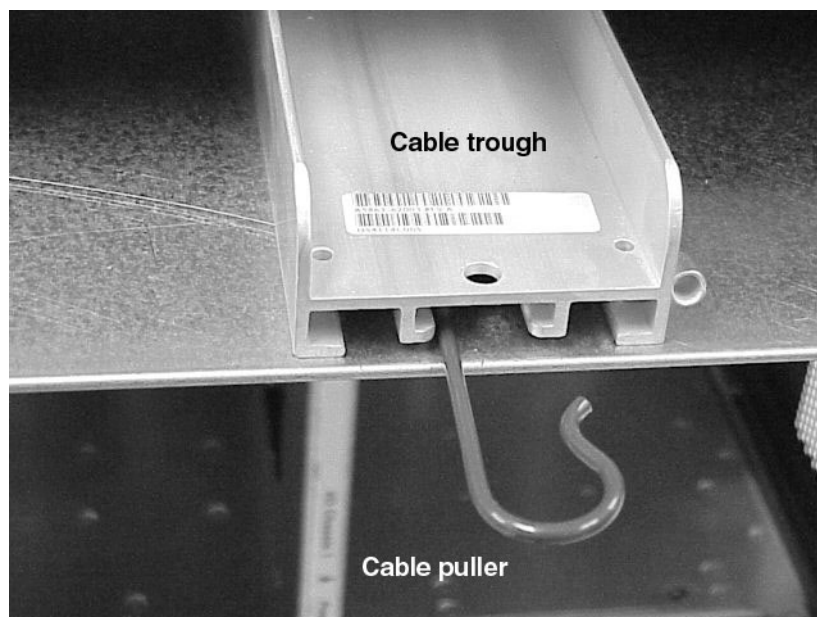
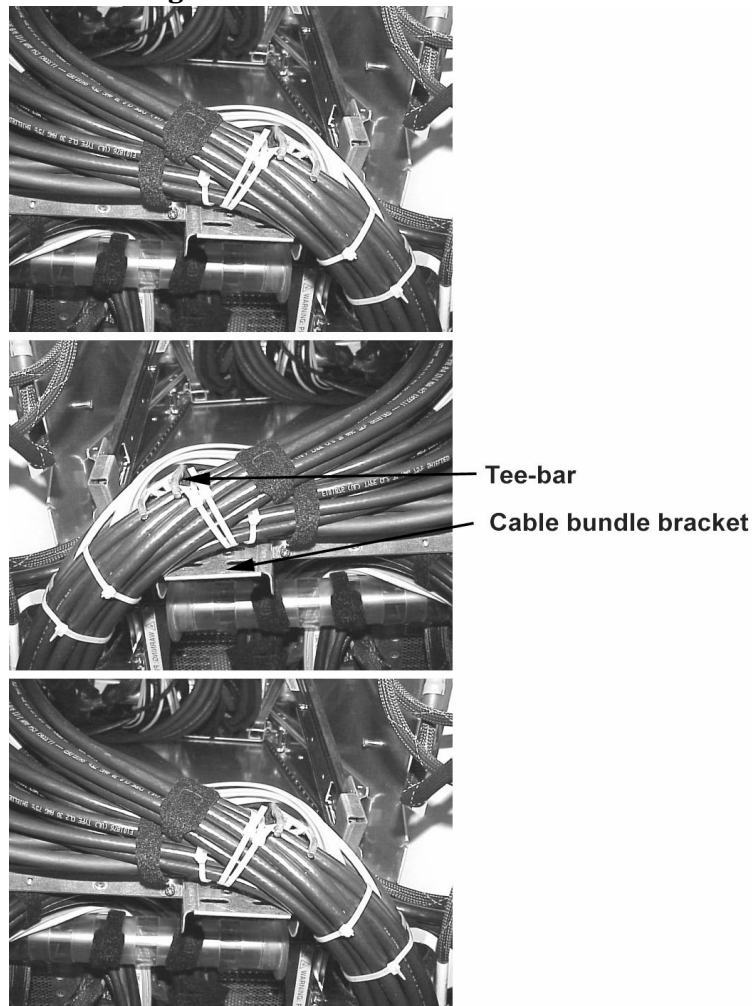
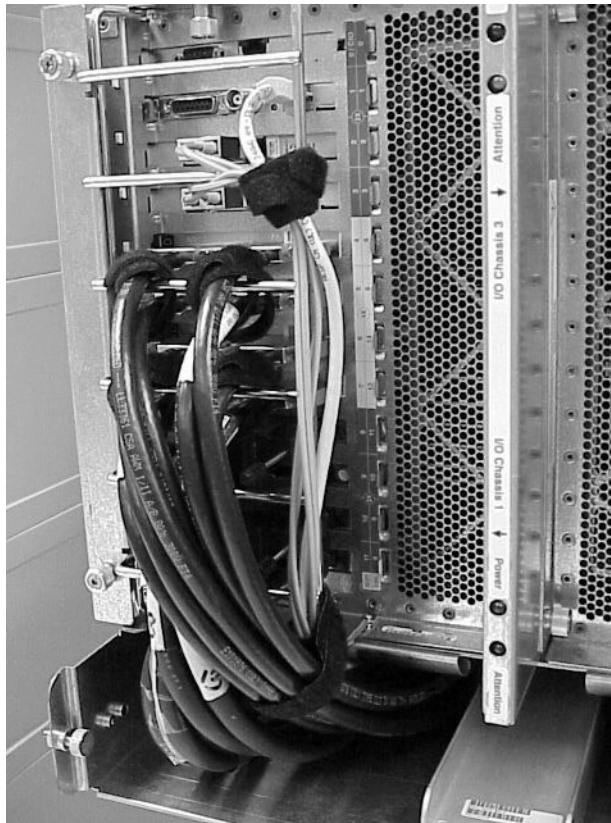

Figure 4-3 Alternating the I/O Cable Bundles



Step 1. For every PCI controller in the I/O chassis, route each cable from the back of the IOX, into the cable routing trough under the I/O chassis, through the cable groomer (also know as “potato masher”) (See Figure 4-4), and connect it to the appropriate PCI controller.

Figure 4-4 I/O Cables Connected to PCI Controllers



- Step 2.** Feed the cable from the back over the roller cable management arm (see Figure 4-1) to the base of the tray.
- Step 3.** Catch the cable with the cable puller tool and pull the cable through the cable trough to the front of the tray.
- Step 4.** From the front of the tray, pull the cable out of the trough into the tray area.
- Step 5.** Feed the cable through the potato masher and plug it into the appropriate PCI controller connector.
- Step 6.** Secure the cable to the potato masher with cable ties.
- Step 7.** Secure the cables to the roller management arm.
- Step 8.** When all I/O cables have been routed to the front of the PCI chassis and secured to the potato masher, neatly bundle them using tie wraps. Secure the to the cable bundle bracket using the tee-bar and cable ties. See Figure 4-5. Use VELCRO ties to bundle cables.

Figure 4-5 **Securing the Bundles to Teebars**

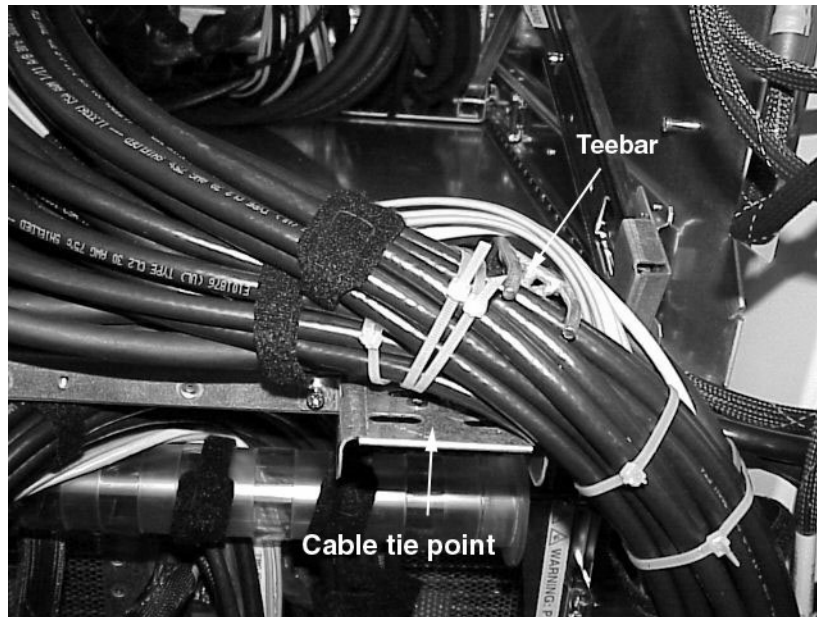

Step 9. Use channel brackets, tie slots, and tie-wrap anchors to secure cables that run along the rack channels.

Figure 4-6 **IOX Channel Bracket**

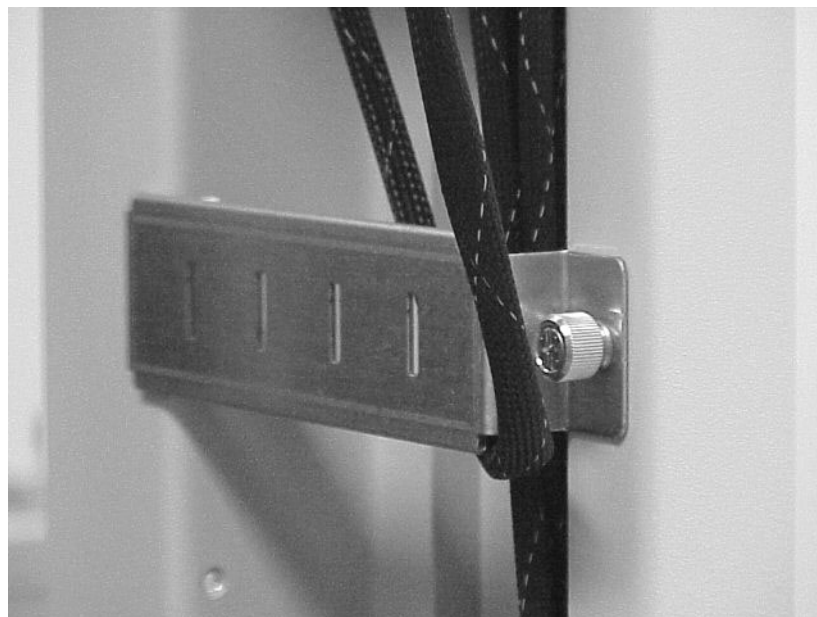

Routing the Rear ICE Cables

The rear ICE cables include:

- SBA (or REO)
- Clock
- Utilities
- Fan control
- DC Power

Step 1. Run all the cables listed above over the roller management arm.

Step 2. Insure that all cables have sufficient service loop.

Step 3. Secure each cable to the roller management arm with VELCOR cable ties.

Step 4. Secure the cables to the strain relief arm with VELCRO ties.

Step 5. Determine how each cable will run from the ICE tray to its destination and secure them appropriately. Figure 4-7 shows the rear ICE cables secured to the cable management hardware at the back of the ICE.

Figure 4-7 **Securing REO Cables**

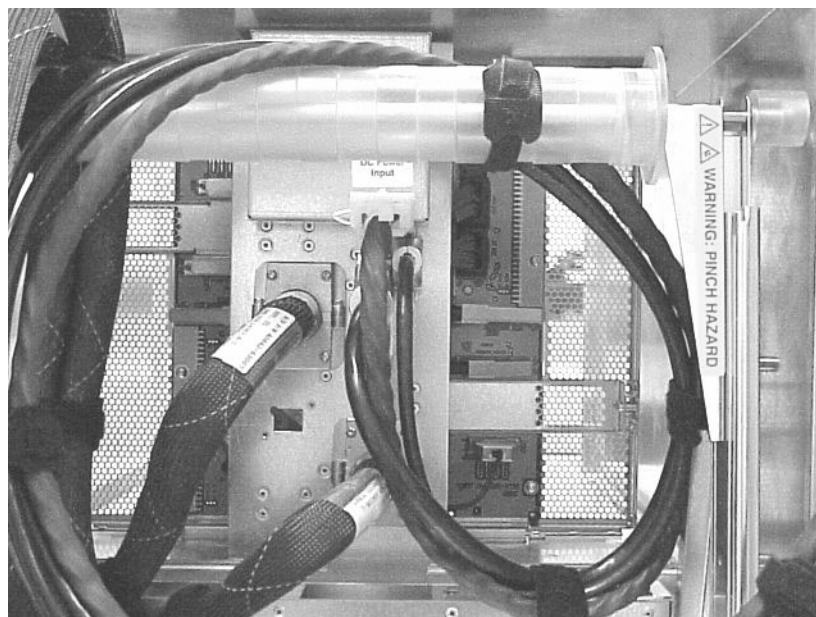

Routing the XUC Cables

Cables connected to the XUC are:

- ICE 0/1 clocks
- ICE 2 clock (not all IOXs have three ICEs)
- GSP bus
- ICE 0,1,2 utilities

Routing the Cables

- Fan control for ICE 0, 1, and 2
- XUC DC power
- XPC control
- Rear display module

Figure 4-8 shows the connectors on the XUC.

Figure 4-9 shows a typical configuration for the XUC.

Step 1. Bundle all cables running to and from the XUC using tie wraps and/or VELCRO cable ties.

Step 2. Run the cables down through the rack channels securing them to the IOX channel brackets using tie wraps or VELCRO ties.

Figure 4-8 XUC Connectors

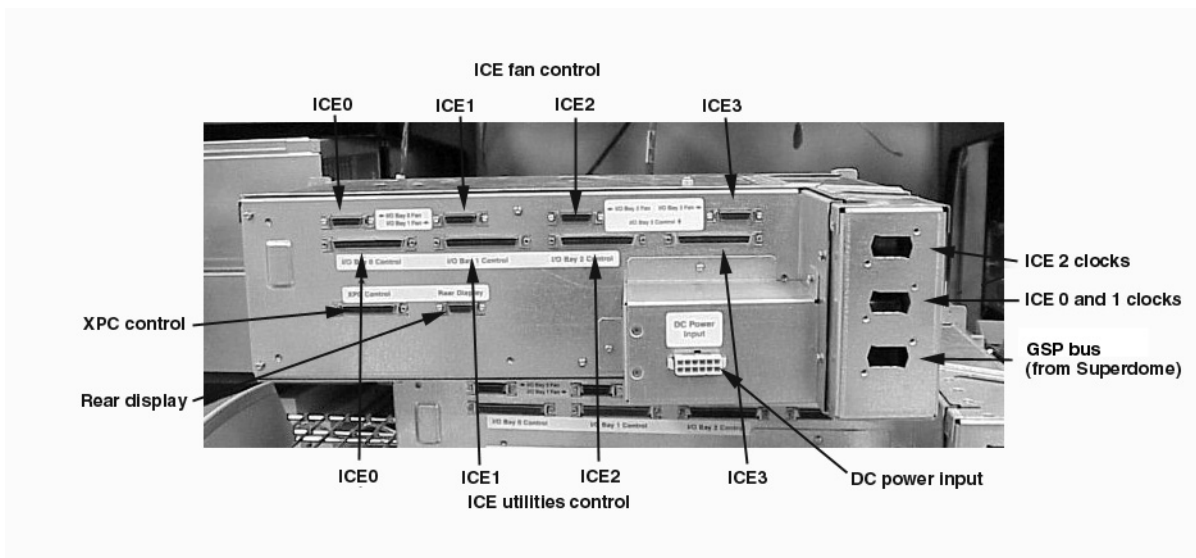
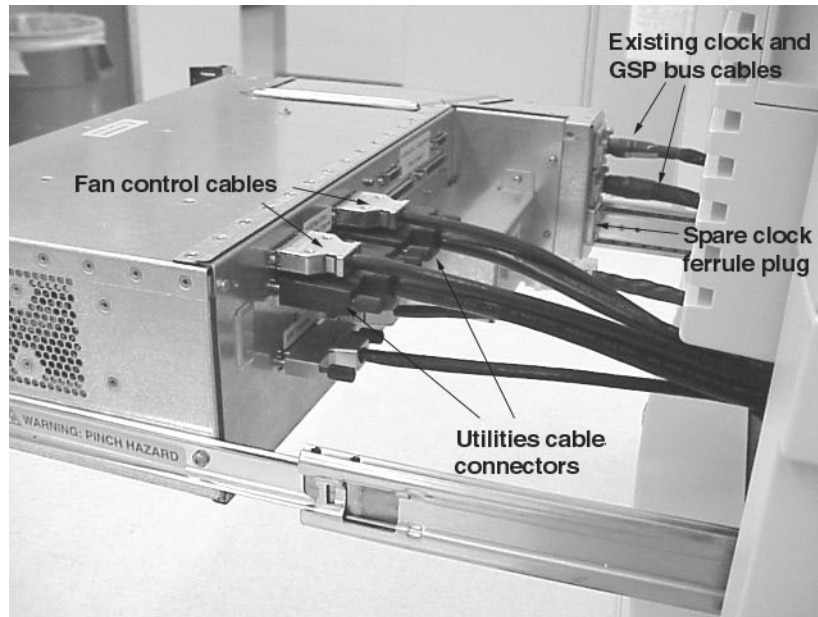

Figure 4-9 Typical Cables Connected to XUC



XPC Cable Routing

The XPC provides the power for the other units in the IOX (ICEs and XUC). There are up to four DC power cables running from the XPC. These cables are secured to the back rack brace with tie wraps. They are run up through the rack channels and secured with tie wraps to the channel brackets.

The XPC also has one power control cable coming from the XUC. It can be bundled and routed with the power cables.

Figure 4-10 XPC Cable Routing

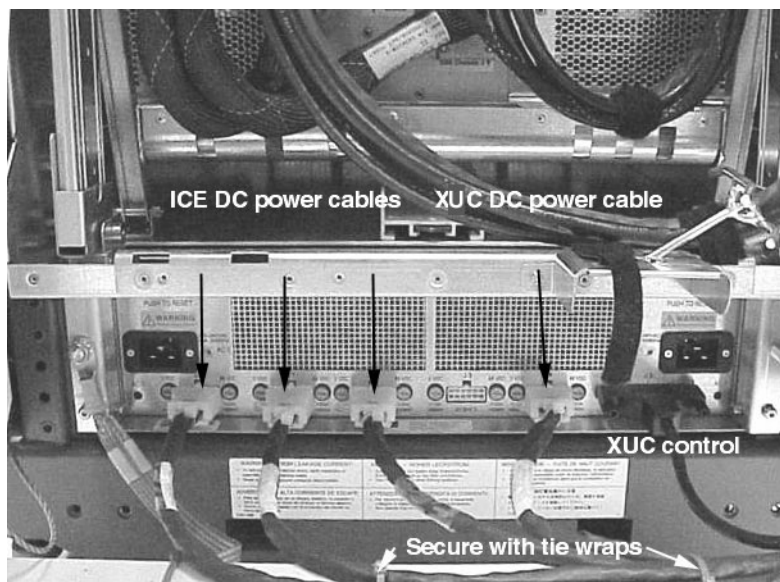

5 Adding an ICE to the IOX

Preliminary Installation

The following is a list of tools required for ICE assembly and service operations:

- Anti-static mat with provisions for connecting to chassis ground
- Wrist strap
- T-8, T-10, T-15, T-20, T-25 Torx bits
- Drive extension
- #1 and #2 Phillips bits
- Allen wrench set
- Nut drivers set
- 6-inch crescent wrench

The IOX cabinet is shipped with at least one ICE. Additional ICEs, however, may be installed later.

The ICE may be mounted in one of three locations in the rack.

To install an ICE into the IOX cabinet:

Step 1. Remove the ICE from its shipping carton and inspect it for damage.

Step 2. Determine where the ICE is to be located.

Installing Equipment Rails

Step 1. Open the rear door.

Step 2. Place clip nuts to the cabinet channels where the ICE is to be mounted at both the front and the rear of the cabinet.

Step 3. Bolt the rail to the column as shown in Figure 5-1 using two T20 torx screws.

The rails have hooks, one in the front and one in the rear that fit into the slots in the rack channel. There are two rails for each ICE. Each rail fastens to the cabinet channels with a screw in the front and one in the back.

NOTE Some rails may be tight and require extra force to install.

Figure 5-1 Attaching the Rails

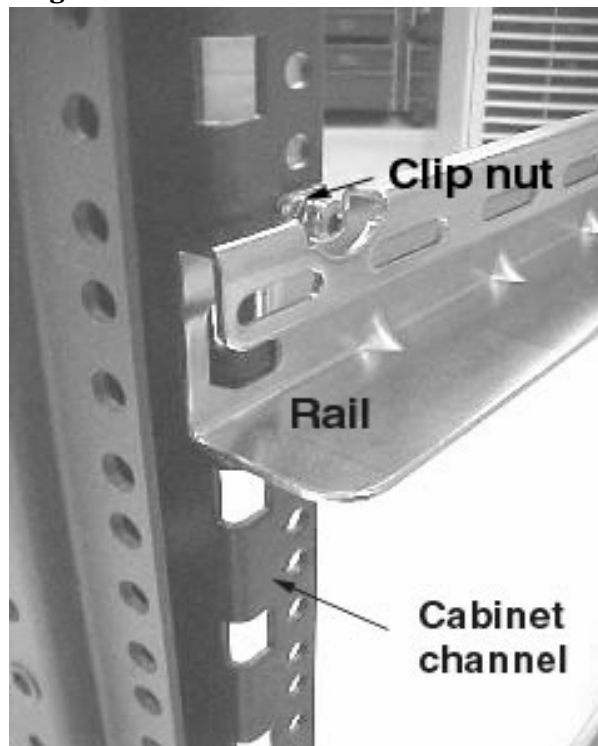

Step 4. Attach the two rear mounting brackets on each side of the IOX using two each (per bracket) T20 Torx screws and secure to the rear channel using two T20 torx screws.

Figure 5-2 ICE Rear Mounting Bracket



Mounting the ICE into the Rack

WARNING Use two people or a lifting device as the unit is bulky as well as heavy.

CAUTION Use care not to damage the rear captive, mounting screws while installing the ICE.

The ICE is secured to the rear mounting bracket with two captive screws. The screws fasten to the mounting bracket from the inside of the ICE. They, therefore, tend to stick out from the ICE. The ICE is shipped with tape covering these two screws to keep them held in place. It is important that these screws not get caught on or snag the cabinet channels when the ICE is pushed into the rack.

Step 1. Using two people or a lifting device, carefully lift the ICE and slide into the cabinet.

Figure 5-3 Mounting the ICE

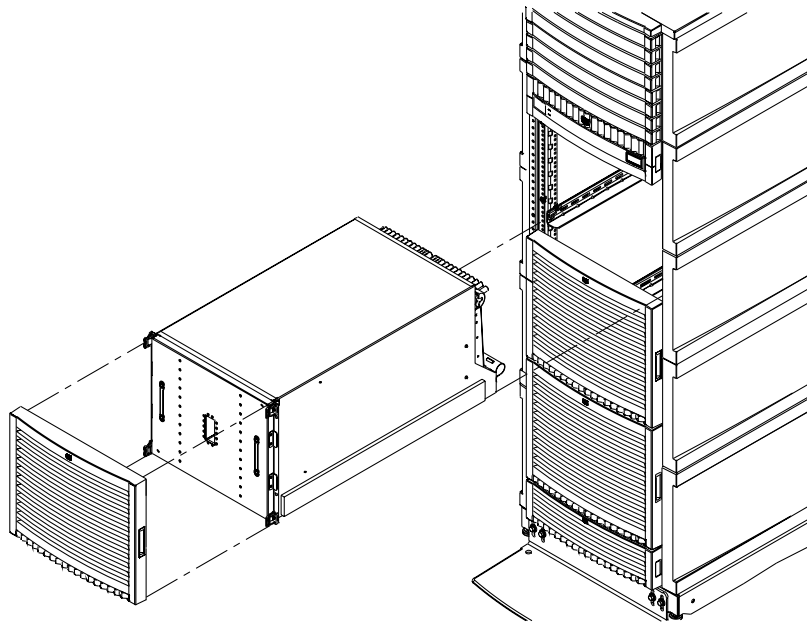

60IOX013
11/15/00

Step 2. Slide the ICE back until the lip meets the front channels.

Step 3. Secure with four T-20 Torx screws in the front of the rack.

Figure 5-4 ICE Front Mounting Screws

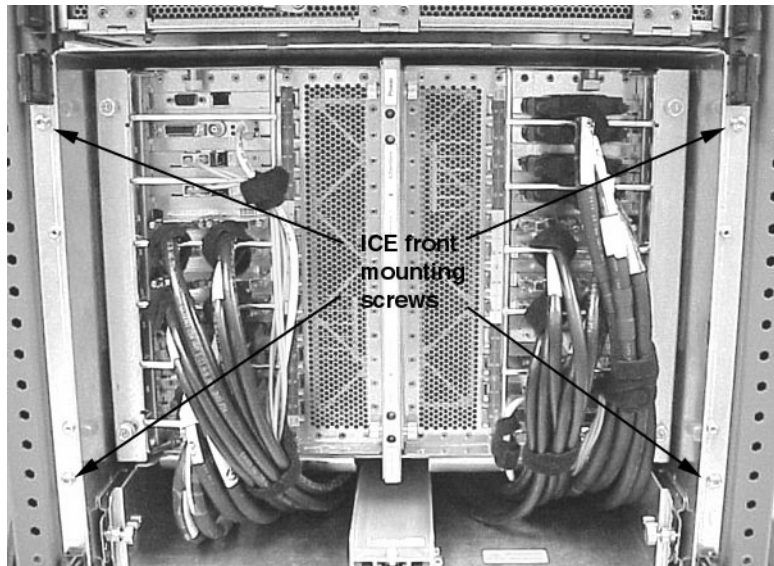

Step 4. Attach the two rear mounting brackets on each side of the IOX using two each (per bracket) T20 Torx screws and secure to the rear channel using two T20 torx screws.

Figure 5-5 ICE Rear Mounting Bracket



Step 5. Secure the ICE to the mounting brackets using the two captive screws.

Installing the ICE Components

You will have to install the I/O chassis into the new ICE. But before that, the I/O chassis have to be populated with the I/O cards for your particular configuration.

Step 1. Extend the ICE on its tray by unlocking the retaining pins and sliding it out of the rack until the rack slides lock.

Figure 5-6 ICE Tray Retaining Pins

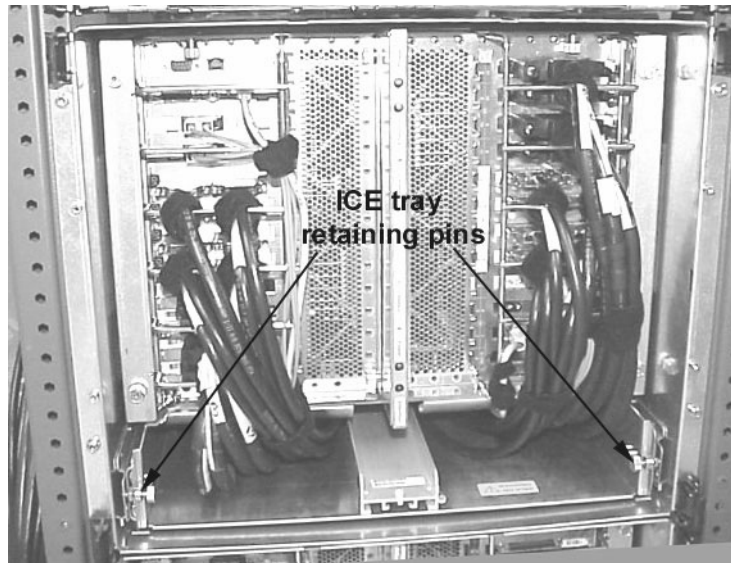

Step 2. Insert all PCI controller cards into the I/O chassis (one or two chassis).

Figure 5-7 Installing the Controller Cards

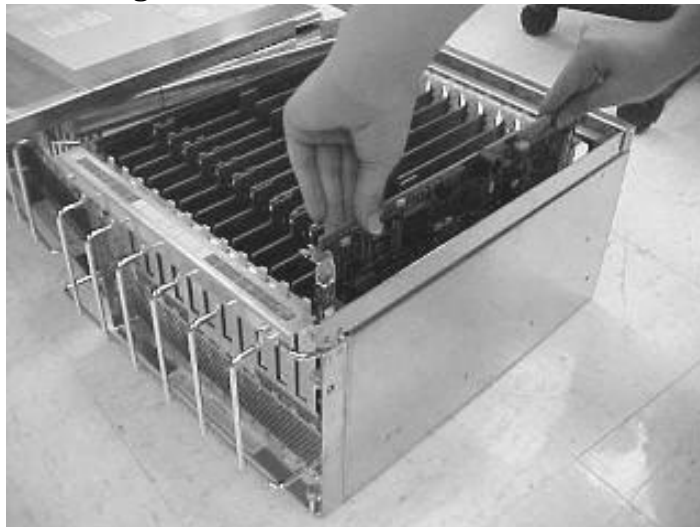

Step 3. Carefully lift the I/O chassis and slide it into the ICE. Insure that it fully seats into the connectors.

CAUTION Do not slam the I/O chassis into the ICE.

Adding an ICE to the IOX
Mounting the ICE into the Rack

Step 4. Install the lid onto the I/O chassis

Step 5. Secure the I/O chassis by tightening the three captive screws

Figure 5-8 **Securing the I/O chassis**

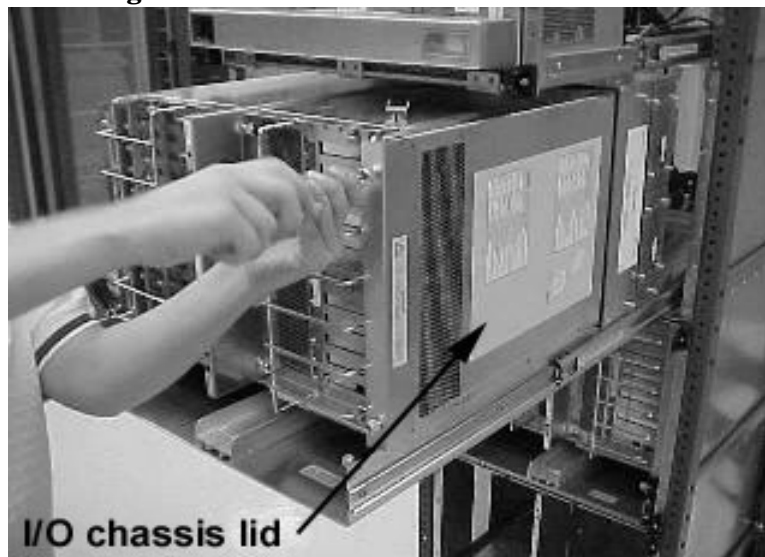

Connecting the Cables

All internal ICE cables are connected prior to shipping the ICE. The ICE has several external cable connections on the backplane. You will have to connect the following cables:

- REO
- ICE-to-XUC clock
- Fan Control
- DC Power
- ICE Utilities
- I/O cables from the I/O chassis

Removing the Fan Shield

Before the ICE cables can be installed, you must remove the fan shields covering the XMIOBs.

Step 1. Remove the left and right I/O fans by loosening the four T10 Torx screws on each fan and pulling them out of the chassis.

Figure 5-9 ICE Fan Removal

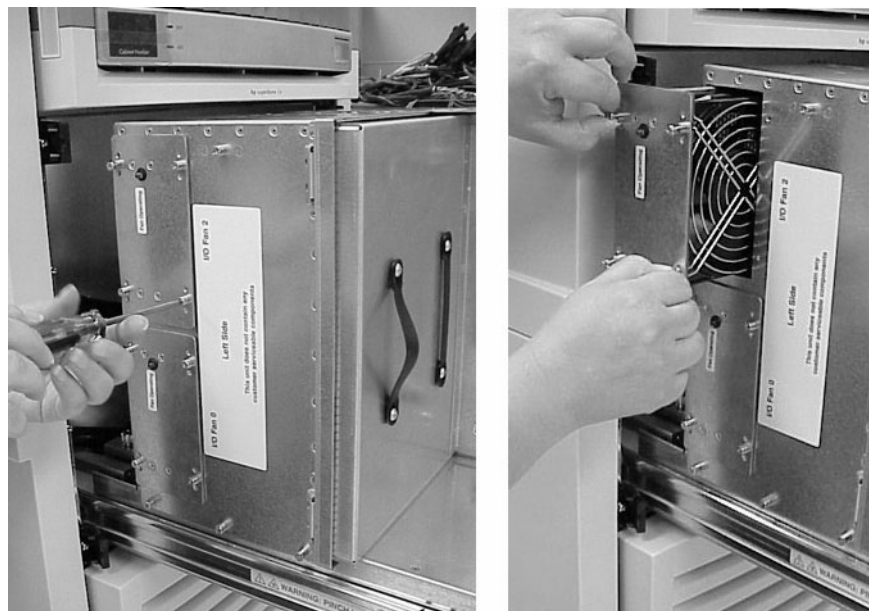

Step 2. Remove the fan shields to access the clock and REO cable connectors by loosening the four T10 Torx screws on each shield (two per ICE).

Figure 5-10 Removing Fan Shield



Figure 5-11 shows the location of connectors and mounting holes for cables to be attached in this procedure. In the figure no tables are shown. The ICE, however, is shipped with tables identifying each connector.

Figure 5-11 ICE Connector Locations

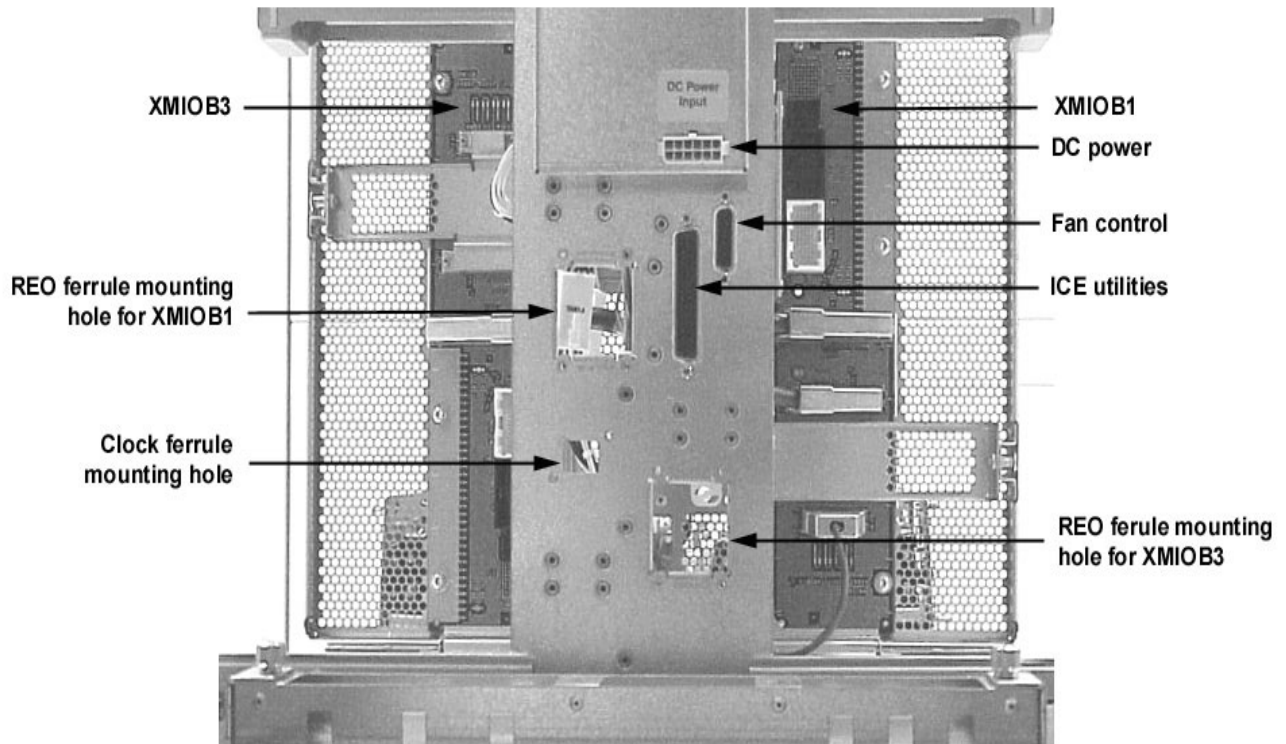

NOTE When viewed from the rear (as in Figure 5-11), the REO for XMIOB1 is on the left and the REO for XMIOB3 is on the right. The REO cables *cross over each other* inside the ICE.

Connecting the REO Cables to ICE Backplane

IMPORTANT The ICE may ship with the REO cables already attached. If this is the case, skip this section.

This section describes how to connect the REO to the Superdome server. The section “Connecting the IOX to the Superdome” on page 58 has additional information. It is recommended that you read that section first.

The REO cables are shipped with their ferrules attached at one end of the cable for mounting to the ICE. You will pass the REO cables through the ferrule mounting holes and push the connectors onto the XMIOB connectors.

Step 1. Locate the ends of the REO cables that has the ferrule attached.

NOTE Each REO cable has two connectors (input and output) that attach to each XMIOB. There are two XMIOBs per ICE, one for each I/O chassis, but you may only have one I/O chassis, and therefore, will only connect one pair of connectors to one XMIOB.

Step 2. Pass the cables over the cable management arm, under the cable strain relief arm, and run the connectors through the appropriate REO ferrule mounting hole(s). Mark the opposite end of this REO cable with the correct XMIOB number. This will help in the identification for later attachment to the Superdome.

Figure 5-12 **Securing REO Cables**

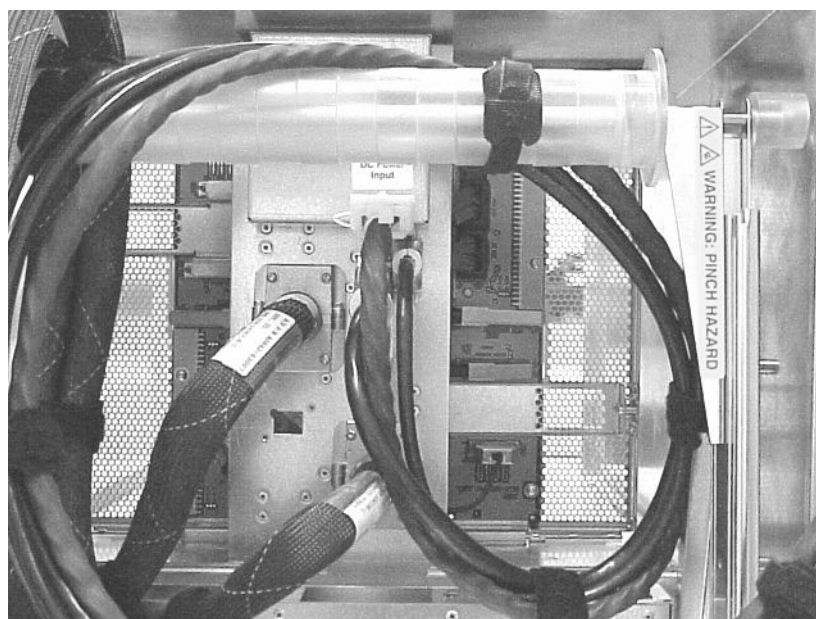

Step 3. Remove the strain relief bracket.

Step 4. Push the ferrule(s) up to the mounting hole(s) and secure with four screws supplied.

Figure 5-13 REO Cable Ferrule Mounted in ICE



Step 5. Push the REO cable connectors into their respective connectors on the XMIOB.

IMPORTANT Install the REO cable with the white marker band to the white cable connector on the XMIOB.
Install the REO cable with the black cable marker band to the black connector on the XMIOB.

NOTE When viewed from the rear (as in Figure 5-14), the REO for XMIOB1 is on the left and the REO for XMIOB3 is on the right. The REO cables cross over each other inside the ICE.

Figure 5-14 REO and Clock Connectors on the XMIOB

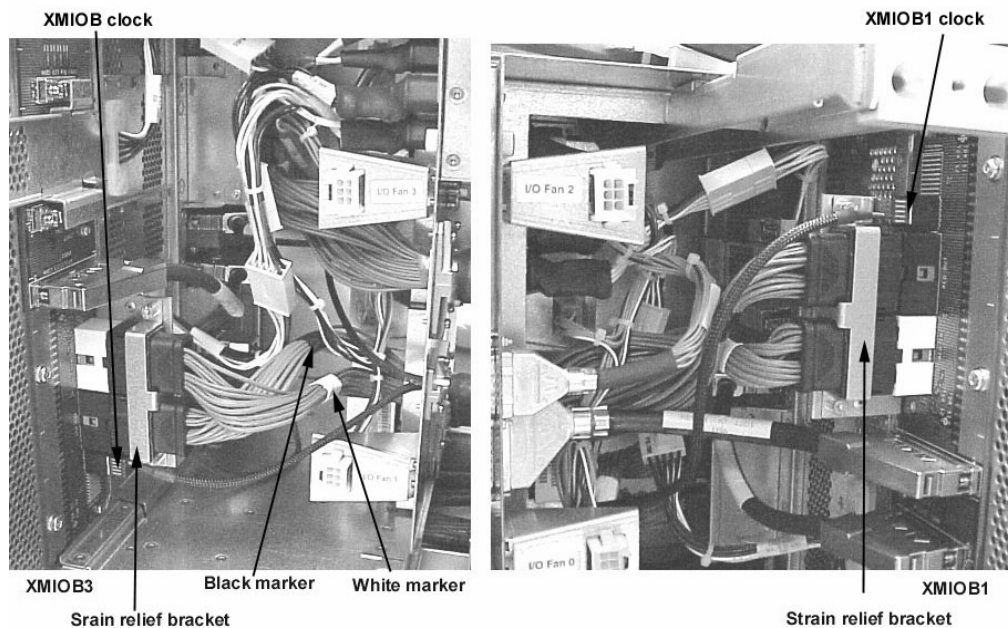

Step 6. Attach the strain relief bracket.

Connecting the REO Cables to the Superdome Server

Step 1. Remove the rear door on the Superdome server by sliding it up off the hinge pins.

Follow the procedures found in the section “Removing Old Side Skins” on page 31, starting with Step 3.

Step 2. Cut the green tie wraps and remove the green VELCRO ties holding the REO cables during shipment.

Step 3. Remove the appropriate R-PEC from the cable exit panel by loosening the two T15 Torx screws.

The REO cable pairs from the ICE mounted lowest should mount and run through the bottom R-PEC in the cable exit panel. Likewise, the REO cables from the next higher ICE pass through the next higher R-PEC, and so on.

In Figure 5-15, the IOX is not in place for illustrative purposes.

Figure 5-15 **Removing R-PEC**

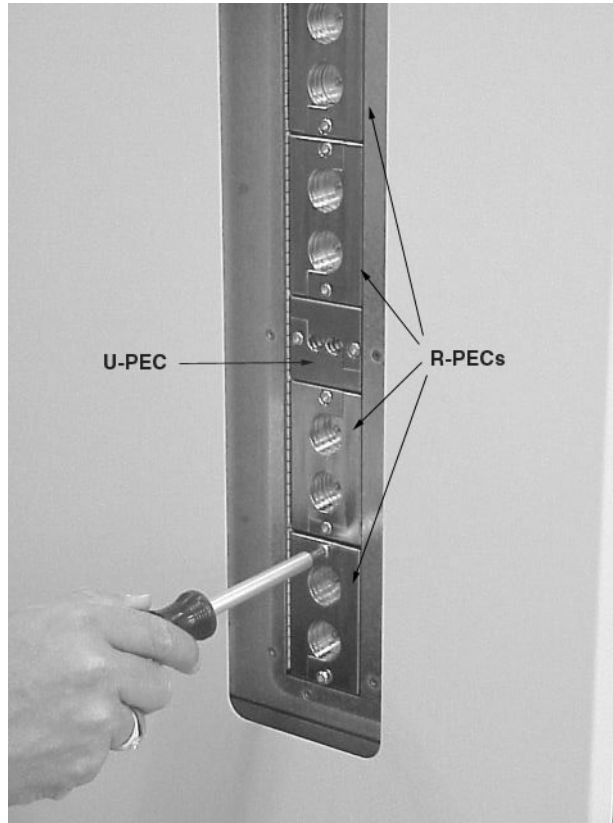

Step 4. Determine the destination to the Superdome server of the REO cable and pass the REO cable pair through the cable exit panel where the R-PEC was removed.

Step 5. Determine which shield protector to remove (green or blue) and pull the perforated section. Discard the plastic. The shield is exposed after the protector is removed.

Use the blue section when the destination Superdome cabinet is next to the IOX. Use the green section when there is another cabinet between the IOX and the destination Superdome cabinet. See the discussion in the section “Connecting the REO and GSP Bus Cables” on page 59.

Step 6. Separate the halves of an R-PEC.

The R-PEC attaches to the exposed shield in the REO cable. There are two halves that fasten together with three T15 Torx screws. REO cables are always attached in pairs. Each R-PEC, therefore, has two holes. Unused R-PECs must have blanks in the holes.

IMPORTANT The R-PEC blanks must occupy all unused holes.

Step 7. Attach the REO cable clamp R-PEC to the cable at the exposed shield using two T15 Torx screws. See Figure 5-16.

Figure 5-16 **Installing the R-PEC**

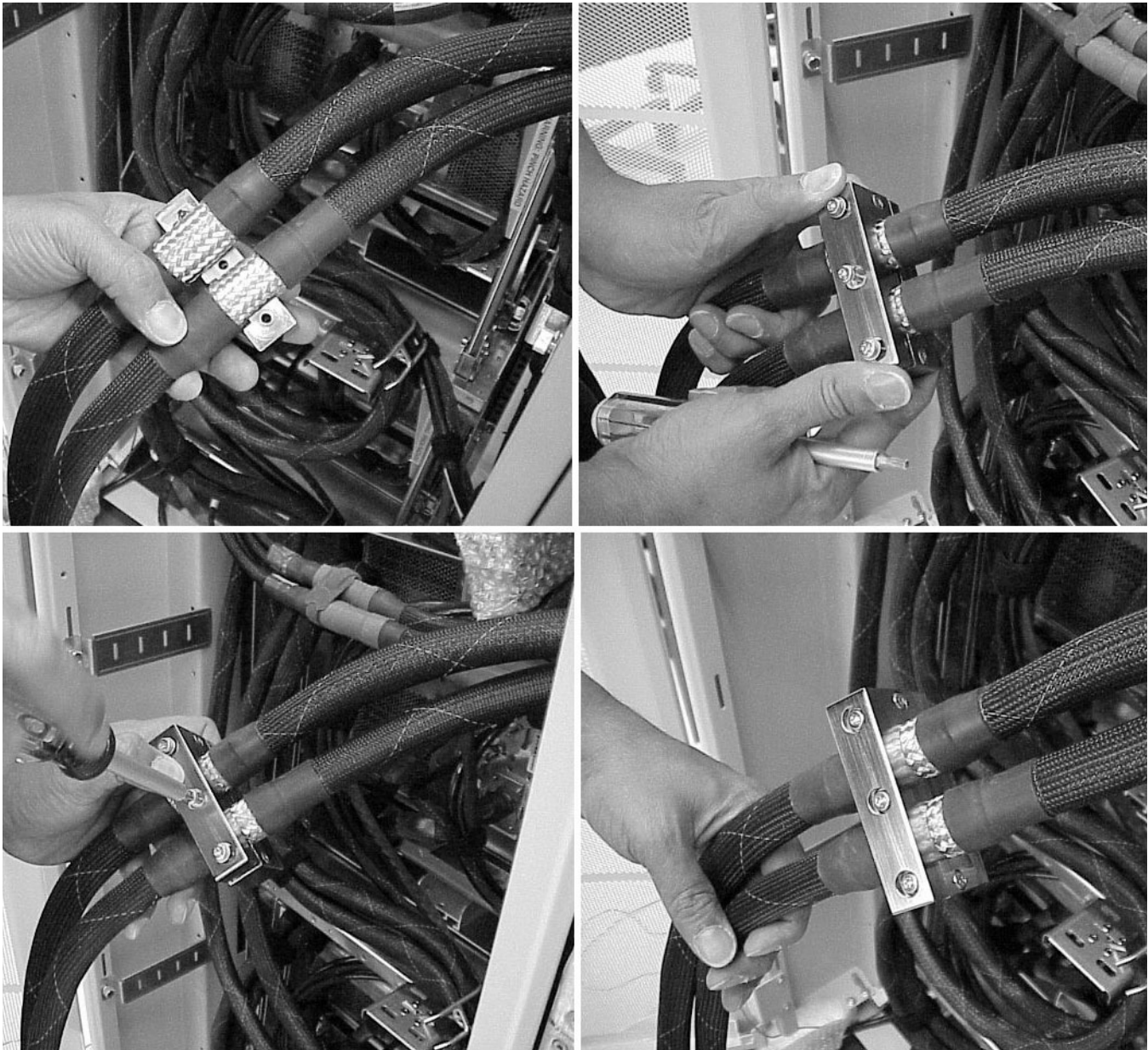

Step 8. Install the R-PEC in the appropriate location on the cable exit panel using two T20 Torx screws.

Step 9. Connect the REO cable to the appropriate Cell board connector in the Superdome server.

Connecting the XUC-to-ICE Clock Cable

Connecting the Clock Cable to the XUC

If there are only two ICEs in the IOX after the upgrade (that is, there was only one before the upgrade), this section may be skipped, because one clock cable supplies clocks to the first two ICEs (0 and 1).

Step 1. Remove the front bezel from the XUC by grasping the indentions on both sides of the bezel and

pulling toward you.

Step 2. Remove the two XUC module retaining screws: one on each side of the XUC.

Figure 5-17 Removing XUC Retaining Screws



Step 3. Pull out the XUC from the IOX by pushing down on the front display and pulling it out until the slides lock.

Figure 5-18 XUC Extended

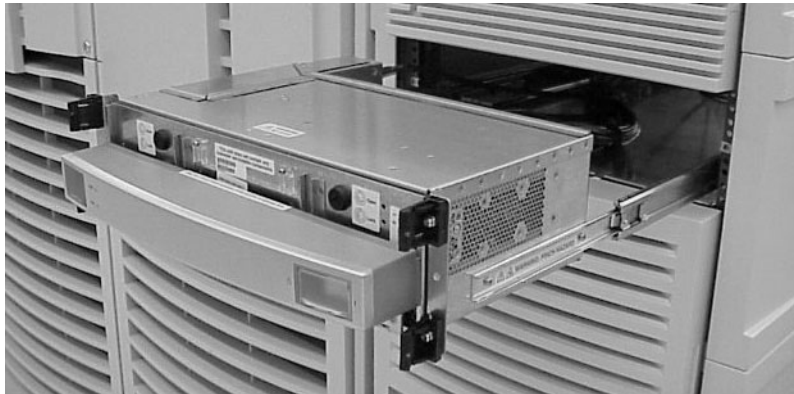

Step 4. Remove the XUC side panel by loosening the six captive T10 Torx screws. This panel allows access to the ICE clock and GSP bus connections.

Figure 5-19 Cable Access Panel

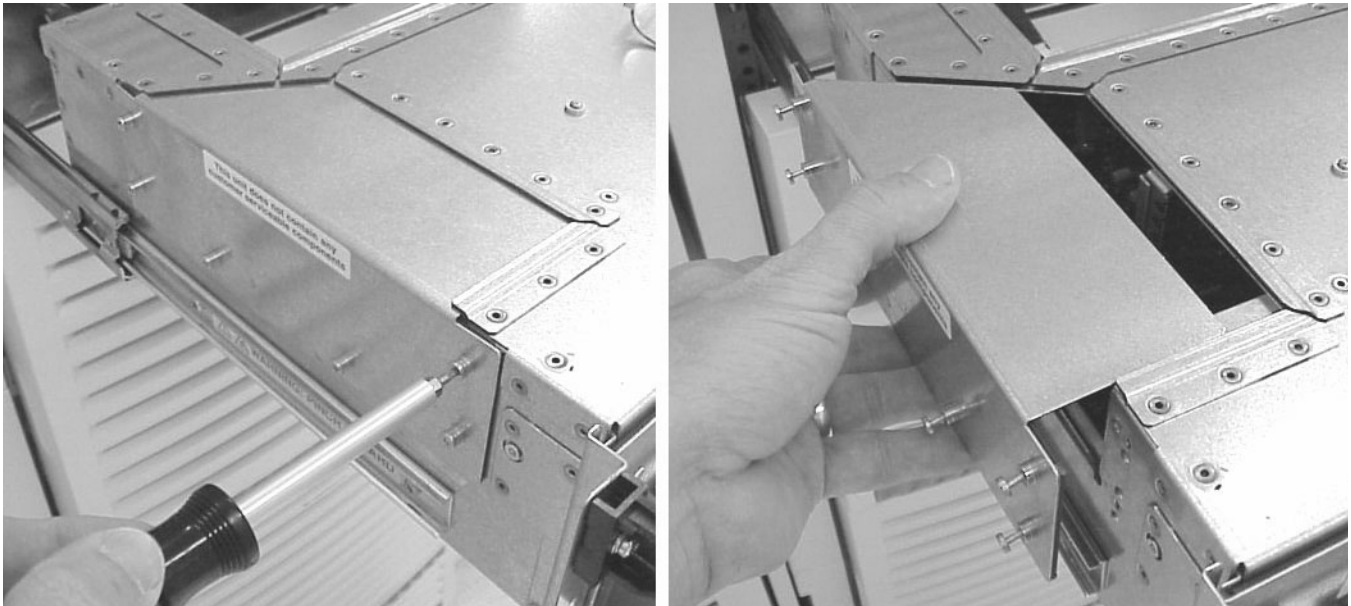

Step 5. While looking from the back of the XUC, locate the three small ferrule mounting holes on the right side of the XUC.

The first two holes will have cables already mounted: the ICE 0/1 clock cable and the GSP bus cable that goes to the Superdome server. The remaining hole has a plug covering it.

Figure 5-20 Back of XUC

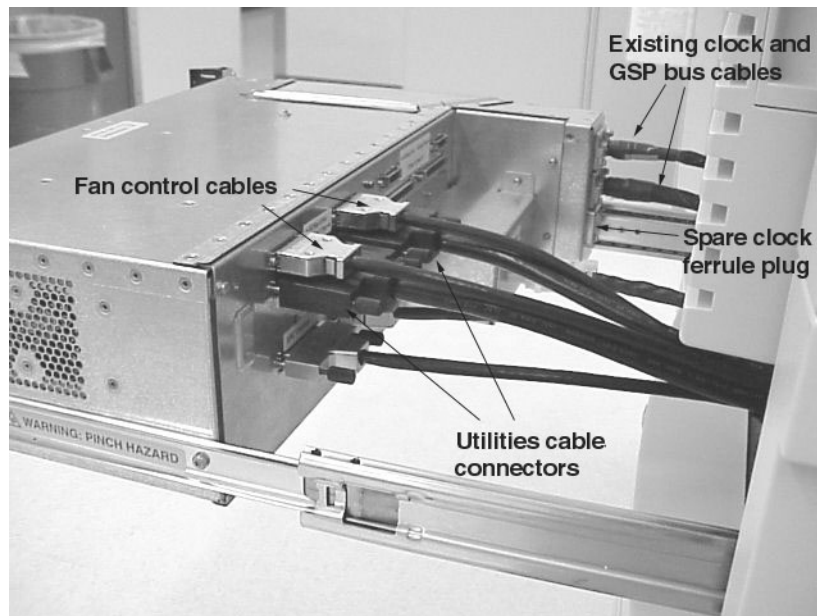

Step 6. Remove the plug and insert the XUC end of the clock cable into the hole.

Step 7. Locate the ICE clock cable connectors and push the clock cable into the connector closest to the already connected cable.

Figure 5-21 Clock and GSP Bus Cables

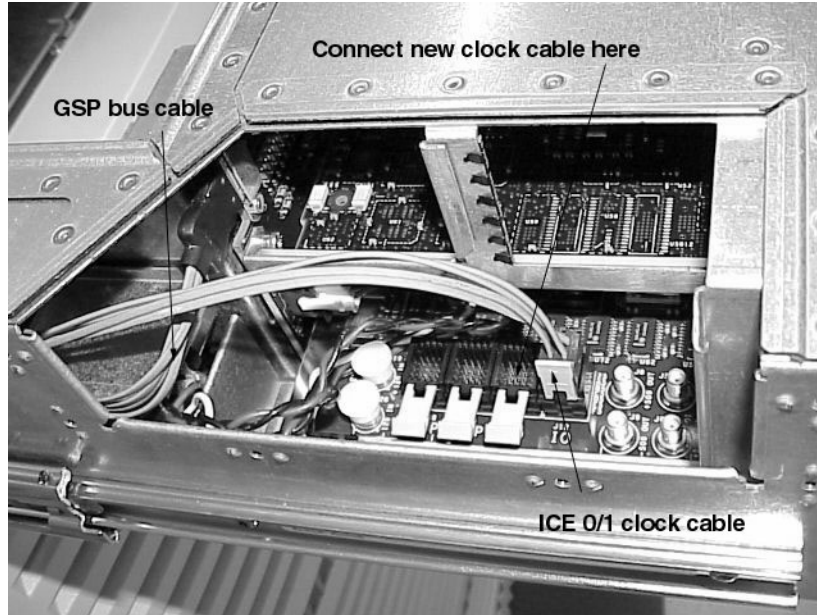

Step 8. Secure the clock cable ferrule to the back of the XUC using two T10 Torx screws.

Step 9. Reattach the cable access panel by tightening the six T10 torx screws.

Connecting the Clock Cable to the ICE

Step 1. Pass the cable from the back of the XUC, down the nearest rack channel, over the cable management arm of the newly installed ICE, and under the cable strain relief arm. Be sure to add enough service loop when routing the clock cable to allow the ICE to extend fully.

Figure 5-22 Cable Management Mechanism

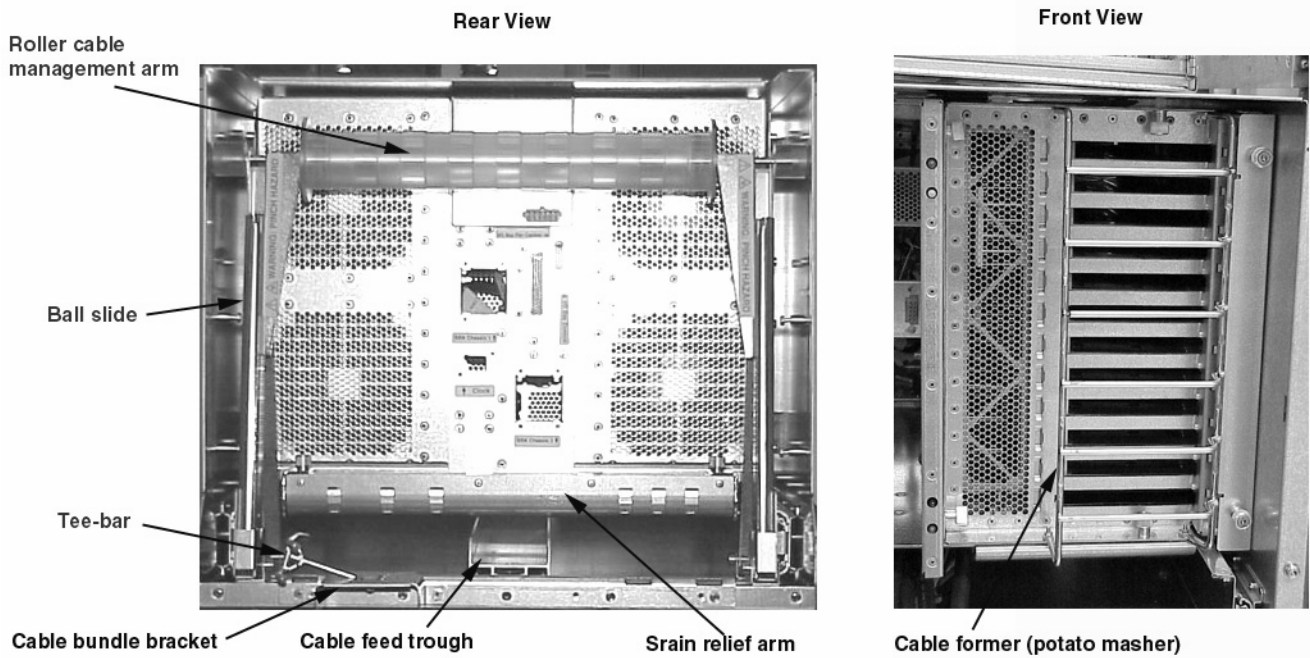

- Step 2.** Locate the clock ferrule mounting hole at the rear of the ICE and pass the two clock connectors cable through. See Figure 5-11 on page 96.
- Step 3.** Secure the clock ferrule with two T20 Torx screws.
- Step 4.** Locate the clock connectors on the XMIOBs.

NOTE The XMIOBs are identical, but they are inverted from one another. Therefore, the clock connector on the left (looking from the back side of the ICE) is near the bottom of the XMIOB and the clock connector on the right XMIOB is near the top of the XMIOB.

NOTE In configurations with one or three ICEs, there will be an unused, and exposed, clock connector in one clock cable. This unused section of cable should be stored in the zip-lock EMI shielded bag provided.

- Step 5.** If necessary, remove the REO strain relief.
- Step 6.** Push both clock cable connectors into the connectors on each XMIOB.

Figure 5-23 REO and Clock Connectors on the XMIOB



- Step 7.** If necessary, reinstall the REO strain relief.
- Step 8.** Secure the clock cable to the strain relief arm, the roller management arm, and the rear of the ICE chassis at the Tee-bar or cable bundle bracket.

Figure 5-24 Cable Management Mechanism

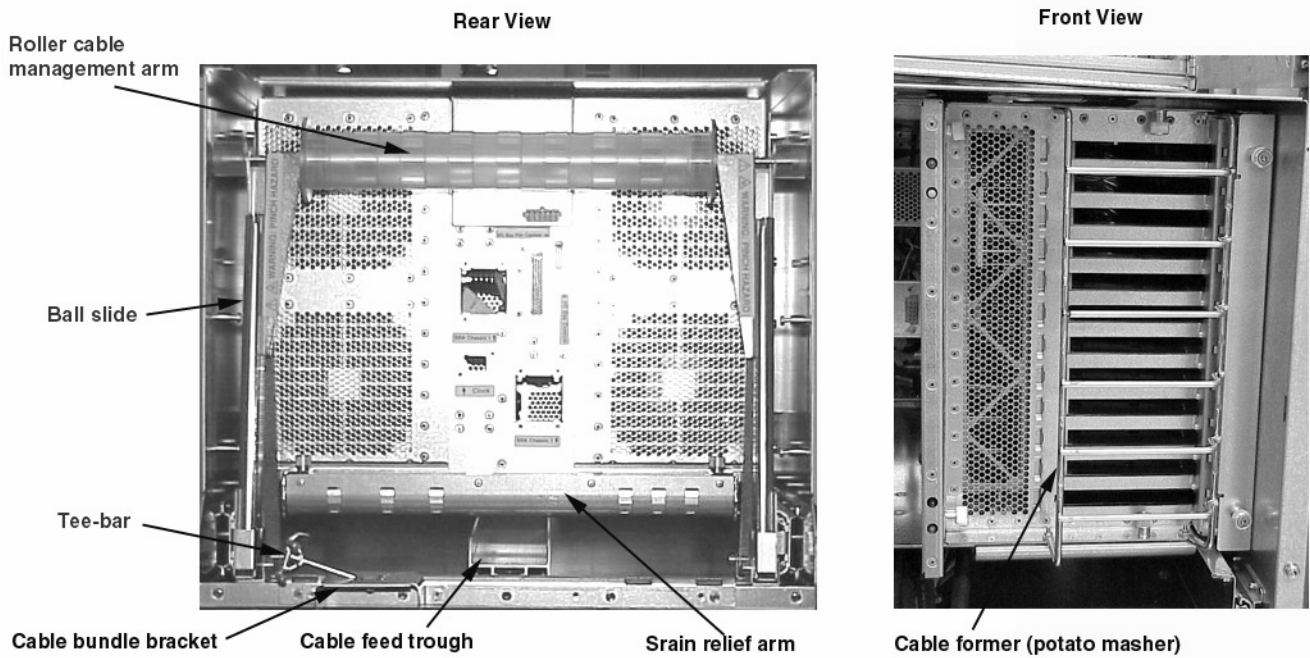

Connecting the Utilities Cable

For every ICE, there is one utilities cable that runs from the XUC to the ICE.

- Step 1.** Locate the XUC end of the utilities cable and connect to the appropriate connector on the rear of the XUC. See Figure 5-20 on page 103. Be sure to add enough service loop when routing the cable to allow the ICE to extend fully.
- Step 2.** Pass the cable from the back of the XUC, down the nearest rack channel, over the cable management arm, under the cable strain relief arm of the newly installed ICE.

Figure 5-25 Routing the Utilities Cable

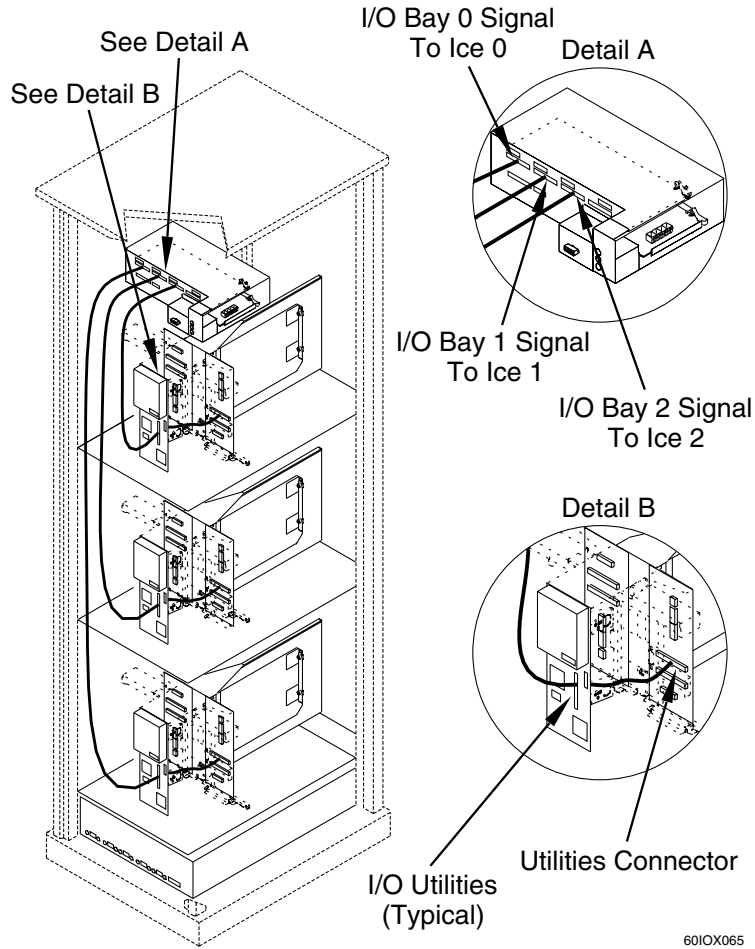

Step 3. Locate the utilities connector on the back of the ICE. See Figure 5-11 on page 96.

Step 4. Secure the connector by tightening the two captive cable connector screws. Secure the cable to the strain relief arm, the roller management arm, and the rear of the ICE chassis at the Tee-bar or cable bundle bracket.

Figure 5-26 Cable Management Mechanism

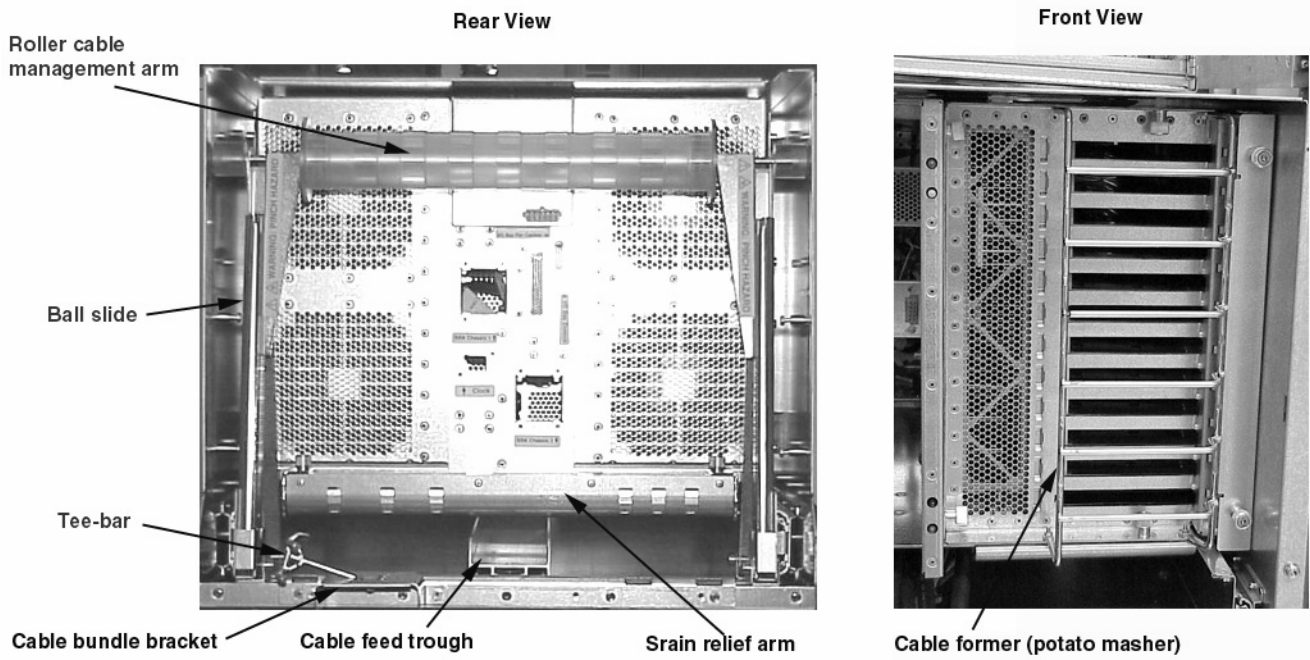

Connecting the Fan Control Cable

For every ICE, there is one fan control cable that runs from the XUC to the ICE.

- Step 1.** Locate the XUC end of the fan control cable and connect to the appropriate connector on the rear of the XUC. See Figure 5-20 on page 103.
- Step 2.** Pass the cable from the back of the XUC, down the nearest rack channel, over the cable management arm, under the strain relief arm of the newly installed ICE. Be sure to add enough service loop when routing the cable to allow the ICE to extend fully.

Figure 5-27 Routing Fan Control Cable

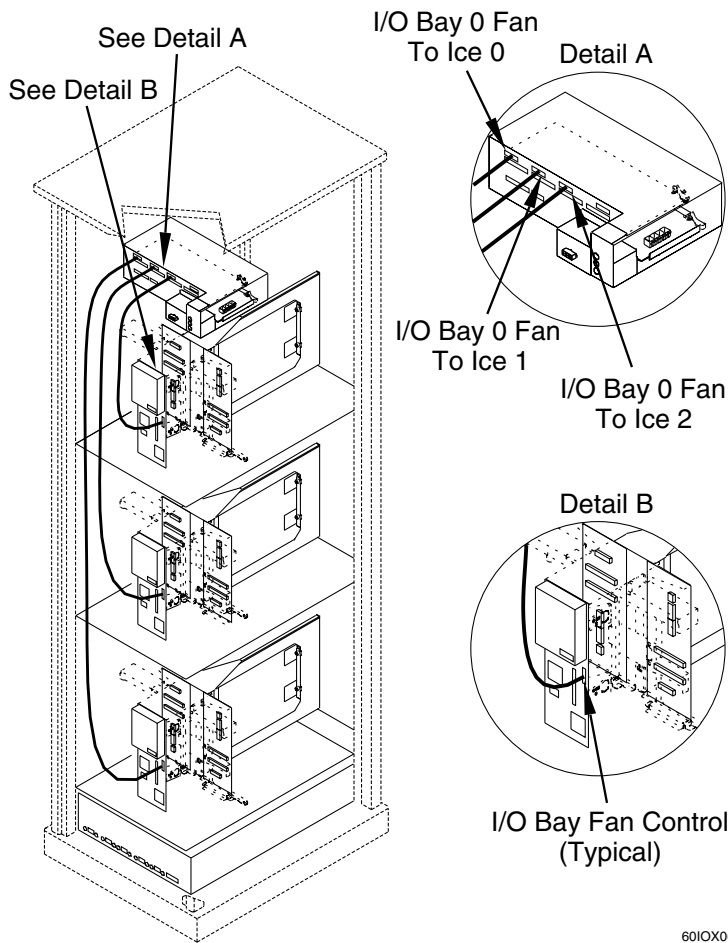

- Step 3.** Locate the fan control connector on the back of the ICE. See Figure 5-11 on page 96.
- Step 4.** Secure the connector by tightening the two captive cable connector screws. Secure the cable to the strain relief arm, the roller management arm, and the rear of the ICE chassis at the Tee-bar or cable bundle bracket.

Connecting the ICE DC Power Cable

For every ICE, there is one power cable that runs from the XPC to the ICE.

- Step 1.** Locate the XPC end of the power cable and connect to the appropriate connector on the rear of the ICE. See Figure 5-20 on page 103.
- Step 2.** Pass the cable from the back of the XPC, down the nearest rack channel, over the cable management arm, under the strain relief arm of the newly installed ICE. Be sure to add enough service loop when routing the cable to allow the ICE to extend fully.

Figure 5-28 **Routing ICE DC Power Cable**

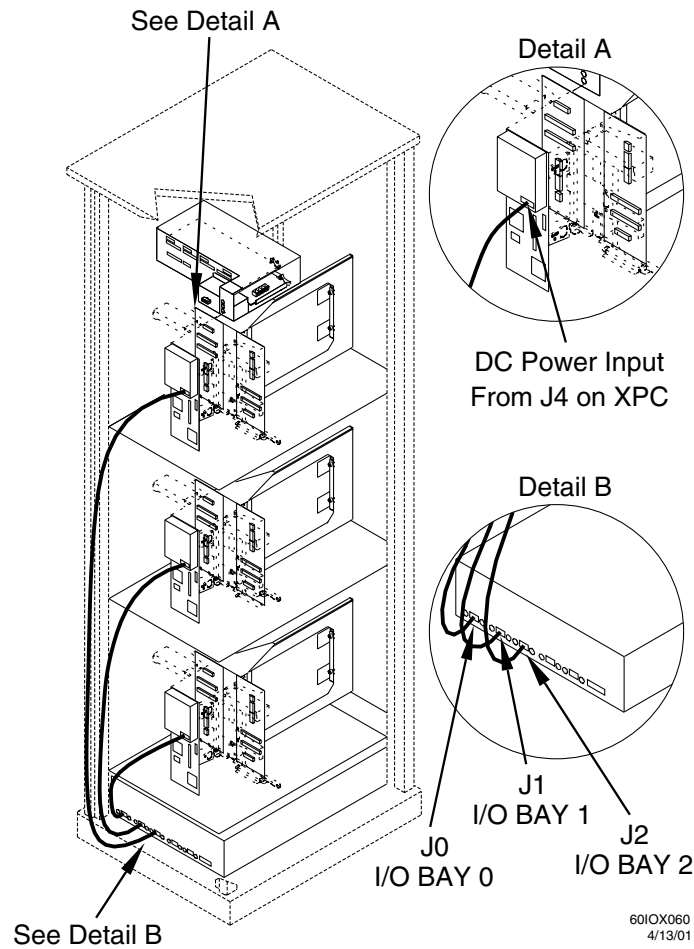

- Step 3.** Locate the power connector on the back of the ICE. See Figure 5-11 on page 96.
- Step 4.** Secure the connector. Secure the cable to the strain relief arm, the roller management arm, and the rear of the ICE chassis at the Tee-bar or cable bundle bracket.

Completing the Upgrade

After all cables have been installed the ICE is ready to be pushed into the cabinet.

Reinstalling the Fan Shield

Step 1. Install the fan shields by tightening the four T10 Torx screws on each shield (two per ICE).

Figure 5-29 Installing ICE Fan Shields

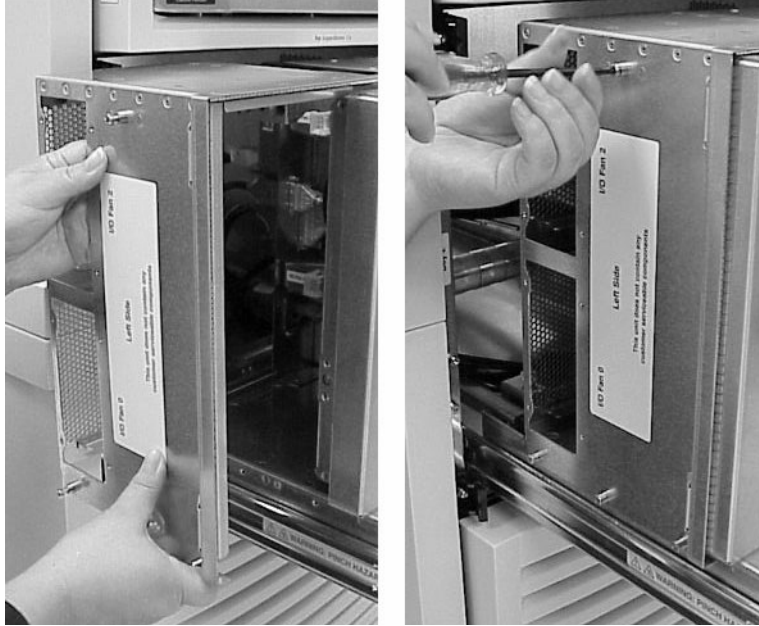

Step 2. Install the left and right I/O fans by pushing them onto the ICE and tightening the four T10 Torx screws. Insure that the EMI shielding is not damaged.

Figure 5-30 Installing Fans



Connecting I/O Cables

Each I/O cable bundle should be routed off of the ICEs in alternating fashion. For example, the cable bundle in the bottom ICE may exit to the right. The bundle in the middle ICE should then exit to the left. And the bundle in the top ICE should then exit to the right. This method helps distribute the I/O bundles more evenly. The cable bundle brackets can be mounted on either side of the ICE. See Figure 5-32.

Under and between the I/O chassis is a cable routing trough shown in Figure 5-31. The trough provides a clear path from the front of the ICE to the rear, allowing the cable to be routed without getting caught or snagged on existing cables. The cable puller is stored under the cable trough.

Figure 5-31 Cable Routing Trough

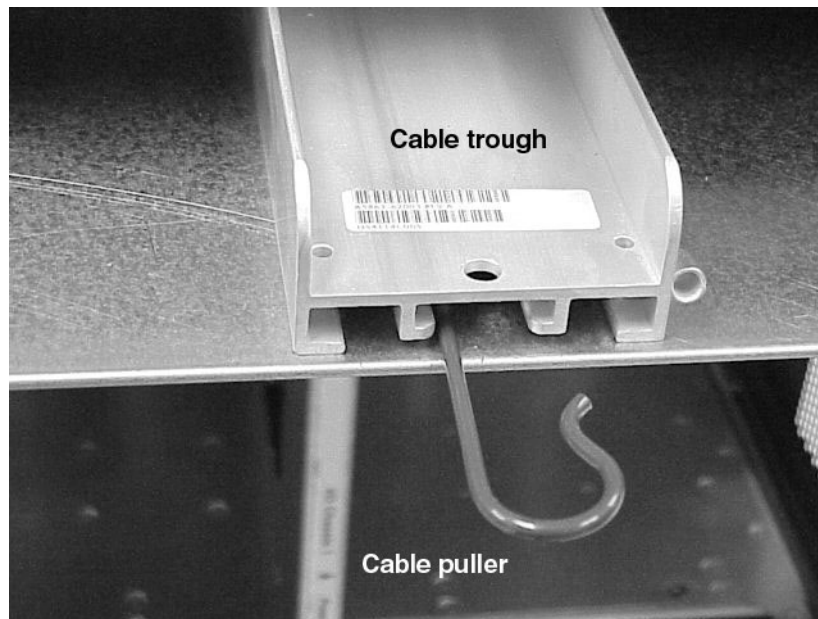
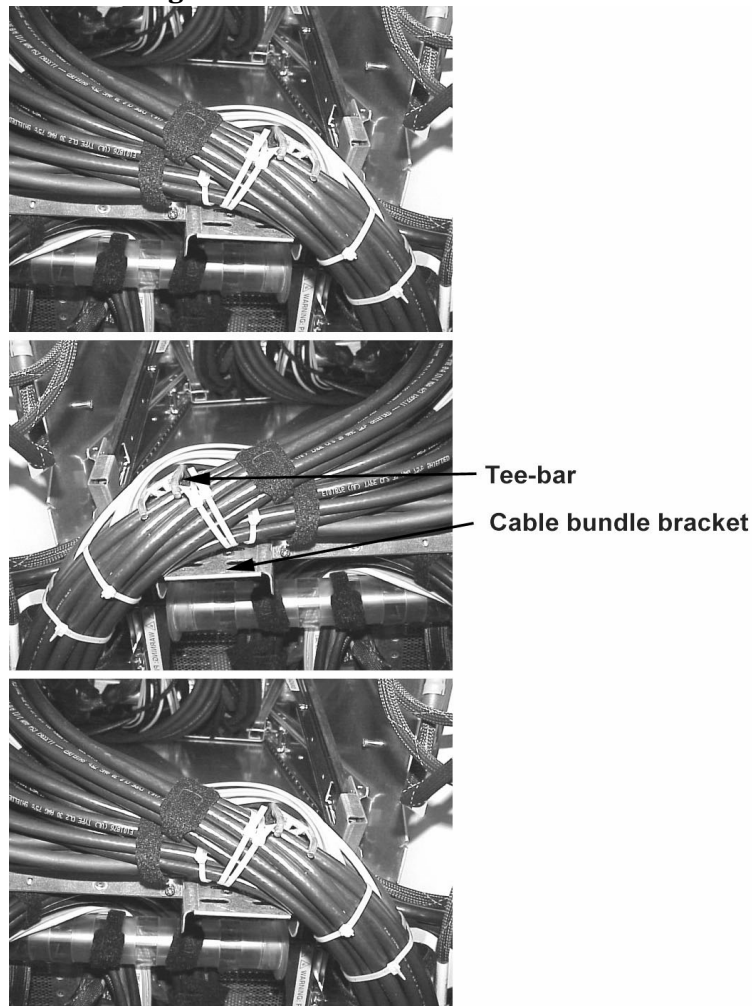
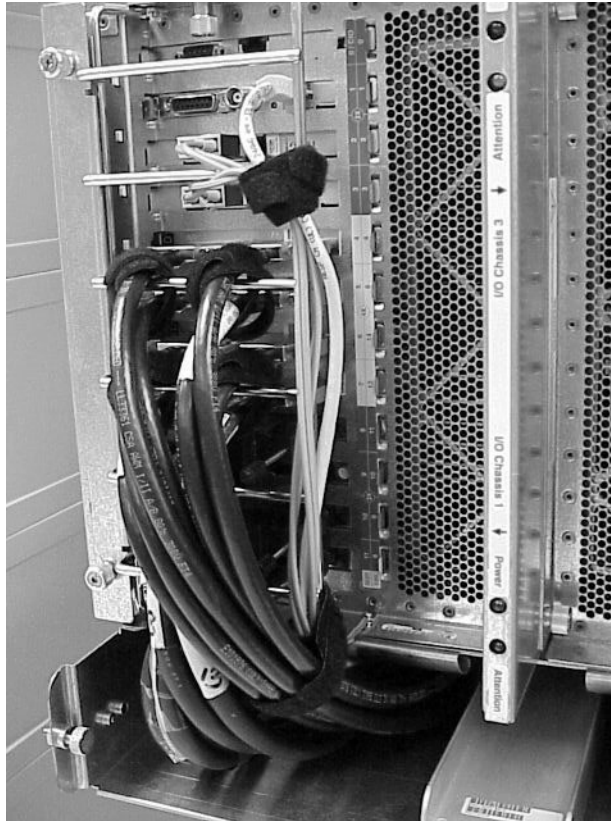

Figure 5-32 Alternating the I/O Cable Bundles



Step 1. For every PCI controller in the I/O chassis, route each cable from the back of the IOX, into the cable routing trough under the I/O chassis, through the cable groomer (also know as “potato masher”) (See Figure 5-33), and connect it to the appropriate PCI controller.

Figure 5-33 I/O Cables Connected to PCI Controllers



- Step 2.** Feed the cable from the back over the roller management arm to the base of the tray.
- Step 3.** Catch the cable with the cable puller tool and pull the cable through the cable trough to the front of the tray.
- Step 4.** From the front of the tray, pull the cable out of the trough into the tray area.
- Step 5.** Feed the cable through the potato masher and plug it into the appropriate PCI controller connector.
- Step 6.** Secure the cable to the potato masher with cable ties.
- Step 7.** Secure the cables to the roller management arm.
- Step 8.** When all I/O cables have been routed to the front of the PCI chassis and secured to the potato masher, neatly bundle them using tie wraps. Secure the to the cable bundle bracket using the tee-bar and cable ties. See Figure 5-34. Use VELCRO ties to bundle cables.

Figure 5-34 **Securing the Bundles to Teebars**

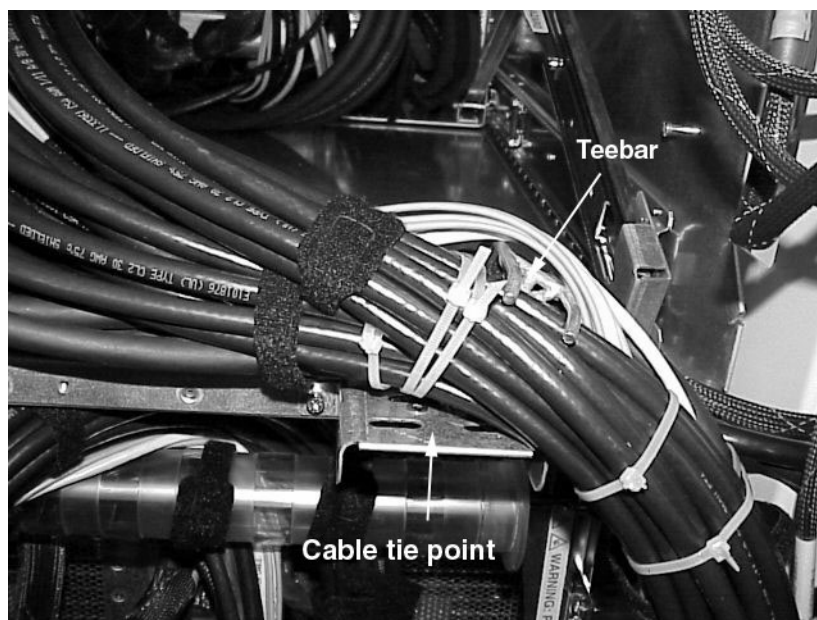

Step 9. Use channel brackets, tie slots, and tie-wrap anchors to secure cables that run along the rack channels.

Figure 5-35 **IOX Channel Bracket**

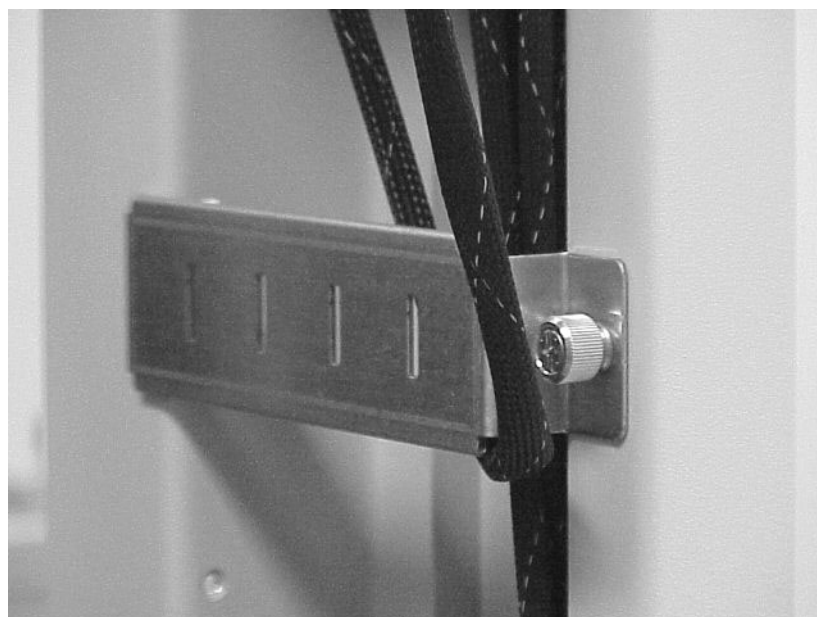

Securing the ICE

- Step 1.** Disengage the rail slide lock pins and slide the ICE into the cabinet and engage the tray locks.
- Step 2.** Install the EMI panel by tightening the retaining screw in the center of the panel. You have to hook the top of the panel to the holes on the ICE to secure the EMI panel.

Figure 5-36 EMI Screws

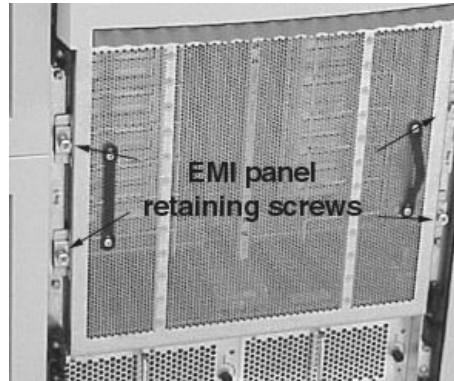

- Step 3.** Install front bezel.
- Step 4.** Close the rear door.

6 Remove and Replace Procedures

Removing the ICE

Required Tools

The following is a list of tools required for ICE assembly and service operations:

- T-10 and T-20 Torx bits
- TBD drive extension
- Torx driver

Removing Panels and Extending the ICE

Step 1. Locate the ICE to be removed and remove the side panels to access the mounting screws.

Figure 6-1 Remove Side Panels



Figure 6-2 Exposing the Channels and Rails

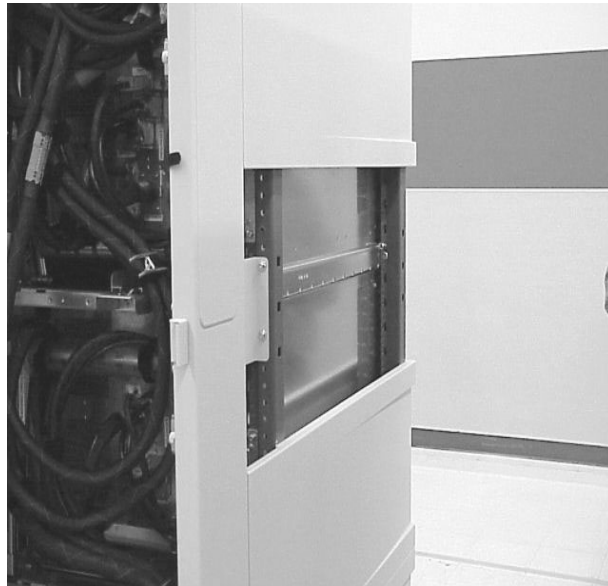

Step 2. Disable power to the ICE by removing the DC power connector on the rear of the ICE.

Step 3. Remove the front bezel from the ICE.

Figure 6-3 Removing the Front Bezel



Step 4. Remove the EMI panel from the ICE by loosening the four captive retaining screws and pulling the panel off.

This allows access to the ICE tray retaining pins.

Figure 6-4 **Removing the EMI Cover**



Figure 6-5 **ICE Retaining Pins**

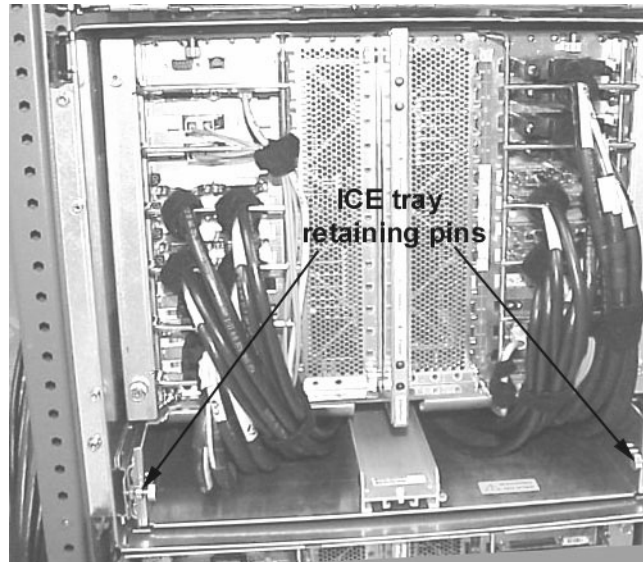

Step 5. Disengage the lock pins and slide out the ICE on its tray. Pull them out and give one-quarter turn.

Figure 6-6 **Extending the ICE**



Removing the Cables

The following cables must be removed from the ICE chassis.

- REO
- Clock
- Fan control
- Utilities
- DC power
- I/O cables connected to the I/O chassis

NOTE Be sure to identify each cable as you remove it. To make sure you put it back on the correct connector later, mark each cable with tape or by some other means so that it may readily identified later.

IMPORTANT Mark all cables.

- Step 1.** Disconnect all I/O cables from the I/O chassis at the front of the ICE.
- Step 2.** Pull the I/O cables from the ICE under the I/O chassis and pull them out the back of the IOX.
- Step 3.** Remove the left and right I/O fans by loosening the four T10 Torx screws on each fan and pulling them out of the chassis.

Figure 6-7 ICE Fan Removal

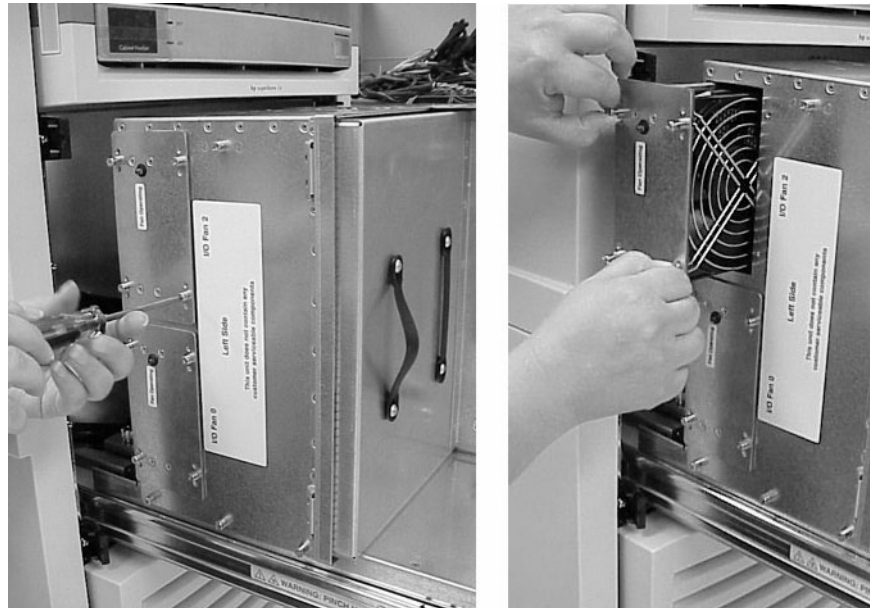

Step 4. Remove the fan shields to access the clock and REO cable connectors by loosening the four T10 Torx screws on each shield (two per ICE).

Figure 6-8 Removing Fan Shield



Step 5. Remove the REO strain relief brackets.

Step 6. Disconnect the REO and clock cable from both the left and right XMIOBs.

Figure 6-9 Removing REO and Clock Cables from XMIOBs

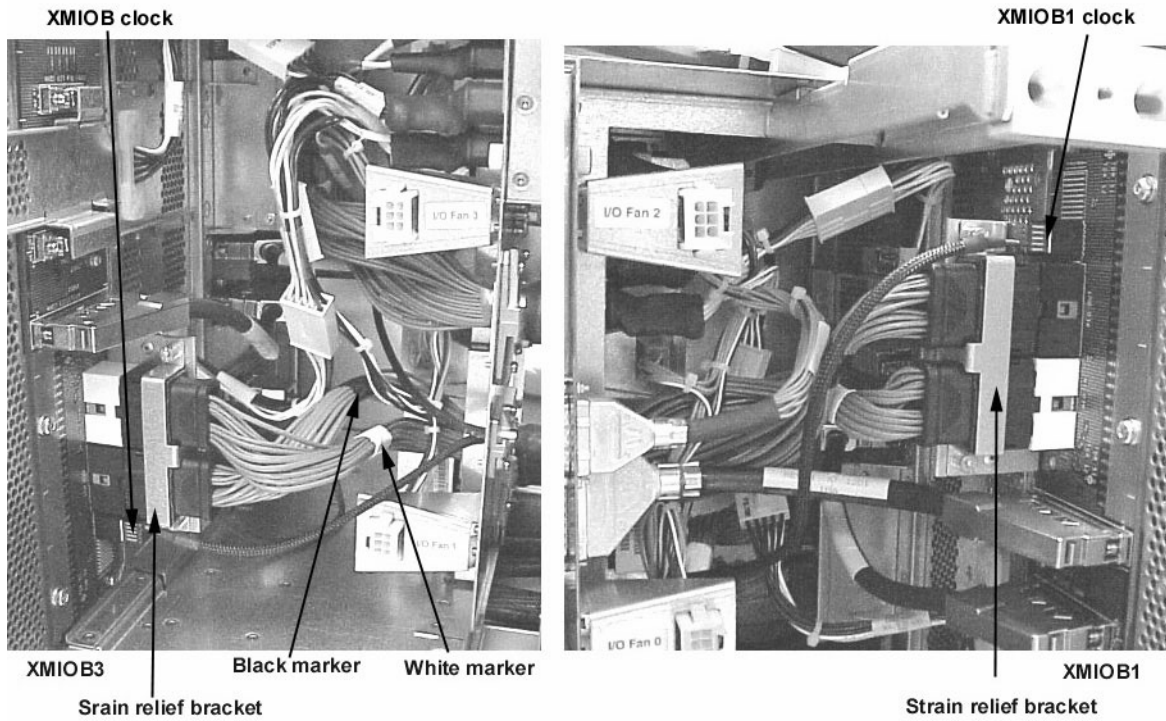

Step 7. Pull the REO cables from the ICE by removing the four screws around each ferrule and then by pulling the cable through the mounting holes. See Figure 6-10 for the locations of the ICE cables to be removed.

Figure 6-10 ICE Connector Locations

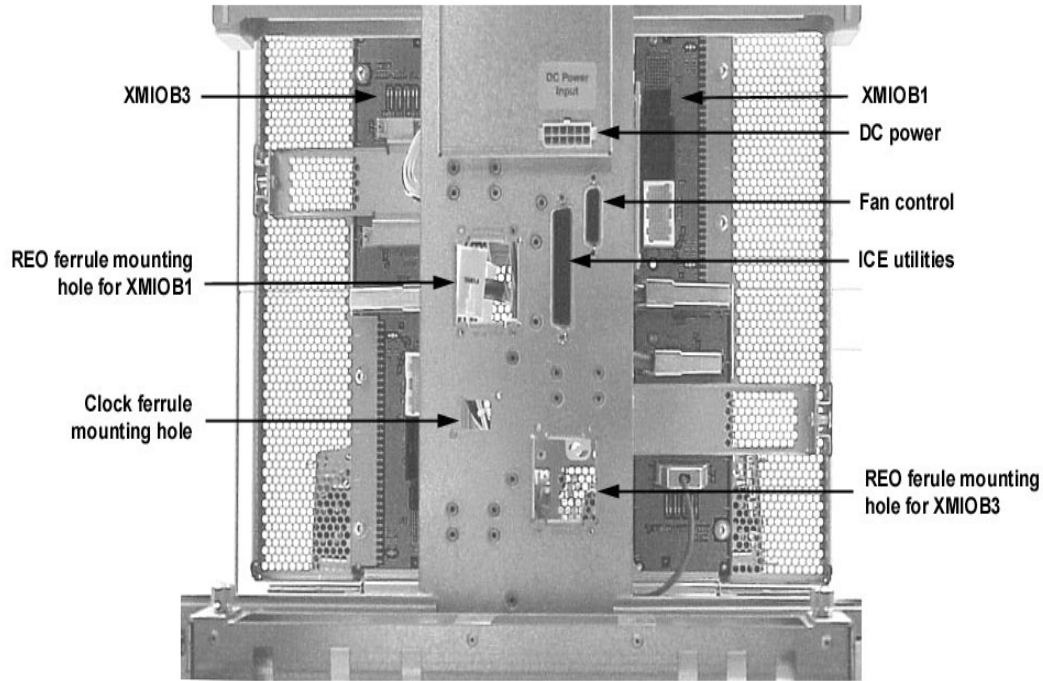

- Step 8.** Disconnect the clock cable by removing the screw around its ferrule and then pulling it through the mounting hole.
- Step 9.** Remove the I/O fan control cable at the top rear of the ICE back panel by loosening the two connector screws. See Figure 6-10.
- Step 10.** Remove the I/O Utilities Cable at the rear of the ICE by loosening the two connector screws. See Figure 6-10.

Removing the ICE

- Step 1.** Push the locking tabs on the ICE rack rails to unlock them and push the ICE tray back into the cabinet.

Figure 6-11 Pushing the ICE into the Cabinet



Step 2. Loosen the six rear, captive mounting brackets on each side of the IOX using two each (per bracket) T20 Torx screws.

Figure 6-12 ICE Rear Mounting Bracket



Step 3. Remove four T-20 Torx screws on the front ICE flange.

Figure 6-13 ICE Front Mounting Screws

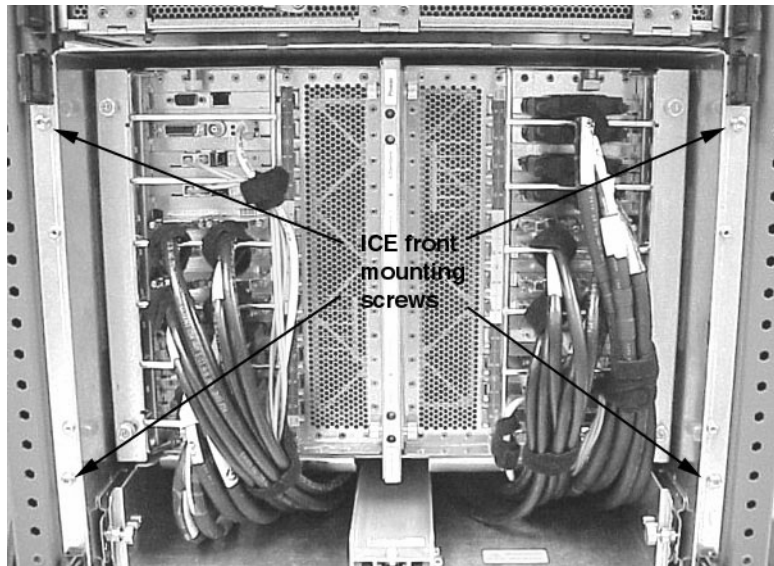

Step 4. Carefully slide and lift the ICE out of the cabinet.

WARNING Use two people or a lifting device as the unit is bulky as well as heavy.

Step 5. Place the ICE on an ESD approved workspace.

Replacing the ICE

Follow the procedures in the section “Mounting the ICE into the Rack” on page 91 and mount the ICE into the cabinet.

WARNING Use two people or a lifting device as the unit is bulky as well as heavy.

Connecting the Cables

Step 1. Locate the ends of the REO cables that has the ferrule attached.

NOTE Each REO cable has two connectors (input and output) that attach to each XMIOB. There are two XMIOBs per ICE, one for each I/O chassis, but you may only have one I/O chassis, and therefore, will only connect one pair of connectors to one XMIOB.

Step 2. Pass the cables over the cable management arm, under the cable strain relief arm, and run the connectors through the appropriate REO ferrule mounting hole(s).

Step 3. Remove the strain relief bracket.

Step 4. Push the ferrule(s) up to the mounting hole(s) and secure with four screws supplied.

Figure 6-14 REO Cable Ferrule Mounted in ICE

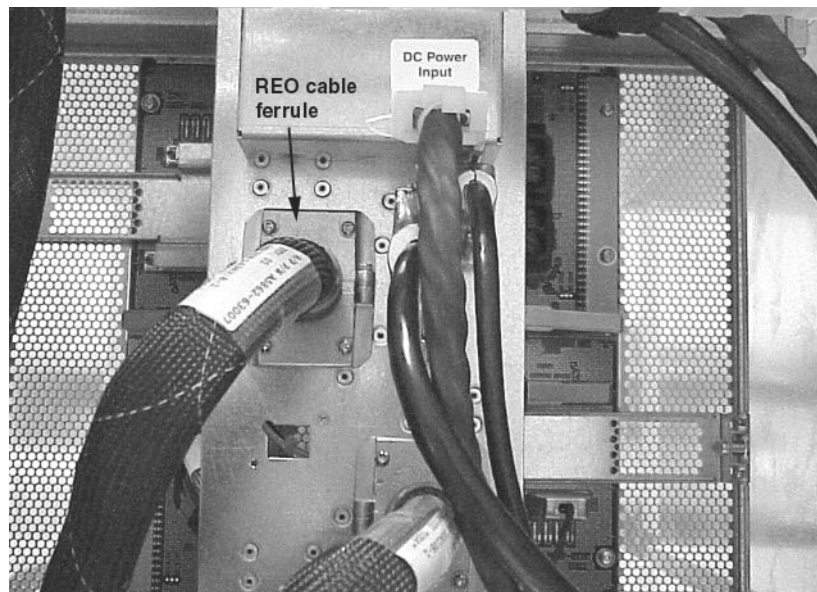

Step 5. Push the REO cable connectors into their respective connectors on the XMIOB.

IMPORTANT Install the REO cable with the white marker band to the white cable connector on the XMIOB.

Install the REO cable with the black cable marker band to the black connector on the XMIOB.

Figure 6-15 REO and Clock Connectors on the XMIOB



Step 6. Attach the strain relief bracket.

Re-installing the Fan shield

Step 1. Install the fan shields by tightening the four T10 Torx screws on each shield (two per ICE).

Figure 6-16 Installing ICE Fan Shields

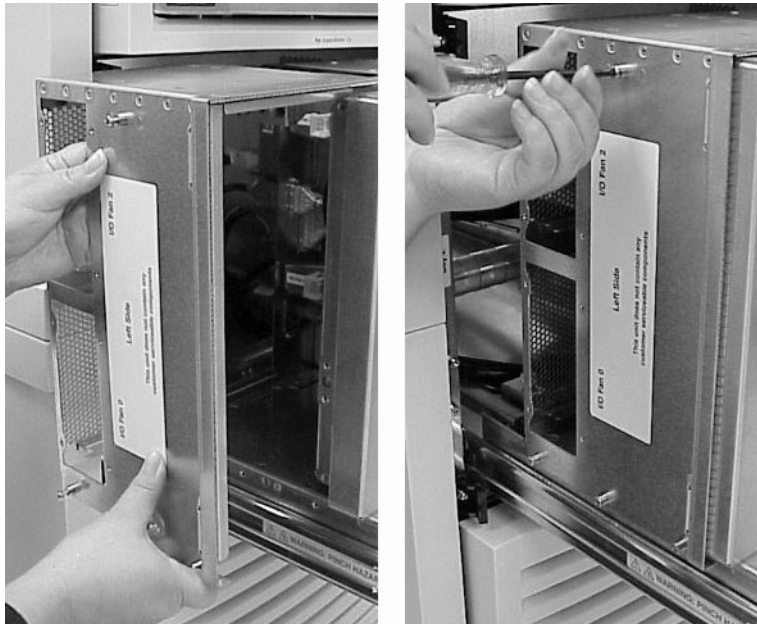

- Step 2.** Install the left and right I/O fans by pushing them onto the ICE and tightening the four T10 Torx screws. Insure that the EMI shielding is not damaged.

Figure 6-17 Installing Fans



- Step 3.** Disengage the ICE slide rail locking tabs and slide the ICE into the rack. The ICE tray retaining pins will automatically lock.
- Step 4.** Re-install the EMI panel by pressing it onto the ICE and tightening the four captive screws.
- Step 5.** Re-attach the cosmetic bezel to the ICE.
- Step 6.** Connect the DC power cable to the back of the ICE.

Removing and Replacing the ICE I/O chassis

Removing the I/O chassis

- Step 1.** Disable power to the ICE by removing AC the power connector on the rear of the XPC.
- Step 2.** Remove the front bezel from the ICE.

Figure 6-18 Removing the Front Bezel



- Step 3.** Remove the EMI panel from the ICE by loosening the four captive retaining screws.

Figure 6-19 Removing the EMI Cover



Step 4. Locate the I/O chassis to be removed.

Step 5. Remove all I/O cables from the I/O chassis.

IMPORTANT Be sure to identify each cable as you remove it. To make sure you put it back on the correct connector later, mark each cable with tape or by some other means so that it may readily identified later.

Figure 6-20 I/O Cables Connected to PCI Controllers

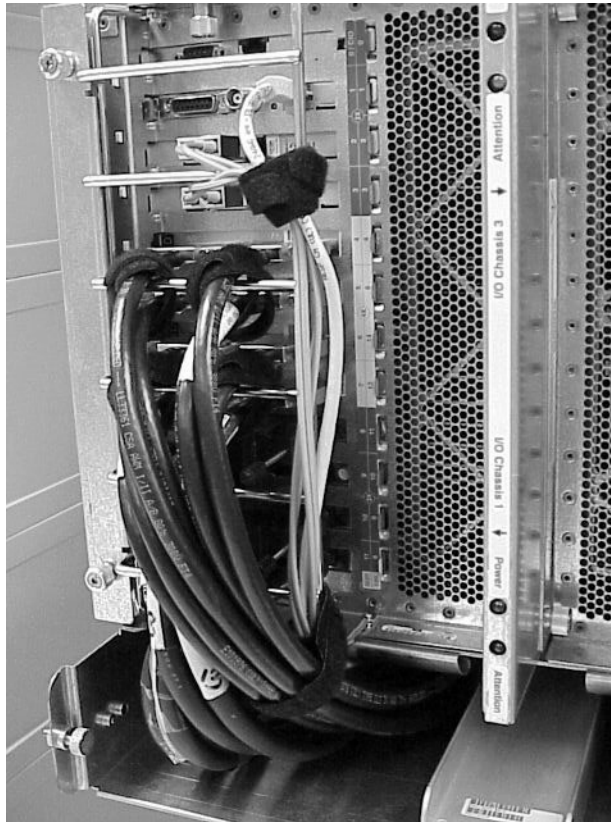

Step 6. Remove the I/O chassis by loosening its retaining screws and pulling it out of the ICE.

Figure 6-21 **Removing the I/O Chassis**

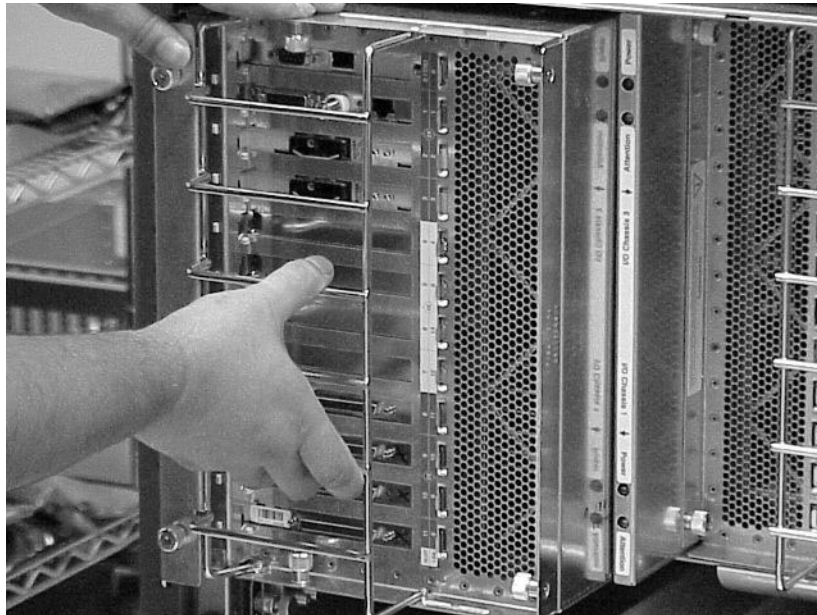

Step 7. Place the I/O chassis on an approved ESD work space and remove each PCI controller cards.

IMPORTANT Mark each card so that you will remember the slot locations.

Replacing the I/O Chassis

- Step 1.** Re-install all previously removed PCI controller cards in the I/O chassis.
- Step 2.** Re-install the I/O chassis lid.
- Step 3.** Install the replacement chassis by sliding it along the center separator wall until the guide pins engage and the connectors seat.
- Step 4.** Tighten the captive screws.
- Step 5.** Attach all the external I/O cables that were previously connected to the chassis.
- Step 6.** Install the ICE EMI panel.
- Step 7.** Deactivate the slide locks and push the ICE tray into the rack
- Step 8.** Lock the tray retaining pins
- Step 9.** Re-install the EMI panel by pressing it onto the ICE and tightening the four captive screws.
- Step 10.** Replace the front cosmetic panel.

Removing and Replacing the ICE Fan Module

Four (N+1) I/O fans mounted in the rear of the ICE provide cooling for the chassis. Air is pulled through the front as well as the I/O chassis lid (on the side of the ICE) and exhausted out the rear. The I/O fan assembly is hot-swappable. An LED on each I/O fan assembly indicates that the fan is operating.

Required Tools

The following is a list of tools required for ICE assembly and service operations:

- Anti-static mat with provisions for connecting to chassis ground
- Wrist strap
- T10 and T20 Torx bit
- Torx driver

Removing the ICE Fan

To remove the ICE fan, perform the following steps:

- Step 1.** Remove the front cosmetic bezel.
- Step 2.** Remove the front EMI panel by loosening the four T20 Torx screws.
- Step 3.** Retract the ICE tray retaining pins.
- Step 4.** Extend the ICE tray. With the tray extended, the fan modules are now accessible.
- Step 5.** Locate the fan to be removed.
- Step 6.** Loosen the four captive retaining screw.
- Step 7.** Remove the fan module.

Figure 6-22 ICE Fan Removal

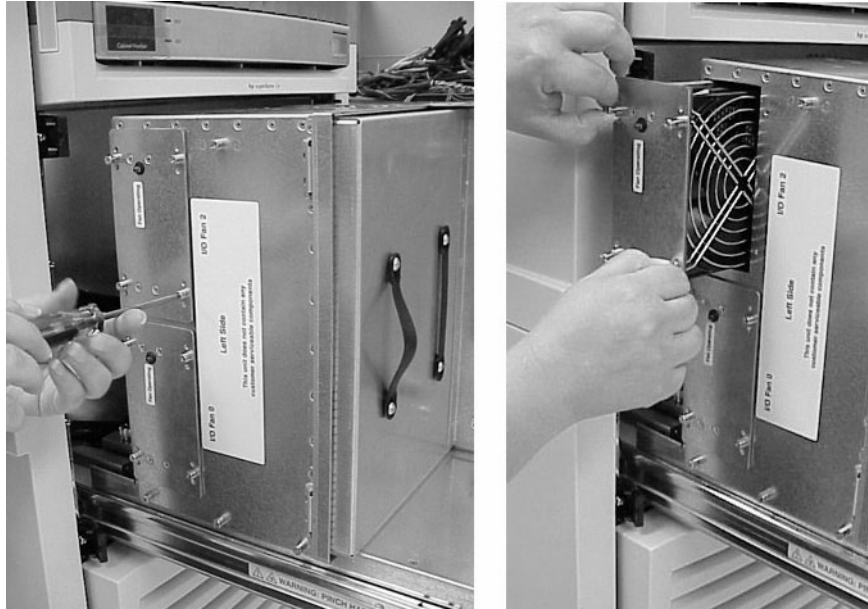

Replacing the Fan Module

- Step 1.** Install the replacement fan module by sliding it into its chassis. See Figure 6-22.
- Step 2.** Tighten the captive retaining screw.
- Step 3.** Press the locks on each of the two ICE rack slides and push the ICE chassis into the cabinet.
- Step 4.** Twist and lock the tray retaining pins.
- Step 5.** Re-attach the front EMI panel by tightening its four captive retaining screws.
- Step 6.** Install the front cosmetic bezel.

Removing and Replacing the ICE XMIOB

Removing the XMOIB

Perform the following procedure to replace the XIOMB:

Step 1. Disable power to the ICE by removing the DC power connector on the rear of the ICE.

Step 2. Remove the front bezel from the ICE.

Figure 6-23 Removing the Front Bezel



Step 3. Remove the EMI panel from the ICE by loosening the four captive retaining screws. This allows access to the ICE tray retaining pins.

Figure 6-24 **Removing the EMI Cover**



Step 4. Disengage the lock pins and slide out the ICE on its tray.

Figure 6-25 **Extending the ICE**



- Step 5.** Follow the procedures in the section, “Removing the I/O chassis” on page 132, and remove the I/O chassis in front of the XMIOB to be removed.
- Step 6.** Follow the procedure in the section, “Removing the ICE Fan” on page 135, and remove the two ICE fans nearest the XMIOB to be removed.
- Step 7.** Remove the fan shield to access the cable connected to the XMIOB by loosening the four T10 Torx screws on each shield (two per ICE). This allows access to the XMIOB.

Figure 6-26 Removing Fan Shield

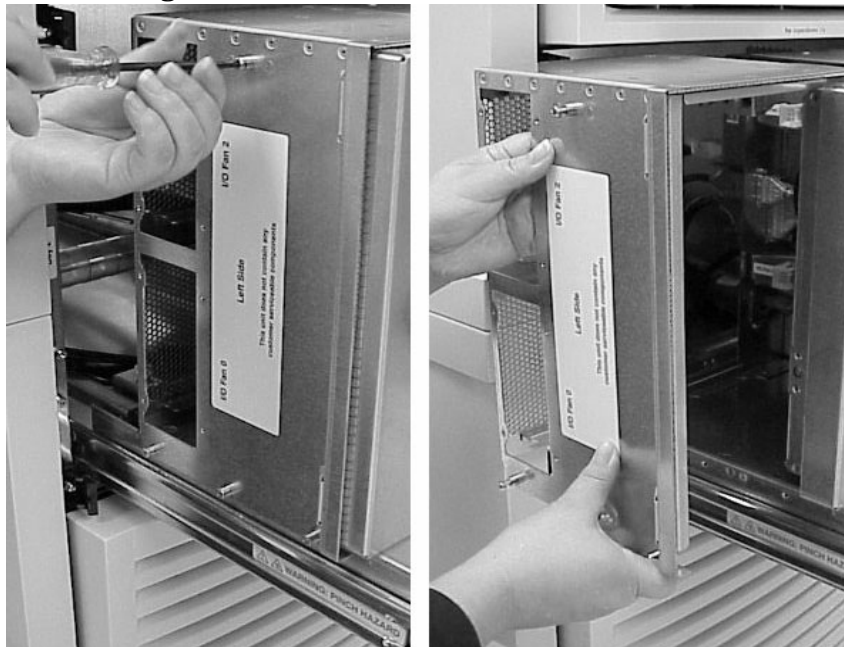

Step 8. Remove the REO cable strain relief brackets.

Step 9. Disconnect all cables connected to the XMIOB.

IMPORTANT Mark all cables before they are removed.

Step 10. Remove the screw retaining the XMIOB and slide it out of the ICE sideways.

Figure 6-27 XMIOB

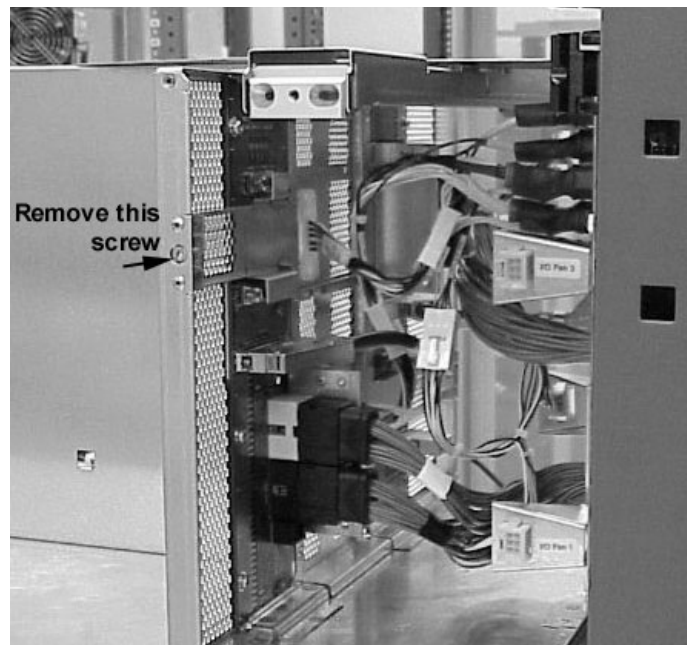

Figure 6-28 ICE XMIOB Location



Replacing the XMIOB

Perform the following procedure to replace the XMIOB:

- Step 1.** Insert the replacement XMIOB and tighten the retaining screw.
- Step 2.** Re-attach the previously removed cables to the XMIOB.
- Step 3.** Re-install the REO cable strain relief.
- Step 4.** Re-install the fan shield previously removed by tightening the four T20 Torx screws.
- Step 5.** Re-install the two fan modules and tighten the four T10 Torx screws on each of them.
- Step 6.** Re-install the I/O chassis by following the procedure outlined in “Replacing the I/O Chassis” on page 134 and re-install the chassis.
- Step 7.** Push in the slide rail locks and slide the ICE into the cabinet and tighten the tray locks.
- Step 8.** Re-attach the front EMI panel.
- Step 9.** Install the front cosmetic bezel.
- Step 10.** Connect the DC power cable to the ICE.

Removing and Replacing the XUC

Required Tools

The following is a list of tools required for IOX assembly and service operations:

- Anti-static mat with provisions for connecting to chassis ground
- Wrist strap
- T-20 Torx bit
- Torx drive extension
- Torx torque driver
- Flat-blade screwdriver

Removing the XUC

To remove the XUC, perform the XUC procedure:

- Step 1.** Disable power to the ICE by removing the DC power cable on the rear of the XUC.
- Step 2.** Verify that the power is off by observing the HK Power LED on the front panel display.
- Step 3.** Remove the front cosmetic bezel.

Figure 6-29 XUC Cosmetic Bezel



- Step 4.** Remove the two T-20 Torx screws retaining the chassis to the rack.
- Step 5.** Gently pull the XUC out from the cabinet until the slides lock.
- Step 6.** Remove the XUC side panel by loosening the six captive T10 Torx screws.
This panel allows access to the ICE clock and GSP bus connections.

Figure 6-30 Cable Access Panel

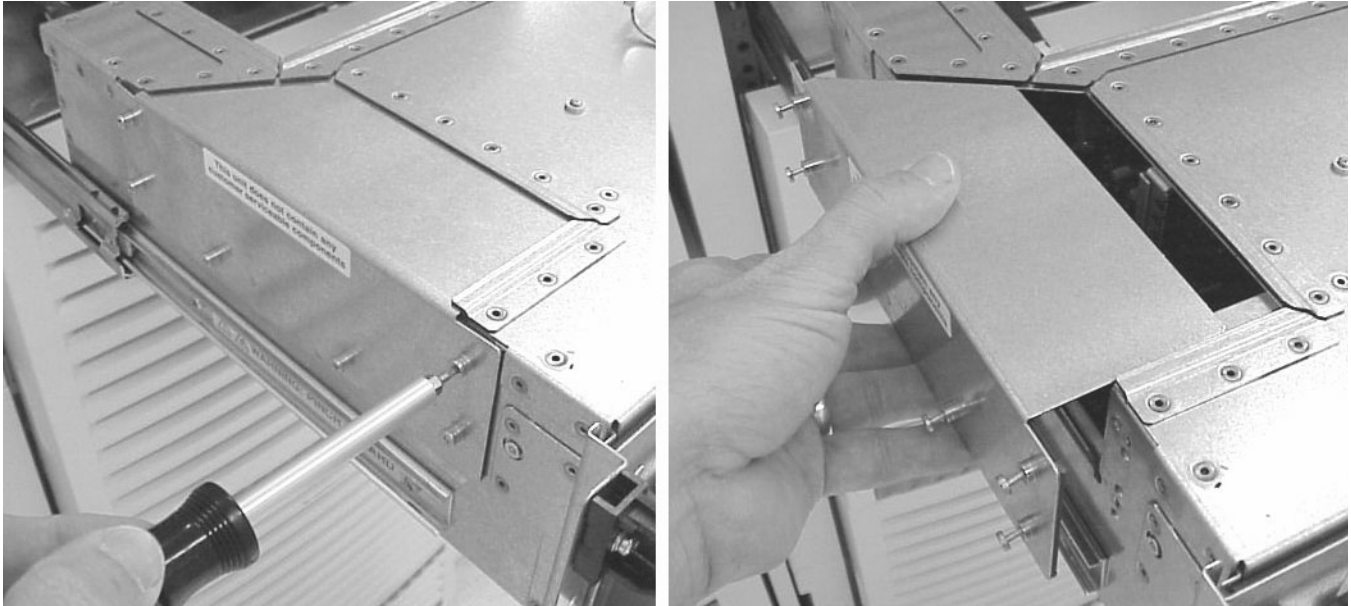

Step 7. Locate the ICE clock cables and GSP bus cable and remove them.

Figure 6-31 Clock and GSP Bus Cables

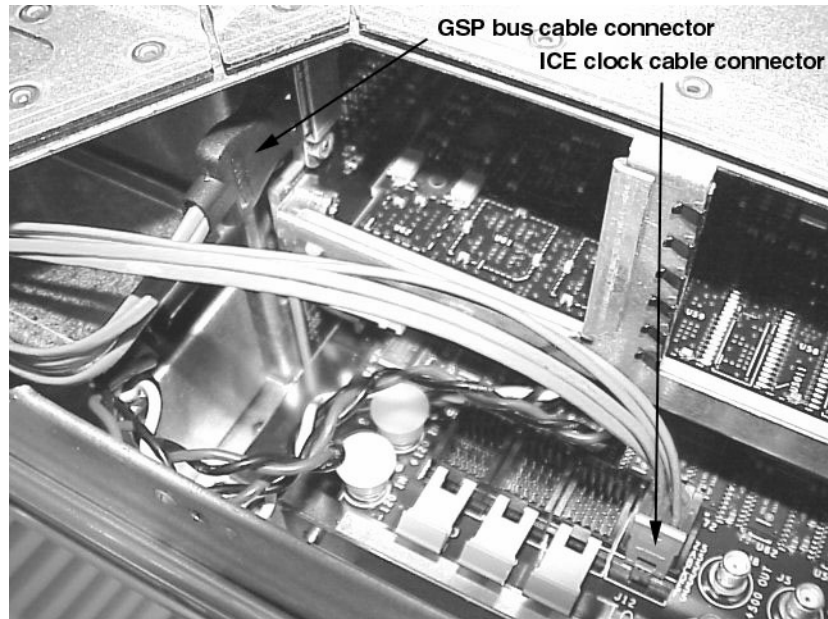

Step 8. Pull the ICE clock cables from the XUC through the ferrule mounting hole(s) by removing the two screws holding each 7 cable ferrule.

Step 9. Pull the GPS bus cable from the XUC through the ferrule mounting hole by removing the two screws holding the cable ferrules.

Step 10. Disconnect and remove all remaining cables on the back of the XUC.

IMPORTANT Be sure to identify each cable as you remove it. To make sure you put it back on the correct connector later, mark each cable with tape or by some other means so that it may readily be identified later.

Step 11. Press both slide locks to release the XUC and remove it from IOX cabinet.

Figure 6-32 XUC Extended

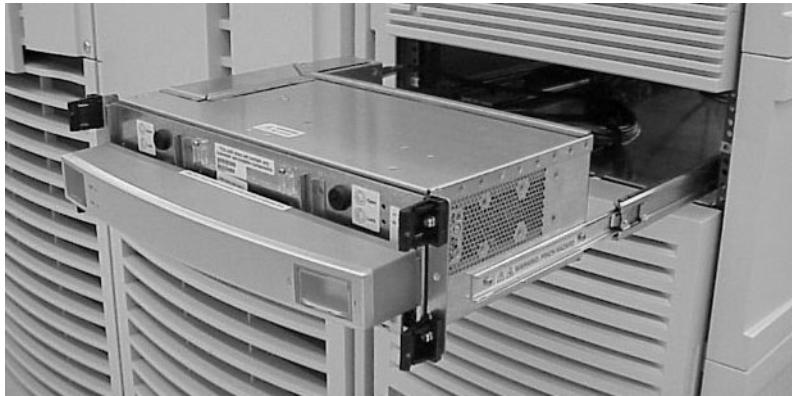

Step 12. Place the XUC on an ESD approved work space.

Step 13. Remove the slide rails attached to the sides of the XUC by removing the two T20 Torx screws holding each slide.

Replacing the XUC

Step 1. Attach the previously removed slides on each side of the XUC using the two T20 Torx screws on each side.

Step 2. Carefully place the mating slides on the XUC into the cabinet slides and push the XUC until the slides lock.

Step 3. Remove the XUC side panel by loosening the six captive T10 Torx screws.

This panel allows access to the ICE clock and GSP bus connections.

Step 4. Pass the ICE clock cables through the ferrule mounting hole and press them in to the appropriate connectors in the XUC.

Step 5. Attach the clock cable ferrule to the back of the XUC using the two T10 Torx screws.

Step 6. Pass the GSP bus cable through the ferrule mounting hole and press it in to the appropriate connectors in the XUC.

Step 7. Attach the GSP bus cable ferrule to the back of the XUC using the two T10 Torx screws.

Step 8. Install all remaining cables on the back of the XUC.

Step 9. Re-attach the XUC side panel by tightening the six T10 Torx screws

Removing and Replacing the XUC

Step 10. Press the slide locks to release the slides and push the XUC into the rack.

Step 11. Re-attach the cosmetic bezel to the XUC.

Step 12. Enable power to the XUC by connecting the DC power cable on the rear of the XPC.

Removing and Replacing the XUC Fan Module

Required Tools

The following is a list of tools required for IOX assembly and service operations:

- Anti-static mat with provisions for connecting to chassis ground
- Wrist strap
- T-20 Torx bit
- Torx drive extension
- Torx in-lb torque driver

Replacing the Fan Module

To replace the XUC fan module, perform the following procedure:

Step 1. Remove the front cosmetic bezel.

Figure 6-33 XUC Cosmetic Bezel



Step 2. Connect your ESD wrist strap to the ESD grounding lug on the front door of the XUC.

Figure 6-34 XUC ESD Grounding Lug

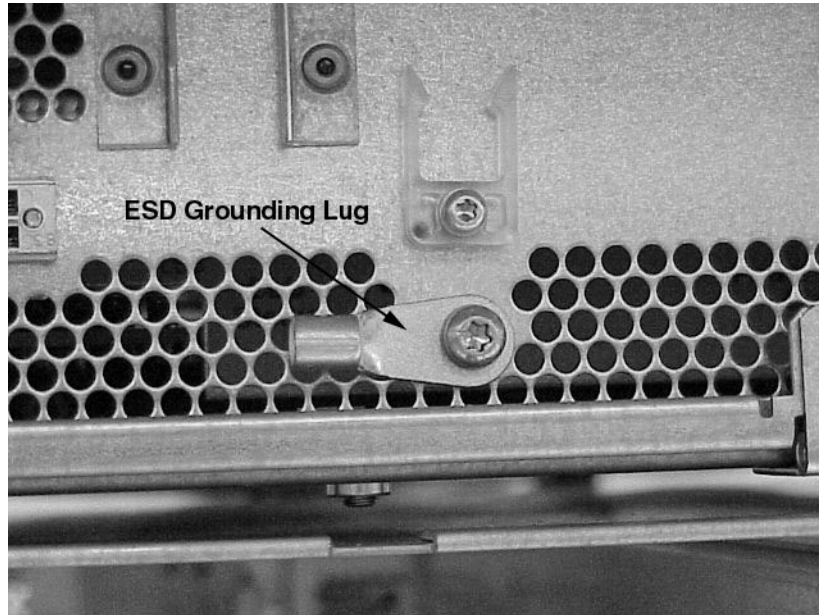

- Step 3.** Turn the two black slotted screws one-quarter turn counter-clockwise.
- Step 4.** Slide up the control panel assembly (CPA) until it latches.
- Step 5.** Open the door.

Figure 6-35 CPA Assembly Removal

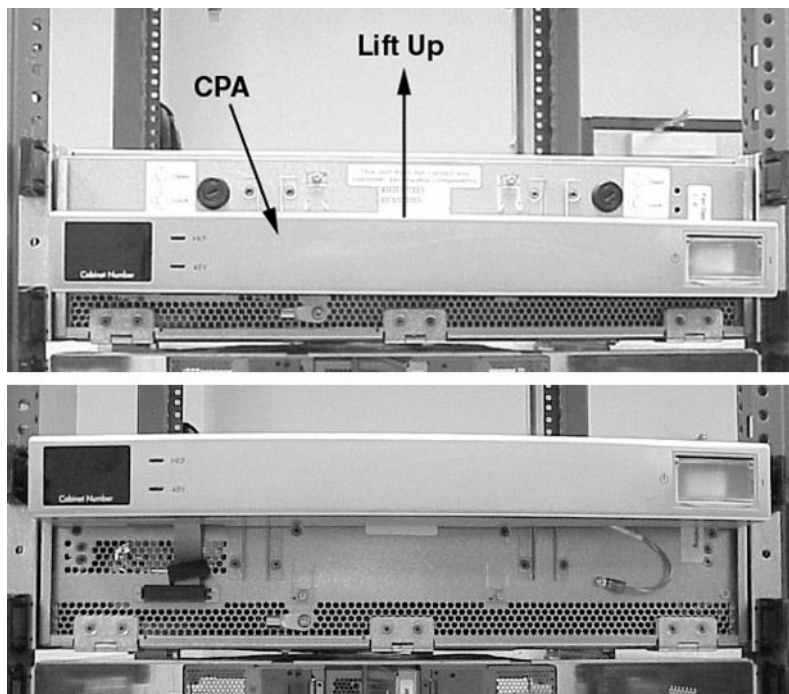

- Step 6.** Loosen the captive screw on the fan module.

Step 7. Remove fan module.

Figure 6-36 XUC Fan Replacement

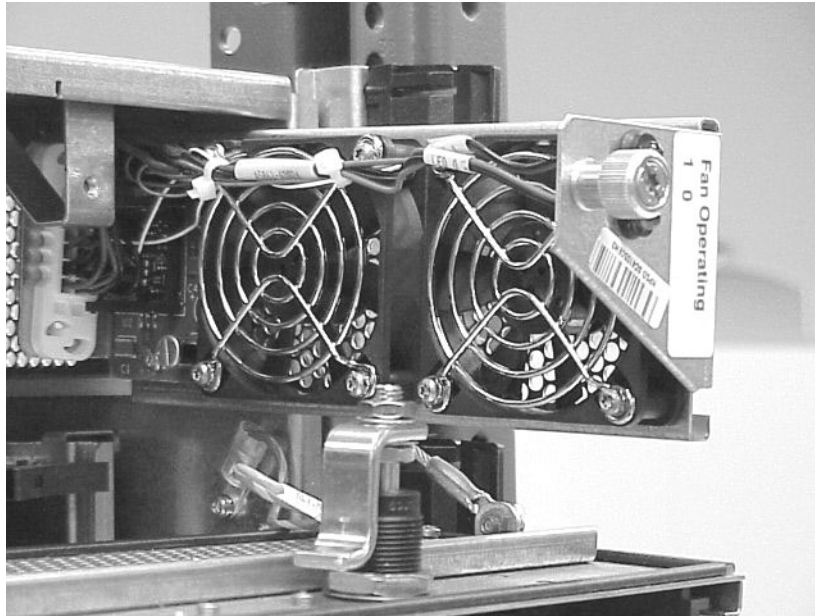

Replacing the XUC Fan Module

- Step 1.** Connect your ESD wrist strap to the ESD grounding lug of the XUC.
- Step 2.** Install replacement fan module.
- Step 3.** Fasten the captive screw on the fan module.
- Step 4.** Close the door until the magnetic latch engages.
- Step 5.** Lower the CPA until it latches.
- Step 6.** Turn the two black slotted screws one-quarter turn clockwise.
- Step 7.** Reinstall the cosmetic bezel.

Removing and Replacing the PM/CLU (UGUY)

Required Tools

The following is a list of tools required for IOX assembly and service operations:

- Anti-static mat with provisions for connecting to chassis ground
- Wrist strap
- T-20 Torx bit
- Torx drive extension
- Torx in-lb torque driver

Removing the PM/CLU

To replace the PM/CLU, perform the following procedure:

- Step 1.** Remove both AC power cables on the rear of the XPC.
- Step 2.** Remove the front bezel from the XUC by grasping the indentions on both sides of the bezel and pulling toward you.
- Step 3.** Remove the two T-20 Torx screws retaining the chassis to the rack.
- Step 4.** Gently pull the XUC out from the cabinet until the slides lock.
- Step 5.** Remove the XUC side panel by loosening the six captive T10 Torx screws.
This panel allows access to the ICE clock and GSP bus connections.

Figure 6-37 Cable Access Panel

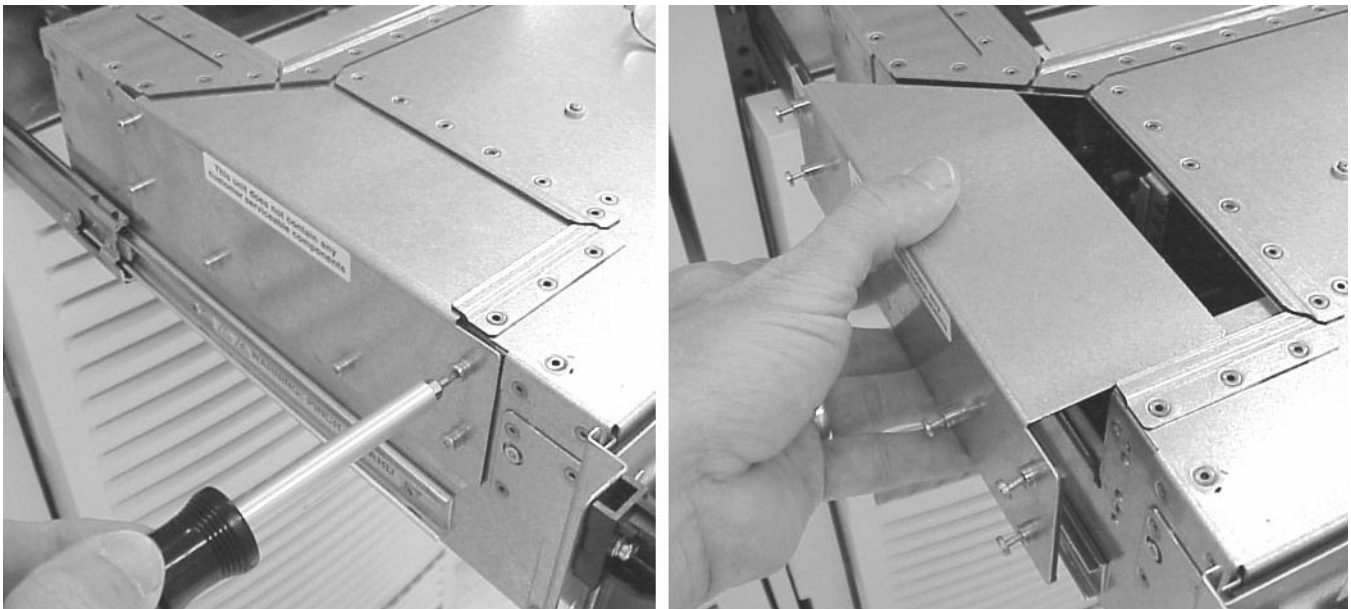

Step 6. Connect your ESD wrist strap to the ESD grounding lug on the XUC door.

Step 7. Locate the ICE clock cables and remove it.

Figure 6-38 Clock and GSP Bus Cables

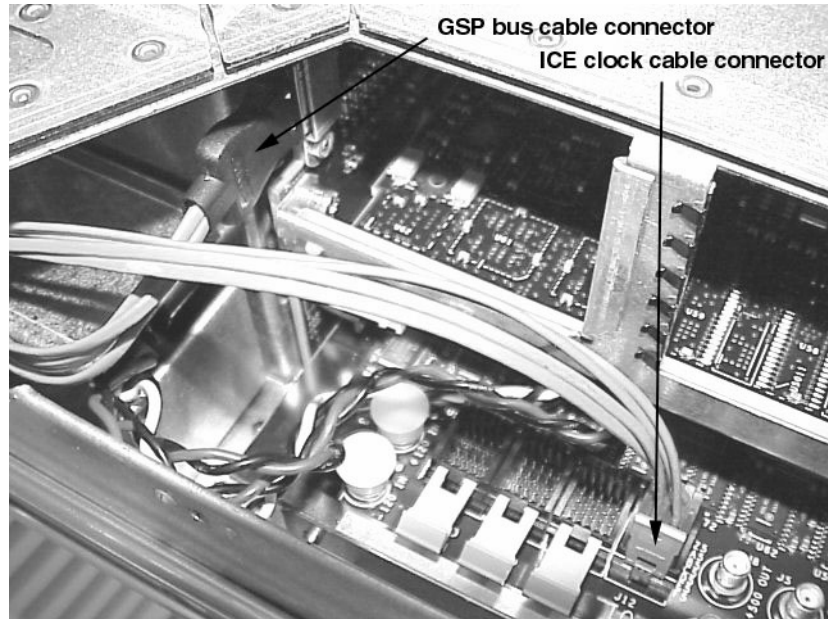

Step 8. Pull the ICE clock cables from the XUC through the ferrule mounting hole(s) by removing the two screws holding the cable ferrule.

Step 9. Unlock the cover and move up the CPA bezel up.

Step 10. Lower the EMI cover as shown in Figure 6-39.

Step 11. Remove the PM/CLU using the ejector mechanism.

Figure 6-39 PM/CLU Replacement

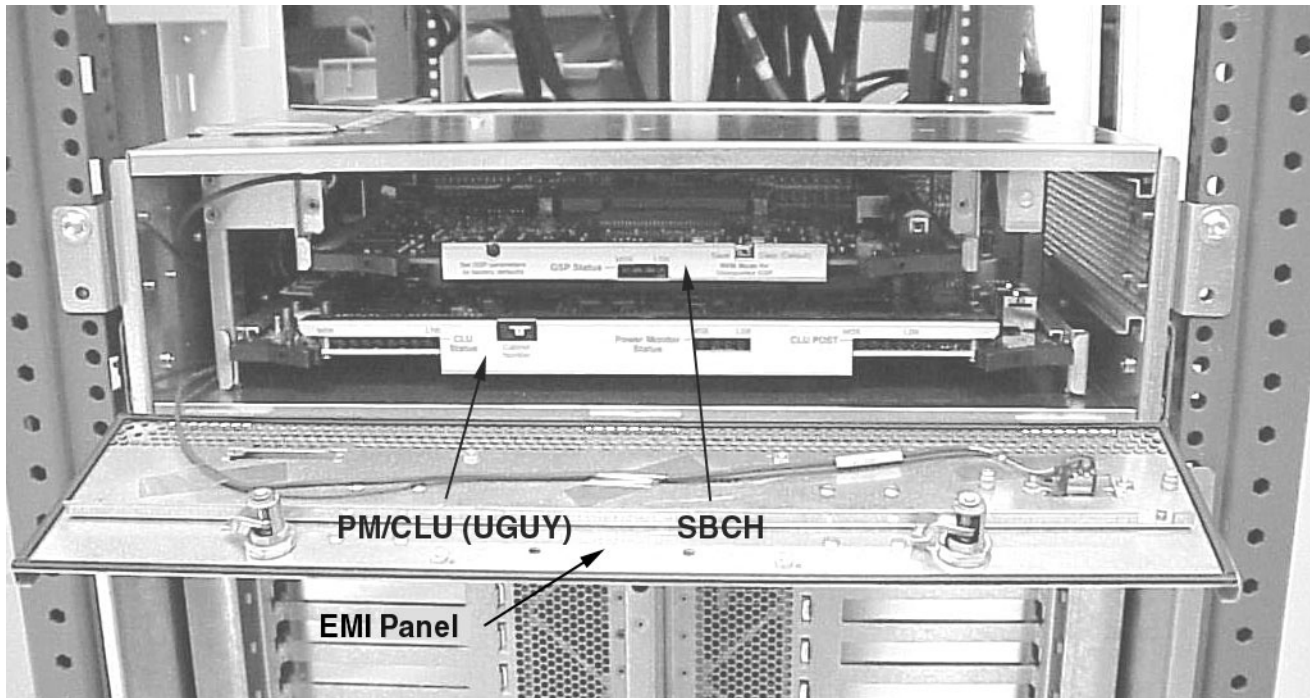

Replacing the PM/CLU

To replace the PM/CLU, preform the following steps:

- Step 1.** Connect your ESD wrist strap to the ESD grounding lug on the XUC door.
- Step 2.** Install the replacement PM/CLU board.
- Step 3.** Set the cabinet number to appropriate value (8 or 9).
- Step 4.** Attach the clock cable ferrule to the back of the XUC using the two T10 Torx screws.
- Step 5.** Re-attach the XUC side panel by tightening the six T10 Torx screws
- Step 6.** Press the slide locks to release the slides and push the XUC into the rack.
- Step 7.** Close the front EMI cover.
- Step 8.** Slide down the CPA bezel and lock the cover.
- Step 9.** Disconnect you ESD strap.
- Step 10.** Replace the cosmetic bezel.
- Step 11.** Re-connect the AC power cord to the XPC.
- Step 12.** Switch on the IOX power.

Replacing the SBCHL (Lite)

Perform the following procedure to replace the SBCHL:

- Step 1.** Remove the front cosmetic bezel of the XUC.
- Step 2.** Connect your ESD wrist strap to the ESD grounding lug on the XUC door.
- Step 3.** Unlock the cover and slide up the CPA bezel.
- Step 4.** Lower the front EMI cover.
- Step 5.** Remove SBCHL using ejector mechanism.
- Step 6.** Install replacement board.
- Step 7.** Close the EMI cover.
- Step 8.** Slide down the CPA bezel and lock the cover.
- Step 9.** Reinstall the cosmetic bezel.

Figure 6-40 SBCHL Replacement

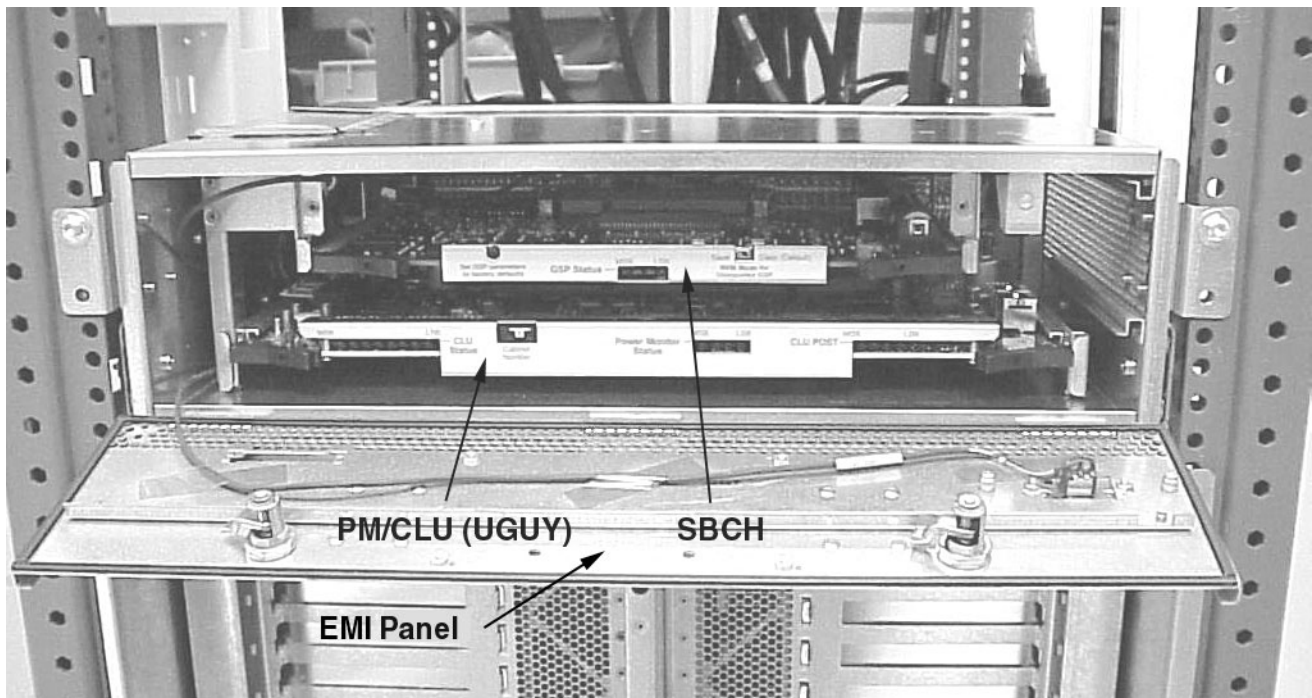

Removing and Replacing the XPC

Required Tools

The following is a list of tools required for IOX assembly and service operations:

- Anti-static mat with provisions for connecting to chassis ground
- Wrist strap
- T-20 Torx bit
- Torx drive extension
- Torx in-lb torque driver

Removing a XPC

To remove the XPC, perform the following procedure:

- Step 1.** Open the rear door
- Step 2.** Remove the front XPC cosmetic bezel.
- Step 3.** Remove the AC power cord(s) from the back of the XPC.
- Step 4.** Remove all cables from the rear of the XPC.

IMPORTANT Be sure to identify each cable as you remove it. To make sure you put it back on the correct connector later, mark each cable with tape or by some other means so that it may readily identified later.

- Step 5.** Remove the ground cable from the rear lug.
- Step 6.** Loosen the BPS safety latch located at the front and top of the XPC.
- Step 7.** Remove the two BPSs from the XPC by pulling the handle on each.

You must loosen and move the safety latch first one direction and then the other to remove both BPSs.

Figure 6-41 Two BPSs located in XPC

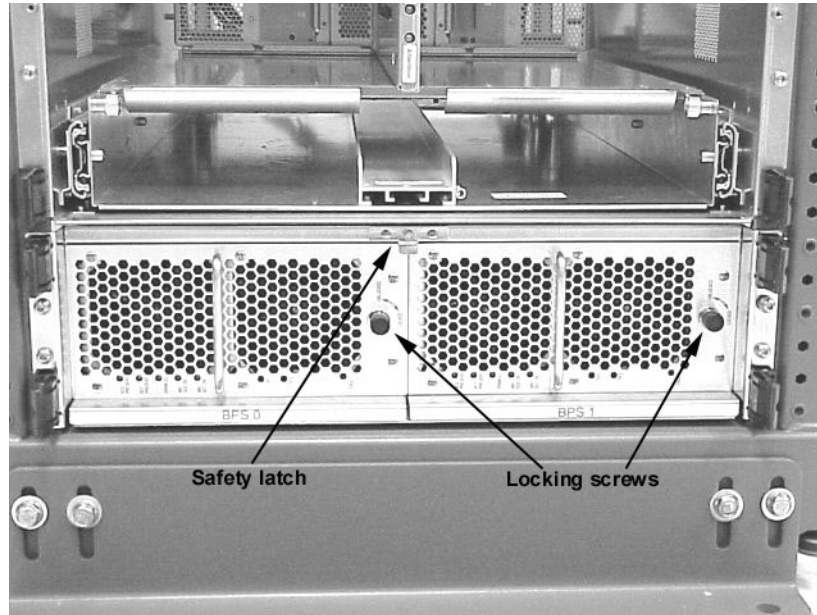

Step 8. Remove the rear mounting bracket.

Step 9. Remove the four T-20 Torx screws on the front of the XPC and slide it out of the cabinet rack.

Replacing the XPC

Step 1. Make sure the snap-on locking nuts on the rack are aligned with the holes on the front and rear of the XPC

Step 2. Carefully place the XPC into the front of the rack and slide it back until it is flush with the edge of the rack mounting holes.

Step 3. Install the four front T-20 Torx screws and tighten.

Step 4. Install the rear mounting bracket.

Step 5. Install the two BPSs by carefully sliding them into the XPC using the handles on each.

Step 6. Reconnect all cables that were previously removed.

Step 7. Replace the cosmetic bezel.

Step 8. Close the rear door.

Removing and Replacing the BPS

Required Tools

Tabs and slots minimize fastener count and aid in assembly and service operations. The XPC uses retained and self-locking hardware throughout.

Removing a BPS

To remove the XPC, perform the following procedure:

- Step 1.** Remove the front XPC cosmetic bezel.
- Step 2.** Loosen the BPS safety latch located at the front and top of the XPC.
- Step 3.** Loosen the locking screw.
- Step 4.** Remove the BPS from the XPC by pulling the handle.

You must loosen and move the safety latch to the opposite direction to remove the BPS.

Figure 6-42 Two BPSs located in XPC

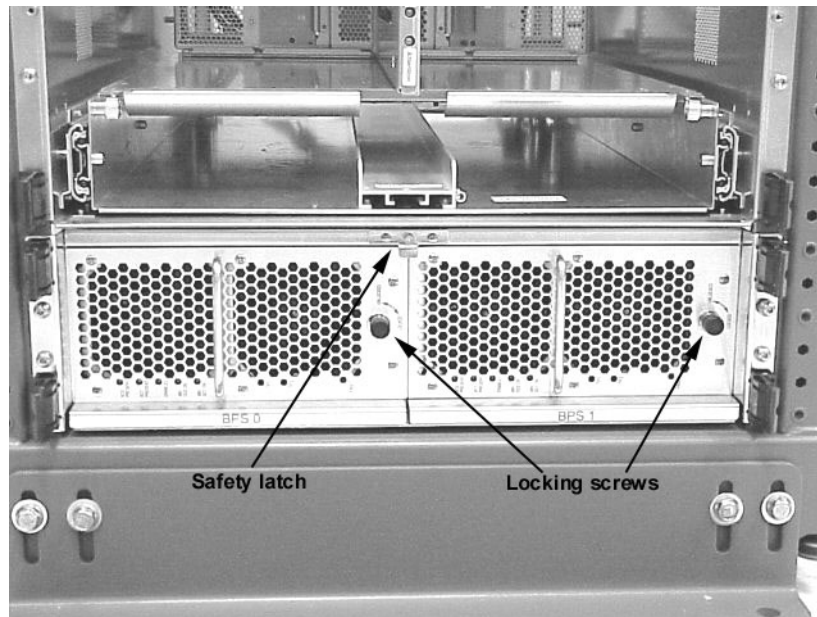

Replacing the BPS

- Step 1.** Slide the new BPS into its slot in the XPC using the handle.
- Step 2.** Tighten the locking screw on the BPS.
- Step 3.** Replace the cosmetic bezel.

7 Testing the IOX

Checking I/O Expansion Cabinet Status

This section describes the tools and procedures for listing details about I/O Expansion cabinets connected to an HP Superdome server.

Details are in the following subsections:

- “Tools for Listing I/O Expansion Cabinet Status” on page 156
- “Table of Procedures” on page 158
- “Listing Power and Fan Status for I/O Expansion Cabinets” on page 159
- “Listing Chassis or PCI Slot Populations for I/O Expansion Cabinets” on page 162
- “Listing Cell and Partition Connections for I/O Expansion Cabinets” on page 165

Throughout the commands and procedures, I/O Expansion cabinets are cabinets number 8 and 9.

Tools for Listing I/O Expansion Cabinet Status

Table 7-1 presents the tools for listing status details about I/O Expansion cabinets: the GSP Command menu, Boot Console Handler (BCH), and HP-UX commands.

Table 7-1 Tools for Listing I/O Expansion Cabinet Status

Tool	I/O Expansion Status Features
GSP Command Menu	<p>The GSP Command menu has these cabinet listing features.</p> <ul style="list-style-type: none"> • The DU command lists all cabinets in the server complex. • The IO command lists all cells-to-I/O chassis connections. • The PS command lists detailed power and hardware status for cabinets (Compute and I/O Expansion cabinets), cells, and other hardware.
Boot Console Handler (BCH)	<p>The BCH interface allows you to get partition-level information through the partition’s console before HP-UX has booted on the partition.</p> <p>The BCH Information menu IO command lists all active I/O chassis, the cells to which they are connected, and PCI devices and paths.</p>

Table 7-1 Tools for Listing I/O Expansion Cabinet Status

Tool	I/O Expansion Status Features
HP-UX Commands	<p>HP-UX commands allow you to list details about cabinet components either within the local partition or throughout the entire server complex.</p> <ul style="list-style-type: none">• The <code>parstatus -B</code> and <code>parstatus -v -b#</code> commands provide a summary of all cabinets (-B) and detailed info about a specified cabinet (-v -b#) within the server complex.• The <code>parstatus -I</code> command lists all I/O chassis within the entire server complex and any cell connections, and the <code>parstatus -C</code> command lists all cells within the entire complex and any I/O connections.• The <code>rad -q</code> command lists the <i>active</i> I/O chassis and PCI slot details for the <i>local partition</i> only.• The Partition Manager and SAM utilities also provide the above capabilities.

Table of Procedures

Table 7-2 summarizes procedures for getting I/O Expansion cabinet status. These procedures are described in detail in the sections that follow.

Table 7-2 I/O Expansion Cabinet Status Procedures

Procedure	Tools and Steps
Listing Power and Fan Status for I/O Expansion Cabinets	GSP Command menu: DU command and PS command. HP-UX: parstatus -B command and parstatus -v -b# command
Listing Chassis or PCI Slot Populations for I/O Expansion Cabinets	GSP Command menu: PS command. BCH interface: Information menu, IO command. HP-UX: parstatus -I (<i>complex-wide status</i>) and rad -q (<i>local partition status</i>) commands.
Listing Cell and Partition Connections for I/O Expansion Cabinets	GSP Command menu: IO command. BCH: Information menu, IO command. HP-UX: parstatus -I command or parstatus -C command.

Listing Power and Fan Status for I/O Expansion Cabinets

You can get power and fan status information for I/O Expansion cabinets using the following methods:

- “GSP” on page 159

This procedure (GSP Command menu, DU command or PS command, B option) checks power and fan status from the Guardian Service Processor (GSP) command menu.

- “HP-UX Commands” on page 160

This procedure (parstatus -B or parstatus -V -b#) lists the status of power supplies and fans from HP-UX.

I/O Expansion cabinets are numbered 8 and 9.

GSP

This procedure (GSP Command menu, **DU** command or **PS** command, **B** option) checks power and fan status from the Guardian Service Processor (GSP) command menu.

Step 1. Log in to the complex’s GSP and access its command menu.

From the GSP main menu, enter **CM** to access the command menu.

Step 2. For brief status, issue the **DU** command.

For detailed status, issue the **PS** command, select **B** for cabinet info, and specify the cabinet number whose status you want to check.

Checking I/O Expansion Cabinet Status

```
GSP:CM> DU
The following GSP bus devices were found:
+-----+-----+-----+-----+-----+-----+-----+-----+
| Cab. |      |      |      |      |      |      |      |      |      |      |      |      |      |      |      |      |      |      |      |      |      |
| #    | GSP  | CLU  | PM   | 0    | 1    | 2    | 3    | 4    | 5    | 6    | 7    | IO Bay | IO Bay | IO Bay | IO Bay | IO Bay | IO Bay | IO Bay | IO Bay |
|      |      |      |      | Chas. | Chas. | Chas. | Chas. | Chas. | Chas. | Chas. | Chas. | 0      | 1      | 2      | 3      | 0      | 1      | 2      | 3      |
|      |      |      |      | 0 1 2 3 | 0 1 2 3 | 0 1 2 3 | 0 1 2 3 | 0 1 2 3 | 0 1 2 3 | 0 1 2 3 | 0 1 2 3 | 0 1 2 3 | 0 1 2 3 | 0 1 2 3 | 0 1 2 3 | 0 1 2 3 | 0 1 2 3 | 0 1 2 3 |
+-----+-----+-----+-----+-----+-----+-----+-----+
| 0    | *    | *    | *    | *    | *    | *    | *    | *    | *    | *    | *    | *    | *    | *    | *    | *    | *    | *    | *    |
| 1    |      | *    | *    | *    | *    | *    | *    | *    | *    | *    | *    | *    | *    | *    | *    | *    | *    | *    | *    |
| 8    |      | *    | *    | *    | *    | *    | *    | *    | *    | *    | *    | *    | *    | *    | *    | *    | *    | *    | *    |
+-----+-----+-----+-----+-----+-----+-----+-----+
GSP:CM> PS
You may display detailed power and hardware status for the following items:
    B - Cabinet (UGUY)
    C - Cell
    G - GSP
    I - Core IO
    Select Device: b
    Enter cabinet number: 8
HW status for IO expansion cabinet #8: NO FAILURE DETECTED
Power switch: on; Power: enabled, good
Redundancy state: fans redundant, BPSs redundant
+-----+-----+-----+-----+-----+-----+
|      |      |      |      |      |      |      |      |      |      |      |      |      |      |      |      |      |      |      |      |      |
|      | IO Bay 0 | IO Bay 1 | IO Bay 2 | IO Bay 3 |      |      |      |      |      |      |      |      |      |      |      |      |      |      |      |
|      | Chassis | Chassis | Chassis | Chassis |      |      |      |      |      |      |      |      |      |      |      |      |      |      |      |
|      | 0 1 2 3 | 0 1 2 3 | 0 1 2 3 | 0 1 2 3 |      |      |      |      |      |      |      |      |      |      |      |      |      |      |      |
+-----+-----+-----+-----+-----+-----+-----+-----+
| Populated | * * | * * | * * | * * |      |      |      |      |      |      |      |      |      |      |      |      |      |      |      |
| Power Enabled | * * | * * | * * | * * |      |      |      |      |      |      |      |      |      |      |      |      |      |      |      |
| Powered On | * * | * * | * * | * * |      |      |      |      |      |      |      |      |      |      |      |      |      |      |      |
| Power Fault |      |      |      |      |      |      |      |      |      |      |      |      |      |      |      |      |      |      |      |
| Attention LED |      |      |      |      |      |      |      |      |      |      |      |      |      |      |      |      |      |      |      |
+-----+-----+-----+-----+-----+-----+-----+-----+
|      |      |      |      |      |      |      |      |      |      |      |      |      |      |      |      |      |      |      |      |      |
|      | XUC | IO Bay 0 | IO Bay 1 | IO Bay 2 | IO Bay 3 |      |      |      |      |      |      |      |      |      |      |      |      |      |      |      |
|      | 0 1 | 0 1 2 3 | 0 1 2 3 | 0 1 2 3 | 0 1 2 3 |      |      |      |      |      |      |      |      |      |      |      |      |      |      |      |
+-----+-----+-----+-----+-----+-----+-----+-----+
| Populated | * * | * * * * | * * * * | * * * * | * * * * |      |      |      |      |      |      |      |      |      |      |      |      |      |      |
| Failed |      |      |      |      |      |      |      |      |      |      |      |      |      |      |      |      |      |      |      |      |
+-----+-----+-----+-----+-----+-----+-----+-----+
-- Press <CR> to continue, or 'Q' to Quit --
```

HP-UX Commands

This procedure (**parstatus -B** or **parstatus -V -b#**) lists the status of power supplies and fans from HP-UX.

Step 1. Log in to HP-UX running on any of the system’s hard partitions.

You can check power and fan details from HP-UX running on any partition.

Step 2. Issue the **parstatus -B** command for a brief summary of all cabinets including fan status, or issue the **parstatus -V -b#** command for detailed fan status for a specific cabinet (-b#) whose details you want to view.

- The **parstatus -B** command summarizes the power and fan status for all cabinets in the system complex.
- The **parstatus -V -b#** command displays a detailed status (“ok” or “failed”) for all power supplies and fans in the specified cabinet (-b#).

The following example shows power and fan details for cabinet number 8, an I/O Expansion

cabinet.

```

# parstatus -v -b8
[Cabinet]
          Cabinet  I/O      Bulk Power  Backplane
          Blowers  Fans      Supplies   Power Boards
          OK/      OK/      OK/        OK/
Cab      Failed/   Failed/   Failed/     Failed/
Num Cabinet Type N Status  N Status  N Status   N Status   GSP
====  =====  =====  =====  =====  =====  =====
 8 SD64000      2/ 0/ N+  4/ 0/ N+  2/ 0/ N+   ?/ ?/ N-   none

Cabinet Blowers
=====
Fan 0 ok
Fan 1 ok

I/O Fans
=====
Fan 0 ok
Fan 1 ok
Fan 2 ok
Fan 3 ok

Bulk Power Supplies (BPS)
=====
Power Supply 0 ok
Power Supply 1 ok

Notes: N+ = There are one or more spare items (fans/power supplies).
       N  = The number of items meets but does not exceed the need.
       N- = There are insufficient items to meet the need.
       ?  = The adequacy of the cooling system/power supplies is unknown.

#

```

Listing Chassis or PCI Slot Populations for I/O Expansion Cabinets

You can list which I/O chassis are installed in I/O Expansion cabinets, and which PCI slots are populated in the chassis, using these methods:

- “GSP” on page 162

This procedure (GSP Command menu, PS command, B option) lists I/O chassis population from the Guardian Service Processor (GSP) Command menu.

- “BCH” on page 162

This procedure (BCH Information menu, IO command) lists I/O chassis and PCI slot information for currently active I/O chassis in the local partition.

- “HP-UX” on page 163

This procedure (parstatus -I or rad -q commands) lists complex-wide I/O chassis details or local partition PCI slot details from HP-UX running on a partition.

I/O Expansion cabinets are cabinets number 8 and 9.

GSP

This procedure (GSP Command menu, **PS** command, **B** option) lists I/O chassis population from the Guardian Service Processor (GSP) Command menu.

Step 1. Log in to the complex’s GSP and access its Command menu.

From the GSP main menu, enter **CM** to access the Command menu.

Step 2. Issue the **PS** command, select **B** for cabinet info, and specify the cabinet number whose status you want to check.

The I/O chassis population details are listed in the **PS** command’s output.

BCH

This procedure (BCH Information menu, **IO** command) lists I/O chassis and PCI slot information for *currently active* I/O chassis in the *local* partition.

Step 1. Access the BCH interface for the partition whose IO details you want, and access the Information menu.

Step 2. Enter the **IO** command from the BCH Information menu.

The **IO** command lists which I/O chassis are connected to which *active* cells in the *local* partition,

and for each chassis it lists the PCI slots and any devices attached to the slots.

```

Information Menu: Enter command > IO
I/O CHASSIS INFORMATION

    Cell Info          I/O Chassis Info
Cell  Cab/Slot        Cab   Bay   Chassis
-----
 10   1/2             1    1    3

I/O MODULE INFORMATION

Type          Path          Slot   Rope   HVERSION   SVERSION   IODC
-----
System Bus Adapter  10/0          0      0     0x8040     0x0c18     0x00
Local Bus Adapter  10/0/0        0      0     0x7820     0x0a18     0x00
Local Bus Adapter  10/0/1        1      1     0x7820     0x0a18     0x00
Local Bus Adapter  10/0/2        2      2     0x7820     0x0a18     0x00
Local Bus Adapter  10/0/3        3      3     0x7820     0x0a18     0x00
Local Bus Adapter  10/0/4        4      4     0x7820     0x0a18     0x00
Local Bus Adapter  10/0/6        5      6     0x7820     0x0a18     0x00
Local Bus Adapter  10/0/8        11     8     0x7820     0x0a18     0x00
Local Bus Adapter  10/0/9        10     9     0x7820     0x0a18     0x00
Local Bus Adapter  10/0/10       9      10    0x7820     0x0a18     0x00
Local Bus Adapter  10/0/11       8      11    0x7820     0x0a18     0x00
Local Bus Adapter  10/0/12       7      12    0x7820     0x0a18     0x00
Local Bus Adapter  10/0/14       6      14    0x7820     0x0a18     0x00

PCI DEVICE INFORMATION

Description          Path          Bus   Slot   Vendor   Device
-----
Comm. serial cntlr  10/0/0/0/0   0     0     0x103c   0x1048
Ethernet cntlr     10/0/0/1/0   0     0     0x1011   0x0019
SCSI bus cntlr     10/0/6/0/0   48    5     0x1000   0x000f

Information Menu: Enter command >
    
```

HP-UX

This procedure (`parstatus -I` or `rad -q` commands) lists *complex-wide I/O* chassis details or *local partition* PCI slot details from HP-UX running on a partition.

Step 1. Log in to HP-UX running on one of the server's partitions.

To list PCI slot details, you must log in to the partition whose PCI slots you want to list.

To list I/O chassis details, you can log in to HP-UX on any partition.

Step 2. Issue the `parstatus -I` command (for complex-wide I/O chassis info) or the `rad -q` command (for the local partition's PCI slot info).

Checking I/O Expansion Cabinet Status

```
# parstatus -I
[Chassis]
```

Hardware Location	Usage	Core IO	Connected To	Par Num
cab0,bay0,chassis0	absent	-	-	-
cab0,bay0,chassis1	absent	-	-	-
cab0,bay0,chassis2	absent	-	-	-
cab0,bay0,chassis3	inactive	yes	cab0,cell4	0
cab0,bay1,chassis0	absent	-	-	-
cab0,bay1,chassis1	absent	-	-	-
cab0,bay1,chassis2	absent	-	-	-
cab0,bay1,chassis3	active	yes	cab0,cell10	0
cab1,bay0,chassis0	absent	-	-	-
cab1,bay0,chassis1	inactive	-	-	-
cab1,bay0,chassis2	absent	-	-	-
cab1,bay0,chassis3	absent	-	-	-
cab1,bay1,chassis0	absent	-	-	-
cab1,bay1,chassis1	absent	-	-	-
cab1,bay1,chassis2	absent	-	-	-
cab1,bay1,chassis3	active	yes	cab1,cell2	1
cab8,bay0,chassis1	inactive	-	-	-
cab8,bay0,chassis3	active	yes	cab0,cell2	0

```
# rad -q
```

Slot	Path	Bus	Speed	Power	Occupied	Suspended	Driver(s) Capable
0-1-3-0	0/0/0	0	33	On	Yes	No	No
0-1-3-1	0/0/1/0	8	33	Off	No	N/A	N/A
0-1-3-2	0/0/2/0	16	33	Off	No	N/A	N/A
0-1-3-3	0/0/3/0	24	33	Off	No	N/A	N/A
0-1-3-4	0/0/4/0	32	33	Off	No	N/A	N/A
0-1-3-5	0/0/6/0	48	33	On	Yes	No	Yes
8-0-3-4	2/0/4/0	32	33	Off	No	N/A	N/A
8-0-3-5	2/0/6/0	48	33	Off	No	N/A	N/A
8-0-3-6	2/0/14/0	112	33	On	Yes	No	Yes
8-0-3-7	2/0/12/0	96	33	Off	No	N/A	N/A
8-0-3-8	2/0/11/0	88	33	Off	No	N/A	N/A
8-0-3-9	2/0/10/0	80	33	Off	No	N/A	N/A
8-0-3-10	2/0/9/0	72	33	Off	No	N/A	N/A
8-0-3-11	2/0/8/0	64	33	Off	No	N/A	N/A

```
#
```

Listing Cell and Partition Connections for I/O Expansion Cabinets

You can list which cells are connected to which I/O chassis—including chassis in an I/O Expansion cabinet—by using the following methods:

- “GSP” on page 165
This procedure (IO command) lists all cell-to-I/O chassis connections from the GSP Command menu.
- “BCH” on page 165
This procedure (BCH Information menu, IO command) lists I/O chassis and PCI slot information for currently active I/O chassis in the local partition.
- “HP-UX” on page 166
This procedure (parstatus -I or parstatus -C) lists cell-to-I/O chassis connections from HP-UX.

I/O Expansion cabinets are numbered 8 and 9.

GSP

This procedure (IO command) lists all cell-to-I/O chassis connections from the GSP Command menu.

Step 1. Log in to the complex’s GSP and access its Command menu.

From the GSP main menu, enter **CM** to access the Command menu.

Step 2. Issue the IO command to list all cell-to-I/O chassis connections.

The cabinet, bay, and chassis connections for cells are listed below each cell’s “X” in the output.

```
GSP:CM> IO
```

Cabinet	0	1	2	3	4	5	6	7
Slot	01234567	01234567	01234567	01234567	01234567	01234567	01234567	01234567
Cell	X.X.X.X.	X.X.X...
IO Cab	0.8.0...	8.1.....
IO Bay	1.0.0...	1.1.....
IO Chas	3.3.3...	1.3.....

```
GSP:CM>
```

BCH

This procedure (BCH Information menu, IO command) lists I/O chassis and PCI slot information for *currently active* I/O chassis in the *local* partition.

Step 1. Access the BCH interface for the partition whose IO details you want, and access the Information menu.

Step 2. Enter the IO command from the BCH Information menu.

The IO command lists which I/O chassis are connected to which *active* cells in the *local* partition, and for each chassis it lists the PCI slots and any devices attached to the slots.

Checking I/O Expansion Cabinet Status

HP-UX

This procedure (`parstatus -I` or `parstatus -C`) lists cell-to-I/O chassis connections from HP-UX.

Step 1. Log in to HP-UX running on any of the server's partitions.

To list cell-to-I/O chassis connections you can log in to HP-UX on any partition.

Step 2. Issue the `parstatus -I` command or the `parstatus -C` command.

A System Specifications

Dimensions and Weights

This section provides dimensions and weights of the IOX.

Cabinet Dimensions

Cabinet heights are measured in meters, inches, EIA units, and “U.” One U equals 44.45 mm (1.75 in).

Table A-1 Physical Specifications for Packaged IOX Cabinet

Cabinet Size	Height	Width	Depth
1.6m (E33)	1.84 m (72.5 in)	1.016 m (40 in)	1.22 m (48 in)
1.96m (E41)	2.2 m (86.5 in)	1.016 m (40 in)	1.22 m (48 in)

Table A-2 Physical Specifications for Unpacked IOX Cabinet

Cabinet Size	Height	Width	Depth
1.6m (E33)	1.61 m (63.5 in)	59.7 cm (23.5 in)	92.7 cm (36.5 in)
1.96m (E41)	1.97 m – 41U	59.7 cm (23.5 in)	92.7 cm (36.5 in)

ICE Dimensions and Weight

When installed in the cabinet, the ICE consumes 9U of rack space. The ICE chassis external dimensions (excluding cosmetic panels and mounting flanges) are 394 mm (15.51 in) high X 448 mm (17.64 in) wide X 948 (37.3 in) mm deep.

Figure A-1 ICE Dimensions

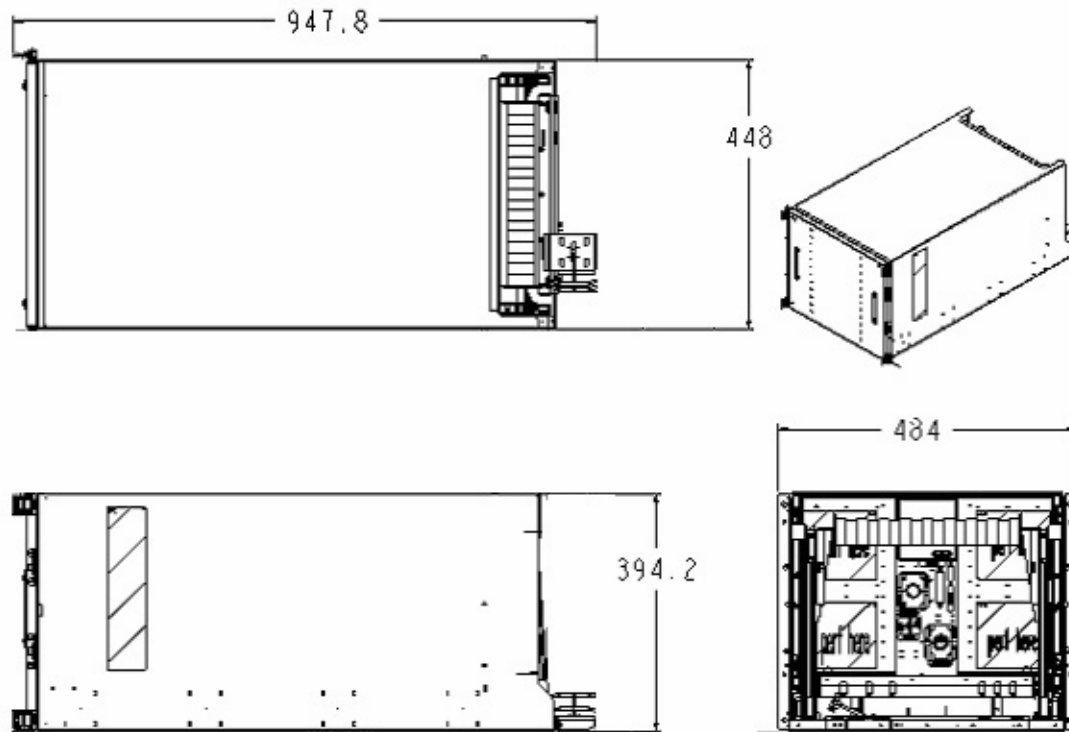

The approximate total weight of a single ICE without PCI chassis is 47.2 (104.5 lb). Each PCI chassis is approximately 22.2 kg (49 lbs).

XUC Dimension and Weight

When installed in the cabinet, the XUC consumes 3U of vertical rack space. The XUC chassis external dimensions (excluding cosmetic panels and mounting flanges) are 133.35mm (5.25 in.) high X 447.5 mm (17.6 in) wide X 414 (16.3 in) mm deep.

Figure A-2 XUC Dimensions

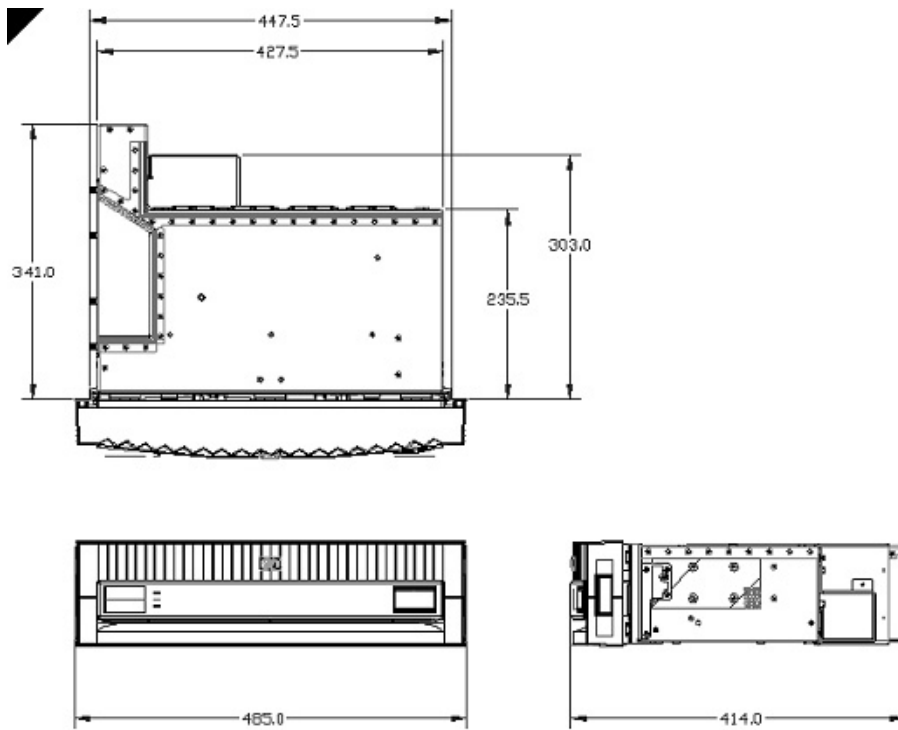

The total mass of the XUC is 12.15 kg (26.78 lb).

XPC

When installed in the cabinet, the XUC consumes 3U of vertical rack space. The XUC chassis external dimensions (excluding cosmetic panels and mounting flanges) are 124.5 mm (4.9 in.) high X 444.5 mm (17.5 in) wide X 609.6 (24 in) mm deep.

Figure A-3 XPC Dimensions

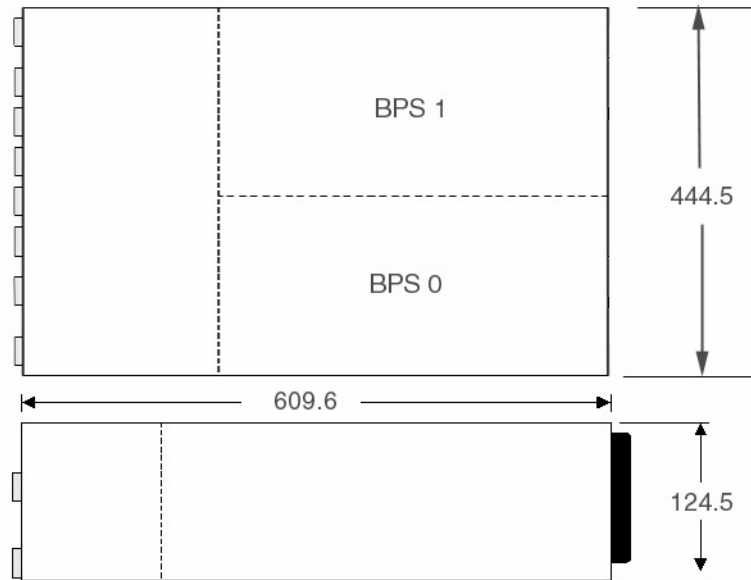

IOX Cabinet Weight

Table A-3 and Table A-4 give the total weight of 1.6m and 1.96m IOX cabinets, respectively. Please notice that the RBII-D rear anti-tip foot is included in these calculations. Additional equipment installed in an IOX, such as peripherals, is not included in these tables and will increase the mass of a given cabinet configuration.

Table A-3 1.6-meter IOX Cabinet Weights

Component	Weight (kg)	Weight (lb.)	Qty	1-ICE Subtotal (lb.)	Qty	2-ICE Subtotal (lb.)	Qty	3-ICE Subtotal (lb.)
RBII-D Front Anti-tip foot	9	19.8	1	19.8	1	19.8	1	19.8
RBII-D Rear Anti-tip foot	9	19.8	1	19.8	1	19.8	1	19.8
1.6m RBII-D Rack w/IOX Ext Sheet Metal	91.7	202.1	1	202.1	1	202.1	1	202.1
8U RBII Side Panel	0.7	1.5	3	4.6	3	4.6	3	4.6
9U RBII Side Panel	0.78	1.7	1	1.7	1	1.7	1	1.7
ICE Module	47.3	104.2	1	104.2	2	208.3	3	312.5
ICE Control Cable	0.25	0.6	1	0.6	2	1.1	3	1.7
ICE Fan Control Cable	0.2	0.4	1	0.4	2	0.9	3	1.3

Table A-3 1.6-meter IOX Cabinet Weights

Component	Weight (kg)	Weight (lb.)	Qty	1-ICE Subtotal (lb.)	Qty	2-ICE Subtotal (lb.)	Qty	3-ICE Subtotal (lb.)
ICE DC Pwr Input Cable	0.25	0.6	1	0.6	2	1.1	3	1.7
Shielded REO Cable	2.32	5.1	2	10.2	4	20.5	6	30.7
ICE Bezel	1.34	3.0	1	3.0	2	5.9	3	8.9
12-slot I/O chassis	12.3	27.1	2	54.2	4	108.4	6	162.7
Core I/O Board	0.22	0.5	2	1.0	4	1.9	6	2.9
PCI Card (max)	0.1	0.2	22	4.8	44	9.7	66	14.5
PCI Cable	0.23	0.5	36	18.2	72	36.5	108	54.7
XPC Mounting Bracket	17.4	38.3	1	38.3	1	38.3	1	38.3
XPC Control Cable	0.25	0.6	1	0.6	1	0.6	1	0.6
BPS	13.2	29.0	1	29.0	1	29.0	1	29.0
N+1BPS	13.2	29.0	1	29.0	1	29.0	1	29.0
XPC Bezel	0.62	1.4	1	1.4	1	1.4	1	1.4
AC Pwr Input Cable	0.25	0.6	1	0.6	1	0.6	1	0.6
N+1 AC Pwr Input Cable	0.25	0.6	1	0.6	1	0.6	1	0.6
XUC (w/UGUY & SBCHL)	12.15	26.8	1	26.8	1	26.8	1	26.8
XUC Bezel	0.45	1.0	1	1.0	1	1.0	1	1.0
Shielded Clock Cable	0.73	1.6	1	1.6	1	1.6	2	3.2
Shielded GSP Bus Cable	0.41	0.9	1	0.9	1	0.9	1	0.9
XUC DC Pwr Cable	0.25	0.6	1	0.6	1	0.6	1	0.6
RDM	0.35	0.77	1	0.8	1	0.8	1	0.8
XUC to RDM Cable	0.25	0.55	1	0.6	1	0.6	1	0.6
TOTAL 1.6m IOX MASS				576.8		773.9		972.7
EQUIPMENT MASS				328.6		525.8		724.6

Table A-4 1.9-meter IOX Cabinet Weights

Component	Weight (kg)	Weight (lb.)	Qty	1-ICE Subtotal (lb.)	Qty	2-ICE Subtotal (lb.)	Qty	3-ICE Subtotal (lb.)
RBII-D Front Anti-tip foot	9	19.8	1	19.8	1	19.8	1	19.8
RBII-D Rear Anti-tip foot	9	19.8	1	19.8	1	19.8	1	19.8
1.96m RBII-D Rack w/IOX Ext Sheet Metal	96.7	213.1	1	213.1	1	213.1	1	213.1
8U RBII Side Panel	0.7	1.5	4	6.2	4	6.2	4	6.2
9U RBII Side Panel	0.78	1.7	1	1.7	1	1.7	1	1.7
ICE Module	47.3	104.2	1	104.2	2	208.3	3	312.5
ICE Control Cable	0.25	0.6	1	0.6	2	1.1	3	1.7
ICE Fan Control Cable	0.2	0.4	1	0.4	2	0.9	3	1.3
ICE DC Pwr Input Cable	0.25	0.6	1	0.6	2	1.1	3	1.7
Shielded REO Cable	2.32	5.1	2	10.2	4	20.5	6	30.7
ICE Bezel	1.34	3.0	1	3.0	2	5.9	3	8.9
12-slot I/O chassis	12.3	27.1	2	54.2	4	108.4	6	162.7
Core I/O Board	0.22	0.5	2	1.0	4	1.9	6	2.9
PCI Card (max)	0.1	0.2	22	4.8	44	9.7	66	14.5
PCI Cable	0.23	0.5	36	18.2	72	36.5	108	54.7
XPC and Mounting Bracket	17.4	38.3	1	38.3	1	38.3	1	38.3
XPC Control Cable	0.25	0.6	1	0.6	1	0.6	1	0.6
BPS	13.2	29.0	1	29.0	1	29.0	1	29.0
N+1BPS	13.2	29.0	1	29.0	1	29.0	1	29.0
XPC Bezel	0.62	1.4	1	1.4	1	1.4	1	1.4
AC Pwr Input Cable	0.25	0.6	1	0.6	1	0.6	1	0.6
N+1 AC Pwr Input Cable	0.25	0.6	1	0.6	1	0.6	1	0.6
XUC (w/UGUY & SBCHL)	12.15	26.8	1	26.8	1	26.8	1	26.8
XUC Bezel	0.45	1.0	1	1.0	1	1.0	1	1.0

Table A-4 1.9-meter IOX Cabinet Weights

Component	Weight (kg)	Weight (lb.)	Qty	1-ICE Subtotal (lb.)	Qty	2-ICE Subtotal (lb.)	Qty	3-ICE Subtotal (lb.)
Shielded Clock Cable	0.73	1.6	1	1.6	1	1.6	2	3.2
Shielded GSP Bus Cable	0.41	0.9	1	0.9	1	0.9	1	0.9
XUC DC Pwr Cable	0.25	0.6	1	0.6	1	0.6	1	0.6
RDM	0.35	0.77	1	0.8	1	0.8	1	0.8
XUC to RDM Cable	0.25	0.55	1	0.6	1	0.6	1	0.6
TOTAL 1.96m IOX MASS				589.3		786.5		985.3
EQUIPMENT MASS				328.6		525.8		724.6

Electrical Specifications

This section provides electrical specifications for the IOX cabinet.

AC Power Requirements

The operating input voltage range is 176-264 VAC rms at line frequencies of 47-63 Hz. The XPC accepts one or two single phase inputs. The nominal input voltage range is 200-240 VAC rms.

Table A-5 lists the AC power requirements for a IOX cabinet. This table provides information to help you determine the amount of AC power needed for your computer room.

Table A-5 AC Input and Output Requirements

Requirement	Value or Range	Conditions or Comments
Nominal Input Voltage (VAC rms)	200 to 240	
Input Voltage Range (VAC rms)	176-264	
Frequency Range (Hz)	47-63	
Maximum Inrush AC Current (A Peak)	30A Maximum	Total for two slots populated.
Maximum Input Current Per BPS (A rms)	20A @200 vac 24A @176 vac	
Number of Phases	1	One phase per power AC input.
Ground Leakage Current	less than 3.5 mA	

For redundant AC operation (n+1=2) utilizing two input power grids, one single phase is received from power grid no. 0 and one single phase from power grid no. 1. Note the input power grids are not required to be equal in voltage or equal in phase angle.

XPC

The XPC accepts one or two AC inputs as shown in Figure A-4

Figure A-4 AC Connections on XPC

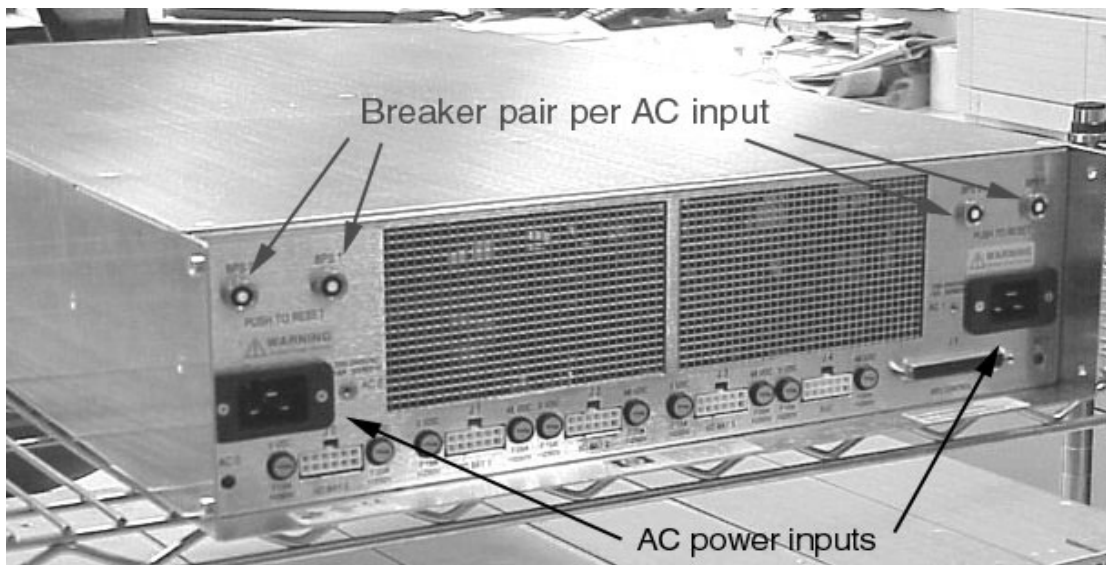

DC Power Requirements

Each BPS is capable of 48VDC at 2800W and 5.3VDC at 65W. The 48-volt supply is referred to as PS1 and 5.3-volt supply is referred to as PS2 or 5VHK. The BPSs uses an internal schottky diode in each output in order to isolate a failed output from the XPC output voltage bus.

Table A-6 BPS DC Output Specifications

Requirement	PS1	PS2/5VHK	Comments / Conditions
Output Voltage Setting (nominal VDC)	48.0 +/- 0.1	5.3 +/- 0.05	
Output Current-ADC min.	0	0	
Output Current-ADC nominal	58.4	12.3	
Output Power (watts rms min.)	2800	65	Continuous duty, with fan inlet air temperature at +35 °C.
Remote On/Off	Yes	No	PS1 is enabled by control signal PS_CTL_L
Active Current Sharing Differential (% of full load maximum)	+/-8	+/-8	Typically +/- 5% for PS1 and PS2. Using either Forced or Output Slope method.
Remote Sensing	Yes	Yes	
Remote Sense Voltage Drop (VDC Maximum)	0.5	0.15	

Environmental Requirements

This section provides the environmental, power dissipation, noise emission, and air flow specifications for the IOX cabinet.

Temperature and Humidity Specifications

Ambient intake air temperature is often different from ambient room temperature; measure the operating temperature and humidity directly in front of the cabinet cooling air intakes rather than check only ambient room conditions. Table A-7 lists the computer room temperature and humidity specifications for the IOX.

Table A-7 Temperature and Humidity Specification

Temperature and Humidity Specifications ^a		
Parameter	Recommended Operating Range	Recommended Maximum Rate of Change (per hour)
Temperature ^b	68° to 86° F (20° to 30° C)	9° F repetitive, 36° F nonrepetitive (5° C repetitive, 20° C nonrepetitive)
Humidity	15% - 80% with no condensation	6%

a. These are recommended values. For operation outside these ranges, contact your Hewlett-Packard sales representative.

b. At altitudes up to 3,000 meters.

NOTE Operating ranges refer to the ambient air temperature and humidity measured at the cabinet cooling air intake vents.

Cabinet Power Dissipation

Table A-8 lists the power dissipations of the components of the IOX cabinet.

The entry for each component lists the individual power dissipation for that component that can be installed in each cabinet.

The air conditioning data is derived from the following equations:

- Watts x (0.860) = kcal/hour
- Watts x (3.414) = Btu/hour

System Specifications
Environmental Requirements

- Btu/hour divided by 12,000 = tons of refrigeration required.

Table A-8 **Power Dissipation**

Component	Watts Dissipated
Maximum configuration IOX cabinet	3700

B Site Requirements

Careful site planning and preparation ensures trouble-free installation and reliable operation of IOXs. Factors that may contribute to less than optimal equipment operation are also highlighted.

Space Requirements

This section contains information about space requirements for a IOX cabinet. This data should be used as the basic guideline for space plan developments. Other factors, such as airflow, lighting, and equipment space requirements must also be considered.

Delivery Space Requirements

There should be enough clearance to move equipment safely from the receiving area to the computer room. Permanent obstructions, such as pillars or narrow doorways, can cause equipment damage.

Delivery plans should include the possible removal of walls or doors.

Required Foot Print and Service Access Space

The footprint of an IOX is the same as the RBII-D cabinet. The cabinet footprint dimensions, including front doors or bezels, the rear door, and RBII side skins, are 45.5 inches deep X 24.0 inches wide.

The front anti-tip foot used with the N-class adds an additional 7.0 inches of depth. Requirements for the front anti-tip foot are still undetermined. The ICE and XUC require approximately 28 inches of service area in the front of the cabinet to support extension of the chassis for service operations. Additional aisle space in front of the extended ICE will be required for personnel.

When the ICE is extended for PCI OL*, fan hot-swap and other service operations, the IOX requires side access. It should not be installed against a wall or other physical obstruction that would limit service personnel access.

Access space behind the IOX should be the same as any RBII-D cabinet. No IOX components extend toward the rear, so no additional space requirement beyond door opening clearance is anticipated.

Alignment with SuperDome Cabinet

The IOX will be installed so that the front surface of the IOX is in line with the front surface of the Half Dome, as illustrated in Figure B-1.

Figure B-1 IOX Cabinet Footprint Next to superdome Cabinet

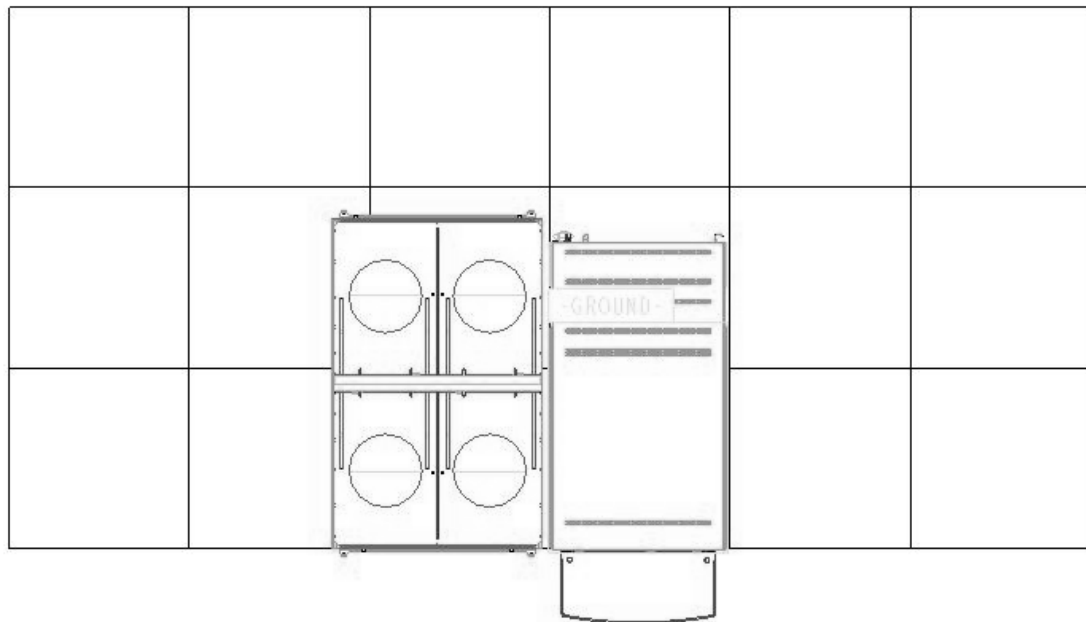

Operational Space Requirements

Other factors must be considered along with the basic equipment dimensions. Reduced airflow around equipment causes overheating, which can lead to equipment failure. Therefore, the location and orientation of air conditioning ducts, as well as airflow direction, are important. Obstructions to equipment intake or exhaust airflow must be eliminated.

The locations of lighting fixtures and utility outlets affect servicing operations. Plan equipment layout to take advantage of lighting and utility outlets. Do not forget to include clearance for opening and closing equipment doors.

Clearance around and above the cabinets must be provided for proper cooling airflow through the equipment.

If other equipment is located so that it exhausts heated air near the cooling air intakes of the computer system cabinets, larger space requirements are needed to keep ambient air intake to the computer system cabinets within the specified temperature and humidity ranges.

Space planning should also include the possible addition of equipment or other changes in space requirements. Equipment layout plans should also include provisions for the following:

- Channels or fixtures used for routing data cables and power cables
- Access to air conditioning ducts, filters, lighting, and electrical power hardware
- Power conditioning equipment
- Storage racks for tape reels, disk packs, and printer paper
- Cabinets for cleaning materials
- Maintenance area and spare parts

Power Requirements

In general, a well-designed power distribution system exceeds the requirements of most electrical codes. A good design, when coupled with proper installation practices, produces the most trouble-free operation.

A detailed discussion of power distribution system design and installation is beyond the scope of this document. However, electrical factors relating to power distribution system design and installation must be considered during the site preparation process.

The electrical factors discussed in this section are:

- Computer room safety
- Electrical load requirements (circuit breaker sizing)
- Power quality
- Distribution hardware
- System installation guidelines

Computer Room Safety

Inside the computer room, fire protection and adequate lighting (for equipment servicing) are important safety considerations. Federal and local safety codes govern computer installations.

Fire Protection

The National Fire Protection Association's Standard for the Protection of Electronic Computer Data Processing Equipment, NFPA 75, contains information on safety monitoring equipment for computer rooms.

Most computer room installations are equipped with the following fire protection devices:

- Smoke detectors
- Fire and temperature alarms
- Fire extinguishing system

Additional safety devices are:

- Circuit breakers
- An emergency power cutoff switch

Lighting Requirements for Equipment Servicing

Adequate lighting and utility outlets in a computer room reduce the possibility of accidents during equipment servicing. Safer servicing is also more efficient and, therefore, less costly.

For example, if there is not enough light, it is difficult to see cable connection points on the hardware. Adequate lighting reduces the chances of connector damage when cables are installed or removed.

The minimum recommended illumination level is 70 foot-candles (756 lumens per square meter) when the light level is measured at 30 inches (76.2 cm) above the floor.

Electrical Load Requirements (Circuit Breaker Sizing)

It is always a good idea to derate power distribution systems for one or more of the following reasons:

- To avoid nuisance tripping from load shifts or power transients, circuit protection devices should never be run above 80% of their root-mean-square (RMS) current ratings.
- Safety agencies derate most power connectors to 80% of their RMS current ratings.

Power Quality

This equipment can operate over a wide range of voltages and frequencies. It has been tested and shown to comply with EMC Specification EN50082. However, damage can occur if these ranges are exceeded. Severe electrical disturbances can exceed the design specifications of the equipment.

Sources of Electrical Disturbances

Electrical disturbances, sometimes called glitches, affect the quality of electrical power. Common sources of these disturbances are:

- Fluctuations occurring within the facility's distribution system
- Utility service low-voltage conditions (such as sags or brownouts)
- Wide and rapid variations in input voltage levels
- Wide and rapid variations in input power frequency
- Electrical storms
- Large inductive sources (such as motors)
- Faults in the distribution system wiring (such as loose connections)
- Microwave, radar, or radio transmissions

Power System Protection

Computer systems can be protected from the sources of many of these electrical disturbances by using:

- A dedicated power distribution system
- Power conditioning equipment
- Over- and under-voltage detection and protection circuits
- Screening to cancel out the effects of undesirable transmissions
- Lightning arresters on power cables to protect equipment against electrical storms

Adherence to the following guidelines provides the best possible performance of power distribution systems for IOX equipment:

- Dedicated power source—Isolates power distribution system from other circuits in the facility.
- Missing-phase and low-voltage detectors—Shuts equipment down automatically when a severe power disruption occurs. For peripheral equipment, these devices are optional but recommended.
- Uninterruptible power supply (UPS)—Keeps input voltage constant and should be considered if outages of one-half cycle or more are common. Refer to qualified contractors or consultants for each situation.

Distribution Hardware

This section describes wire selection and the types of raceways used in the distribution system.

Wire Selection

Use only copper conductors instead of aluminum, as aluminum's coefficient of expansion differs significantly from that of other metals used in power hardware. Because of this difference, aluminum conductors can cause connector hardware to work loose, overheat, and fail.

Raceway Systems

Raceways (electrical conduits) form part of the protective ground path for personnel and equipment. Raceways protect the wiring from accidental damage and also provide a heat sink for the wires.

Any of the following types may be used:

- Electrical metallic tubing (EMT) thin-wall tubing
- Rigid (metal) conduit
- Sealtight (for humid environments)

Building Distribution All building feeders and branch circuitry should be in rigid metallic conduit with proper connectors (to provide ground continuity). Conduit that is exposed and subject to damage should be constructed of rigid galvanized steel.

Raised Floor Application A cable trough is not required for the IOX installed in a computer room that has a raised floor. The power drops and interface cables from the equipment are routed down through the panel pull section, through a grommet-protected opening (beneath the floor level), and under the floor panels.

Nonraised Floor Application A cable trough may be required when the IOX is installed in a computer room that does not have a raised floor. The power drops and interface cables from system are routed down through the panel pull section, out through a grommet-protected opening, and into the cable trough.

The cable trough connects to the bottom of the power panel. It should be sized to hold all cables and receptacles for the power drops that come from the server and peripheral power panels and for the power cables and plugs that come from the peripheral cabinet(s).

While the length of the cable trough may vary from one site to the next, the width and height must be compatible with the computer system cable trough.

NOTE The cable trough should be recognized by safety agencies as a ground conductor. It should be sturdy enough to walk on.

Grounding Systems

The IOX requires two methods of grounding:

- Power distribution safety grounding
- High frequency intercabinet grounding

Power Distribution Safety Grounding

The power distribution safety grounding system consists of connecting various points in the power distribution system to earth ground using green (green/yellow) wire ground conductors. Having these ground connections tied to metal chassis parts that may be touched by computer room personnel protects them against shock hazard from current leakage and fault conditions.

Power distribution systems consist of several parts. Hewlett-Packard recommends that these parts be solidly interconnected to provide an equipotential ground to all points.

The IOX and Superdome are safety grounded through the green (ground) wire in each AC power cord. In the IOX, this ground passes through the AC power cord entry into the XPC and connects internally to the XPC chassis. The XUC chassis and each ICE chassis are grounded through their respective DC power cords from the XPC. When the power distribution safety grounds described below are correctly installed, no additional external cabinet grounds are required.

Main Building Electrical Ground The main electrical service entrance equipment should have an earth ground connection, as required by applicable codes. Connections such as a grounding rod, building steel, or a conductive type cold water service pipe provide an earth ground.

Electrical Conduit Ground All electrical conduits should be made of rigid metallic conduit that is securely connected together or bonded to panels and electrical boxes to provide a continuous grounding system.

Power Panel Ground Each power panel should be grounded to the electrical service entrance with green (green/yellow) wire ground conductors. The green (green/yellow) wire ground conductors should be sized per applicable codes (based on circuit over current device ratings).

Computer Equipment Ground Ground all computer equipment with the green (green/yellow) wire included in the branch circuitry. The green (green/yellow) wire ground conductors should be connected to the appropriate power panel and should be sized per applicable codes (based on circuit over current device ratings).

Cabinet Interconnect Grounding

High-frequency grounding between IOX and Superdome is provided by the cabinet-to-cabinet signal cabling. Additional low-frequency grounding is provided by the cabinet ground strap. See “Grounding the IOX to the Superdome” on page 58.

System Installation Guidelines

This section contains information about installation practices. Some common pitfalls are highlighted. Both power cable and data communications cable installations are discussed.

NOTE In domestic installations, the proper receptacles should be installed prior to the arrival of Hewlett-Packard equipment. Refer to the appropriate installation guide for installation procedures.

Wiring Connections

Expansion and contraction rates vary among different metals. Therefore, the integrity of an electrical connection depends on the restraining force applied. Connections that are too tight compress or deform the hardware and cause it to weaken. This usually leads to a short circuit that trips circuit breakers.

CAUTION Connections that are too loose will have a high resistance that will cause serious problems, such as erratic equipment operation. A high resistance connection overheats and sometimes causes fire or high temperatures that can destroy hard-to-replace components such as distribution panels or system bus bars.

Power Requirements

Wiring connections must be properly torqued. Many equipment manufacturers specify the proper connection torque values for their hardware.

Ground connections must only be made on a conductive, nonpainted surface. When equipment vibration is present, lockwashers must be used on all connections to prevent connection hardware from working loose.

Wiring for Power Conditioning Equipment

Power conditioning equipment sense wires must be routed well away from main power conductors and electrical devices that might produce stray coupling between circuits. Stray coupling could interfere with power conditioning sense circuits, thus nullifying their benefits.

Data Communications Cables

Route data communications cables away from areas of high energy electric fields created by power transformers and heavy foot traffic. Use shielded data communications cables that meet approved industrial standards to reduce the effects of external fields.

NOTE Hewlett-Packard supplies shielded data communications cables that comply with FCC standards for Electromagnetic Interference (EMI). Approved cables reduce the risk of high-speed data loss in serial data communications installations.

Facility Characteristics

This section contains information about facility characteristics that must be considered for the installation or operation of a IOX cabinet. Facility characteristics are:

- Floor loading
- Windows
- Altitude effects

Floor Loading

The computer room floor must be able to support the total weight of the installed computer system as well as the weight of the individual cabinets as they are moved into position.

Floor loading is usually not an issue in nonraised floor installations. The information presented in this section is directed toward raised floor installations.

NOTE Any floor system under consideration for a IOX cabinet installation should be verified by an appropriate floor system consultant.

Raised Floor Loading

Raised floor loading is a function of the manufacturer's load specification and the positioning of the equipment relative to the raised floor grid. While Hewlett-Packard cannot assume responsibility for determining the suitability of a particular raised floor system, it does provide information and illustrations for the customer or local agencies to determine installation requirements.

The following guidelines are recommended.

- Because many raised floor systems do not have grid stringers between floor stands, the lateral support for the floor stands depends on adjacent panels being in place. To avoid compromising this type of floor system while gaining under floor access, remove only one floor panel at a time.
- Larger floor grids (bigger panels) are generally rated for lighter loads.

CAUTION Do not install any raised floor system until you have carefully examined it to verify that it is adequate to support the appropriate installation.

Floor Loading Terms

Table B-1 defines floor loading terms.

Table B-1 Floor Loading Terms

Term	Definition
Dead load	The weight of the raised panel floor system, including the understructure. Expressed in lb/ft ² (kg/m ²).

Table B-1 Floor Loading Terms

Term	Definition
Live load	The load that the floor system can safely support. Expressed in lb/ft ² (kg/m ²).
Concentrated load	The load that a floor panel can support on a 1-in ² (6.45 cm ²) area at the panel's weakest point (typically the center of the panel), without the surface of the panel deflecting more than a predetermined amount.
Ultimate load	The maximum load (per floor panel) that the floor system can support without failure. Failure expressed by floor panel(s) breaking or bending. Ultimate load is usually stated as load per floor panel.
Rolling load	The load a floor panel can support (without failure) when a wheel of specified diameter and width is rolled across the panel.
Average floor load	Computed by dividing total equipment weight by the area of its footprint. This value is expressed in lb/ft ² (kg/m ²).

Average Floor Loading

The average floor load value, defined in Table B-1, is not appropriate for addressing raised floor ratings at the floor grid spacing level. However, it is useful for determining floor loading at the building level, such as the area of solid floor or span of raised floor tiles covered by the IOX cabinet footprint.

Typical Raised Floor Site

This section contains an example of a computer room raised floor system that is satisfactory for the installation of a IOX cabinet.

Based on specific information provided by Hewlett-Packard, Tate Access Floors has recommended its Series 800 all-steel access floor with bolt-together stringers and 24 in. (61.0 cm) by 24 in. (61.0 cm) floor panels.

Table B-2 lists specifications for the Tate Access Floors Series 800 raised floor system.

Table B-2 Typical Raised Floor Specifications

Item	Rating
Dead load	7 lb/ft ² (34.2 kg/m ²)
Live load	313 lb/ft ² (1528.3 kg/m ²)
Concentrated load	1250 lb (567 kg)
Ultimate load	4000 lb (1814 kg) per panel
Rolling load	400 lb (181 kg)
Rolling load	500 lb (227 kg)

Altitude Effects

Many tape drives, including those supplied by Hewlett-Packard, have vacuum column transport mechanisms that are affected by atmospheric pressure. Adjustments to these mechanisms may be required to compensate for the lower atmospheric pressure at higher altitudes. Hewlett-Packard field engineers make these adjustments on tape drives supplied by Hewlett-Packard. Tape drives supplied by other vendors should be

adjusted by the appropriate vendor.

Safety Considerations

Before proceeding with any installation, maintenance, or service on a system which requires physical contact with electrical or electronic components, be sure that either power is removed or safety precautions are followed to protect against electric shock and equipment damage. Observe all "WARNING" and "CAUTION" labels on equipment. All installation and service work must be done by qualified personnel.

Communications Interference

Hewlett-Packard system compliance tests are conducted with Hewlett-Packard supported peripheral devices and shielded cables, such as those received with the system. The system meets interference requirements of all countries in which it is sold. These requirements provide reasonable protection against interference with radio and television communications.

Installing and using the system in strict accordance with Hewlett-Packard's instructions minimizes the chances that the system will cause radio or television interference. However, Hewlett-Packard does not guarantee that the system will not interfere with radio and television reception.

Take these precautions:

- Use only shielded cables.
- Install and route the cables per the instructions provided.
- Ensure that all cable connector screws are firmly tightened.
- Use only Hewlett-Packard supported peripheral devices.
- Ensure that all panels and cover plates are in place and secure before system operation.

Electrostatic Discharge

Hewlett-Packard systems and peripherals contain assemblies and components that are sensitive to electrostatic discharge (ESD). Carefully observe the precautions and recommended procedures in this manual to prevent component damage from static electricity.

Take these precautions:

- Always wear a grounded wrist strap when working on or around the system.
- Treat all assemblies, components, and interface connections as static-sensitive.
- When unpacking cards, interfaces, and other accessories that are packaged separately from the system, keep the accessories in their conductive plastic bags until they are ready to be installed.
- Before removing or replacing any components or installing any accessories in the system, select a work area where potential static sources are minimized (preferably an anti-static work station).
- Avoid working in carpeted areas, and keep body movement to a minimum while installing accessories.

Environmental Requirements

The following environmental elements can affect an IOX installation:

- Computer room preparation
- Cooling requirements
- Humidity level
- Air conditioning ducts
- Dust and pollution control
- Electrostatic discharge (ESD) prevention
- Acoustics (noise reduction)

Computer Room Preparation

The following guidelines are recommended when preparing a computer room for a IOX system:

- Locate the computer room away from the exterior walls of the building to avoid the heat gain from windows and exterior wall surfaces.
- When exterior windows are unavoidable, use windows that are double or triple glazed and shaded to prevent direct sunlight from entering the computer room.
- Maintain the computer room at a positive pressure relative to surrounding spaces.
- Use a vapor barrier installed around the entire computer room envelope to restrain moisture migration.
- Caulk and vapor seal all pipes and cables that penetrate the envelope.
- Use a 10-inch to 12-inch raised floor system for the most favorable room air distribution system (underfloor distribution).

Cooling Requirements

Air conditioning equipment requirements and recommendations are described in the following sections.

NOTE If a power source such as a UPS is located in the computer room, include its cooling requirements with the main system complex total. If placed in a different room, its cooling requirements are separate and must be added to the appropriate room totals.

Basic Air Conditioning Equipment Requirements

The cooling capacity of the installed air conditioning equipment for the computer room should be sufficient to offset the computer equipment dissipation loads, as well as any space envelope heat gain. This equipment should include:

- Air filtration
- Cooling or dehumidification
- Humidification

Environmental Requirements

- Reheating
- Air distribution
- System controls adequate to maintain the computer room within the operating ranges listed in

Lighting and personnel must also be included. For example, a person dissipates about 450 BTUs per hour while performing a typical computer room task.

At altitudes above 10,000 feet (3048 m), the lower air density reduces the cooling capability of air conditioning systems. If your facility is located above this altitude, the recommended temperature ranges may need to be modified. For each 1000 feet (305 m) increase in altitude above 10,000 feet (up to a maximum of 15,000 feet), subtract 1.5° F (0.83° C) from the upper limit of the temperature range.

Air Conditioning System Guidelines

The following guidelines are recommended when designing an air conditioning system and selecting the necessary equipment:

- The air conditioning system that serves the computer room should be capable of operating 24 hours a day, 365 days a year. It should also be independent of other systems in the building.
- Consider the long-term value of computer system availability, redundant air conditioning equipment or capacity.
- The system should be capable of handling any future computer system expansion.
- Air conditioning equipment air filters should have a minimum rating of 45% (based on “ASHAE Standard 52-76, Dust Spot Efficiency Test”).
- Introduce only enough outside air into the system to meet building code requirements (for human occupancy) and to maintain a positive air pressure in the computer room.

Air Conditioning System Types

The following three air conditioning system types are listed in order of recommendation:

- Complete self-contained package unit(s) with remote condenser(s). These systems are available with up or down discharge and are usually located in the computer room.
- Chilled water package unit with remote chilled water plant. These systems are available with up or down discharge and are usually located in the computer room.
- Central station air handling units with remote refrigeration equipment. These systems are usually located outside the computer room.

Basic Air Distribution Systems

A basic air distribution system includes supply air and return air. In some cases, the type of air conditioning system that is used determines what type of air distribution system is appropriate.

An air distribution system should be zoned to deliver an adequate amount of supply air to the cooling air intake vents of the computer system equipment cabinets. Supply air temperature should be maintained within the following parameters:

- Ceiling supply system—From 55° F (12.8° C) to 60° F (15.6° C)
- Floor supply system—At least 60° F (15.6° C)

If a ceiling plenum return air system or a ducted ceiling return air system is used, the return air grille(s) in the ceiling should be located directly above the computer equipment cabinets.

The following three types of air distribution system are listed in order of recommendation:

- Underfloor air distribution system—Downflow air conditioning equipment located on the raised floor of the computer room uses the cavity beneath the raised floor as plenum for the supply air.

Return air from an underfloor air distribution system can be room space return air (RSRA), as shown in Figure B-2 on page 194, or ducted return air (DRA) above the ceiling, as shown in Figure B-3 on page 195.

Perforated floor panels (available from the raised floor manufacturer) should be located around the perimeter of the system cabinets. Supply air emitted through the perforated floor panels is then available near the cooling air intake vents of the computer system cabinets.

- Ceiling plenum air distribution system—Supply air is ducted into the ceiling plenum from upflow air conditioning equipment located in the computer room or from an air handling unit (remote).

The ceiling construction should resist air leakage. Place perforated ceiling panels (with down discharge air flow characteristics) around the perimeter of the system cabinets. The supply air emitted downward from the perforated ceiling panels is then available near the cooling air intake vents of the computer system cabinets.

Return air should be ducted back to the air conditioning equipment through the return air duct above the ceiling.

- Above ceiling ducted air distribution system—Supply air is ducted into a ceiling diffuser system from upflow air conditioning equipment located in the computer room or from an air handling unit (remote).

Return air from an above ceiling ducted air distribution system may be ducted return air (DRA) above the ceiling, as shown in Figure B-2 on page 194, or ceiling plenum return air (CPRA), as shown in Figure B-3 on page 195.

Adjust the supply air diffuser system grilles to direct the cooling air downward around the perimeter of the computer system cabinets. The supply air is then available near the cooling air intake vents of the computer system cabinets.

Air Conditioning System Installation

All air conditioning equipment, materials, and installation must comply with any applicable construction codes. Installation of the various components of the air conditioning system must also conform to the air conditioning equipment manufacturer's recommendations.

Figure B-2 on page 194 illustrates a typical computer room underfloor air distribution system (RSRA).

Figure B-3 on page 195 illustrates a typical computer room underfloor air distribution system (DRA).

Figure B-4 on page 196 illustrates a typical computer room ceiling plenum air distribution system (CPRA).

Figure B-5 on page 197 illustrates a typical computer room above ceiling ducted air distribution system (DRA).

Figure B-2 Abovefloor Air Distribution System

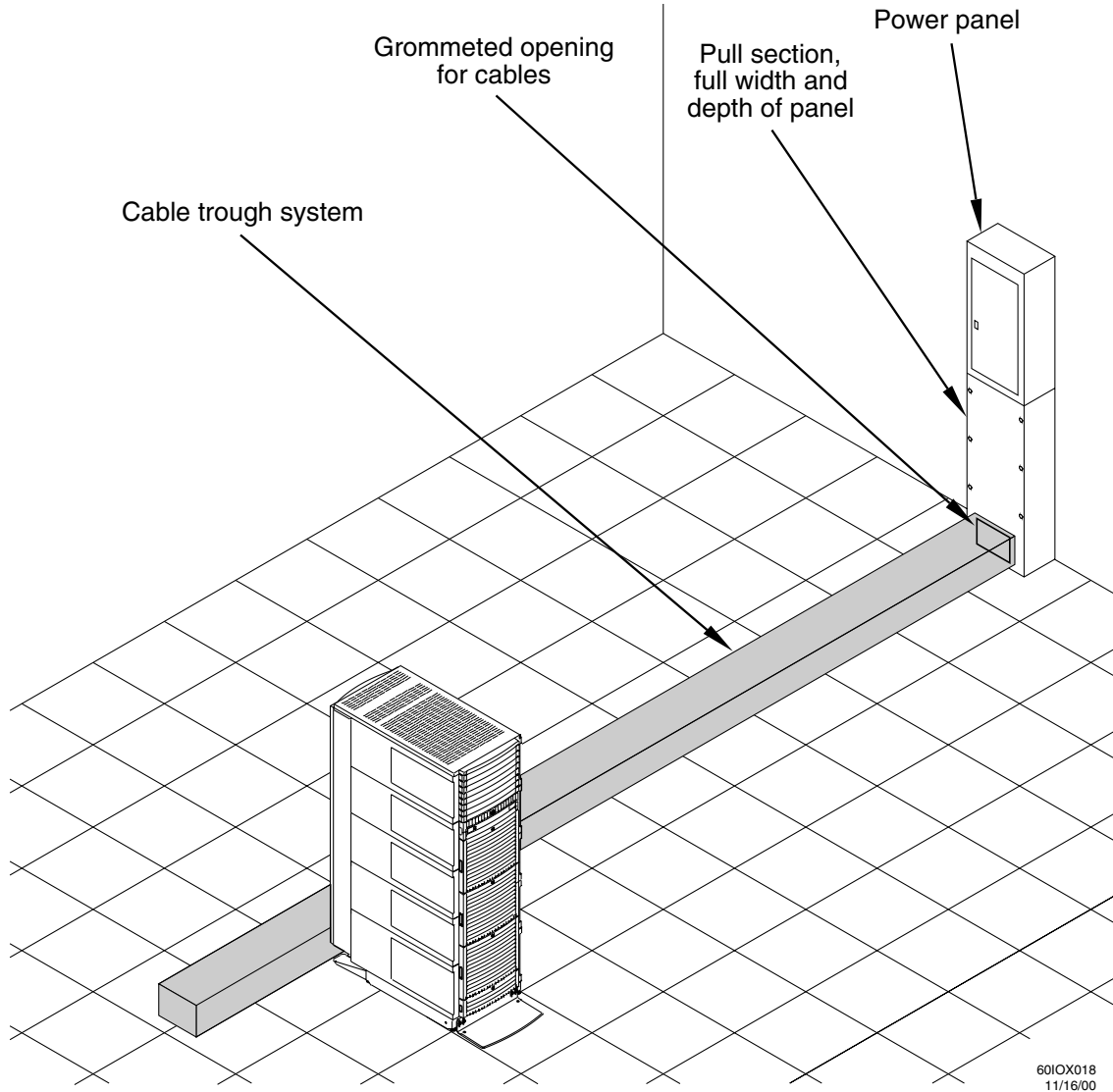

Figure B-3

Underfloor Air Distribution System

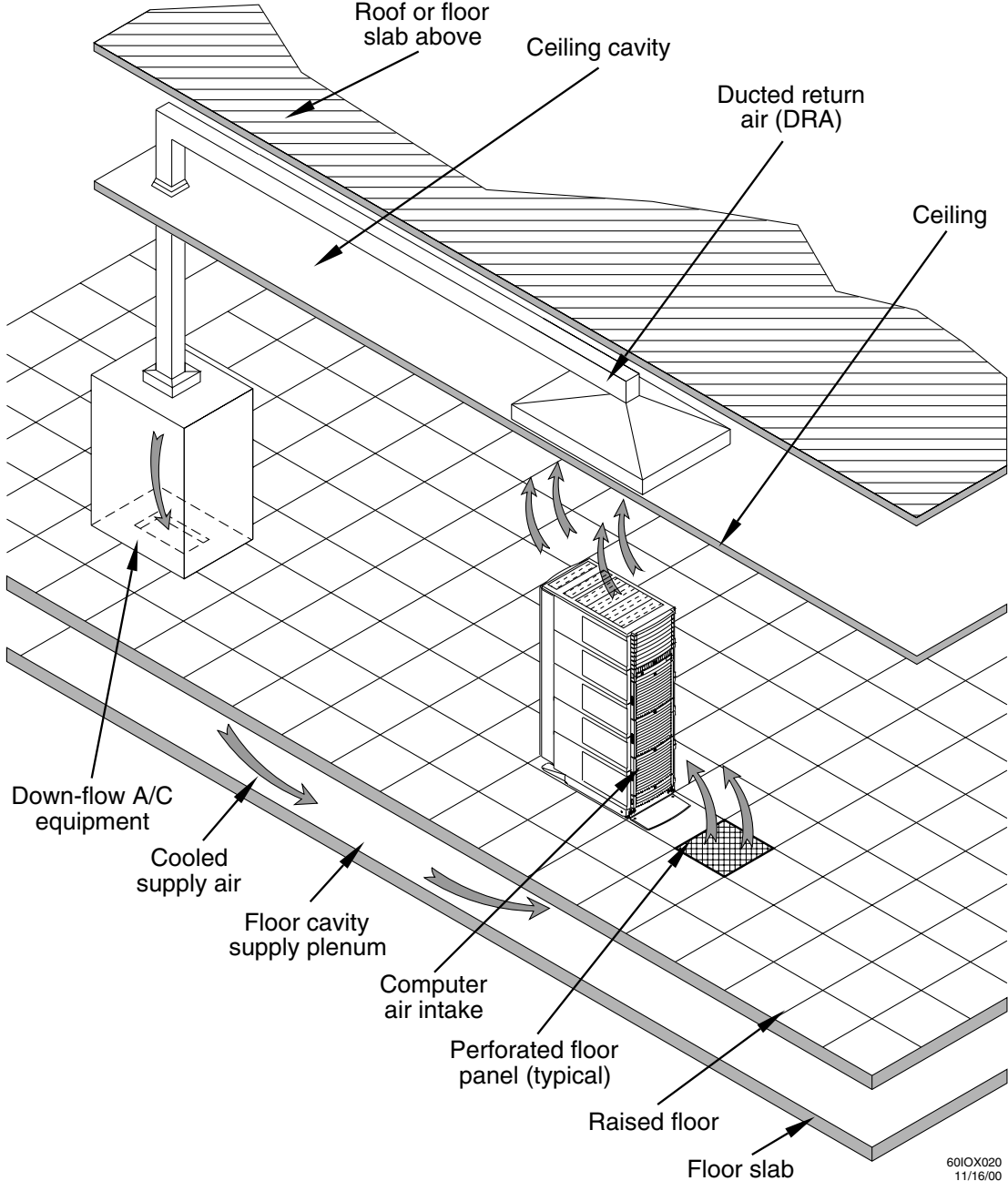
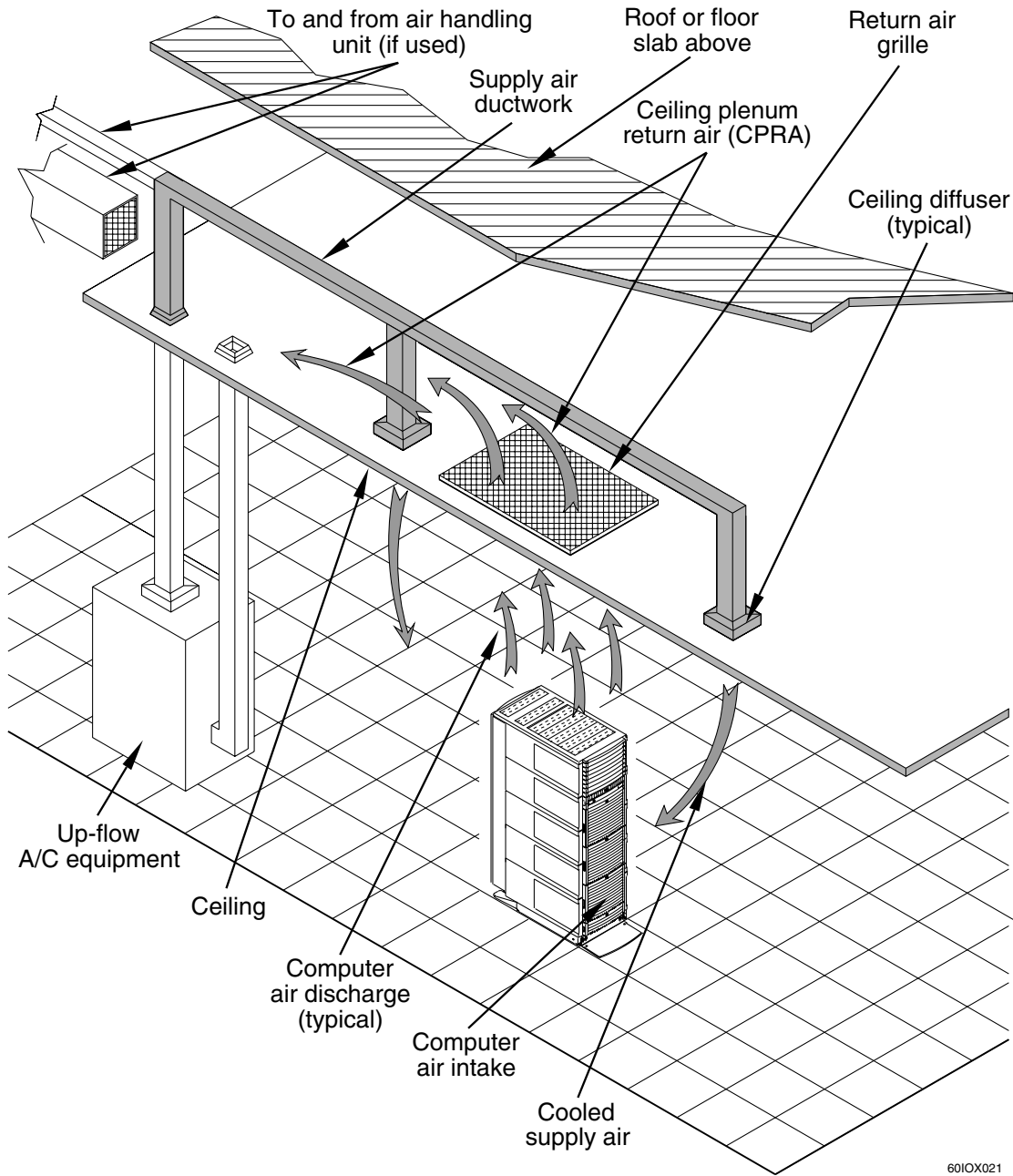
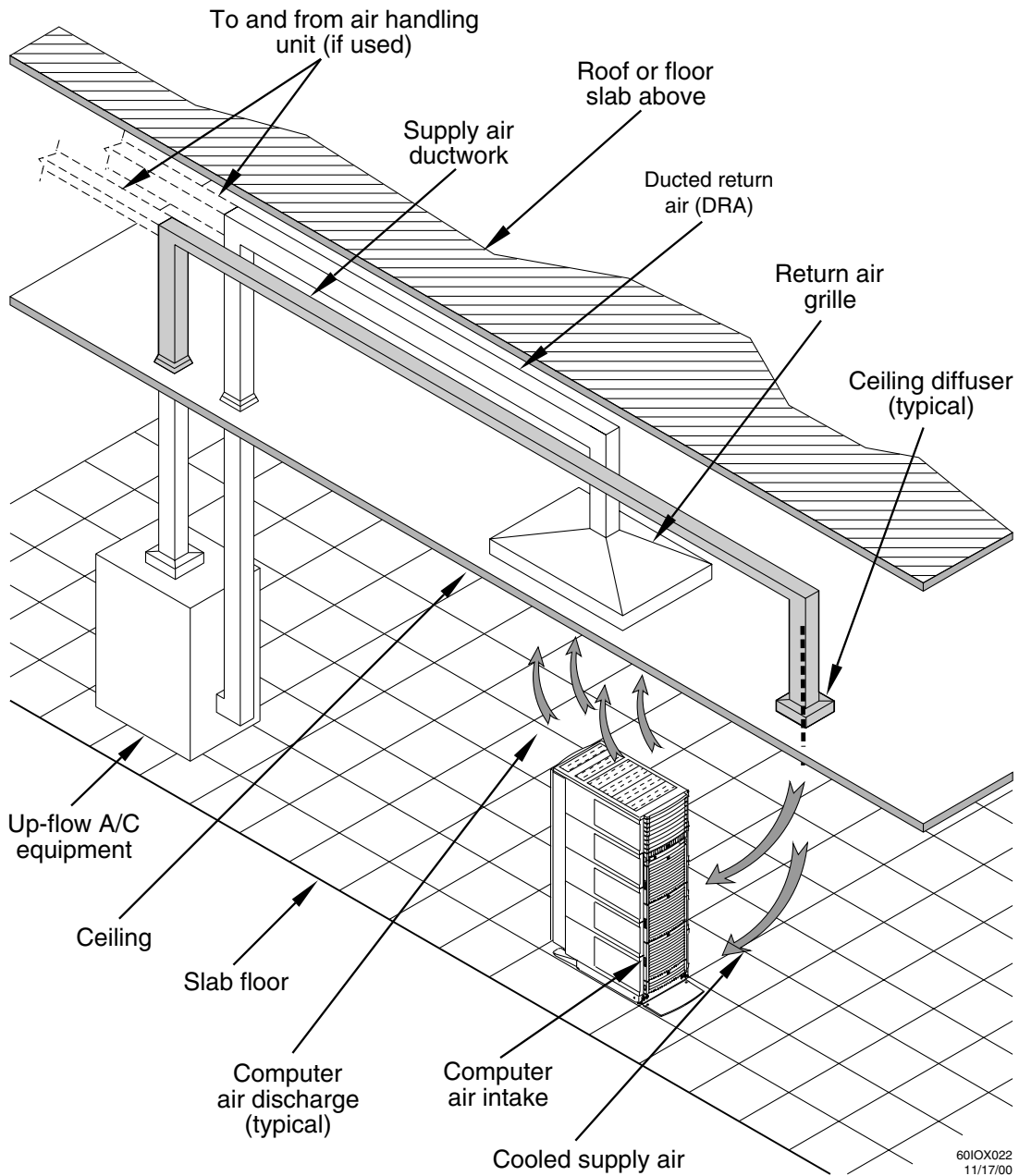

Figure B-4 Ceiling Plenum Air Distribution System



60IOX021
11/17/00

Figure B-5 Above Ceiling Ducted Air



Humidity Level

Maintain proper humidity levels. High humidity causes galvanic actions to occur between some dissimilar metals. This eventually causes a high resistance between connections, leading to equipment failures. High humidity can also have an adverse affect on some magnetic tapes and paper media.

CAUTION Low humidity contributes to undesirably high levels of electrostatic charges. This increases the electrostatic discharge (ESD) voltage potential. ESD can cause component damage during

Environmental Requirements

servicing operations. Paper feed problems on high-speed printers are usually encountered in low-humidity environments.

Low humidity levels are often the result of the facility heating system and occur during the cold season. Most heating systems provide air with a low humidity level, unless the system has a built-in humidifier.

Air Conditioning Ducts

Use separate computer room air conditioning duct work. If it is not separate from the rest of the building, it might be difficult to control cooling and air pressure levels. Duct work seals are important for maintaining a balanced air conditioning system and high static air pressure. Adequate cooling capacity means little if the direction and rate of air flow cannot be controlled because of poor duct sealing. Also, the ducts should not be exposed to warm air, or humidity levels may increase.

Dust and Pollution Control

Disk drives, tape drives, and some other mechanical devices require a dust-free environment for trouble-free operation. Hewlett-Packard disk and tape drives are protected from dust particles by mechanical air filters designed to trap large dust particles.

Smaller particles can pass through some filters and, over a period of time, cause problems in mechanical parts. Small dust particles can be prevented from entering the computer room by maintaining its air conditioning system at a high static air pressure level.

The computer room should be kept clean. The following guidelines are recommended:

- Smoking—Establish a no-smoking policy. Cigarette smoke particles are eight times larger than the clearance between disk drive read/write heads and the disk surface.
- Printer—Locate printers (especially high-speed line printers) in a separate room to eliminate paper problems.
- Eating or drinking—Establish a no-eating or drinking policy. Spilled liquids can cause short circuits in equipment such as keyboards.
- Rugs—Use a tightly sealed vacuum cleaner to clean rugs.
- Tile floors—Use a dust-absorbent cloth mop rather than a dry mop to clean tile floors.

Special precautions are necessary if the computer room is near a source of air pollution. Some air pollutants, especially hydrogen sulfide (H₂S), are not only unpleasant but corrosive as well. Hydrogen sulfide damages wiring and delicate sound equipment. The use of activated charcoal filters reduces this form of air pollution.

Electrostatic Discharge (ESD) Prevention

Static charges (voltage levels) occur when objects are separated or rubbed together. The voltage level of a static charge is determined by the following factors:

- Types of materials
- Relative humidity
- Rate of change or separation

Effect of Humidity on ESD Charge Levels

Table B-3 lists charge levels based on personnel activities and humidity levels.

Table B-3 Static Charge Levels and Relative Humidity

Personnel Activity ^a	Humidity ^b and Charge Levels (voltages) ^c			
	26%	32%	40%	50%
Person walking across a linoleum floor	6,150 V	5,750 V	4,625 V	3,700 V
Person walking across a carpeted floor	18,450 V	17,250 V	13,875 V	11,100 V
Person getting up from a plastic chair	24,600 V	23,000 V	18,500 V	14,800 V

- a. Source: B.A. Unger, *Electrostatic Discharge Failures of Semiconductor Devices* (Bell Laboratories, 1981)
- b. For the same relative humidity level, a high rate of airflow produces higher static charges than a low airflow rate.
- c. Some data in this table has been extrapolated.

Static Protection Measures

Follow these precautions to minimize possible ESD-induced failures in the computer room:

- Install conductive flooring (conductive adhesive must be used when laying tiles).
- Use conductive wax if waxed floors are necessary.
- Ensure that all equipment and flooring are properly grounded and are at the same ground potential.
- Use conductive tables and chairs.
- Use a grounded wrist strap (or other grounding method) when handling circuit boards.
- Store spare electronic modules in antistatic containers.
- Maintain recommended humidity level and airflow rates in the computer room.

Acoustics

Computer equipment and air conditioning blowers cause computer rooms to be noisy. Ambient noise level in a computer room can be reduced as follows:

- Dropped ceiling—Cover with a commercial grade of fire-resistant, acoustic rated, fiberglass ceiling tile.
- Sound deadening—Cover the walls with curtains or other sound deadening material.
- Removable partitions—Use foam rubber models for most effectiveness.

C Terms and Acronyms

Table C-1 lists some terms and acronyms used in this document.

Table C-1 Terms and Acronyms

Term or Acronym	Definition	Notes
BPS	Bulk Power Supply	
Cabinet		RBII-D rack in which I/O Expansion components are installed
Chassis		Sheet metal enclosure components
EMC	Electromagnetic Compatibility	
EMI	Electromagnetic Interference	
FRU	Field Replaceable Unit	
GSP Bus	Guardian Service Processor	Connection between Half Dome and IOX cabinets. The GSP Bus cable was formerly known as the USBc cable
Hot Swap		To replace a failed component while the system is operational
ICE	I/O Chassis Enclosure	Mechanical support and electrical interconnect structure for two 12-slot I/O chassis
IOX	Half Dome I/O Expansion Cabinet	I/O expansion system for Half Dome. Consists of RBII-D rack, utility and power modules, and up to 3 ICE modules
PCA	Printed Circuit Assembly	
RBII-D	Rosebowl II Rack with depth extension	Rack System/E or HP's latest generation 19 inch equipment rack with sheet metal depth extension developed for N-Class. Conforms to Electronic Industries Association (EIA) standard 310-D, type A. RBII-D racks are available in 25U, 33U and 41U heights.
RDM	I/O Expansion Rear Display Module	IOX component providing rear panel information
SBCHL	Single Board Computer Hub Lite	
U	Modular Unit Height	EIA310-D standard height for vertical rack space. One "U" is equal to 44.45mm (1.75 in.).
UGUY	Utilities Board	
XFanB	I/O Expansion Fan Board	
XFPB	I/O Expansion Front Panel Board	

Table C-1 **Terms and Acronyms**

Term or Acronym	Definition	Notes
XPC	I/O Expansion Power Chassis	IOX component providing DC power for IOX components

A

altitude effects, 188
average floor loading, 188

C

cable groomer, 79
cable groomer kick plate, 79
cables
 routing, 79

D

delivery space requirements, 180

F

facility characteristics, 187
facility guidelines
 altitude effects, 188
 average floor loading, 188
 characteristics, 187
 delivery space requirements, 180
 floor loading, 187
 floor loading terms, 187
 operational space requirements, 181
 raised floor loading, 187
 space requirements, 180
 typical raised floor site, 188
floor loading, 187
 average, 188
 raised floor, 187
 terms, 187

R

raised floor loading, 187
routing cables, 79

S

space requirements, 180
 delivery space requirements, 180
 operational, 181

T

typical raised floor site, 188

V

V 6000 system
 delivery space requirements, 180
 space requirements, 180