

HP Data Protector A.06.10

Installation and licensing guide

[Build 500]



T B D

Part number: TBD
First edition: TBD Month 2008



i n v e n t

Legal and notice information

© Copyright 1999, 2008 Hewlett-Packard Development Company, L.P.

Confidential computer software. Valid license from HP required for possession, use or copying. Consistent with FAR 12.211 and 12.212, Commercial Computer Software, Computer Software Documentation, and Technical Data for Commercial Items are licensed to the U.S. Government under vendor's standard commercial license.

The information contained herein is subject to change without notice. The only warranties for HP products and services are set forth in the express warranty statements accompanying such products and services. Nothing herein should be construed as constituting an additional warranty. HP shall not be liable for technical or editorial errors or omissions contained herein.

Intel, Itanium, Pentium, Intel Inside, and the Intel Inside logo are trademarks or registered trademarks of Intel Corporation or its subsidiaries in the United States and other countries.

Microsoft, Windows, Windows XP, and Windows NT are U.S. registered trademarks of Microsoft Corporation.

Adobe and Acrobat are trademarks of Adobe Systems Incorporated.

Java is a US trademark of Sun Microsystems, Inc.

Oracle is a registered US trademark of Oracle Corporation, Redwood City, California.

UNIX is a registered trademark of The Open Group.

Printed in the US

Contents

Publication history	17
About this guide	19
Intended audience	19
Documentation set	19
Guides	19
Online help	22
Documentation map	23
Abbreviations	23
Map	24
Integrations	25
Document conventions and symbols	26
Data Protector graphical user interface	27
General Information	28
HP technical support	28
Subscription service	29
HP websites	29
Documentation feedback	29
1 Overview of the installation procedure	31
In this chapter	31
Overview of the installation procedure	31
The remote installation concept	34
Data Protector installation DVD-ROMs	35
Choosing the Cell Manager system	37
Choosing the Data Protector user interface system	38
The Data Protector graphical user interface	39
2 Installing Data Protector on your network	41
In this chapter	41
Installing the Data Protector Cell Manager (CM) and Installation Server(s) (IS)	42
Installing a UNIX Cell Manager	43
Setting kernel parameters	45

Installation procedure	45
The installed directory structure on HP-UX, Solaris, and Linux	48
Configuring automatic startup and shutdown	49
Setting environment variables	51
Allocating more disk space for the Cell Manager installation	52
What's next?	52
Installing a Windows Cell Manager	52
Installation procedure	54
After the installation	58
Troubleshooting	60
What's next?	60
Installing Installation Servers	61
Installing Installation Servers for UNIX	61
Installing an Installation Server for Windows	65
Installing Data Protector clients	69
Data Protector components	72
Remote installation of Data Protector clients	77
Remote installation using secure shell	83
Installing Windows clients	86
Local installation	88
Connecting a backup device to Windows systems	91
Installing HP-UX clients	93
Checking the kernel configuration on HP-UX	94
Connecting a backup device to HP-UX systems	96
Installing Solaris clients	96
Post-installation configuration	98
Connecting a backup device to a Solaris system	102
Installing Linux clients	103
Connecting a backup device to the Linux system	108
Installing AIX clients	109
Connecting a backup device to an AIX client	111
Installing Siemens Sinix clients	112
Connecting a backup device to Siemens Sinix system	112
Installing Tru64 clients	114
Connecting a backup device to Tru64 client	115
Installing SCO clients	116
Connecting a backup device to an SCO system	117
Installing a Media Agent to use the ADIC/GRAU Library or the StorageTek Library	118
Connecting library drives	119
Preparing Data Protector clients to use the ADIC/GRAU Library	119
Installing a Media Agent to use the ADIC/GRAU Library	121
Preparing Data Protector clients to use the StorageTek Library	125

Installing a Media Agent to use the StorageTek Library	126
Local installation of the Novell NetWare clients	128
Local installation of OpenVMS clients	135
Installing MPE/iX clients	142
Local installation of UNIX clients	146
Installing the Data Protector integration clients	151
Local installation	153
Remote installation	153
Installing cluster-aware integrations	154
Microsoft Exchange Server clients	154
Microsoft SQL Server clients	155
Microsoft SharePoint Portal Server Clients	155
Sybase clients	155
Informix Server clients	155
SAP R/3 clients	156
SAP DB clients	156
Oracle clients	157
VMware Virtual Infrastructure clients	157
DB2 clients	158
NNM clients	158
NDMP clients	158
Microsoft Volume Shadow Copy Service clients	159
Lotus Notes/Domino Server clients	159
EMC Symmetrix integration	159
EMC Symmetrix Integration with Oracle	160
EMC Symmetrix Integration with SAP R/3	161
EMC Symmetrix Integration with Microsoft SQL Server	164
HP StorageWorks Disk Array XP integration	164
HP StorageWorks Disk Array XP integration with Oracle	165
HP StorageWorks Disk Array XP integration with SAP R/3	166
HP StorageWorks Disk Array XP integration with Microsoft Exchange Server	169
HP StorageWorks Disk Array XP integration with Microsoft SQL Server	170
HP StorageWorks Virtual Array integration	170
HP StorageWorks VA integration with Oracle	171
HP StorageWorks VA integration with SAP R/3	172
HP StorageWorks VA integration with Microsoft Exchange Server	175
HP StorageWorks VA integration with Microsoft SQL Server	176
HP StorageWorks Enterprise Virtual Array integration	176
HP StorageWorks EVA integration with Oracle	177
HP StorageWorks EVA integration with SAP R/3	178
HP StorageWorks EVA integration with Microsoft Exchange Server	181
HP StorageWorks EVA integration with MS SQL	182

Installing the Data Protector IAP components	182
Installing the Data Protector VLS automigration components	183
Installing localized Data Protector user interface	184
Installing localized Data Protector user interface on Windows systems	184
Installing localized Data Protector user interface on UNIX systems	186
Troubleshooting	187
Installing the Data Protector Single Server Edition	187
Limitations of SSE for Windows	188
Limitations of SSE for HP-UX and Solaris	188
Installing Data Protector web reporting	189
Installing Data Protector on MC/ServiceGuard	190
Installing a cluster-aware Cell Manager	190
Installing a cluster-aware client	191
Installing Data Protector on Microsoft Cluster Server	191
Installing a cluster-aware Cell Manager	191
Installing cluster-aware clients	199
Installing Data Protector clients on a Veritas Cluster	202
Installing a Client	202
Installing Data Protector clients on a Novell NetWare Cluster	203
Installing a client	203

3 Maintaining the installation 207

In this chapter	207
Importing clients to a cell	207
Importing an installation server to a cell	210
Importing a cluster-aware client to a cell	210
Microsoft Cluster Server	211
Other clusters	212
Exporting clients from a cell	213
Security considerations	216
Security layers	216
Client security	216
Data Protector users	217
Cell Manager security	218
Other security aspects	218
Securing clients	219
The allow_hosts and deny_hosts files	224
Excessive logging to the inet.log file	224
Strict hostname checking	225
Enabling the feature	227
Start backup specification user right	227
Hiding the contents of backup specifications	227

Host trusts	228
Monitoring security events	229
Verifying which Data Protector patches are installed	229
Verifying Data Protector patches using the GUI	230
Verifying Data Protector Patches Using the CLI	231
Uninstalling Data Protector software	231
Uninstalling a Data Protector client	232
Uninstalling the Cell Manager and Installation Server	233
Uninstalling from Windows system	234
Uninstalling from HP-UX system	236
Uninstalling the Cell Manager and/or Installation Server configured on MC/ServiceGuard	236
Uninstalling from Solaris systems	239
Uninstalling from Linux systems	241
Manual removal of Data Protector software on UNIX	243
Changing Data Protector software components	245

4 Upgrading to Data Protector A.06.10 249

In this chapter	249
Upgrade overview	249
Upgrade sequence	250
The need to convert file names in the IDB	251
Automigration of encryption keys	252
Upgrading from Data Protector A.05.10, A.05.50, and A.06.00	252
Upgrading the UNIX Cell Manager and Installation Server	253
Upgrading a Cell Manager	253
Upgrading an Installation Server	256
Upgrading the Windows Cell Manager and Installation Server	259
Checking configuration changes	264
Upgrading the clients	266
Upgrading the Oracle integration	268
Upgrading the SAP R/3 integration	270
Upgrading the Informix server integration on UNIX systems	271
Upgrading the Informix server integration on Windows systems	272
Upgrading the Sybase integration on UNIX systems	274
Upgrading the Sybase integration on Windows systems	275
Upgrading the HP StorageWorks EVA integration	276
Upgrading other integrations	278
Upgrading in a MoM environment	278
Conversion of file names in the IDB	279
IDB conversion on a Windows Cell Manager	283
IDB conversion on a UNIX Cell Manager	285

Upgrading from the Single Server Edition	286
Upgrading from earlier versions of SSE to Data Protector A.06.10 SSE	286
Upgrading from Data Protector A.06.10 SSE to Data Protector A.06.10	286
Upgrading the Cell Manager	287
Upgrading from multiple installations	287
Upgrading from HP StorageWorks Application Recovery Manager A.06.00	288
Internal database backup after the upgrade	289
Upgrade of backup specifications	289
Changes in omnib usage	289
Upgrading from Windows NT to newer version of Windows	289
Upgrading from Solaris 8 to Solaris 9	290
Migrating from HP-UX 11.x (PA-RISC) to HP-UX 11.23/11.31 (IA-64)	290
MoM specifics	294
Installation Server specifics	295
Migrating from 32-bit/64-bit Windows to 64-bit Windows/Windows Server 2008	295
MoM specifics	299
Installation Server specifics	299
Upgrading the Cell Manager configured on MC/ServiceGuard	300
Upgrading the Cell Manager configured on Microsoft Cluster Server	304

5 Data Protector licensing 309

In this chapter	309
Introduction	309
License checking and reporting	309
Cell Manager related licenses	310
Entity based licenses	310
Capacity based licenses	311
Used capacity calculation	312
The advanced backup to disk license	313
Capacity based licensing examples	315
Producing a license report on demand	319
Which licenses are available?	320
Password considerations	321
Data Protector passwords	322
Obtaining and installing permanent passwords using the HP AutoPass utility ...	323
Other ways of obtaining and installing permanent passwords	326
Verifying the password	329
Finding the number of installed licenses	329
Moving licenses to another Cell Manager System	330
Centralized licensing	331
The Data Protector order tool	331

6 Troubleshooting installation	333
In this chapter	333
Name resolution problems when installing the Windows Cell Manager	333
Verifying DNS connections within Data Protector cell	334
Using the omnichck command	335
Troubleshooting installation and upgrade of Data Protector	337
Problems with remote installation of Windows clients	338
Troubleshooting installation of the Data Protector Cell Manager on Solaris	339
Troubleshooting installation of UNIX clients	341
Troubleshooting installation of Windows XP clients	341
Verifying Data Protector client installation	341
Troubleshooting upgrade	342
Manual upgrade procedure	343
Using log files	343
Local installation	343
Remote installation	344
Data Protector log files	344
Creating installation execution traces	345
A Appendix A	347
Data Protector A.06.10 product structure and licenses	347
Starter Packs	348
Media	349
Manuals	349
Drive and library extensions	350
Functional extensions	352
Single Server Editions (SSE)	360
License	361
Migration	361
Media	361
Manuals	362
License migration to Data Protector A.06.10	362
Data Protector A.05.10, A.05.50, and A.06.00	362
Graphical license overview	363
Data Protector licensing forms	367
B Appendix B	371
In this appendix	371
Installing on HP-UX, Solaris, and Linux systems using native tools	371
Installing a Cell Manager on HP-UX systems using swinstall	371
Installing the Cell Manager on Solaris systems using pkgadd	373

Installing the Cell Manager on Linux systems using rpm	375
Installing an Installation Server on HP-UX systems using swinstall	378
Installing an Installation Server on Solaris systems using pkgadd	379
Installing an Installation Server on Linux systems using rpm	383
Installing the clients	388
Upgrading on HP-UX, Solaris, and Linux systems using native tools	388
Upgrading Data Protector on HP-UX systems using swinstall	388
Upgrading Data Protector on Solaris systems using pkgadd	389
Upgrading Data Protector on Linux systems using rpm	391
Setting up the TCP/IP protocol on Windows systems	392
Installing and configuring the TCP/IP protocol on Windows	393
Checking the TCP/IP setup	396
Changing the Cell Manager name	398
Changing the default port number	399
Preparing a NIS server	401
Using tape and robotics drivers on Windows	403
Creating device files (SCSI Addresses) on Windows	407
SCSI robotics configuration on HP-UX	408
Creating device files on HP-UX	412
Setting a SCSI controller's parameters	415
Finding the unused SCSI addresses on HP-UX	415
Finding the unused SCSI target IDs on Solaris	417
Updating the device and driver configuration on a Solaris system	418
Updating configuration files	418
Creating and checking device files	421
Finding unused SCSI target IDs on a Windows system	422
Setting SCSI IDs on an HP StorageWorks 330fx library	423
Connecting backup devices	424
Connecting an HP StorageWorks 24 standalone device	428
Connecting an HP StorageWorks DAT Autoloader	429
Connecting an HP StorageWorks DLT Library 28/48-Slot	431
Connecting a Seagate Viper 200 LTO Ultrium Tape Drive	436
Checking the General Media Agent Installation on Novell NetWare	438
Identifying the storage device	439
Testing the general Media Agent startup	439
Testing the HPUMA.NLM and the HPDEVBRA.NLM startup	442
Installing Data Protector on Microsoft Cluster with Veritas Volume Manager	443
Configuration files path changes in Data Protector A.06.10	444
Configuration files on UNIX	444
Configuration files on Windows	446
Command line changes after upgrading to Data Protector A.06.10	447

C Appendix C	467
Using CD-ROMs as the installation media	467
Data Protector installation CD-ROMs	467
Additional steps and tasks when installing Data Protector from CD-ROMs	470
Installing the UNIX Cell Manager from CD-ROMs	470
Installing the UNIX Installation Server from CD-ROMs	472
Installing UNIX Clients from CD-ROMs	473
Additional steps and tasks when upgrading Data Protector from CD-ROMs	473
Upgrading a UNIX Cell Manager	474
Upgrading a UNIX Installation Server	475
Glossary	479
Index	535

Figures

1 Data Protector graphical user interface	28
2 Data Protector Cell	34
3 Data Protector installation concept	35
4 Data Protector graphical user interface	40
5 Installation procedure	42
6 Selecting the installation type	55
7 Selecting software components	56
8 Component summary list	57
9 Installation status page	57
10 Selecting AutoPass for installation	58
11 Selecting the installation type	67
12 Component selection summary page	68
13 Installation status page	68
14 Selecting clients	79
15 Selecting components	80
16 Selecting clients	82
17 Selecting components	83
18 Choosing the Cell Manager	89
19 Component selection summary page	90
20 Installation summary page	90
21 Kernel configuration Window	95
22 Format of a device filename:	114
23 Format of a device filename	118
24 Selecting language support at setup	185

25	Installing language support remotely	186
26	Selecting the installation type	194
27	Selecting the cluster resource	195
28	Entering the account information	196
29	Component selection page	197
30	Installation status page	198
31	Data Protector user account	199
32	Data Protector user account	201
33	Importing a client to the cell TBD	209
34	Importing a Microsoft Cluster Server client to a cell	211
35	Importing a MC/ServiceGuard, Veritas, or Novell NetWare Cluster Services client to a cell TBD	213
36	Exporting a client system	215
37	Securing a client	221
38	Enabling security on selected client(s)	222
39	Enabling security for all clients in the cell	223
40	Verifying patches installed	230
41	Component selection summary page	262
42	Installation status page	262
43	Selecting AutoPass for installation	263
44	IDB conversion after upgrade	284
45	Selecting the components	305
46	Component selection summary page	306
47	Installation status page	306
48	Used capacity calculation scenario	313
49	ZDB-to-Disk sessions	316
50	ZDB-to-Tape sessions	317
51	ZDB-to-Disk+Tape sessions	318
52	Direct backup sessions	319

53	HP Data Protector product structure TBD	321
54	HP AutoPass wizard	325
55	Data Protector order tool example TBD	332
56	HP Data Protector product structure TBD	348
57	Starter Pack for HP-UX	363
58	Mixed environment	363
59	61 - 250 slot libraries - example 1	364
60	61 - 250 slot libraries - example 2	364
61	Online backup	365
62	Manager-of-Managers	365
63	Advanced backup to disk	366
64	Zero downtime backup	366
65	Single Server Edition	367
66	SD install - software selection window	373
67	The TCP/IP properties window on Windows	394
68	Advanced TCP/IP settings on Windows	395
69	The DNS suffix and NetBIOS computer name on Windows	396
70	Driver properties	404
71	Medium changer properties	406
72	Disabling robotics drivers	407
73	Tape drive properties	408
74	SCSI controlled devices	409
75	Managing devices	409
76	Status of the SCSI pass-through driver (sctl)	410
77	Status of the SCSI pass-through driver - spt	411
78	List of connected devices	413
79	The output of ioscan -f on an HP-UX system:	416
80	Device settings	423

Tables

1	Edition history	17
2	Document conventions	26
3	Data Protector DVD-ROM list	36
4	Installing Data Protector client systems	69
5	Installing integrations	71
6	Other installations	72
7	Data Protector component codes	148
8	Data Protector software component dependencies on HP-UX	246
9	Data Protector software component dependencies on Solaris	247
10	File name conversion impact on a Windows Cell Manager	280
11	File name conversion impact on a UNIX Cell Manager	281
12	Return messages	336
13	HP Data Protector Starter Pack license numbers	348
14	HP Data Protector drive extensions	350
15	HP Data Protector drive extensions	351
16	HP Data Protector library extensions	351
17	HP Data Protector on-line extension	352
18	HP Data Protector open file backup extension	353
19	HP Data Protector Manager-of-Managers extension	353
20	HP Data Protector Media Operations extension	354
21	HP Data Protector advanced backup to disk extension	354
22	HP Data Protector backup to HP IAP extension	356
23	HP Data Protector Zero Downtime Backup (ZDB) extension	357
24	HP Data Protector Instant Recovery extension	358

25	HP Data Protector direct backup extension	358
26	HP Data Protector direct backup using NDMP	359
27	HP Data Protector encryption extension	359
28	HP Data Protector functional extensions printed manuals	359
29	HP Data Protector SSE license numbers	360
30	The content of the new /etc/opt/omni/client directory	444
31	The content of the new /var/opt/omni/server directory	445
32	The content of the new Data_Protector_home\Config\client directory	446
33	Upgrade from Data Protector A.05.10	447
34	Upgrade from Data Protector A.05.50	455
35	Upgrade from Data Protector A.06.00	460
36	Upgrade from Application Recovery Manager A.06.00	464
37	Data Protector CD-ROM list	467

Publication history

Guide updates may be issued between editions to correct errors or document product changes. To ensure that you receive updated or new editions, subscribe to the appropriate product support service. See your HP sales representative for details.

Table 1 Edition history

Part number	Guide edition	Product
B6960-90058	August 2002	Data Protector Release A.05.00
B6960-90079	May 2003	Data Protector Release A.05.10
B6960-90107	October 2004	Data Protector Release A.05.50
B6960-96002	July 2006	Data Protector Release A.06.00
TBD	TBD	Data Protector Release A.06.10

About this guide

This guide provides information about:

- installing the Data Protector network product
- prerequisites that must be met before starting the installation procedure
- upgrading and licensing

Intended audience

This guide is intended for administrators responsible for installing and maintaining the environment and backup administrators responsible for planning, installing, and managing the backup environment.

Conceptual information can be found in the *HP Data Protector concepts guide*, which is recommended to fully understand the fundamentals and the model of Data Protector.

Documentation set

Other documents and online Help provide related information.

Guides

Data Protector guides are available in printed format and in PDF format. Install the PDF files during the Data Protector setup procedure by selecting the `English documentation` and `Help` component on Windows or the `OB2-DOCS` component on UNIX. Once installed, the guides reside in the `Data_Protector_home\docs` directory on Windows and in the `/opt/omni/doc/C/` directory on UNIX.

You can find these documents from the Manuals page of the HP Business Support Center website:

<http://www.hp.com/support/manuals>

In the Storage section, click **Storage Software** and then select your product.

- *HP Data Protector concepts guide*
This guide describes Data Protector concepts and provides background information on how Data Protector works. It is intended to be used with the task-oriented online Help.
- *HP Data Protector installation and licensing guide*
This guide describes how to install the Data Protector software, taking into account the operating system and architecture of your environment. This guide also gives details on how to upgrade Data Protector, as well as how to obtain the proper licenses for your environment.
- *HP Data Protector troubleshooting guide*
This guide describes how to troubleshoot problems you may encounter when using Data Protector.
- *HP Data Protector disaster recovery guide*
This guide describes how to plan, prepare for, test and perform a disaster recovery.
- *HP Data Protector integration guides*
These guides describe how to configure and use Data Protector to back up and restore various databases and applications. They are intended for backup administrators or operators. There are four guides:
 - *HP Data Protector integration guide for Microsoft applications: SQL Server, SharePoint Portal Server, Exchange Server, and Volume Shadow Copy Service*
This guide describes the integrations of Data Protector with the following Microsoft applications: Microsoft Exchange Server, Microsoft SQL Server, and Volume Shadow Copy Service.
 - *HP Data Protector integration guide for Oracle and SAP*
This guide describes the integrations of Data Protector with Oracle, SAP R3, and SAP DB.
 - *HP Data Protector integration guide for IBM applications: Informix, DB2, and Lotus Notes/Domino*
This guide describes the integrations of Data Protector with the following IBM applications: Informix Server, IBM DB2, and Lotus Notes/Domino Server.
 - *HP Data Protector integration guide for Sybase, Network Node Manager, Network Data Management Protocol, and VMware*
This guide describes the integrations of Data Protector with Sybase, Network Node Manager, Network Data Management Protocol, and VMware.
- *HP Data Protector integration guide for HP Service Information Portal*

This guide describes how to install, configure, and use the integration of Data Protector with HP Service Information Portal. It is intended for backup administrators. It discusses how to use the OpenView applications for Data Protector service management.

- *HP Data Protector integration guide for HP Reporter*

This manual describes how to install, configure, and use the integration of Data Protector with HP Reporter software. It is intended for backup administrators. It discusses how to use the applications for Data Protector service management.

- *HP Data Protector integration guide for HP Operations Manager for UNIX*

This guide describes how to monitor and manage the health and performance of the Data Protector environment with HP Operations Manager software software and HP Service Navigator on UNIX.

- *HP Data Protector integration guide for HP Operations Manager for Windows*

This guide describes how to monitor and manage the health and performance of the Data Protector environment with HP Operations Manager software software and HP Service Navigator on Windows.

There are two versions of the guide:

- for OVO 7.1x, 7.2x
- for OVO 7.5

- *HP Data Protector software integration guide for HP Performance Manager software and HP Performance Agent software*

This guide provides information about how to monitor and manage the health and performance of the Data Protector environment with HP Performance Manager (PM) software and HP Performance Agent (PA) software on Windows, HP-UX, Solaris and Linux.

- *HP Data Protector zero downtime backup concepts guide*

This guide describes Data Protector zero downtime backup and instant recovery concepts and provides background information on how Data Protector works in a zero downtime backup environment. It is intended to be used with the task-oriented *HP Data Protector zero downtime backup administrator's guide* and the *HP Data Protector zero downtime backup integration guide*.

- *HP Data Protector zero downtime backup administrator's guide*

This guide describes how to configure and use the integration of Data Protector with HP StorageWorks Virtual Array, HP StorageWorks Enterprise Virtual Array, EMC Symmetrix Remote Data Facility and TimeFinder, and HP StorageWorks Disk Array XP. It is intended for backup administrators or operators. It covers the zero downtime backup, instant recovery, and the restore of filesystems and disk images.

- *HP Data Protector zero downtime backup integration guide*
This guide describes how to configure and use Data Protector to perform zero downtime backup, instant recovery, and standard restore of Oracle, SAP R/3, Microsoft Exchange Server, and Microsoft SQL Server databases. The guide also describes how to configure and use Data Protector to perform backup and restore using the Microsoft Volume Shadow Copy Service.
- *HP Data Protector MPE/iX system user guide*
This guide describes how to configure MPE/iX clients and how to back up and restore MPE/iX data.
- *HP Data Protector Media Operations user guide*
This guide provides tracking and management of offline storage media. It is intended for network administrators responsible for maintaining and backing up systems. It describes the tasks of installing and configuring the application, performing daily media operations and producing reports.
- *HP Data Protector product announcements, software notes, and references*
This guide gives a description of new features of HP Data Protector A.06.10. It also provides information on supported configurations (devices, platforms and online database integrations, SAN, and ZDB), required patches, and limitations, as well as known problems and workarounds. An updated version of the supported configurations is available at <http://www.hp.com/support/manuals>
There are also four other *Product announcements, software notes and references*, which serve a similar purpose for the following:
 - HP Operations Manager software software UNIX integration
 - HP Operations Manager software software Windows integration
 - HP Service Information Portal and HP Reporter software
 - HP Performance Manager software and HP Performance Agent integration
 - HP Media Operations

Online help

Data Protector provides context-sensitive (F1) Help and Help Topics for Windows and UNIX platforms.

You can access the online help from the top-level directory on the installation DVD without installing Data Protector:

- **Windows:** Unzip `DP_help.zip` and open `DP_help.chm`.
- **UNIX:** Unpack the zipped tar file `DP_help.tar.gz`, and access the online help system through `DP_help.htm`.

Documentation map

Abbreviations

Abbreviations in the documentation map that follows are explained below. The guide titles are all preceded by the words “HP Data Protector”.

Abbreviation	Guide
CLI	Command line interface reference
Concepts	Concepts guide
DR	Disaster recovery guide
GS	Getting started guide
Help	Online Help
IG-IBM	Integration guide—IBM applications
IG-MS	Integration guide—Microsoft applications
IG-O/S	Integration guide—Oracle, SAP R/3, and SAP DB/MaxDB
IG-OMU	Integration guide—HP Operations Manager software software, UNIX
IG-OMW	Integration guide—HP Operations Manager software software, Windows
IG-PM/PA	Integration guide—Performance Manager and Performance Agent software
IG-Report	Integration guide—HP Reporter software
IG-SIP	Integration guide—HP Service Information Portal
IG-Var	Integration guide—Sybase, Network Node Manager, NDMP and VMware
Install	Installation and licensing guide
MO GS	Media Operations getting started guide

Abbreviation	Guide
MO RN	Media Operations product announcements, software notes, and references
MO UG	Media Operations user guide
MPE/iX	MPE/iX system user guide
PA	Product announcements, software notes, and references
Trouble	Troubleshooting guide
ZDB Admin	ZDB administrator's guide
ZDB Concpt	ZDB concepts guide
ZDB IG	ZDB integration guide

Map

The following table shows where to find information of different kinds. Shaded squares are a good place to look first.

Integrations

Look in these guides for details of the following integrations:

Integration	Guide
HP Operations Manager software software	IG-OMU, IG-OMW
HP Performance Manager software	IG-PM/PA
HP Performance Agent software	IG-PM/PA
HP Reporter Light	IG-OMW
HP Reporter software	IG-R
HP Service Information Portal	IG-SIP
HP StorageWorks Disk Array XP	all ZDB
HP StorageWorks Enterprise Virtual Array (EVA)	all ZDB
HP StorageWorks Virtual Array (VA)	all ZDB
IBM DB2 UDB	IG-IBM
Informix	IG-IBM
Lotus Notes/Domino	IG-IBM
Media Operations	MO User
MPE/iX System	MPE/iX
Microsoft Exchange Server	IG-MS, ZDB IG
Microsoft Exchange Single Mailbox	IG-MS
Microsoft SQL Server	IG-MS, ZDB IG
Microsoft Volume Shadow Copy Service (VSS)	IG-MS, ZDB IG
NDMP Server	IG-Var
Network Node Manager (NNM)	IG-Var

Integration	Guide
Oracle	IG-O/S
Oracle ZDB	ZDB IG
SAP DB	IG-O/S
SAP R/3	IG-O/S, ZDB IG
Sybase	IG-Var
Symmetrix (EMC)	all ZDB
VMware	IG-Var

Document conventions and symbols

Table 2 Document conventions

Convention	Element
Blue text: Table 2 on page 26	Cross-reference links and e-mail addresses
Blue, underlined text: http://www.hp.com	website addresses
<i>Italic text</i>	Text emphasis
Monospace text	<ul style="list-style-type: none"> • File and directory names • System output • Code • Commands, their arguments, and argument values
<i>Monospace, italic text</i>	<ul style="list-style-type: none"> • Code variables • Command variables
text	Emphasized monospace text

 **CAUTION:**

Indicates that failure to follow directions could result in damage to equipment or data.

 **IMPORTANT:**

Provides clarifying information or specific instructions.

 **NOTE:**

Provides additional information.

 **TIP:**

Provides helpful hints and shortcuts.

Data Protector graphical user interface

Data Protector provides a cross-platform (Windows and UNIX) graphical user interface. You can use the original Data Protector GUI or the Data Protector Java GUI. Refer to the online Help for information about the Data Protector graphical user interface.

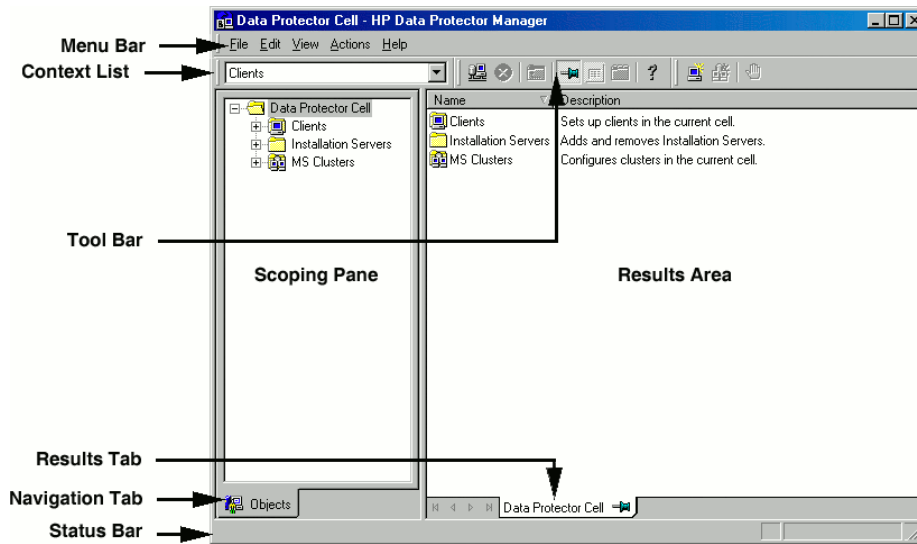

Figure 1 Data Protector graphical user interface

General Information

General information about Data Protector can be found at <http://www.hp.com/go/dataprotector>.

HP technical support

For worldwide technical support information, see the HP support website:

<http://www.hp.com/support>

Before contacting HP, collect the following information:

- Product model names and numbers
- Technical support registration number (if applicable)
- Product serial numbers
- Error messages
- Operating system type and revision level
- Detailed questions

Subscription service

HP recommends that you register your product at the Subscriber's Choice for Business website:

<http://www.hp.com/go/e-updates>

After registering, you will receive e-mail notification of product enhancements, new driver versions, firmware updates, and other product resources.

HP websites

For additional information, see the following HP websites:

- <http://www.hp.com>
- <http://www.hp.com/go/software>
- http://www.hp.com/service_locator
- <http://www.hp.com/support/manuals>
- <http://www.hp.com/support/downloads>

Documentation feedback

HP welcomes your feedback.

To make comments and suggestions about product documentation, please send a message to AppRM.DocFeedback@hp.com. All submissions become the property of HP.

1 Overview of the installation procedure

In this chapter

This chapter provides an overview of the Data Protector installation procedure and introduces concepts that apply to the installation. The chapter also introduces Data Protector Cell Manager and Data Protector.

Overview of the installation procedure

A Data Protector backup environment is a set of systems with a common backup policy located in the same time zone and existing on the same LAN/SAN. This network environment is referred to as a Data Protector **cell**. A typical cell consists of a Cell Manager, Installation Servers, clients, and backup devices.

The **Cell Manager** is the main system that manages the cell from a central point. It contains the Data Protector internal database (IDB) and runs core Data Protector software and session managers.

The IDB keeps track of backed up files and the cell configuration.

The **Installation Server** (IS) is a separate system or a Cell Manager component that contains the Data Protector software repository used for remote client installations. This Data Protector feature greatly facilitates the software installation process, particularly for remote clients.

A cell typically consists of one Cell Manager and several clients. A computer system becomes a Data Protector **client** as soon as one of the Data Protector software components is installed on the system. When client components are installed on a system depends on the role of that system in your backup environment. Data Protector components can be installed either locally on a single system, or onto several systems from Installation Servers.

The **User Interface** component is needed to access the Data Protector functionality and is used to perform all configuration and administration tasks. It must be installed on systems used for backup administration. Data Protector provides a graphical user interface (GUI) and command-line interface (CLI).

Client systems with disks that need to be backed up must have an appropriate Data Protector **Disk Agent** components installed. The Disk Agent enables you to back up data from the client disk or restore it.

Client systems that are connected to a backup device must have a **Media Agent** component installed. This software manages backup devices and media. Data Protector features two Media Agents: the **General Media Agent** and the **NDMP Media Agent**. The NDMP Media Agent is only needed on client systems that control the backup of an NDMP server (on client systems controlling NDMP dedicated drives). In all other cases the two Media Agents are interchangeable.

Before installing Data Protector on your network, define the following:

- The system on which the Cell Manager will be installed. See the support matrices at <http://www.hp.com/support/manuals> for supported operating systems and versions.

There can only be one Cell Manager per cell. Data Protector cannot be run without a Cell Manager installed.

- Systems that will be used to access the Data Protector functionality through the user interface. These systems must have the User Interface component installed.
- Systems that will be backed up. These must have the Disk Agent component installed for filesystem backup and the relevant Application Agent component for online database integrations.
- Systems to which the backup devices will be connected. These must have a Media Agent component installed.
- The system(s) on which the Data Protector Installation Server(s) will be installed. Two types of Installation Servers are available for remote software installation: one for UNIX clients and one for Windows clients.

The choice of computer for the Installation Server is independent of the Cell Manager and the system(s) on which the User Interface is installed. The Cell Manager and Installation Server can be installed on the same system (if they run on the same platform) or on different systems.

An Installation Server can be shared between multiple Data Protector cells.

 **NOTE:**

The Installation Server for Windows must be installed on a Windows system. The Installation Server for UNIX must be installed on an HP-UX, Solaris, or Linux system. Refer to the *HP Data Protector product announcements, software notes, and references* for the supported operating system versions.

 **IMPORTANT:**

When installing a Data Protector Cell Manager, Installation Server or client on Solaris systems, make sure to save all your files from the `/usr/omni` directory to some other directory. The Data Protector installation deletes all the files from the `/usr/omni` directory.

After you have defined the roles of the systems in your future Data Protector cell, the installation procedure comprises the following general steps:

1. Checking the prerequisites for installation.
2. Installing the Data Protector Cell Manager.
3. Installing the Installation Server(s) and the User Interface.
4. Installing client systems either remotely (recommended option, where possible), or locally from the DVD-ROM.

 **NOTE:**

You cannot remotely install a Data Protector client on a Windows system if an Installation Server has already been installed on this system. To install an Installation Server and client component(s) on the same system, you must perform a local client installation from the Data Protector Windows installation DVD-ROM. In the Custom Setup window, select all desired client components and the Installation Server component.

Remote installation is also not possible for Windows Me/XP Home Edition, MPE, and Novell NetWare clients. These have to be installed locally.

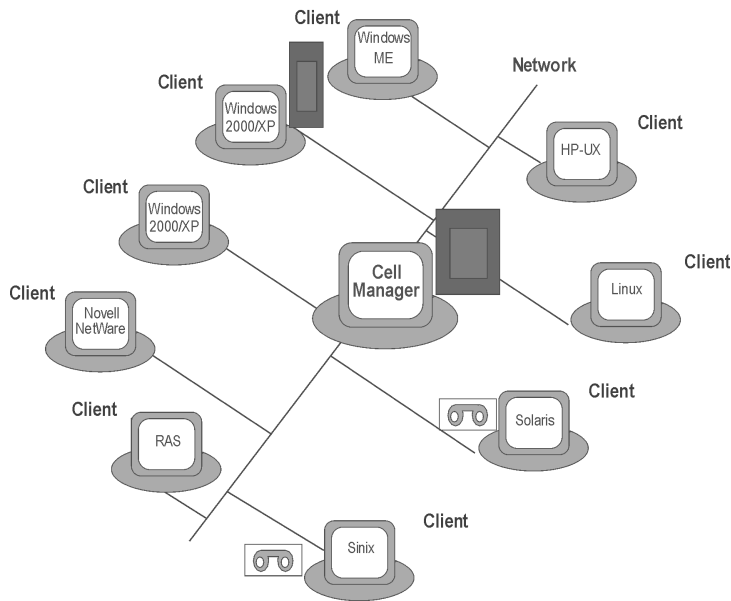

Figure 2 Data Protector Cell

The remote installation concept

Once you have installed the Data Protector Cell Manager, User Interface, and Installation Server(s) (at least one Installation Server is needed for each platform, UNIX and Windows), you can distribute Data Protector software to clients using operating systems on which remote installation is supported. See [Figure 3](#) on page 35 .

Every time you perform a remote installation, you access the Installation Server through the GUI. The User Interface component may be installed on the Cell Manager, although this is not a requirement. It would be prudent to install the User Interface on several systems so that you can access the Cell Manager from different locations.

Client software can be distributed to any Windows system, except Windows Me/XP HE, from an Installation Server for Windows.

Windows Me/XP HE client systems must be installed locally from the Data Protector DVD-ROM for Windows.

Data Protector also supports Novell NetWare clients, although there is no remote client installation. Installation is performed through a Windows system connected to the Novell network.

Client software can be installed remotely on HP-UX, Solaris, Sinix, Linux, AIX, and other supported UNIX operating systems from an Installation Server for UNIX. For a list of supported platforms, refer to HP Data Protector product announcements, software notes, and references.

For UNIX operating systems on which remote installation is not supported, or if you do not install an Installation Server for UNIX, you can install UNIX clients locally, from the Data Protector UNIX installation DVD-ROM.

Note that there are some exceptions that require remote installation only.

For further information on available installation methods for the various Data Protector clients, refer to “[Installing Data Protector clients](#)” on page 69.

For the procedure for installing UNIX clients locally, refer to “[Local installation of UNIX clients](#)” on page 146.

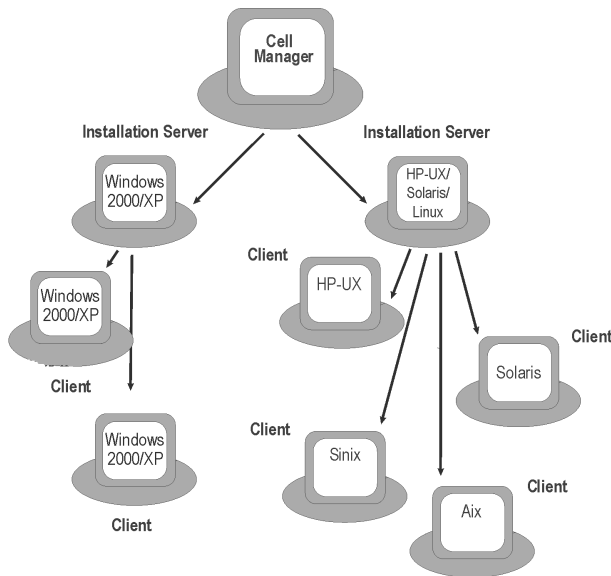

Figure 3 Data Protector installation concept

Data Protector installation DVD-ROMs

Data Protector supports various operating systems and several processor architectures. Consequently, 2 DVD-ROMs are required to cover all platforms. [Table 3](#) on page 36 lists the components found on the DVD-ROMs.

 **NOTE:**

The preferred installation media for Data Protector are DVD-ROMs. If you are installing from CD-ROMs instead of DVD-ROMs, see [Appendix C](#) on page 467, where a list of CD-ROMs is provided and the differences between the installation procedures are described.

Table 3 Data Protector DVD-ROM list

DVD Num.	DVD-ROM Title	Contents
1	Data Protector Starter Pack for Windows Includes Open File Backup; Media Operations; and agents for Netware, MPE, and OpenVMS clients	<ul style="list-style-type: none">• Cell Manager and Installation Server for Windows on 32-bit and 64-bit (AMD64/Intel EM64T) systems• AutoPass¹• All English manuals in PDF format (in the DOCS directory)• Windows IA64 clients• Novell NetWare clients• OpenVMS clients (Alpha and IA64 systems)• MPE clients• Open File Manager installation package• Product Demo for Windows platforms• Product information• Installation package for Media Operations
2	Data Protector Starter Pack for HP-UX, Solaris, and Linux Includes agents for HP-UX, Solaris, and Linux clients	<ul style="list-style-type: none">• Cell Manager and Installation Server for HP-UX (PA-RISC, IA64), Solaris, and Linux• Clients for other UNIX systems• AutoPass²• All English manuals in PDF format (in the DOCS directory)• OpenView Integration Packages

¹AutoPass is not available on Windows x64, Windows Vista, and Windows Server 2008 operating systems.

²AutoPass is not available on Linux.

Choosing the Cell Manager system

The Cell Manager is the main system in the Data Protector cell. The Cell Manager does the following:

- Manages the cell from one central point.
- Contains the IDB (files with information about backup, restore and media management sessions).
- Runs the core Data Protector software.
- Runs the Session Manager that starts and stops backup and restore sessions and writes session information to the IDB.

Before deciding on which system in your environment to install the Cell Manager, be aware of the following:

- Supported platforms

The Cell Manager can be installed on either the Windows, HP-UX, Solaris or Linux platform. See <http://www.hp.com/support/manuals> for details on supported versions/releases of these platforms.

- Reliability of the Cell Manager system

Since the Cell Manager contains the IDB and since backup and restore cannot be performed if the Cell Manager is down, it is important to choose a very reliable system in your environment for the installation.

- Database growth and required disk space

The Cell Manager holds the Data Protector Internal Database (IDB). The IDB contains information regarding the backed up data and its media, session messages and devices. The IDB can grow to a significant size, depending on your environment. For example, if the majority of backups are filesystem backups, then a typical IDB size would be 2% of the disk space used by the backed up data. You can use the `IDB_capacity_planning.xls` table (located on the Data Protector installation medium) to estimate the size of the IDB.

Refer to the *online Help index: "growth and performance of the IDB"* for information on planning and managing the size and growth of the database.

Refer to *HP Data Protector product announcements, software notes, and references* for minimum disk space requirements for the IDB.



NOTE:

You do not have to use the Cell Manager as the graphical user interface system. For example, you may have a UNIX Cell Manager, but a user interface component installed on a Windows client.

What's next?

To determine the minimum requirements for your future Cell Manager system, refer to ["Installing the Data Protector Cell Manager \(CM\) and Installation Server\(s\) \(IS\)"](#) on page 42.

Choosing the Data Protector user interface system

Data Protector provides a GUI and CLI for Windows, HP-UX, Solaris, and Linux platforms. The user interface is installed as a Data Protector software component.

The system selected to control the cell will be used by a network administrator or a backup operator.

However, in a large computer environment, it may be desirable to run the user interface on several systems, and if the environment is a mixed one, on various platforms.

For instance, if you have a mixed UNIX network, and the user interface installed on at least one Solaris or HP-UX system, you can export the display of that user interface to any other UNIX system running an X-server. However, for purposes of performance, it is recommended to install the Data Protector GUI interface on all systems that will be used to control the Data Protector cell.

If you have an office area with many Windows systems to back up, you might, as a matter of convenience, want to control local backup and restore operations from a local Windows system. In this case, install the user interface component on a Windows system. In addition, the Data Protector GUI on Windows systems is simpler to handle in heterogeneous environments, because changing the locale is not necessary.

On UNIX Cell Manager platforms, you can use the Data Protector Java GUI where it is supported, or use the `omniusers` command to create a remote user account on the Cell Manager. You can then use this user account to start the GUI and connect to the Cell Manager on any other system on which the Data Protector GUI has been installed. Refer to the `omniusers` man page for details.

See <http://www.hp.com/support/manuals> for details on supported operating system versions/releases for the user interface. For more information on local language support and usage of non-ASCII characters in file names, refer to the online Help index: “language settings, customizing”.

Once you have installed the user interface on a system in the cell, you can remotely access the Cell Manager from that system. You do not have to use the graphical user interface system on the Cell Manager.

The Data Protector graphical user interface

The Data Protector GUI is a powerful tool that provides easy access to the Data Protector functionality. The main window contains several views, such as **Clients**, **Users**, **Devices & Media**, **Backup**, **Restore**, **Copy & Consolidation**, **Reporting**, **Monitor**, **Instant Recovery**, and **Internal Database**, allowing you to perform all related tasks.

For example, in the **Clients** view, you can remotely install (add) clients by specifying all the target systems and defining the installation paths and options which are sent to the specified Installation Server. When the setup on the client is running, only installation specific messages are displayed in the monitor window.

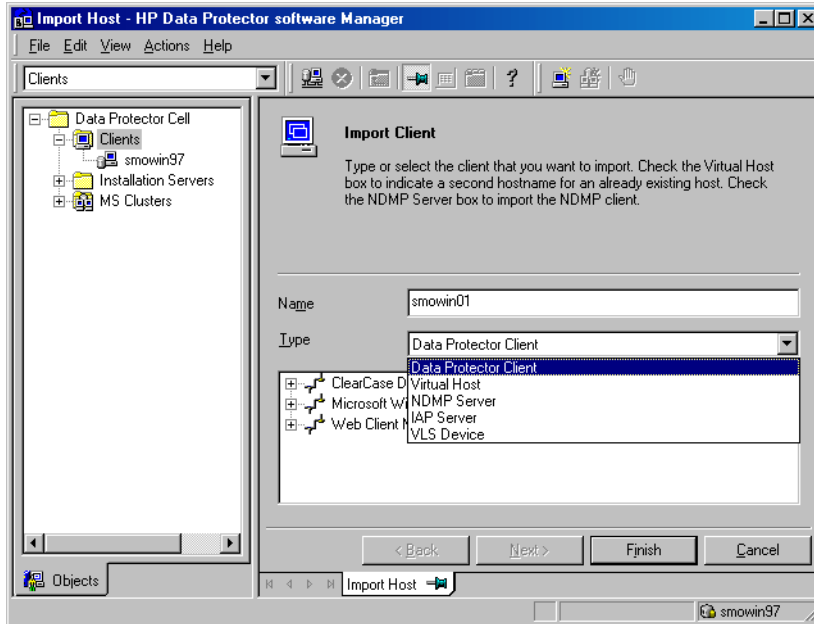

Figure 4 Data Protector graphical user interface

See also [Figure 1](#) on page 28 in the Preface, which defines the most important areas of the Data Protector GUI.



NOTE:

On UNIX, specific local settings are required on the system on which the Data Protector GUI is running, before starting the GUI. This will enable you to switch character encoding in GUI and thus choose the right encoding to correctly display non-ASCII characters in filenames and session messages. Refer to the online Help index: “setting, locale for GUI on UNIX” for details.

2 Installing Data Protector on your network

In this chapter

This chapter contains detailed instructions about:

- Installing the Data Protector Cell Manager (CM) and Installation Servers (IS). Refer to [“Installing the Data Protector Cell Manager \(CM\) and Installation Server\(s\) \(IS\)”](#) on page 42.
- Installing the Data Protector clients. Refer to [“Installing Data Protector clients”](#) on page 69.
- Installing the Data Protector integration clients. Refer to [Installing the Data Protector integration clients](#).
- Installing the localized Data Protector user interface. Refer to [“Installing localized Data Protector user interface”](#) on page 184.
- Installing the Data Protector Single Server Edition. Refer to [“Installing the Data Protector Single Server Edition”](#) on page 187.
- Installing Data Protector Web Reporting. Refer to [“Installing Data Protector web reporting”](#) on page 189.
- Installing Data Protector on MC/ServiceGuard. Refer to [“Installing Data Protector on MC/ServiceGuard”](#) on page 190.
- Installing Data Protector on a Microsoft Cluster Server. Refer to [“Installing Data Protector on Microsoft Cluster Server”](#) on page 191.
- Installing Data Protector Clients on a Veritas Cluster. Refer to [“Installing Data Protector clients on a Veritas Cluster”](#) on page 202.
- Installing Data Protector Clients on a Novell NetWare Cluster. Refer to [“Installing Data Protector clients on a Novell NetWare Cluster”](#) on page 203.

Installing the Data Protector Cell Manager (CM) and Installation Server(s) (IS)

Refer to [Figure 5](#) on page 42 and for the flow of installation procedure:

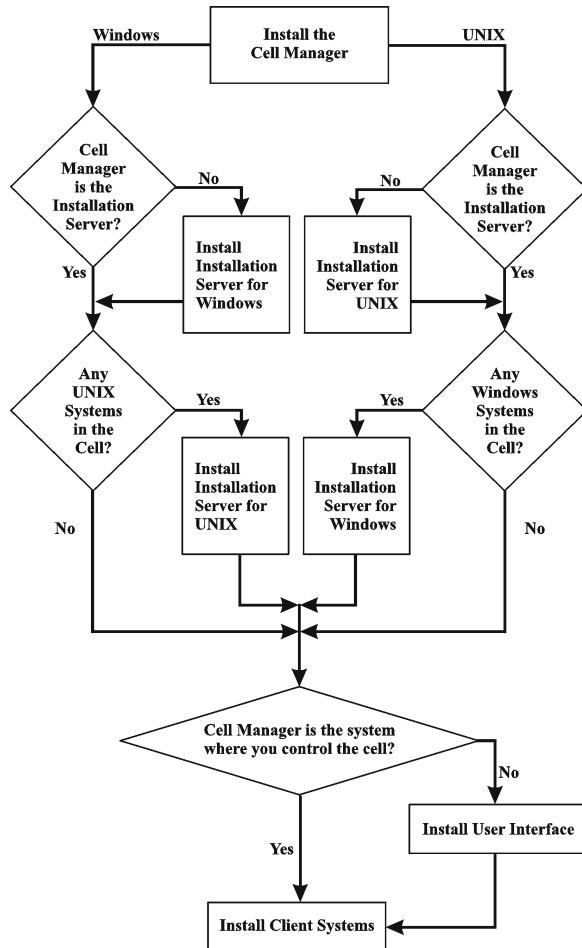

Figure 5 Installation procedure

If you install the Cell Manager and the Installation Server on the same system, you can perform this task in one step.

 **IMPORTANT:**

All configuration and session information files in a Data Protector cell are stored on the Cell Manager. It is difficult to transfer this information to another system. Therefore, ensure that the Cell Manager is a reliable system in a stable, controlled environment.

 **NOTE:**

The procedures in this chapter for installing the Cell Manager, Installation Server, and for local installation of clients are written for DVD-ROM installation media. If you are using CD-ROM media, see also the [Appendix C](#) on page 467, where a list of CD-ROMs is provided together with the differences in the installation procedure.

Installing a UNIX Cell Manager

This section provides step-by-step instructions on how to install a UNIX Cell Manager. If you want to install the Windows Cell Manager only, refer to “[Installing a Windows Cell Manager](#)” on page 52.

Prerequisites

- The HP-UX, Solaris, or Linux system that will become the Cell Manager must:
 - Have sufficient disk space for the Data Protector software. Refer to the *HP Data Protector product announcements, software notes, and references* for details. You can overcome a shortage of space by installing to linked directories, but you should first refer to “[The installed directory structure on HP-UX, Solaris, and Linux](#)” on page 48 and “[Allocating more disk space for the Cell Manager installation](#)” on page 52.
 - Have sufficient disk space (about 2% of the planned data to be backed up) for the IDB. Refer to the *HP Data Protector product announcements, software notes, and references* for details. Note that the current IDB design allows the database binary files to be relocated if growth in database size makes it necessary. See the online Help index: “IDB, calculating the size of”.
 - Support long filenames. To find out if your filesystem supports long filenames use the `getconf NAME_MAX directory` command.
 - Have the `inetd` daemon up and running.

- Have the port number 5555 (default) free. If this is not the case, refer to [“Changing the default port number”](#) on page 399.
- Have the TCP/IP protocol installed and running. The protocol must be able to resolve hostnames.
- Have access to a DVD-ROM drive.
- Recognize the Cell Manager, if using a NIS server. Refer to [“Preparing a NIS server”](#) on page 401.
- Have the port number 5556 free to install Java GUI Server.
- For Java GUI Client, Java Runtime Environment (JRE) 1.5_06 or later minor version (for example, 1.5_07) is required.
- You need `root` permissions on the target system.

 **NOTE:**

On Cell Manager platforms where the original Data Protector GUI is not supported, you can use the Data Protector Java GUI or install the original Data Protector GUI on a system where it is supported. Use the `omniusers` command to create a remote user account on the new Cell Manager. You can then use this user account on any system with the Data Protector GUI installed to start the GUI and connect to the new Cell Manager. Refer to the `omniusers` man page.

Cluster-aware Cell Manager

Additional prerequisites and steps are required for installing a cluster-aware Cell Manager. Refer to [“Installing a cluster-aware Cell Manager”](#) on page 190.

 **NOTE:**

In a multiple-cell environment (MoM), all Cell Managers must have the same Data Protector version installed.

Recommendation

- **On UNIX** platforms, it is recommended to use Large file support (LFS). The recommendation applies to the file systems which hold an internal database, including DC binary files that are expected to grow larger than 2 GB.

Setting kernel parameters

On HP-UX, it is recommended to set the kernel parameter `maxdsiz` (Max Data Segment Size) or `maxdsiz_64` (for 64bit systems) to at least 134217728 bytes (128 MB), and the kernel parameter `semnu` (Number of Semaphore Undo Structures) to at least 256. After committing these changes, recompile the kernel and reboot the machine.

On Solaris, it is recommended to set the kernel parameter `shmsys:shminfo_shmmax` (maximum shared memory segment size (SHMMAX)) in `/etc/system` to at least 67108864 bytes (64 MB). After committing this change, reboot the machine.

Installation procedure



If you install the Cell Manager and Installation Server on the same system, you can perform the installation in one step by running `omnisetup.sh -CM -IS`.

For a description of the `omnisetup.sh` command, refer to the `README` file located in the `Mount_point/LOCAL_INSTALL` directory on the DVD-ROM or to the *HP Data Protector command line interface reference* located in the `Mount_point/DOCS/C/MAN` directory on the DVD-ROM.

Follow the procedure below to install the Cell Manager on an HP-UX, Solaris, or Linux system:

1. Insert and mount the UNIX installation DVD-ROM to a mount point.

For example:

```
mkdir /dvdrom
```

```
mount /dev/dsk/c0t0d0 /dvdrom
```

Optionally, you can install Data Protector from a depot on the disk:

- To copy the `DP_DEPOT`, `AUTOPASS`, and `LOCAL_INSTALL` directories, where the installation files are stored, to your local disk, run:

```
mkdir directory
```

```
cp -r /dvdrom/platform_dir/DP_DEPOT directory
```

```
cp -r /dvdrom/platform_dir/AUTOPASS directory
```

```
cp -r /dvdrom/platform_dir/LOCAL_INSTALL directory
```

Where *platform_dir* is:

<code>hpux_ia</code>	HP-UX on IA-64 systems
----------------------	------------------------

<code>hpux_pa</code>	HP-UX on PA-RISC systems
----------------------	--------------------------

<code>linux_x86_64</code>	Linux systems on AMD64/Intel EM64T
---------------------------	------------------------------------

<code>solaris</code>	Solaris systems
----------------------	-----------------

- To copy the whole DVD-ROM to your local disk, run:

```
cp -r /dvdrom dvd_image_dir
```

2. Run the `omnisetup.sh` command.

To run this command from the DVD-ROM, type:

```
cd /dvdrom/LOCAL_INSTALL
./omnisetup.sh -CM
```

To start the installation from disk:

- If you have copied the `DP_DEPOT`, `AUTOPASS`, and `LOCAL_INSTALL` directories to your local disk in the *directory*, run:

```
cd directory/LOCAL_INSTALL
./omnisetup.sh -source directory -CM
```

- If you have copied the whole DVD-ROM to *dvd_image_dir*, run the `omnisetup.sh` command with the `-CM` parameter:

```
cd dvd_image_dir/LOCAL_INSTALL
./omnisetup.sh -CM
```

3. On HP-UX and Solaris `omnisetup.sh` prompts you to install or upgrade the HP AutoPass utility if you want to download and install passwords for the purchased licenses directly through the internet from the HP password delivery center web server. For more information on the AutoPass utility, see [“Obtaining and installing permanent passwords using the HP AutoPass utility”](#) on page 323 and the HP AutoPass online Help. It is recommended to install AutoPass.

If AutoPass is installed on MC/ServiceGuard, it must be installed on all nodes.

When prompted, press **Return** to install or upgrade AutoPass. If you do not want to install or upgrade AutoPass, enter **n**.

On Linux, HP AutoPass is not installed.

 **NOTE:**

If you have installed/upgraded the Cell Manager on Solaris 9 or Solaris 10, remotely install the Disk Agent on the Cell Manager after the installation/upgrade is complete, using an Installation Server. This will replace the generic Solaris Disk Agent with the Solaris 9 or Solaris 10 Disk Agent. Refer to [“Remote installation of Data Protector clients”](#) on page 77 or to the `ob2install` man page.

If you want to install an Installation Server for UNIX on your Cell Manager, you can do it at this point. Refer to [“Installing Installation Servers for UNIX”](#) on page 61 for the required steps.

The installed directory structure on HP-UX, Solaris, and Linux

When the installation completes, the core Data Protector software is located in the `/opt/omni/bin` directory and the Installation Server for UNIX in the `/opt/omni/databases/vendor` directory. The following list shows the Data Protector subdirectories and their contents:

IMPORTANT:

If you want to install Data Protector to linked directories, for instance:

```
/opt/omni/ -> /prefix/opt/omni/  
/var/opt/omni/ -> /prefix/var/opt/omni/  
/etc/opt/omni/ -> /prefix/etc/opt/omni/
```

you must create the links before the installation and ensure that the destination directories exist.

Refer to [“Allocating more disk space for the Cell Manager installation”](#) on page 52 for more information.

<code>/opt/omni/bin</code>	All commands
<code>/opt/omni/gui</code>	GUI items
<code>/opt/omni/help/C</code>	Online Help files
<code>/opt/omni/lbin</code>	Data Protector internal commands
<code>/opt/omni/sbin</code>	Superuser commands
<code>/opt/omni/sbin/install</code>	Installation scripts
<code>/etc/opt/omni</code>	Configuration information
<code>/opt/omni/lib</code>	Shared libraries for compression, data encoding, and device handling

<code>/opt/omni/doc/C</code>	Online documentation (optional)
<code>/var/opt/omni/log</code> and <code>/var/opt/omni/server/log</code>	Log files
<code>/opt/omni/lib/nls/C</code>	Message catalog files
<code>/opt/omni/lib/man</code>	Man pages
<code>/var/opt/omni/tmp</code>	Temporary files
<code>/var/opt/omni/server/db40</code>	IDB files. Refer to the online Help index: "IDB, location of directories" for details.
<code>/opt/omni/java/server</code>	Directory containing Java GUI Server executables
<code>/opt/omni/java/client</code>	Directory containing Java GUI Client executables

Configuring automatic startup and shutdown

The Data Protector installation procedure configures an automatic startup and shutdown of all Data Protector processes whenever a system is restarted. Some of this configuration is operating system dependent.

The following files are automatically configured:

HP-UX:

`/sbin/init.d/omni`

A script with startup and shutdown procedures.

`/sbin/rc1.d/K162omni`

A link to the `/sbin/init.d/omni` script that shuts down Data Protector.

`/sbin/rc2.d/S838omni`

A link to the `/sbin/init.d/omni` script that starts up Data Protector.

`/etc/rc.config.d/omni`

Contains an `omni` variable defining:

- omni=1 Data Protector is automatically stopped and started at system reboot. This is the default option.

- omni=0 Data Protector is not automatically stopped and started at system reboot.

Solaris:

`/etc/init.d/omni`

A script with startup and shutdown procedures.

`/etc/rc1.d/K09omni`

A link to the `/etc/init.d/omni` script that shuts down Data Protector.

`/etc/rc2.d/S97omni`

A link to the `/etc/init.d/omni` script that starts up Data Protector.

Linux:

`/etc/init.d/omni`

A script with startup and shutdown procedures.

`/etc/rcinit_level.d/K10omni`

A link to the `/etc/init.d/omni` script that shuts down Data Protector.

Where `init_level` is 1 and 6.

`/etc/rcinit_level.d/S90omni`

A link to the `/etc/init.d/omni` script that starts up Data Protector.

Where `init_level` is 2,3,4, and 5.

During the installation, the following system files on the Cell Manager system are modified:

HP-UX:

`/etc/services`

The Data Protector port number for the service is added to the file.

`/opt/omni/sbin/crs`

The Data Protector CRS service is added.

When the installation is finished, the following processes are running on the Cell Manager:

`/opt/omni/sbin/crs`

The Data Protector Cell Request Server (CRS) service runs on the Cell Manager system and is started when the Cell Manager software is installed on the system. CRS starts and controls backup and restore sessions in the cell.

```
/opt/omni/sbin/rds
```

The Data Protector Raima Database Server (RDS) service runs on the Cell Manager system and is started when the Cell Manager software is installed on the system. RDS manages the IDB.

```
/opt/omni/sbin/mmd
```

The Data Protector Media Management Daemon (MMD) service runs on the Cell Manager and is started when the Cell Manager software is installed on the system. MMD manages the device and media management operations.

```
/opt/omni/java/server/bin/uiproxyd
```

The Data Protector Java GUI Server (UIProxy service) runs on the Cell Manager and is started when the Cell Manager software is installed on the system. The UIProxy service is responsible for communication between the Java GUI Client and the Cell Manager.

Setting environment variables

The installation procedure for the UNIX Cell Manager described earlier also installs the Data Protector user interface.

Before using the user interface (either the graphical user interface or the command-line interface), you should add the following to your environment variables:

```
/opt/omni/bin, /opt/omni/sbin and /opt/omni/sbin to the PATH variable
```

```
/opt/omni/lib/man to the MANPATH variable
```

```
/opt/omni/lib and /opt/omni/lib/arm to the LD_LIBRARY_PATH variable
```

Before attempting to use the graphical user interface, please ensure that the DISPLAY variable and locale are set correctly.

NOTE:

If you intend to use the Data Protector user interface to perform backups or restores across platforms, refer to the *HP Data Protector product announcements, software notes, and references* for the limitations incurred and online Help index: “customizing language settings” for information on how to customize language settings in the Data Protector GUI.

Allocating more disk space for the Cell Manager installation

You need a considerable amount of disk space to install the UNIX Cell Manager, in particular on the `/opt` directory and later on the `/var` directory where the database is stored (about 2% of the planned backup data). See the *HP Data Protector product announcements, software notes, and references* for details on the required disk space. If you do not have enough disk space, you can use linked directories, but you must create the links before the installation and ensure that the destination directories exist.

What's next?

At this stage, the Cell Manager is installed and – if it was selected – also the Installation Server for UNIX. Your next tasks are:

1. If you have not installed an Installation Server for UNIX on the same system, refer to “[Installing Installation Servers for UNIX](#)” on page 61.
2. Install an Installation Server for Windows, if you wish to remotely install software to Windows clients. Refer to “[Installing an Installation Server for Windows](#)” on page 65.
3. Distribute the software to clients. Refer to “[Installing Data Protector clients](#)” on page 69.

Installing a Windows Cell Manager

Prerequisites

To install a Windows Cell Manager, you must have `Administrator` rights. The Windows system that will become your Cell Manager must meet the following requirements:

- Have a supported Windows operating system installed. See the <http://www.hp.com/support/manuals> for details on supported operating systems for the Cell Manager.
- Have Microsoft Internet Explorer 5.0 or higher.
- Have sufficient disk space for the Data Protector Cell Manager software. Refer to the *HP Data Protector product announcements, software notes, and references* for details.
- Have sufficient disk space (about 2% of the backed up data) for the IDB. Refer to the *HP Data Protector product announcements, software notes, and references* for details.

- Have the port number 5555 (default) free. If this is not the case, refer to [“Changing the default port number”](#) on page 399.
- Have a static IP address for the system on which the Cell Manager will be installed. If the system is configured as a DHCP client, its IP address changes; therefore, it is required to either assign a permanent DNS entry for the system (and reconfigure it), or to configure a DHCP server to reserve a static IP address for the system (IP address is bound to the system's MAC address).
- Have the Microsoft implementation of the TCP/IP protocol installed and running. The protocol must be able to resolve hostnames. The computer name and the hostname must be the same. Refer to [“Setting up the TCP/IP protocol on Windows systems”](#) on page 392 for information on installation and configuration of the TCP/IP protocol.
- Have access to a DVD-ROM drive.
- Have the port number 5556 free to install Java GUI Server.
- For Java GUI Client, Java Runtime Environment (JRE) 1.5_06 or later minor version (for example, 1.5_07) is required.
- Ensure that network access user rights are set under the Windows local security policy for the account performing the installation.

Microsoft Terminal Services Client

- If you want to install Data Protector on Windows through Microsoft Terminal Services Client, ensure that the system you want to install Data Protector on has the **Terminal Server Mode** specified as **Remote Administration**:
 1. In the Windows Control Panel, click **Administrative Tools** and then **Terminal Services Configuration**.
 2. In the Terminal Services Configuration dialog box, click **Server Settings**. Ensure that the Terminal Services server is running in the Remote Administration mode.

Recommendation

- Check if you have Microsoft Installer (MSI) 2.0 prior to installing Data Protector A.06.10. If you have an older version of MSI, Data Protector setup will automatically upgrade it to version 2.0. In this case, Data Protector will display a note at the end of the upgrade, stating that MSI was upgraded. It is highly recommended to restart the system, if MSI was upgraded.
It is recommended that you upgrade your MSI to the version 2.0 before installing Data Protector A.06.10.

- If you expect DC binary files to grow larger than 2 GB (they are limited only by the file system settings), it is recommended to use the NTFS file system.

Cluster-aware Cell Manager

Additional prerequisites and steps are required for installing a cluster-aware Cell Manager. Refer to “[Installing a cluster-aware Cell Manager](#)” on page 191.

Installation procedure

To perform a new installation on a Windows system, follow these steps:

1. Insert the Windows installation DVD-ROM and run the following command to start the Data Protector Setup Wizard:

32-bit Windows (on x86 or AMD64/Intel EM64T):

```
\Windows_other\i386\setup.exe
```

64-bit Windows (on AMD64/Intel EM64T):

```
\Windows_other\x8664\setup.exe
```

On Windows Server 2008, the User Account Control dialog is displayed. Click **Continue** to proceed with the installation.

2. Follow the Setup Wizard and carefully read the license agreement. Click **Next** to continue, if you accept the terms of the agreement.

3. In the Installation Type page, select **Cell Manager** and then click **Next** to install Data Protector Cell Manager software.

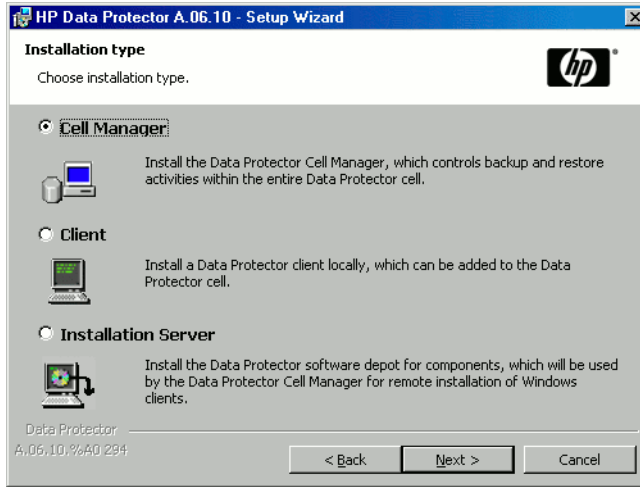

Figure 6 Selecting the installation type

4. Provide the username and password for the account under which the Data Protector services will run. Click **Next** to continue.
5. Click **Next** to install Data Protector in the default folder. Otherwise, click **Change** to open the Change Current Destination Folder window and enter a new path.

6. In the Component Selection page, select the components you want to install. For a list and descriptions of the Data Protector components, see “Data Protector components” on page 72.

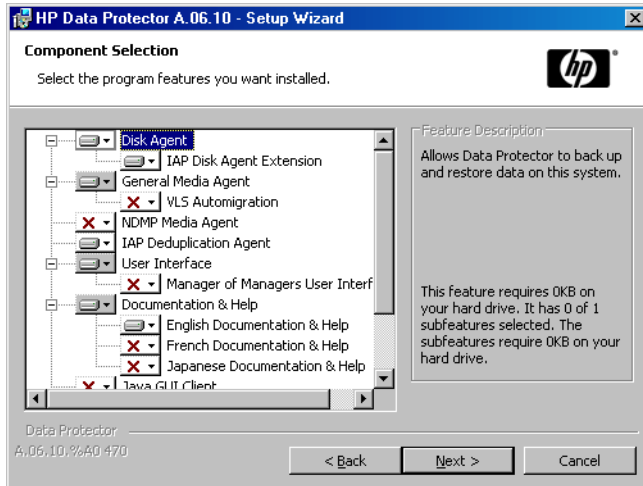

Figure 7 Selecting software components

Disk Agent, **General Media Agent**, **User Interface**, and **Installation Server** are selected by default. Click **Next**.

7. **Windows XP SP2, Windows Server 2003 SP2, and Windows Server 2008:** If Data Protector detects Windows Firewall on your system, the **Windows Firewall configuration** page is displayed. Data Protector setup will register all necessary Data Protector executables. By default, the selected option is **Initially, enable newly registered Data Protector binaries to open ports as needed**. If you do not want to enable Data Protector to open ports at the moment, deselect the option. However, note that for proper functioning of Data Protector, the executables must be enabled.

Click **Next**.

8. The component summary list is displayed. Click **Install** to start installing the selected components. This may take several minutes.

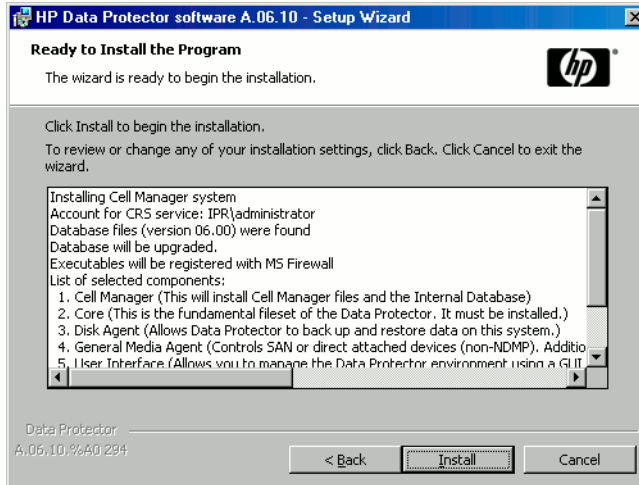

Figure 8 Component summary list

9. The **Installation status** page is displayed. Click **Next**.

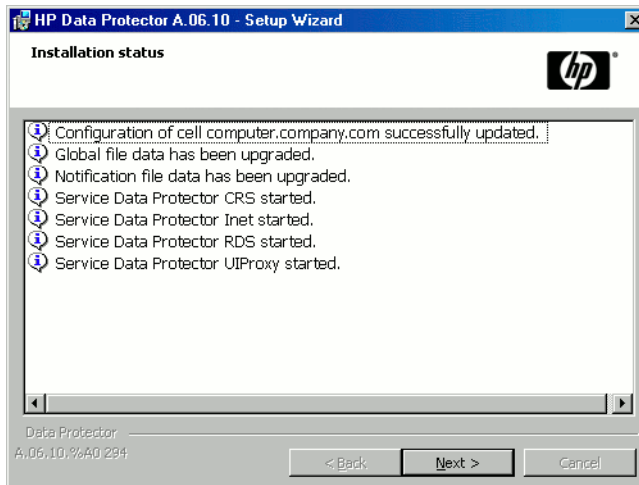

Figure 9 Installation status page

10. On operating systems other than 64-bit Windows (x64, IA-64), Windows Vista, and Windows Server 2008 TBD, the Setup Wizard enables you to install or upgrade the HP AutoPass utility if you want to download and install passwords for the purchased licenses directly through the internet from the HP password delivery center web server. For more information on the AutoPass utility, refer to [Obtaining and installing permanent passwords using the HP AutoPass utility](#) and the HP AutoPass online Help.

By default, the **Start AutoPass installation** or the **Upgrade AutoPass installation** option is selected. It is recommended to install the HP AutoPass utility. If you do not want to install or upgrade AutoPass, deselect the option.

On Windows x64, Windows Vista, and Windows Server 2008 operating systems, AutoPass is not installed.

To start using Data Protector immediately after setup, select **Start the Data Protector Manager**.

To view the *HP Data Protector product announcements, software notes, and references*, select **Open the Product Announcements**.

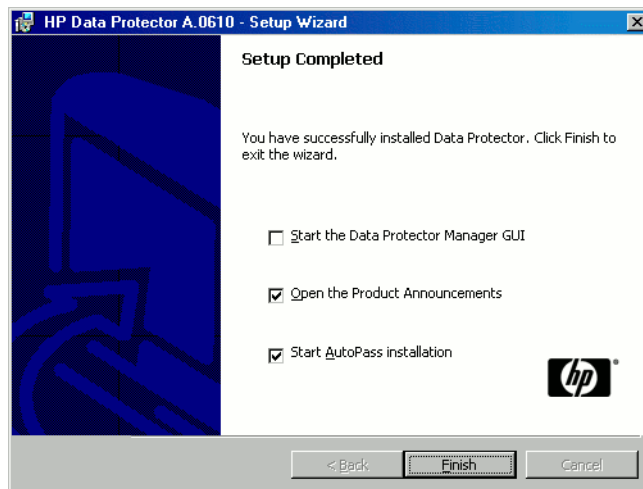

Figure 10 Selecting AutoPass for installation

Click **Finish**.

After the installation

Windows Server 2008: As soon as the setup is finished, the Cell Manager binary and configuration files are located in the `Data_Protector_home` and the

Data_Protector_program_data directories, respectively, whilst the software depot is located in the *Data_Protector_program_data\Depot* directory.

Other Windows operating systems: As soon as the setup is finished, the Cell Manager files are located in the *Data_Protector_home* directory, and the software depot is located in the *Data_Protector_home\Depot* directory.

When the installation is finished, the following processes will be running on the Cell Manager system:

<code>crs.exe</code>	The Data Protector Cell Request Server (CRS) service runs on the Cell Manager system and is started when the Cell Manager software is installed on the system. CRS starts and controls backup and restore sessions in the cell. It runs in the <i>Data_Protector_home\bin</i> directory.
<code>rds.exe</code>	The Data Protector Raima Database Server (RDS) service runs on the Cell Manager system and is started when the Cell Manager software is installed on the system. RDS manages the IDB. It runs in the <i>Data_Protector_home\bin</i> directory.
<code>omniinet.exe</code>	The Data Protector client service that enables the Cell Manager to start agents on other systems. The <code>Data_Protector_Inet</code> service must run on all systems in the Data Protector cell. It runs in the <i>Data_Protector_home\bin</i> directory.
<code>uiproxy.exe</code>	The Data Protector Java GUI Server (UIProxy service) runs on the Cell Manager system in the <i>Data_Protector_home\java\server\bin</i> directory. The UIProxy service is responsible for communication between the Java GUI Client and the Cell Manager.



NOTE:

If you intend to use the Data Protector user interface to perform backups or restores across platforms, refer to the *HP Data Protector product announcements, software notes, and references* for the limitations incurred.



TIP:

You can install additional code page conversion tables to correctly display filenames, if the appropriate encoding is not available from the Data Protector GUI. Refer to the operating system documentation for detailed steps.

Troubleshooting

In case of an unsuccessful setup, try to verify the requirements that are checked by `Setup` itself and what could have caused the failure if they had not been fulfilled. Refer to the [Prerequisites](#) on page 52.

This is the list of the requirements checked by `Setup`:

- Service Pack Version
- NSLookup, so that Data Protector is able to expand hostnames
- Disk Space
- Administrative Rights

What's next?

At this stage, the Cell Manager is installed and – if it was selected – also the Installation Server for Windows. Your next tasks are:

1. Install the Installation Server for UNIX, if you have a mixed backup environment. Refer to "[Installing Installation Servers](#)" on page 61. Skip this step if you do not need the Installation Server for UNIX.
2. Distribute the software to clients. Refer to "[Installing Data Protector clients](#)" on page 69.

Installing Installation Servers

Installation Servers can be installed on the Cell Manager system or any supported system that is connected to the Cell Manager by a LAN. See the <http://www.hp.com/support/manuals> for details on supported operating systems for the Installation Server.

To keep the Installation Servers on systems separate from the Cell Manager, install the corresponding software depot locally. The detailed procedure is described in this section.

Installing Installation Servers for UNIX

Prerequisites

The system that will become your Installation Server must meet the following requirements:

- Have the HP-UX, Solaris, or Linux operating system installed. For details on supported operating systems for the Installation Server, refer to the *HP Data Protector product announcements, software notes, and references*.
- Have the `inetd` daemon up and running.
- Have the port number 5555 (default) free. If this is not the case, refer to the “[Changing the default port number](#)” on page 399.
- Have the TCP/IP protocol installed and running. The protocol must be able to resolve hostnames.
- Have enough disk space for the complete Data Protector software depot. Refer to the *HP Data Protector product announcements, software notes, and references* for details.
- Have a DVD-ROM drive.
- The Cell Manager in the Data Protector cell must be of the A.06.10 version.



IMPORTANT:

To install Data Protector to linked directories, for instance:

```
/opt/omni/ -> /prefix/opt/omni/  
/etc/opt/omni/ -> /prefix/etc/opt/omni/  
/var/opt/omni/ -> /prefix/var/opt/omni/
```

Create the links before the installation and ensure that the destination directories exist.

 **NOTE:**

To install software from a device across the network, first mount the source directory on your computer.

Installation procedure

Follow these steps to install the Installation Server for UNIX on an HP-UX, Solaris, or Linux system:

1. Insert and mount the UNIX installation DVD-ROM to a mount point.

For example:

```
mkdir /dvdrom
mount /dev/dsk/c0t0d0 /dvdrom
```

Optionally, you can install Data Protector from a depot on the disk:

- To copy the `DP_DEPOT`, `AUTOPASS`, and `LOCAL_INSTALL` directories, where the installation files are stored, to your local disk, run:

```
mkdir directory
cp -r /dvdrom/platform_dir/DP_DEPOT directory
cp -r /dvdrom/platform_dir/AUTOPASS directory
cp -r /dvdrom/platform_dir/LOCAL_INSTALL directory
```

Where *platform_dir* is:

<code>hpux_ia</code>	HP-UX on IA-64 systems
<code>hpux_pa</code>	HP-UX on PA-RISC systems
<code>linux_x86_64</code>	Linux systems on AMD64/Intel EM64T
<code>solaris</code>	Solaris systems

- To copy the whole DVD-ROM to your local disk, run:

```
cp -r /dvdrom dvd_image_dir
```

2. Run the `omnisetup.sh` command.

To run this command from the DVD-ROM, type:

```
cd /dvdrom/LOCAL_INSTALL
./omnisetup.sh -IS
```

To start the installation from disk:

- If you have copied the `DP_DEPOT`, `AUTOPASS`, and `LOCAL_INSTALL` directories to your local disk to the *directory*, run:

```
cd directory/LOCAL_INSTALL
./omnisetup.sh -source directory -IS
```

- If you have copied the whole DVD-ROM to *dvd_image_dir*, run the `omnisetup.sh` command with the `-IS` parameter:

```
cd dvd_image_dir/LOCAL_INSTALL
./omnisetup.sh -IS
```

For a description of the `omnisetup.sh` command, refer to the `README` file located in the `Mount_point/` directory on the DVD-ROM or to the *HP Data Protector command line interface reference* located in the `Mount_point/DOCS/C/MAN` directory on the DVD-ROM.

When the installation is finished, the software depot for UNIX is located in the `/opt/omni/databases/vendor` directory.

The `omnisetup.sh` command installs the Installation Server with all packages. To install only a subset of the packages, use `swinstall` (for HP-UX), `pkgadd` (for Solaris) or `rpm` (for Linux). Refer to [“Installing on HP-UX, Solaris, and Linux systems using native tools”](#) on page 371.

IMPORTANT:

If you do not install the Installation Server for UNIX on your network, you will have to install every UNIX client locally from the UNIX installation DVD-ROM.

 **NOTE:**

If you install the User Interface component (either the graphical user interface or the command-line interface), update your environment variables before using it. Refer to [“Setting environment variables”](#) on page 51 for more information.

If you intend to use the Data Protector user interface to perform backups or restores across platforms, refer to the *HP Data Protector product announcements, software notes, and references* for the limitations incurred.

What’s next?

At this point, you should have the Installation Servers for UNIX installed on your network. Your next tasks are:

1. If you installed the Installation Server on a different system than the Cell Manager, you must manually add (import) the system to the Data Protector cell. Refer to [“Importing an installation server to a cell ”](#) on page 210.

 **NOTE:**

When an Installation Server is imported, the file `/etc/opt/omni/server/cell/installation_servers` on the Cell Manager is updated to list the installed push-packets. This can be used from the CLI to check the available push-packets. For this file to be kept up to date, you should export and re-import an Installation Server whenever push-packets are installed or deleted. This applies even if an Installation Server is installed on the same system as the Cell Manager.

2. If you have any Windows systems in your Data Protector cell, install the Installation Server for Windows. Refer to [“Installing an Installation Server for Windows”](#) on page 65.
3. Distribute the software to clients. Refer to [“Installing Data Protector clients”](#) on page 69.

Installing an Installation Server for Windows

Prerequisites

A Windows system that will become your future Installation Server must meet the following requirements:

- Have one of the supported Windows operating systems installed. See the <http://www.hp.com/support/manuals> for details on supported operating systems for the Installation Server.
- Have Microsoft Internet Explorer 5.0 or higher.
- Have enough disk space for the complete Data Protector software depot. Refer to the *HP Data Protector product announcements, software notes, and references* for details.
- Have access to a DVD-ROM drive.
- Have the Microsoft implementation of the TCP/IP protocol up and running. The protocol must be able to resolve hostnames. The computer name and the hostname must be the same. Refer to “[Setting up the TCP/IP protocol on Windows systems](#)” on page 392 for information on the installation and configuration of the TCP/IP protocol.

Limitation

Due to the security restrictions imposed by the Windows operating system, Installation Server can be used to remotely install clients only in the same domain.

Recommendation

Check if you have Microsoft Installer (MSI) 2.0 prior to installing Data Protector A.06.10. If you have an older version of MSI, Data Protector setup will automatically upgrade it to version 2.0. In this case, Data Protector will display a note at the end of the upgrade, stating that MSI was upgraded. It is highly recommended to restart the system, if MSI was upgraded. Consult Microsoft Support about the MSI 2.0 prerequisites for various Windows operating systems.

It is recommended that you upgrade your MSI to the version 2.0 before installing Data Protector A.06.10.

 **IMPORTANT:**

If you do not install the Installation Server for Windows on your network, you will have to install every Windows client locally from the DVD-ROM.

 **NOTE:**

You cannot remotely install a Data Protector client on the Windows system after an Installation Server has been installed on this system. To install an Installation Server and client component(s) on the same system, you must perform a local client installation. During the installation procedure, select all desired client components and the Installation Server component. Refer to “[Installing Windows clients](#)” on page 86.

Installation procedure

Follow these steps to install the Installation Server for Windows:

1. Insert the Windows installation DVD-ROM and run the following command to start the Data Protector Setup Wizard:

32-bit Windows (on x86 or AMD64/Intel EM64T):

```
\Windows_other\i386\setup.exe
```

64-bit Windows (on AMD64/Intel EM64T):

```
\Windows_other\x8664\setup.exe
```

On Windows Server 2008, the User Account Control dialog is displayed. Click **Continue** to proceed with the installation.

2. Follow the Setup Wizard and carefully read the license agreement. Click **Next** to continue, if you accept the terms of the agreement.

3. In the **Installation Type** page, select **Installation Server** and then click **Next** to install Data Protector software depot.

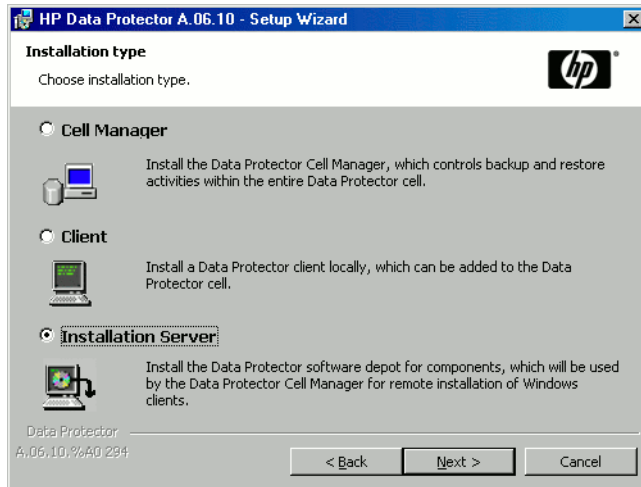

Figure 11 Selecting the installation type

4. Click **Next** to install Data Protector on the default folder.
Otherwise, click **Change** to open the Change Current Destination Folder window and enter a new path.
5. **Windows XP SP2, Windows Server 2003 SP1, and Windows Server 2008:** If Data Protector detects Windows Firewall on your system, the Windows Firewall configuration page is displayed. Data Protector setup will register all necessary Data Protector executables. By default, the selected option is *Initially, enable newly registered Data Protector binaries to open ports as needed*. If you do not want to enable Data Protector to open ports at the moment, deselect the option. However, note that for proper functioning of Data Protector, the executables must be enabled.
Click **Next**.

6. The component summary list is displayed. Click **Install** to start installing the selected components. This may take several minutes.

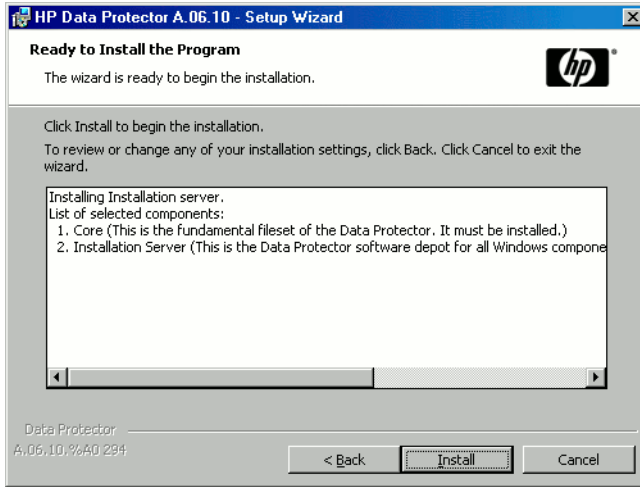

Figure 12 Component selection summary page

7. The Installation status page is displayed. Click **Next**.

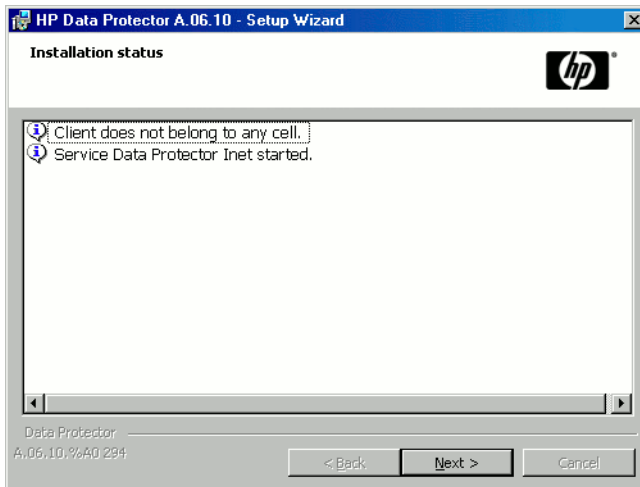

Figure 13 Installation status page

8. To view the *HP Data Protector product announcements, software notes, and references*, select **Open the Product Announcements**.

Click **Finish**.

As soon as the installation is finished, the software is, by default, installed in the *Data_Protector_program_data\Depot* directory on Windows Server 2008 systems, or the *Data_Protector_home\Depot* directory on other Windows operating systems. The software is shared so that it can be accessed from the network.

What's next?

At this point, you should have Installation Server for Windows installed on your network. Now you should perform the following tasks:

1. If you have set up an independent Installation Server (i.e. not on the Cell Manager) you must manually add (import) the system to the Data Protector cell. Refer to ["Importing an installation server to a cell"](#) on page 210.
2. Install an Installation Server for UNIX on HP-UX, Solaris, or Linux if you have a mixed backup environment. Refer to ["Installing Installation Servers for UNIX"](#) on page 61.
3. Distribute the software to clients. Refer to ["Installing Data Protector clients"](#) on page 69.

Installing Data Protector clients

You can install Data Protector clients *remotely*, by distributing them using the Installation Server, or *locally*, from the appropriate installation DVD-ROM.

For the list of Data Protector installation DVD-ROMs, refer to ["Data Protector installation DVD-ROMs"](#) on page 35.

After you have installed the Data Protector clients and eventually imported them into the Data Protector cell, it is highly recommended to verify the installation and to protect clients from unwarranted access. For procedure on verifying the client installation, refer to ["Verifying Data Protector client installation"](#) on page 341. For more information on security protection, refer to ["Security considerations"](#) on page 216.

["Installing Data Protector clients"](#) on page 69 lists Data Protector client systems with references to detailed descriptions.

Table 4 Installing Data Protector client systems

Client System	Installation Type & Reference
Windows	Remote and local installation; see "Installing Windows clients" on page 86.

Client System	Installation Type & Reference
HP-UX	Remote and local installation; see “Installing HP-UX clients” on page 93.
Solaris	Remote and local installation; see “Installing Solaris clients” on page 96.
Linux	Remote and local installation; see “Installing Linux clients” on page 103.
AIX	Remote and local installation; see “Installing AIX clients” on page 109.
Tru64	Remote and local installation; see “Installing Tru64 clients” on page 114.
Siemens Sinix	Remote and local installation; see “Installing Siemens Sinix clients” on page 112.
SCO	Remote and local installation; see “Installing SCO clients” on page 116.
DAS Client	Remote and local installation; see “Installing a Media Agent to use the ADIC/GRAU Library or the StorageTek Library” on page 118.
ACS Client	Remote and local installation; see “Installing a Media Agent to use the ADIC/GRAU Library or the StorageTek Library” on page 118.
Novell NetWare	Local installation; see “Local installation of the Novell NetWare clients” on page 128.
OpenVMS	Local installation; see “Local installation of OpenVMS clients” on page 135.
MPE/iX	Local installation; see “Installing MPE/iX clients” on page 142.
Other UNIX clients	Local installation; see “Local installation of UNIX clients” on page 146.

ZDB integrations

Data Protector ZDB integrations are software components that allow you to back up database applications with Data Protector. The systems running database applications are installed the same way as any Windows or UNIX client systems, provided that the appropriate software component has been selected (for example, MS Exchange Integration component for backing up the Microsoft Exchange Server database,

Oracle Integration component for backing up an Oracle database, and so on). Refer to [Table 5](#) on page 71 for the references.

Table 5 Installing integrations

Application	Reference
Microsoft Exchange Server	See " Microsoft Exchange Server clients " on page 154.
Microsoft SQL Server	See " Microsoft SQL Server clients " on page 155.
Microsoft SharePoint Portal Server	See " Microsoft SharePoint Portal Server Clients " on page 155.
Sybase	See " Sybase clients " on page 155.
Informix Server	See " Informix Server clients " on page 155.
SAP R/3	See " SAP R/3 clients " on page 156.
SAP DB	See " SAP DB clients " on page 156.
Oracle	See " Oracle clients " on page 157.
VMware Virtual Infrastructure	See " VMware Virtual Infrastructure clients " on page 157.
IBM DB2 UDB	See " DB2 clients " on page 158.
NNM	See " NNM clients " on page 158.
NDMP	See " NDMP clients " on page 158.
Microsoft Volume Shadow Copy Service	See " Microsoft Volume Shadow Copy Service clients " on page 159.
Lotus Domino Server	See " Lotus Notes/Domino Server clients " on page 159.
EMC Symmetrix	See " EMC Symmetrix integration " on page 159.
HP StorageWorks Disk Array XP	See " HP StorageWorks Disk Array XP integration " on page 164.

Application	Reference
HP StorageWorks Virtual Array	See “ HP StorageWorks Virtual Array integration ” on page 170.
HP StorageWorks Enterprise Virtual Array	See “ HP StorageWorks Enterprise Virtual Array integration ” on page 176.

Table 6 Other installations

Installation	Reference
Integrated Archive Platform (IAP)	See “ Installing the Data Protector IAP components ” on page 182.
Virtual Library System (VLS) automigration	See “ Installing the Data Protector VLS automigration components ” on page 183.
Localized User Interface	See “ Installing localized Data Protector user interface ” on page 184.
Web Reporting	See “ Installing Data Protector web reporting ” on page 189.
MC/ServiceGuard	See “ Installing Data Protector on MC/ServiceGuard ” on page 190.
Microsoft Cluster Server	See “ Installing Data Protector on Microsoft Cluster Server ” on page 191.
Veritas Cluster Server	See “ Installing Data Protector clients on a Veritas Cluster ” on page 202
Novell NetWare Cluster	See “ Installing Data Protector clients on a Novell NetWare Cluster ” on page 203

Data Protector components

For the latest information on the supported platforms, visit the HP Data Protector home page at <http://www.hp.com/support/manuals>.

These are the Data Protector components you can select and their descriptions:

User Interface

The User Interface component includes the Data Protector graphical user interface on Windows systems and the command-line interface on Windows and UNIX systems. The software is needed to access the Data Protector Cell Manager and must be installed at least on the system that is used for managing the cell.



NOTE:

If you intend to use the Data Protector user interface to perform backup or restores across platforms, refer to the *HP Data Protector product announcements, software notes, and references* for the limitations incurred.

Java GUI

The Data Protector Java GUI is a Java-based graphical user interface with a client-server architecture. The Java GUI Client will not be selected for installation by default; you have to select it manually. To install the command-line interface on a client with Java GUI, you also need to install the User Interface package to that system.

English Documentation & Help

This is the Data Protector English Language Documentation and online Help (OLH) file set.

French Documentation & Help

This is the Data Protector French Language Documentation and online Help (OLH) file set.

Japanese Documentation & Help

This is the Data Protector Japanese Language Documentation and online Help (OLH) file set.

Manager-of-Managers (MoM) User Interface

The Manager-of-Managers (MoM) User Interface includes the Data Protector graphical user interface on Windows. The software is needed to access the Data Protector Manager-of-Managers functionality and control the multi-cell environment. The Manager-of-Managers User Interface and the Manager User Interface are available as a common application.

On UNIX systems, the MoM User interface is available only as a part of the Java GUI.

Disk Agent	The Disk Agent component must be installed on systems that have disks that will be backed up with Data Protector.
IAP Disk Agent Extension	The IAP Disk Agent Extension component must be installed on systems that will perform backups directly to the IAP appliance using Data Protector.
General Media Agent	The General Media Agent component must be installed on systems that have backup devices connected or have access to a library robotics and will be managed by Data Protector.
Automatic Disaster Recovery	The Automatic Disaster Recovery component must be installed on systems for which you want to enable recovery using an automatic disaster recovery method; and on the system where the DR CD ISO image for Enhanced Disaster Recovery will be prepared to provide automatic preparation for the disaster recovery.
SAP R/3 Integration	The SAP R/3 Integration component must be installed on systems that have an SAP R/3 database that will be backed up with Data Protector.
SAP DB Integration	The SAP DB Integration component must be installed on systems that have an SAP DB database that will be backed up using Data Protector.
Oracle Integration	The Oracle Integration component must be installed on systems that have an Oracle database that will be backed up with Data Protector.
VMware Integration	The VMware Integration component must be installed on VirtualCenter systems (if they exist) and all the ESX Server systems that you plan to

back up with Data Protector. If you plan to use the consolidated backup methods, the integration component must be installed also on the backup proxy systems.

DB2 Integration	The DB2 Integration component must be installed on all systems that have a DB2 Server that will be backed up with Data Protector.
Sybase Integration	The Sybase Integration component must be installed on systems that have a Sybase database that will be backed up with Data Protector.
Informix Integration	The Informix Integration component must be installed on systems that have an Informix Server database that will be backed up with Data Protector.
MS Exchange Integration	The MS Exchange Integration component must be installed on Microsoft Exchange Server systems that will be backed up with Data Protector.
MS SQL Integration	The SQL Integration component must be installed on the systems that have an Microsoft SQL database which will be backed up with Data Protector.
MS SharePoint Portal Server Integration	The MS SharePoint Portal Server Integration component must be installed on Microsoft SharePoint Portal Server systems that will be backed up with Data Protector.
MS Volume Shadow Copy Integration	The MS Volume Shadow Copy Integration component must be installed on the Windows Server 2003 systems where you want to run backups coordinated by Volume Shadow Copy service.
EMC Symmetrix Agent	The EMC Symmetrix Agent component must be installed on the application and backup system to integrate EMC Symmetrix with Data Protector.

HP StorageWorks XP Agent	The HP StorageWorks XP Agent component must be installed on the application and backup system to integrate HP StorageWorks Disk Array XP with Data Protector.
HP StorageWorks VA Agent	The HP StorageWorks VA Agent component must be installed on the application and backup system to integrate HP StorageWorks Virtual Array with Data Protector.
HP StorageWorks EVA SMI-S Agent	The HP StorageWorks EVA SMI-S Agent component must be installed on the application and the backup system to integrate HP StorageWorks Enterprise Virtual Array with Data Protector.
HP OpenView NNM Backup Integration	The NNM Integration component must be installed on all systems in the cell that have an NNM database that will be backed up with Data Protector.
NDMP Media Agent	The NDMP Media Agent component must be installed on all systems that will be backing up data to NDMP dedicated drives through an NDMP server.
IAP Deduplication Agent	The IAP Deduplication Agent component must be installed on systems that will perform backups directly to the IAP appliance using Data Protector.
Lotus Integration	The Lotus Integration component must be installed on all systems in the Data Protector cell that have a Lotus Notes/Domino Server database that will be backed up with Data Protector.
VLS Automigration	The VLS Automigration component must be installed on clients that will perform Virtual Library System (VLS) smart media copying using Data Protector.

 **NOTE:**

You cannot install the General Media Agent and the NDMP Media Agent on the same system.

Remote installation of Data Protector clients

This section describes the procedure for distributing the Data Protector software to clients using the Installation Server (remote installation or upgrade).

Prerequisites

- For prerequisites and recommendations on the installation, refer to the section that describes the installation procedure for that particular client. The references are listed in [Table 4](#) on page 69 and in [Table 5](#) on page 71.
- See the <http://www.hp.com/support/manuals> and refer to the *HP Data Protector product announcements, software notes, and references* for the information on supported platforms, Data Protector components, and for disk space requirements.
- At this point, you should have the Cell Manager and the Installation Server(s) installed on your network.

 **NOTE:**

The Installation Server for Windows must reside in a shared directory so that it is visible throughout the network.

Distribute the software to clients using the Data Protector user interface. Cross-platform client installation is supported.

- To use secure shell installation, install and set up OpenSSH on the client and Installation Server. If your private key is encrypted, install and set up keychain on the Installation Server. See “[Remote installation using secure shell](#)” on page 83 for instructions.

 **NOTE:**

You cannot distribute software to clients in another Data Protector cell. However, if you have an independent Installation Server, you can import it into more than one cell. You can then distribute software within different cells by using the GUI connected to each Cell Manager in turn.

Adding clients to the cell

To distribute the Data Protector software to the clients that are not in the Data Protector cell yet, proceed as follows:

1. Start the Data Protector GUI:
 - Original Data Protector GUI:
 - On Windows: Select **Start > Programs > HP Data Protector > Data Protector Manager**.
 - On HP-UX or Solaris, run:
`/opt/omni/bin/xomni`
 - Data Protector Java GUI:
 - On Windows: Select **Start > Programs > HP Data Protector > Data Protector Java GUI Manager**.
In the Connect to a Cell Manager dialog, select or type the name of a Cell Manager and click `Connect`.
 - On UNIX, run:
`/opt/omni/java/client/bin/javadpgui.sh`

Refer to “[The Data Protector graphical user interface](#)” on page 39 and to the online Help for details on the Data Protector graphical user interface.

2. In the Data Protector Manager, switch to the **Clients** context.
3. In the Scoping Pane, right-click **Clients** and click **Add Clients**.
4. If you have more than one Installation Server configured, select the platform of the clients you want to install (UNIX or Windows) and the Installation Server to be used for installing the clients. Click **Next**.

5. Type the names of the clients or search for the clients (on Windows GUI only) you want to install as shown in [Figure 14](#) on page 79 and . Click **Next**.

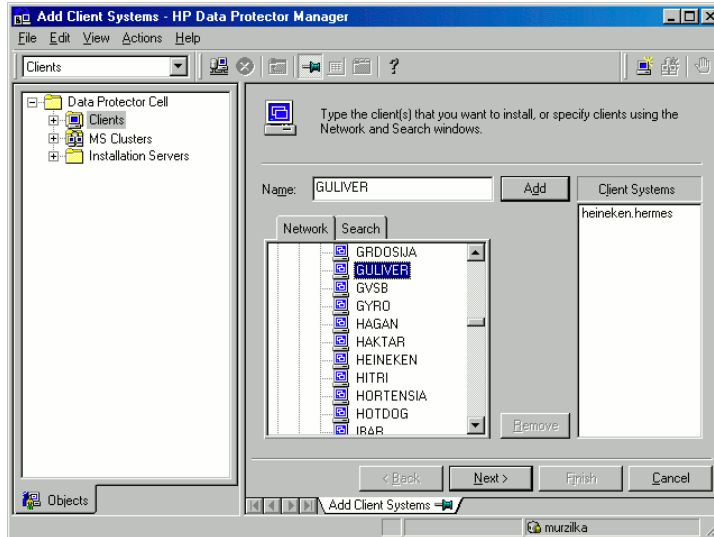

Figure 14 Selecting clients

6. Select the Data Protector components you want to install as shown in [Figure 15](#) on page 80 and . Note that you can select only one type of Media Agent. See “[Data Protector components](#)” on page 72.

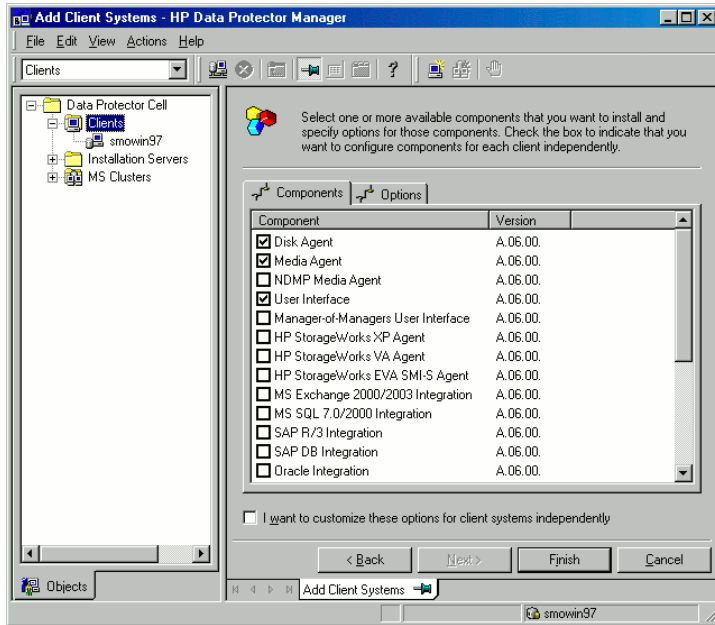

Figure 15 Selecting components

To change the default user account and target directory (on Windows only) for the installation, click **Options**.

If you selected more than one client and you would like to install different components on each client, click **I want to customize this option for client systems independently** and then click **Next**. Select the components you want to install for each client independently.

Click **Finish** to start the installation.

7. During the installation and when asked, provide the data required (username, password, and on Windows also domain) to access the specific client system and click **OK**.

As soon as a system has the Data Protector software installed and is added to the Data Protector cell, it becomes a Data Protector client.

 **NOTE:**

Before you start using the Data Protector GUI on the client system, add a user from that system to an appropriate Data Protector user group. For the procedure and the descriptions of available user rights, refer to the online Help.

Troubleshooting

When the remote installation is finished, you can restart any failed installation procedures using the GUI by clicking **Actions** and **Restart Failed Clients**. If the installation fails again, see [Chapter 6](#) on page 333.

Adding components to clients

You can install additional Data Protector software components on your existing clients and the Cell Manager. Components can be added remotely or locally. For local installation, see [“Changing Data Protector software components”](#) on page 245.

MC/ServiceGuard clients

In the MC/ServiceGuard cluster environment, make sure that the node to which you add the components is active.

Prerequisite

The corresponding Installation Server must be available.

To distribute the Data Protector software to clients in the Data Protector cell, proceed as follows:

1. In the Data Protector `Manager`, switch to the **Clients** context.
2. In the Scoping Pane, expand Clients, right-click a client, and then click **Add Components**.
3. If you have more than one Installation Server configured, select the platform of the clients on which you want to install the components (UNIX or Windows) and the Installation Server to be used for installing the components. Click **Next**.

4. Select the clients on which you want to install the components as shown in Figure 16 on page 82 and . Click **Next**.

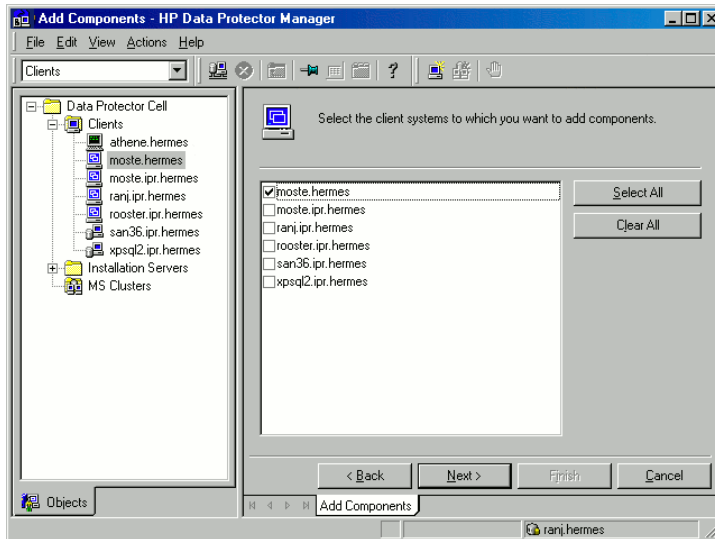

Figure 16 Selecting clients

5. Select the Data Protector components you want to install as shown in [Figure 17](#) on page 83. Note that you can select only one type of Media Agent. See “[Data Protector components](#)” on page 72.

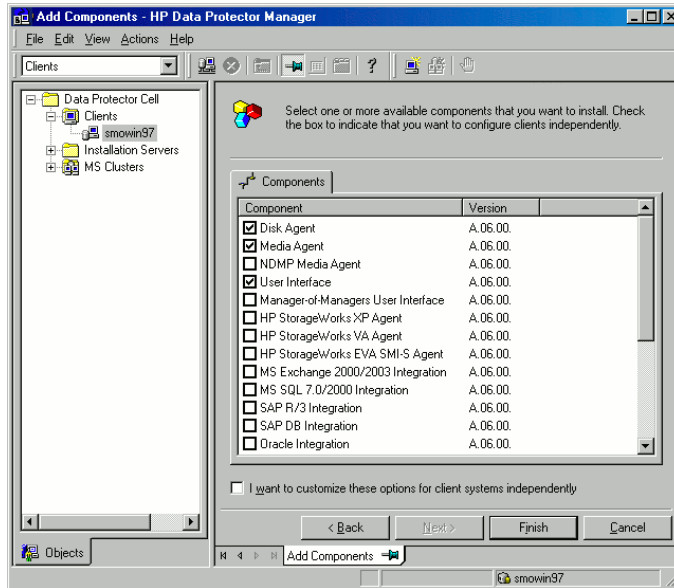

Figure 17 Selecting components

If you selected more than one client and you want to install different components on each client, click **I want to customize this option for client systems independently** and then click **Next**. Select the components for each client independently.

Click **Finish** to start the installation.

Remote installation using secure shell

Secure shell installation helps you protect your client and Installation Server by installing Data Protector components in a secure way. High level of protection is achieved by:

- Authenticating the Installation Server to the client in a secure way through the public-private key pair mechanism.
- Sending encrypted installation packages over the network.



NOTE:

Secure shell installation is supported on UNIX platforms only.

To use secure shell installation, install and set up OpenSSH on the client and Installation Server as described below.

Setting up OpenSSH

OpenSSH is an open source implementation of the secure shell protocol. To set up OpenSSH:

1. If `openssh` is not already installed on your system, download it from <http://www.openssh.org> and install it on both the Data Protector client and Installation Server. Alternately, on HP-UX, you can use HP-UX Secure Shell.

**NOTE:**

The default location for the secure shell installation is `/opt/ssh`.

2. On the Installation Server, run `ssh-keygen` to generate a public-private key pair. Keep the private key on the Installation Server while transferring the public key to the client. Note that if you use an encrypted private key (that is, protected by a passphrase), you need to set up keychain on the Installation Server (see [Setting up keychain](#) on page 86 for details).

For information on `ssh-keygen`, see <http://www.openbsd.org/cgi-bin/man.cgi?query=ssh-keygen&sektion=1>.

3. Store the public key in the `$HOME/.ssh` directory on the client under the name `authorized_keys`.

 **NOTE:**

`$HOME/.ssh` is usually the home directory of the `root` user.

To set an SSH protocol version (SSH1 or SSH2), modify the `protocol` parameter in the following files:

1. **On the Installation Server:**

```
ssh_install_directory/ssh/etc/ssh_config
```

This file will be used by the `ssh` command.

2. **On the client:**

```
ssh_install_directory/ssh/etc/sshd_config
```

This command will be used by the `ssh` daemon (`sshd`).

Note that these two files must be in sync.

 **NOTE:**

The default SSH protocol version is SSH2.

4. On the client, start the `ssh` daemon:

```
ssh_install_directory/ssh/sbin/sshd
```

5. Add the client to a list of known hosts (located in `$HOME/.ssh/known_hosts` on the Installation Server) by running:

```
ssh root@client_host
```

where `client_host` must be the fully qualified DNS name, for example:

```
ssh root@client1.company.com
```

6. On the Installation Server, set the `omnirc` variable `OB2_SSH_ENABLED` to 1. For more information on `omnirc` variables, see the *HP Data Protector troubleshooting guide*.

Setting up keychain

Keychain is a tool eliminating the need to manually supply a passphrase when decrypting the private key. It is needed only if the private key is encrypted. To set up keychain:

1. Download keychain from <http://www.gentoo.org/proj/en/keychain/index.xml> to the Installation Server.
2. Add the following two lines to `$HOME/.profile`:

HP-UX, Solaris:

```
keychain_install_directory/keychain-keychain_version/keychain
$HOME/.ssh/private_key

. $HOME/.keychain/'hostname'-sh
```

Linux:

```
/usr/bin/keychain $HOME/.ssh/private_key

. $HOME/.keychain/'hostname'-sh
```

3. On the Installation Server, set the `OB2_ENCRYPT_PVT_KEY omnirc` variable to 1. For more information on `omnirc` variables, see the *HP Data Protector troubleshooting guide*.

What's next?

After you set up OpenSSH and keychain, add clients to the cell using the GUI as described on [Adding clients to the cell](#) on page 78 or using the CLI by running the `ob2install` command. For information on CLI commands and their parameters, see the *HP Data Protector command line interface reference*.

NOTE:

If secure shell installation cannot be performed because the execution of its command fails, a warning is displayed. However, the installation continues using the standard Data Protector remote installation method.

Installing Windows clients

For details on supported platforms and components for a particular Windows operating system, see the <http://www.hp.com/support/manuals>.

Prerequisites

To install a Windows client, you must have the Administrator rights. The Windows system that will become your future Data Protector client system must meet the following requirements:

- Have Microsoft Internet Explorer 5.0 or higher.
- Have sufficient disk space for the Data Protector client software. Refer to the *HP Data Protector product announcements, software notes, and references* for details.
- Have port number 5555 (default) free.
- Have the Microsoft implementation of the TCP/IP protocol installed and running. The protocol must be able to resolve hostnames. The computer name and the hostname must be the same. Refer to [“Setting up the TCP/IP protocol on Windows systems”](#) on page 392 for information on installation and configuration of the TCP/IP protocol.
- For Java GUI Client, Java Runtime Environment (JRE) 1.5_06 or later minor version (for example, 1.5_07) is required.
- Ensure that network access user rights are set under the Windows local security policy for the account performing the installation.

Limitations

- Due to the security restrictions imposed by the Windows operating system, Installation Server can be used to remotely install clients only in the same domain.
- On Windows Me/XP HE, Data Protector clients can only be installed locally.

Recommendation

On each Windows client, check if you have Microsoft Installer (MSI) 2.0 prior to installing Data Protector A.06.10. If you have an older version of MSI, Data Protector setup will automatically upgrade it to version 2.0. In this case, Data Protector will display a note at the end of the upgrade, stating that MSI was upgraded. It is highly recommended to restart the client system, if MSI was upgraded. Consult Microsoft Support for Microsoft Installer 2.0 prerequisites on the various Windows operating systems.

If you start the Data Protector installation with an older version of the MSI, Data Protector setup will upgrade it to version 2.0. However, the system must be rebooted for the changes to take effect. After the computer is rebooted, restart the installation.

Automatic Disaster Recovery

The `Automatic Disaster Recovery` component must be installed on clients for which you want to enable recovery using an automatic disaster recovery method,

and on the system where the DR CD ISO image for Enhanced Disaster Recovery will be prepared.

Cluster-aware clients

Additional prerequisites are required for installing cluster-aware clients. Refer to “[Installing cluster-aware clients](#)” on page 199 for more details.

Before starting the installation procedure, decide which components you need to install on your client system. For the list of the Data Protector software components and their descriptions, see “[Data Protector components](#)” on page 72.

HP StorageWorks Disk Array XP hardware provider limitation

Data Protector and FRS require different versions of HP StorageWorks Disk Array XP hardware provider. However, only one version of the hardware provider can be installed on the same system. If you install the Data Protector and FRS on the same system that is connected to the HP StorageWorks Disk Array XP, you can use only one of these products.

Local installation

Windows clients can be installed locally, from the Windows installation DVD-ROM:

1. Insert the DVD-ROM and run:

32-bit Windows (on x86 or AMD64/Intel EM64T):

`\Windows_other\i386\setup.exe`

64-bit Windows (on AMD64/Intel EM64T):

`\Windows_other\x8664\setup.exe`

64-bit Windows (on Itanium): `\Windows_other\ia64\setup.exe`

2. In the **Installation Type** page, select **Client**. For Itanium clients, the type is selected automatically.

3. Enter the name of the Cell Manager. Refer to [Figure 18](#) on page 89.

If your Cell Manager uses a different port than the default 5555, change the port number. You can test if the Cell Manager is active and uses the selected port by clicking **Check response...**

Click **Next**.

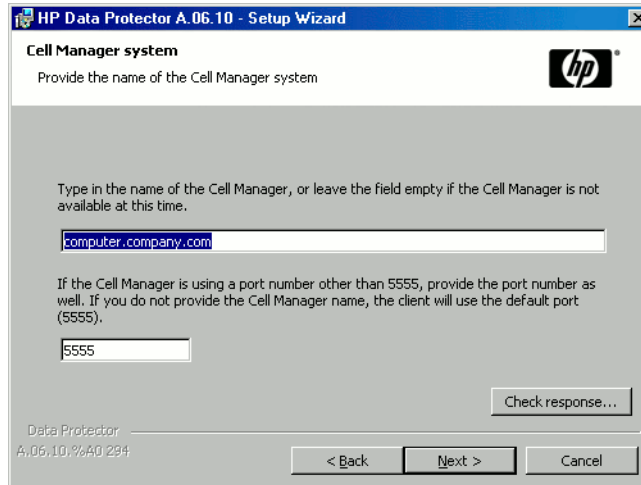

Figure 18 Choosing the Cell Manager

4. Click **Next** to install Data Protector on the default folder.

Otherwise, click **Change** to open the Change Current Destination Folder page and enter the path.

5. Select the Data Protector components that you want to install.

For information on other Data Protector components, refer to [“Data Protector components”](#) on page 72.

Click **Next**.

6. **Windows XP SP2, Windows 2003 SP2:** If Data Protector detects Windows Firewall on your system, the **Windows Firewall configuration** page is displayed. Data Protector setup will register all necessary Data Protector executables. By default, the selected option is **Initially, enable newly registered Data Protector binaries to open ports as needed**. If you do not want to enable Data Protector to open ports at the moment, deselect the option. However, note that for proper functioning of Data Protector, the executables must be enabled.

Click **Next**.

7. The component selection summary page is displayed. Click **Install** to install the selected components.

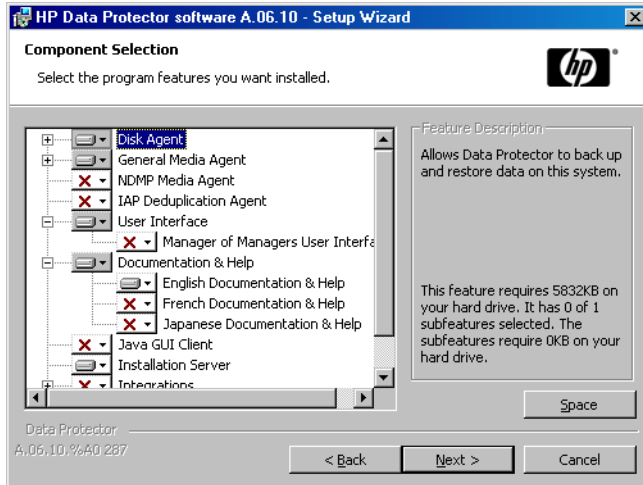

Figure 19 Component selection summary page

8. The Installation status page is displayed. Click **Next**.

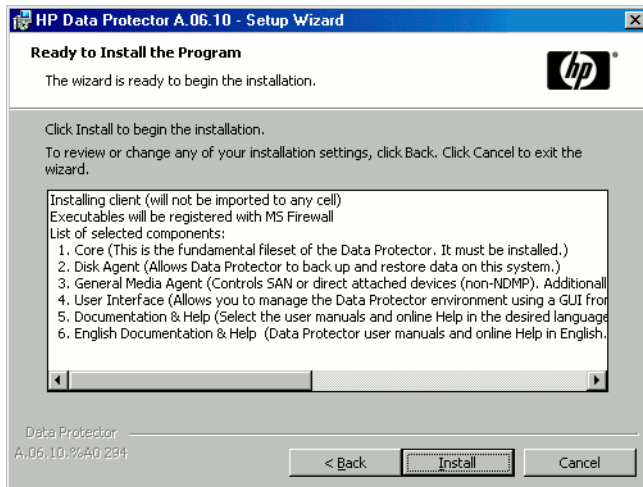

Figure 20 Installation summary page

9. To start using Data Protector immediately after setup, select **Launch Data Protector Manager**.

To view the *HP Data Protector product announcements, software notes, and references*, select **Open the Product Announcements**.

Click **Finish**.

Connecting a backup device to Windows systems

Once you have installed a Media Agent component, you can attach a backup device to a Windows system by performing the following steps:

1. Find the available SCSI addresses (referred to as *SCSI Target IDs* on Windows) for the drives and control device (robotics) of the backup device you want to connect. Refer to "[Finding unused SCSI target IDs on a Windows system](#)" on page 422.
2. Set unused SCSI Target IDs for the drives and control device (robotics). Depending on the device type, this can usually be done with switches on the device. For details, refer to the documentation that comes with the device.
Also see <http://www.hp.com/support/manuals> for information about supported devices.
3. Switch off your computer and connect your backup device to the system.
4. Switch on the device, then the computer, and wait until the boot process completes.

5. To verify that the system correctly recognizes your new backup device, in the `Data_Protector_home\bin` directory, run the `devbra -dev` command.

You should see a new device listed in the output of the command. For example, you might get the following output from the `devbra -dev` command:

- If the tape driver for your device is loaded:

```
HP:C1533A
tape3:0:4:0
DDS
...
```

The first line represents the device specification, the second one is the device filename.

The path format says that an HP DDS tape device has Drive instance number 3 and is connected to SCSI bus 0, SCSI Target ID 4, and LUN number 0.

- If the tape driver for your device is unloaded:

```
HP:C1533A
scsi1:0:4:0
DDS
...
```

The first line represents the device specification, the second one provides the device filename.

The path format says that an HP DDS tape device is connected to SCSI port 1, SCSI bus 0, and the tape drive has the SCSI Target ID 4, and LUN number 0.

For loading or unloading the native tape driver for your device, refer to [“Using tape and robotics drivers on Windows”](#) on page 403. For more information on creating a device filename, refer to [“Creating device files \(SCSI Addresses\) on Windows”](#) on page 407.

What's next?

At this stage, you should have client components installed and backup devices connected, so that you are able to configure backup devices and media pools. Refer to the online Help index: “configuring, backup devices” for information on configuration tasks.

Installing HP-UX clients

HP-UX clients can be installed locally from the UNIX installation DVD-ROM, or remotely using the Installation Server for UNIX.

Before starting the installation procedure, decide which components you need to install on your client system. For the list of the Data Protector software components and their descriptions, see [“Data Protector components”](#) on page 72.

Prerequisites

- For system requirements, disk space requirements, supported platforms, processors, and Data Protector components, refer to the *HP Data Protector product announcements, software notes, and references*.
- At this point, you should have the Cell Manager and Installation Server for UNIX installed on your network. If not, see [“Installing the Data Protector Cell Manager \(CM\) and Installation Server\(s\) \(IS\)”](#) on page 42 for instructions.
- You will need either *root* access or an account with *root* capabilities.
- For Java GUI Client, Java Runtime Environment (JRE) 1.5_06 or later minor version (for example, 1.5_07) is required.

Local installation

If you do not have an Installation Server for UNIX installed in your environment, you have to perform local installation from the UNIX installation DVD-ROM. See [“Local installation of UNIX clients”](#) on page 146 for instructions.

After the local installation, the client system has to be manually imported into the cell. See also [“Importing clients to a cell ”](#) on page 207.

Remote installation

You install the client software from the Installation Server for UNIX to clients using the Data Protector graphical user interface. For the step-by-step procedure for remotely installing the software, refer to [“Remote installation of Data Protector clients”](#) on page 77.

After the remote installation, the client system automatically becomes a member of the Data Protector cell.

If you have installed a Media Agent on your client, you must physically connect the backup device to the system. To see if the device drivers, appropriate for the type of

your device, are already build in the kernel, check your kernel configuration before running a backup.

Cluster-aware clients

Additional prerequisites and steps are required for installing cluster-aware clients. Refer to “[Installing a cluster-aware client](#)” on page 191 for more details.

Checking the kernel configuration on HP-UX

The following procedure explains how to check and build your kernel configuration on the HP-UX 11.x, using the *HP System Administration Manager (SAM)* utility. Refer to “[SCSI robotics configuration on HP-UX](#)” on page 408 for instructions on how to build the kernel manually.

Follow this procedure to build the kernel configuration using the *HP System Administration Manager (SAM)* utility:

1. Log in as a `root` user, open the terminal and type `sam`.
2. In the **System Administration Manager** window, double-click **Kernel Configuration**, and then **Drivers**.

3. In the **Kernel Configuration** window, verify the following:

- The drivers for the devices you will be using must be listed among the installed drivers. See [Figure 21](#) on page 95. If the driver you are looking for is not listed, you have to install it using the `/usr/sbin/swinstall` utility. For example:
 - A Tape Device Driver is required for tape devices and must be installed if you have connected a tape device to the system. For example, for generic SCSI tape drives, like DLT or LTO, the `stape` driver is used, and for DDS devices the `tape2` driver.
 - A SCSI Pass-Through driver named `set1` or `spt`, or an autochanger robotics driver named `schgr` (depending on the hardware) is required to control robotics in Tape library devices.Refer to “[SCSI robotics configuration on HP-UX](#)” on page 408 for details.

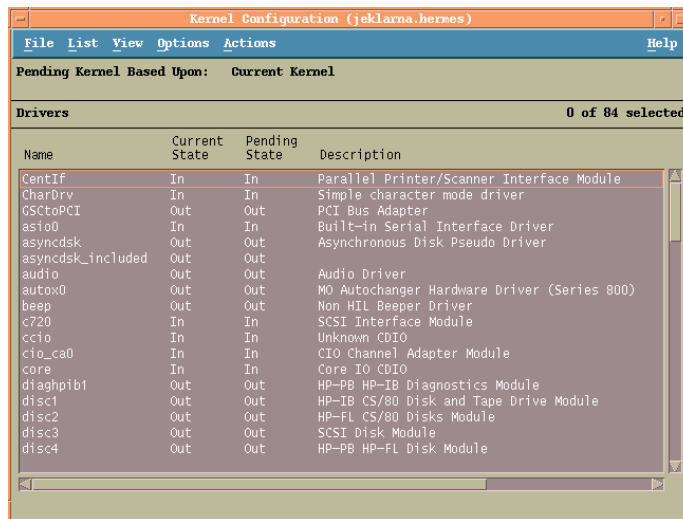

Figure 21 Kernel configuration Window

- The status of a driver that is displayed in the **Current State** column must be set to **In**. If the status value is set to **Out**, proceed as follows:
 1. Select the driver in the list. Click **Actions** and select **Add Driver to Kernel**. In the **Pending State** column, the status will be set to **In**.
Repeat this for each driver for which the **Current State** is **In**.
 2. Click **Actions** and select **Create a New Kernel** to apply the changes, that is to build a **Pending Kernel** into the **Current Kernel**. The action requires a restart of the system.

Once you have all the required drivers built in the kernel, you can continue by connecting a backup device to your system.

Connecting a backup device to HP-UX systems

1. Determine the available SCSI addresses for the drives and control device (robotics). Use the `/usr/sbin/ioscan -f` system command.

Refer to “[Finding the unused SCSI addresses on HP-UX](#)” on page 415 for more information.
2. Set the SCSI address on the device. Depending on the device type, this can be usually done with switches on the device. For details, refer to the documentation that comes with the device.

Refer to <http://www.hp.com/support/manuals> for details about supported devices.
3. Connect the device to the system, switch on the device, and then the computer, and wait until the boot process completes. The device files are usually created during the boot process.
4. Verify that the system correctly recognizes your new backup device. Use the `ioscan` utility:

```
/usr/sbin/ioscan -fn
```

so that you can see the device files listed for each connected backup device. If the device file has not been created automatically during the boot process you must create it manually. Refer to “[Creating device files on HP-UX](#)” on page 412.

Once the installation procedure has been completed and the backup devices have been properly connected to the system, refer to the online Help index: “configuring, backup devices” for detailed information about configuring devices and media pools or other Data Protector configuration tasks.

Installing Solaris clients

Solaris clients can be installed locally from the UNIX installation DVD-ROM, or remotely using the Installation Server for UNIX.

Before starting the installation procedure, decide which components you need to install on your client system. For the list of the Data Protector software components and their descriptions, see “[Data Protector components](#)” on page 72.

Prerequisites

- For system requirements, disk space requirements, supported platforms, and Data Protector components, refer to the *HP Data Protector product announcements, software notes, and references*.
- At this point, you should have the Cell Manager and Installation Server for UNIX already installed on your network. Refer to [“Installing the Data Protector Cell Manager \(CM\) and Installation Server\(s\) \(IS\)”](#) on page 42 for instructions.
- To install a Solaris client, you will need either *root* access or an account with *root* capabilities.
- For Java GUI Client, Java Runtime Environment (JRE) 1.5_06 or later minor version (for example, 1.5_07) is required.

Local installation

If you do not have an Installation Server for UNIX installed in your environment, you have to perform local installation from the UNIX installation DVD-ROM. Refer to [“Local installation of UNIX clients”](#) on page 146 for instructions.

Remote installation

You install the client software from the Installation Server for UNIX to clients using the Data Protector graphical user interface. For the step-by-step procedure for remotely installing the software, refer to [“Remote installation of Data Protector clients”](#) on page 77.



NOTE:

If you install the `User Interface` component (which includes the graphical user interface and the command-line interface), you should update your environment variables before using it. Refer to [“Setting environment variables”](#) on page 51 for more information. If you install the User Interface on a Solaris 2.6 client, only the command-line interface is available.

As soon as the client components have been installed, the target system automatically becomes a member of the Data Protector cell.

 **IMPORTANT:**

If you want to install Data Protector to linked directories, for instance:

```
/opt/omni/ -> /prefix/opt/omni/
```

```
/etc/opt/omni/ -> /prefix/etc/opt/omni/
```

```
/var/opt/omni/ -> /prefix/var/opt/omni/
```

you must create the links before the installation and ensure that the destination directories exist.

Cluster-aware clients

Additional prerequisites are required for installing cluster-aware clients. Refer to “Installing a Client” on page 202 for more details.

Post-installation configuration

Configuration files

Once you have a Media Agent component installed on the client system, you have to check your configuration files (`/kernel/drv/st.conf`), depending on the device type you will be using.

- For Exabyte devices (8 mm), no changes to the `/kernel/drv/st.conf` file are necessary.
- For an HP DAT (4 mm) device, add the following lines to your `/kernel/drv/st.conf` file:

```
tape-config-list =  
  
"HP      HP35470A", "HP DDS 4mm DAT", "HP-data1",  
"HP      HP35480A", "HP DDS-DC 4mm DAT", "HP-data1",  
"HP      C1533A", "HP DDS2 4mm DAT", "HP-data2",  
"HP      C1537A", "HP DDS3 4mm DAT", "HP-data3",  
"HP      C1553A", "HP DDS2 4mm DATloader", "HP-data2",  
"HP      C1557A", "HP DDS3 4mm DATloader", "HP-data3";  
HP-data1 = 1,0x34,0,0x8019,3,0x00,0x13,0x03,2;  
HP-data2 = 1,0x34,0,0x8239,4,0x0,0x13,0x24,0x3,3;  
HP-data3 = 1,0x34,0,0x8239,4,0x0,0x13,0x24,0x3,3;
```

 **IMPORTANT:**

These HP data entries differ from the default entries that are usually suggested by HP Support. Specify these lines exactly, or Data Protector will not be able to use your drive.

- For DLT, DLT1, SuperDLT, LTO1, LTO2 and STK9840 devices, add the following lines to the `/kernel/drv/st.conf` file:

```
tape-config-list =

"HP      Ultrium 1-SCSI", "HP Ultrium 1-SCSI", "LTO-data",
"HP      Ultrium 2-SCSI", "HP_LTO",      "HP-LTO2",
"DEC DLT2000", "Digital DLT2000", "DLT2k-data",
"Quantum DLT4000", "Quantum DLT4000", "DLT4k-data",
"QUANTUM DLT7000", "Quantum DLT7000", "DLT7k-data",
"QUANTUM DLT8000", "Quantum DLT8000", "DLT8k-data",
"HP C9264CB-VS80", "HP DLT vs80 DLTloader", "HP_data1"
"QUANTUM SuperDLT1", "QUANTUM SuperDLT", "SDLT-data",
"TANDBERGSuperDLT1", "TANDBERG SuperDLT", "SDL-data",
"STK      9840", "STK 9840",      "CLASS_9840";

DLT2k-data = 1,0x38,0,0x8639,4,0x17,0x18,0x80,0x81,3;
DLT4k-data = 1,0x38,0,0x8639,4,0x17,0x18,0x80,0x81,3;
DLT7k-data = 1,0x38,0,0x8639,4,0x82,0x83,0x84,0x85,3;
DLT8k-data = 1,0x77,0,0x1d639,4,0x84,0x85,0x88,0x89,3;
HP_data1 = 1,0x3a,0,0x8639,4,0x40,0x86,0x87,0x7f,0;
LTO-data = 1,0x7a,0,0x1d679,4,0x00,0x00,0x00,0x40,3;
HP-LTO2 = 1,0x7a,0,0xd639,4,0x00,0x00,0x00,0x42,3;
SDLT-data = 1,0x79,0,0x8639,4,0x90,0x91,0x90,0x91,3;
CLASS_9840 = 1,0x78,0,0x1d679,1,0x00,0;
```

- For an HP StorageWorks 12000e (48AL) autoloader (HP C1553A), add the following entries in addition to HP data entries in your `/kernel/drv/st.conf` file:

```
name="st" class="scsi"
target=ID lun=0;
name="st" class="scsi"
target=ID lun=1;
```

Replace the `ID` symbol with the autoloader's SCSI address and set the autoloader option number to 5 (the switch is located on the device's rear panel) and the drive's DIP switch setting to 11111001 (the switches are accessible from the bottom side of the autoloader).

 **NOTE:**

The HP StorageWorks 12000e library does not have a dedicated SCSI ID for the picker device but accepts both data drive access commands and picker commands through the same SCSI ID. However, the data drive access commands must be directed to SCSI lun=0 and the picker commands to SCSI lun=1.

For all other devices, check the `st.conf.template` template (located in `/opt/omni/spt`) for required entries in the `st.conf` file. This is only a template file and is not meant as a replacement for the `st.conf` file.

- For the SCSI Exchanger devices on Solaris using the SCSI Pass-Through driver, you have to install the SCSI Pass-Through driver first, then you install the SCSI device.

Install the SCSI Pass-Through driver using the following steps:

1. Copy the `sst` module into the `/usr/kernel/drv/sparcv9` directory and the `sst.conf` configuration file into the `/usr/kernel/drv` directory:

32-bit Solaris:

```
$cp /opt/omni/spt/sst /usr/kernel/drv/sst
```

```
$cp /opt/omni/spt/sst.conf /usr/kernel/drv/sst.conf
```

64-bit Solaris:

```
$cp /opt/omni/spt/sst.64bit /usr/kernel/drv/sparcv9 /sst
```

```
$cp /opt/omni/spt/sst.conf /usr/kernel/drv/sst.conf
```

2. Add the following line to the `/etc/devlink.tab` file:

 **IMPORTANT:**

When editing the `/etc/devlink.tab` file, do not use [space] characters. Use only [TAB] characters.

```
"type=ddi_pseudo;name=sst;minor=character rsst\A1"
```

This will cause devlinks (1M) to create link(s) to devices with names of the `/dev/rsstX` form, where X is the SCSI target number.

3. Install the driver on the system by entering the following command:

```
add_drv sst
```

4. At this stage, you are ready to install the SCSI device. Before the installation, you must assign the correct SCSI address to each drive and the robotics (picker) of the exchanger device. The chosen addresses must not be used by any other device of the system.

To check the SCSI configuration, shut down the system by the following command:

```
shutdown -i0
```

then run the `probe-scsi-all` command at the `ok` prompt to check the assigned addresses:

```
ok probe-scsi-all
```

When you have finished, restart the system with:

```
ok boot -r
```

To install the SCSI device, follow the steps:

- a. Edit `/kernel/drv/st.conf` to set up the device's drive parameters in order to use the assigned SCSI ports (refer to the appropriate device's documentation).

The following example will show the setup of the ADIC-VLS DLT device with the SCSI port 5 assigned to the SCSI tape drive and the SCSI port 4 assigned to the ADIC SCSI control device (picker):

Example

```
tape-config-list = "DEC      DLT2000", "ADIC DLTDLib", "ADIC2000-data";
ADIC2000-data = 1,0x38,0,0x8639,4,0x17,0x18,0x80,0x81,3;name="st" class=
target=5 lun=0;
name="st" class= "scsi"
target=4 lun=0;
```

The data displayed in the example above must be in the

`/kernel/drv/st.conf` file.

- b. Edit `/usr/kernel/drv/sst.conf` to set up the ADIC SCSI control device in order to use the assigned SCSI port 4. Add the following data for the ADIC drive to the `/usr/kernel/drv/sst.conf` file:

```
name="sst" class= "scsi"
target=4 lun=0;
```

When you have modified the `/kernel/drv/st.conf` file and the `/usr/kernel/drv/sst.conf` file, you are ready to physically connect a backup device to your system.

Connecting a backup device to a Solaris system

Follow the procedure below to connect a backup device to a Solaris system:

1. Create a reconfigure file:

```
touch /reconfigure
```

2. Shut down the system by entering the `$shutdown -i0` command, and then switch off your computer and physically connect the device to the SCSI bus. Check that no other device is using the same SCSI address you have selected for the device.

See <http://www.hp.com/support/manuals> for details about supported devices.

 **NOTE:**

Data Protector does not automatically recognize cleaning tapes on a Solaris system. If Data Protector detects and inserts a cleaning tape in the StorageWorks 12000e (48AL) device, the tape driver enters an undefined state and may require you to reboot your system. Load a cleaning tape manually, when Data Protector issues a request for it.

3. Switch your computer back on and interrupt the boot process by pressing the `Stop-A` key. Verify that the new device is recognized correctly by entering the `probe-scsi-all` command at the `ok` prompt:

```
ok > probe-scsi-all
```

Then, enter:

```
ok > go
```

to continue.

4. The device should work properly at this stage. The device files must be located in the `/dev/rmt` directory for the drives and in the `/dev` directory for the SCSI control device (picker).

 **NOTE:**

On Solaris systems, (especially in case of Solaris 64-bit), links to the SCSI control device (picker) are not always created automatically. In this case, create symbolic links. For example:

```
ln -s /devices/pci@1f,4000/scsi@3,1/sst@4,1:character /dev/rsst4
```

You can use the Data Protector `uma` utility to verify the device. To check the picker of the SCSI Exchanger device from the previous example (using the SCSI port 4), enter:

```
echo "inq" | /opt/omni/sbin/uma -ioctl /dev/rsst4
```

The picker must identify itself as a SCSI-2 device library. The library can be checked by forcing it to initialize itself. The command is:

```
echo "init" | /opt/omni/sbin/uma -ioctl /dev/rsst4
```

Make sure you use Berkeley-style device files, in this case, `/dev/rmt/0hb` (not `/dev/rmt/0h`) for the exchanger drive and `/dev/rsst4` for the SCSI control device (picker).

What's next?

Once the installation procedure has been completed and the backup devices are properly connected to the Solaris client, refer to the online Help index: "configuring, backup devices" for more information about configuring backup devices, media pools, or other configuration tasks.

Installing Linux clients

Linux client systems can be installed locally by using the UNIX installation DVD-ROM, or remotely using the Installation Server for UNIX.

Before starting the installation procedure, decide which components you need to install on your client system. For the list of the Data Protector software components and their descriptions, see "[Data Protector components](#)" on page 72.

Prerequisites

- For system requirements, disk space requirements, supported platforms, and Data Protector components, refer to the *HP Data Protector product announcements, software notes, and references*.
- At this point, you should have the Cell Manager and Installation Server for UNIX already installed on your network. See [“Installing the Data Protector Cell Manager \(CM\) and Installation Server\(s\) \(IS\)”](#) on page 42 for instructions.
- The `rpm` utility must be installed and set up. Other packaging systems (like `deb`) are not supported.
- For Java GUI Client, Java Runtime Environment (JRE) 1.5_06 or later minor version (for example, 1.5_07) is required.



NOTE:

On Cell Manager platforms where the original Data Protector GUI is not supported, you can use the Data Protector Java GUI or install the original Data Protector GUI on a system where it is supported. Use the `omniusers` command to create a remote user account on the new Cell Manager. You can then use this user account on any system with the Data Protector GUI installed to start the GUI and connect to the new Cell Manager. Refer to the `omniusers` man page.



NOTE:

Data Protector uses the default port number 5555. Therefore, this particular port number should not be used by another program. Some versions of Linux use this number for other purposes.

If the port number 5555 is already in use, you should make it available for Data Protector or you can change the default port number to an unused port number. See [“Changing the default port number”](#) on page 399.

HP ServiceGuard cluster

With HP ServiceGuard clusters, the Data Protector agents (Disk agent, Media Agent) must be installed separately *on each cluster node* (local disk) and not on the shared disk.

After the installation, you need to import the *virtual host* (application package) to the cell as a client. Therefore the application package (for example Oracle) must run on

the cluster with its *virtual IP*. Use the command `cmviewcl -v` to check this before importing the client.

Novell Open Enterprise Server (OES)

On Novell OES systems, Data Protector automatically installs the OES aware Disk Agent. However, there are some Novell OES specific aspects:

- If you install Novell OES on 32-bit SUSE Linux Enterprise Server 9.0 (SLES), after installing a Data Protector Linux client on a system, you have to upgrade the Data Protector client as well.

Note that the new Novell OES aware Disk Agent will be pushed on the client system during the upgrade.

- If you remove the Novell OES component from SLES, you have to reinstall the Data Protector client.

Local installation

If you do not have an Installation Server for UNIX installed in your environment, you have to perform local installation from the UNIX installation DVD-ROM. See “[Local installation of UNIX clients](#)” on page 146 for instructions.

Remote installation

You remotely install a Linux client system by distributing the Data Protector components from the Installation Server for UNIX to the Linux system, using the Data Protector graphical user interface. For the step-by-step procedure for distributing the software, refer to “[Remote installation of Data Protector clients](#)” on page 77.

As soon as the client components have been installed, the target system automatically becomes a member of the Data Protector cell.

Troubleshooting

If you run into problems with remote installation on a Linux client system, ensure that the `root` account has rights to access the system either by using `exec` or `shell` services. To achieve this, do the following:

1. Edit the `/etc/xinetd.conf`. Find the definitions for `exec` and `shell` services and add the following line to the definition of these two services:

```
server_args = -h
```

For example:

```
service shell
{
  socket_type = stream
  protocol = tcp
  wait = no
  user = root
  server = /usr/sbin/in.rshd
  server_args = -L -h
}
service exec
{
  socket_type = stream
  protocol = tcp
  wait = no
  user = root
  server = /usr/sbin/in.rexecd
  server_args = -h
}
```



NOTE:

Some Linux distributions have these services configured in separate files in the `/etc/xinetd.d` directory. In this case, locate the appropriate file (`/etc/xinetd.d/rexec` and `/etc/xinetd.d/rsh`) and modify it as described above.

2. Kill the `inetd` process with the `HUP` signal:

```
kill -HUP $(ps ax|grep inet|grep -v grep|cut -c1-6)
```
3. Create a `~root/.rhosts` file with the entry: `my_installation_server root` That will allow administration access from the Installation Server.

After you have installed Data Protector, you can remove the entry from the `~root/.rhosts` file, and the `-h` flag from the `/etc/xinetd.conf` (`/etc/inetd.conf` for Red Hat Enterprise Linux) file. Then repeat the `kill` command from the step [Step 2](#) on page 106.

For more information, see the `rexecd(8)`, `rexec(3)`, `rshd(8)`, `rsh(1)` or `pam(8)` man pages. If this fails, refer to [“Local installation of UNIX clients”](#) on page 146.

Kernel configuration

The following procedure explains how to check and build your kernel configuration:

- 1.** Log in as a root user, then in the `/usr/src/linux` directory run the `make menuconfig` command.
- 2.** Select `SCSI Support` and press `Enter`. Then select the following options: `SCSI support`, `SCSI tape support`, `SCSI generic support` and optionally `Probe all LUNS on each SCSI device`.

If the items are already included in kernel, exit without saving changes. You can continue by connecting a backup device to your system. Refer to [“Connecting a backup device to the Linux system”](#) on page 108.

- 3.** If you made changes, save the configuration and do the following:
 - a.** Run the `make dep` command.

This command builds the tree of dependencies in the kernel sources. These dependencies could be affected by the options you chose when configuring the kernel.
 - b.** Run the `make clean` command to purge files left from previous builds of the kernel.
 - c.** Run the `make bzImage` command. After it is completed, run the `make modules` command.

4. To install the kernel to the `/boot` directory on an Intel-based system, copy the new `bzImage` to the `/boot` directory as follows:
 - a. Run the following command: `cp /usr/src/linux/arch/i386/boot/bzImage/boot/newkernel`
 - b. Run the `make modules_install` command to install the modules in the `/lib/modules` directory.
 - c. Edit `/etc/lilo.conf` and add the following:

```
image = /boot/newkernel
label = new
read-only
```
 - d. Run the `/sbin/lilo` command to update LILO.

At the next reboot, select the kernel 'new' in LILO and to load the new kernel. If everything is working correctly, move the kernel 'new' to the first position in the `lilo.conf` file so it will boot every time by default.

More information about kernel and SCSI configuration can be found in kernel source directory `/usr/src/linux/Documentation/`.

Connecting a backup device to the Linux system

Once you have a Media Agent component installed on the Linux client, follow the steps below to connect a backup device to the system:

1. Run the `cat /proc/scsi/scsi` command to determine the available SCSI addresses for the drives and control device (robotics).
2. Set the SCSI address on the device. Depending on the device type, this can be done by switching on the device. For details, refer to the documentation that comes with the device.

Refer to <http://www.hp.com/support/manuals> for details about supported devices.

3. Connect the device to the system, switch on the device, then switch on the computer, and wait until the boot process completes. The device files are created during the boot process. (On RedHat Linux, an application, Kudzu, is launched during the boot process when a new device is connected to the system. Press any key to start the application, and then click the `Configure` button).

4. To verify if the system correctly recognizes your new backup device, run `cat /proc/scsi/scsi` and then `dmesg |grep scsi`. The device files are listed for each connected backup device.

Examples

For robotics, the output of the `dmesg |grep scsi` command is:

```
Detected scsi generic sg2 at scsi2, channel 0, id 4, lun 0, type 8
```

and for drives:

```
Detected scsi tape st0 at scsi2, channel 0, id 5, lun 0
```

5. Device files are created in the `/dev` directory. To check if the links to the device files were created, run:

```
ll /dev | grep device_file
```

For example:

```
ll /dev | grep sg2
```

The output of this command is:

```
lrwxrwxrwx 1 root root 3 Nov 27 2001 sg2 -> sgc
```

where `/dev/sg2` is a link to the device file `/dev/sgc`. This means that the device files to be used by Data Protector are `/dev/sgc` for robotics and `/dev/st0` for drive. Device files for robotics are `sga`, `sgb`, `sgc`,... `sgh`, and for the drives `st0`, `st1`, ... `st7`.

What's next?

Once the installation procedure has been completed and the backup devices have been properly connected to the Linux client system, refer to the online Help index: "configuring, backup devices" for information about configuring backup devices and media pools, or other configuration tasks.

Installing AIX clients

AIX clients can be installed locally from the UNIX installation DVD-ROM, or remotely using the Installation Server for UNIX.

Before starting the installation procedure, decide which components you need to install on your client system. For the list of the Data Protector software components and their descriptions, see [“Data Protector components”](#) on page 72.

Prerequisites

- For system requirements, disk space requirements, supported platforms, and Data Protector components, refer to the *HP Data Protector product announcements, software notes, and references*.
- At this point, you should have the Cell Manager and Installation Server for UNIX already installed on your network. Refer to [“Installing the Data Protector Cell Manager \(CM\) and Installation Server\(s\) \(IS\)”](#) on page 42 for instructions.
- For Java GUI Client, Java Runtime Environment (JRE) 1.5_06 or later minor version (for example, 1.5_07) is required.



IMPORTANT:

Before installing the `Disk Agent` component on an AIX system, check that the `portmapper` is up and running. In the `/etc/rc.tcpip` file, there must be the line that starts the `portmapper`:

```
start /usr/sbin/portmap "$src_running"
```

The `src_running` flag is set to 1 if the `srcmstr` daemon is running. The `srcmstr` daemon is the System Resource Controller (SRC). The `srcmstr` daemon spawns and controls subsystems, handles short subsystem status requests, passes requests on to a subsystem, and handles error notification.

Local installation

If you do not have an Installation Server for UNIX installed in your environment, you have to perform local installation from the UNIX installation DVD-ROM. See [“Local installation of UNIX clients”](#) on page 146 and for instructions.

Remote installation

You install the AIX client software from the Installation Server for UNIX to clients using the Data Protector graphical user interface. For the step-by-step procedure for remotely installing the software, refer to [“Remote installation of Data Protector clients”](#) on page 77.

As soon as the client components have been installed, the target system automatically becomes a member of the Data Protector cell.

Connecting a backup device to an AIX client

Once you have a Media Agent component installed on an AIX client, proceed as follows:

1. Shut down the computer and connect your backup device to the SCSI bus. Check that no other device is using the same SCSI address which has been selected for your backup device.

See <http://www.hp.com/support/manuals> for details about supported devices.

2. Switch on the computer and wait until the boot process completes. Start the AIX system `smit` management tool and verify that the system correctly recognizes your new backup device.

 **IMPORTANT:**

Use `smit` to change the device's default block size to 0 (variable block size).

3. Select the appropriate device files from the `/dev` directory and configure your Data Protector backup device.

 **IMPORTANT:**

Use only non-rewind-style device files. For example, select `/dev/rmt0.1` instead of `/dev/rmt0`.

What's next?

Once the installation procedure has been completed and your backup devices have been properly connected to the AIX system, refer to the online Help index: "configuring, backup devices" for information on configuring backup devices, media pools, or on other Data Protector configuration tasks.

Installing Siemens Sinix clients

Siemens Sinix clients can be installed locally by using the UNIX installation DVD-ROM, or remotely using the Installation Server for UNIX.

Before starting the installation procedure, decide which components you need to install on your client system. For the list of the Data Protector software components and their descriptions, see [“Data Protector components”](#) on page 72.

Prerequisites

- For system requirements, disk space requirements, supported platforms, and Data Protector components, refer to the *HP Data Protector product announcements, software notes, and references*.
- At this point, you should have the Cell Manager and Installation Server for UNIX already installed on your network. See [“Installing the Data Protector Cell Manager \(CM\) and Installation Server\(s\) \(IS\)”](#) on page 42 for instructions.
- For Java GUI Client, Java Runtime Environment (JRE) 1.5_06 or later minor version (for example, 1.5_07) is required.

Local installation

If you do not have an Installation Server for UNIX installed in your environment, you have to perform local installation from the UNIX installation DVD-ROM. See [“Local installation of UNIX clients”](#) on page 146 for instructions.

Remote installation

You install the Sinix client software from the Installation Server for UNIX to clients using the Data Protector graphical user interface. For the step-by-step procedure for remotely installing the software, refer to [“Remote installation of Data Protector clients”](#) on page 77.

As soon as the client components have been installed, the target system automatically becomes a member of the Data Protector cell.

Connecting a backup device to Siemens Sinix system

Once you have a Media Agent component installed on Siemens Sinix client system, follow the steps below to connect a backup device to the system:

1. Shut down your computer, and then connect your backup device to the SCSI bus.

See <http://www.hp.com/support/manuals> for details about supported devices and the documentation that comes with the device.

Check that no other device is using the same SCSI address as the one selected for your backup device.

2. Switch your computer back on and wait until the boot process is completed.
3. Select the appropriate device file name from the `/dev` directory.

You can obtain the list of devices with the `autoconf -l` command. Use the tape device (for example, `ios0/stape006`) that was reported in the output of this command to get the special device filename that Data Protector can use (for example, `/dev/ios0/rstape006nv`).

 **NOTE:**

The special device files are located in the `/dev` directory, so you must add the `/dev` path in front of the device name.

Since Data Protector can use only a character device, the letter `r` is added in front of the `stape006`.

Data Protector can handle a tape device if it is opened as non-rewindable and with variable block size; therefore you must add letters `n` and `v` as suffixes.

The `/dev/ios0/rstape006nv` device filename is explained in [Figure 22](#) on page 114.

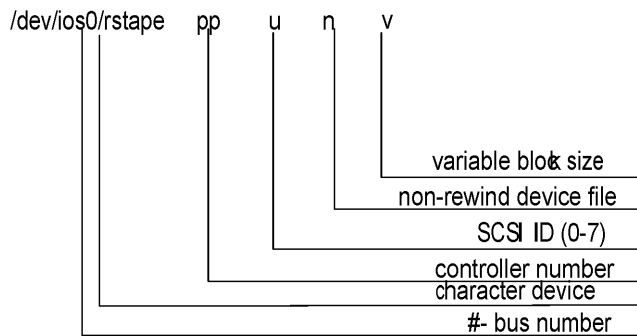

Figure 22 Format of a device filename:

What's next?

Once the installation procedure has been completed and the backup devices have been properly connected to the Siemens Sinix client system, refer to the online Help index: "configuring, backup devices" for information about configuring backup devices and media pools, or other configuration tasks.

Installing Tru64 clients

Tru64 clients can be installed locally by using UNIX installation DVD-ROM, or remotely using the Installation Server for UNIX.

Before starting the installation procedure, decide which components you need to install on your client system. For the list of the Data Protector software components and their descriptions, see "[Data Protector components](#)" on page 72.

Prerequisites

- For system requirements, disk space requirements, supported platforms, and Data Protector components, refer to the *HP Data Protector product announcements, software notes, and references*.
- At this point, you should have the Cell Manager and Installation Server for UNIX already installed on your network. See "[Installing the Data Protector Cell Manager \(CM\) and Installation Server\(s\) \(IS\)](#)" on page 42 for instructions.
- For Java GUI Client, Java Runtime Environment (JRE) 1.5_06 or later minor version (for example, 1.5_07) is required.

Local installation

If you do not have an Installation Server for UNIX installed in your environment, you have to perform local installation from the UNIX installation DVD-ROM. See “[Local installation of UNIX clients](#)” on page 146 for instructions.

Remote installation

You install the Tru64 client software from the Installation Server for UNIX to clients using the Data Protector graphical user interface. For the step-by-step procedure for remotely installing the software, refer to “[Remote installation of Data Protector clients](#)” on page 77.

As soon as the client components have been installed, the target system automatically becomes a member of the Data Protector cell.

Tru64 Cluster

You must have `root` permissions on every target system.

Data Protector has to be installed locally or remotely on the shared disk of the Tru64 Cluster. Use one of the cluster nodes to perform an installation.

After the installation, the cluster virtual hostname and individual nodes have to be imported to the Data Protector cell. For a detailed procedure, see “[Importing a cluster-aware client to a cell](#)” on page 210.

Connecting a backup device to Tru64 client

Once you have a Media Agent component installed on an Tru64 client, proceed as follows:

1. Shut down the computer and connect your backup device to the SCSI bus.

 **NOTE:**

It is not recommended to connect the backup device on the same SCSI bus as the hard disk drive.

Check that no other device is using the same SCSI address which has been selected for your backup device.

See <http://www.hp.com/support/manuals> for details about supported devices.

2. Switch on the computer and wait until the boot process completes. Verify that the system correctly recognizes your new backup device.

What's next?

Once the installation procedure has been completed and your backup devices have been properly connected to the Tru64 system, refer to the online Help index: “configuring, backup devices” for information on configuring backup devices, media pools, or on other Data Protector configuration tasks.

Installing SCO clients

SCO clients can be installed locally by using the UNIX installation DVD-ROM, or remotely using the Installation Server for UNIX.

Note that for the UnixWare, remote installation is not available.

Before starting the installation procedure, decide which components you need to install on your client system. For the list of the Data Protector software components and their descriptions, see “[Data Protector components](#)” on page 72.

Prerequisites

- For system requirements, disk space requirements, supported platforms, and Data Protector components, refer to the *HP Data Protector product announcements, software notes, and references*.
- At this point, you should have the Cell Manager and Installation Server for UNIX already installed on your network. See “[Installing the Data Protector Cell Manager \(CM\) and Installation Server\(s\) \(IS\)](#)” on page 42 for instructions.
- For Java GUI Client, Java Runtime Environment (JRE) 1.5_06 or later minor version (for example, 1.5_07) is required.

Local installation

If you do not have an Installation Server for UNIX installed in your environment, you have to perform local installation from the UNIX installation DVD-ROM. See “[Local installation of UNIX clients](#)” on page 146 for instructions.

Remote installation

You install the SCO client software from the Installation Server for UNIX to clients using the Data Protector graphical user interface. For the step-by-step procedure for remotely installing the software, refer to “[Remote installation of Data Protector clients](#)” on page 77.

As soon as the client components have been installed, the target system automatically becomes a member of the Data Protector cell.

Connecting a backup device to an SCO system

Once you have a Media Agent component installed on the SCO client system, follow the steps below to connect a backup device to the system:

1. Find out which SCSI addresses are still free by checking the `/etc/conf/cf.d/m SCSI` file. This file shows the currently connected SCSI devices.
See <http://www.hp.com/support/manuals/> for details about supported devices and the documentation that comes with the device.
2. Shut down your computer, and then connect your backup device to the SCSI bus.
3. Restart your computer.
4. Configure your device using the `mkdev tape` command. In the list of tape drive types, select the Generic SCSI-1 / SCSI-2 tape drive.

NOTE:

Remember the UNIT ID, which is displayed when you run the `mkdev tape` command. You will need it in order to recognize the device filename.

5. After you have configured the device and restarted the system, check in the `/etc/conf/cf.d/m SCSI` file if your device was connected properly.
6. Select the appropriate device filename from the `/dev` directory.
Use the `nrStp#` name, where # stands for UNIT ID of the device. The UNIT ID of the device is defined in the step [Step 4](#) on page 117. The `/dev/nrStp#` device filename is explained in [Figure 23](#) on page 118.

CAUTION:

Use only non-rewind-style device files with a variable block size. Verify whether the block size is variable by using the `tape -s getblk /dev/nrStp#` command. The value for a variable block size should be 0. If the value is not 0, use the `tape -a 0 setblk /dev/nrStp#` command to set the value of the block size to 0.

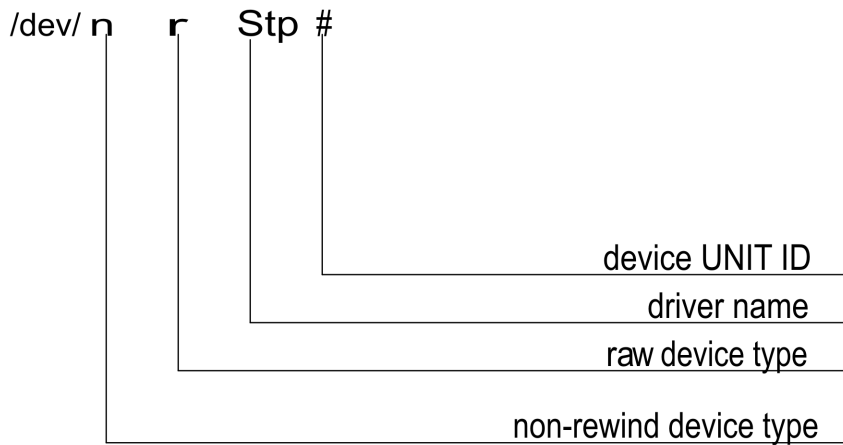

Figure 23 Format of a device filename

What's next?

Once the installation procedure has been completed and the backup devices have been properly connected to the SCO client system, refer to the online Help index: "configuring, backup devices" for information about configuring backup devices and media pools or other configuration tasks.

Installing a Media Agent to use the ADIC/GRAU Library or the StorageTek Library

Data Protector provides a dedicated ADIC/GRAU and StorageTek ACS library policies used to configure an ADIC/GRAU library or StorageTek ACS library as a Data Protector backup device. You need to install a Data Protector Media Agent (the General Media Agent or the NDMP Media Agent) on every system that will be physically connected to a drive in an ADIC/GRAU or StorageTek library. Also, for multihost configurations, you must install a Data Protector Media Agent on the systems that control the ADIC/GRAU or StorageTek library robotics. Note that multihost configuration is a configuration where the library and drive are not connected to the same computer.

For the ADIC/GRAU library, each system on which you install a Media Agent software and it accesses the library robotics through the GRAU/ADIC DAS Server is called a **DAS Client**. For the STK ACS integration, each system on which you install a Media Agent software and it accesses the library robotics through the STK ACS Server is called an **ACS Client**.

 **NOTE:**

You need special licenses that depend on the number of drives and slots used in the StorageTek library. See [Chapter 5](#) on page 309 for more information.

Connecting library drives

Physically connect the library drives to the systems where you intend to install a Media Agent software.

See <http://www.hp.com/support/manuals> for details about supported ADIC/GRAU or STK libraries.

See “[Installing HP-UX clients](#)” on page 93 for information about how to physically attach a backup device to the system. Also see the documentation that comes with the ADIC/GRAU or StorageTek library.

See “[Installing Windows clients](#)” on page 86 for information on how to physically attach a backup device to a supported Windows system. Also see the documentation that comes with the ADIC/GRAU or StorageTek library.

Preparing Data Protector clients to use the ADIC/GRAU Library

The following steps pertain to configuring an ADIC/GRAU library, and should be completed before you install a Media Agent software:

1. If the DAS server is based on OS/2, before you configure a Data Protector ADIC/GRAU backup device, create/update the `C:\DAS\ETC\CONFIG` file on the DAS server computer. In this file, a list of all DAS clients must be defined. For Data Protector, this means that each Data Protector client that can control the library robotics must be defined in the file.

Each DAS client is identified with a unique client name (no spaces), for example `DP_C1`. For example, the contents of the `C:\DAS\ETC\CONFIG` file should look like this:

```
client client_name = DP_C1,  
#         hostname = AMU,"client1"  
ip_address = 19.18.17.15,  
requests = complete,  
options = (avc,dismount),  
volumes = ((ALL)),  
drives = ((ALL)),  
inserts = ((ALL)),  
ejects = ((ALL)),  
scratchpools = ((ALL))
```

2. On each Data Protector client with a Data Protector Media Agent installed that needs to access ADIC/GRAU DAS library robotics, edit the `omnirc` file (`Data_Protector_home\omnirc` file on Windows, `/opt/omni/.omnirc` file on HP-UX and Solaris or `/usr/omni/omnirc` file on AIX) and set the following variables:

<code>DAS_CLIENT</code>	A unique GRAU client name defined on the DAS server. For example, if the name of the client is "DP_C1", the appropriate line in the <code>omnirc</code> file is <code>DAS_CLIENT=DP_C1</code> .
<code>DAS_SERVER</code>	The name of the DAS server.

3. You must find out how your ADIC/GRAU library slot allocation policy has been configured, either statically or dynamically. Refer to the *AMU Reference Manual* for information on how to check what type of allocation policy is used.

The static policy has a designated slot for each volser, while the dynamic allocation policy assigns the slots randomly. Depending on the policy that has been set, you need to configure Data Protector accordingly.

If the static allocation policy has been configured, you need to add the following `omnirc` variable to your system controlling the robotics of the library:

```
OB2_ACIEJECTTOTAL = 0
```

 **NOTE:**

This applies to HP-UX and Windows.

For further questions on the configuration of your ADIC/GRAU library, please contact your local ADIC/GRAU support or review your ADIC/GRAU documentation.

Installing a Media Agent to use the ADIC/GRAU Library

Prerequisites

The following prerequisites for installation must be met before installing a Media Agent on a system:

- The ADIC/GRAU library must be configured and running. See the documentation that comes with the ADIC/GRAU library.
- Data Protector must be installed and configured. See [“Installing the Data Protector Cell Manager \(CM\) and Installation Server\(s\) \(IS\)”](#) on page 42 in this chapter.
- DAS server must be up and running.

To control the ADIC/GRAU library, the DAS software is required. Every DAS client must have DAS client software installed. Each media- and device-related action initiated by Data Protector first goes from the DAS client to the DAS server. Then, it is passed to the internal part (AMU - AML Management Unit) of the ADIC/GRAU library which controls the robotics and moves or loads media. After a completed action, the DAS server replies to the DAS client. See the documentation that comes with the ADIC/GRAU library.

- The following information must be obtained before you install a Media Agent:

- The hostname of the DAS Server (an application that runs on an OS/2 host).
- The list of available drives with the corresponding DAS name of the drive. The obtained drive names are to be used when configuring the ADIC/GRAU drives in Data Protector.

If you have defined the DAS clients for your ADIC/GRAU system, you can get this list with one of the following `dasadmin` commands:

```
dasadmin listd2 client
```

```
dasadmin listd client
```

where *client* is the DAS client for which the reserved drives are to be displayed.

The `dasadmin` command can be called from the `C:\DAS\BIN` directory on the OS/2 host, or, if installed on other systems, from the directory where the DAS client software has been installed. On a UNIX client system, this directory is usually the `/usr/local/aci/bin` system directory.

- The list of available Insert/Eject Areas, with corresponding format specifications.

You can get the list of available Insert/Eject Areas in the Graphical Configuration of AMS (AML Management Software) on an OS/2 host:

1. Start this configuration from the menu `Admin > Configuration`.
2. Open the **EIF-Configuration** window by double-clicking the **I/O unit** icon, and then click the **Logical Ranges** field. In the text box, the available Insert/Eject Areas are listed.



NOTE:

One Data Protector library device can handle only one media type. It is important to remember which media type belongs to each one of the specified Insert and Eject Areas, because you will need this data later for configuring Insert/Eject Areas for the Data Protector library.

- A list of UNIX device files for the drives, if you want to install a Media Agent on a UNIX system.

Run the `ioscan -fn` system command on your system to display the required information.

For more information on UNIX device files, see

["Connecting a backup device to HP-UX systems"](#) on page 96.

- A list of SCSI addresses for the drives, if you want to install a Media Agent on a Windows system. For example, `scsi4:0:1:0`.
For more information on SCSI addresses, see [“Connecting a backup device to Windows systems”](#) on page 91.

Installation

The installation procedure consists of the following steps:

1. Distribute a Media Agent component to clients, using the Data Protector graphical user interface and Installation Server. See [“Remote installation of Data Protector clients”](#) on page 77 in this chapter.

2. Install the ADIC/GRAU library:

- On a Windows system, do the following:
 - a. Copy the `aci.dll`, `winrpc32.dll` and `ezrpc32.dll` libraries to the `Data_Protector_home\bin` directory. (These three libraries are part of the DAS client software shipped with the ADIC/GRAU library. They can be found either on the installation media or in the `C:\DAS\AMU\` directory on the AMU-PC.)
 - b. Copy these three files to the `%SystemRoot%\system32` directory as well.
 - c. Copy `Portinst` and `Portmapper` service to the DAS client. (These requirements are part of the DAS client software shipped with the ADIC/GRAU library. They can be found on the installation media.)
 - d. In the Control Panel, go to Administrative Tools, Services and start `portinst` to install `portmapper`. The DAS client needs to be restarted to run the `portmapper` service.
 - e. After rebooting the system, check if `portmapper` and both `rpc` services are running (in the Control Panel, go to **Administrative Tools, Services** and check the status of the services.
- On an HP-UX system, copy the `libaci.sl` shared library into the `/opt/omni/lib` directory. You must have permissions to access this directory. Make sure that the shared library has read and execute permissions for everyone (root, group and others). The `libaci.sl` shared library is part of the DAS client software shipped with the ADIC/GRAU library. It can be found on the installation media.
- On an AIX system, copy the `libaci.o` shared library into the `/usr/omni/lib` directory. You must have permissions to access this directory. Make sure that the shared library has read and execute permissions for everyone (root, group and others). The `libaci.o` shared library is part of the DAS client software shipped with the ADIC/GRAU library. It can be found on the installation media.

At this stage, you should have your hardware connected and your DAS software properly installed.

Run the following command to check whether the library drives are properly connected to your system:

- **On Windows:** `Data_Protector_home\bin\devbra -dev`
- **On HP-UX:** `/opt/omni/lbin/devbra -dev`
- **On AIX:** `/usr/omni/bin/devbra -dev`

You should see the library drives with corresponding device files displayed in the list.

What's next?

Once a Media Agent is installed and the ADIC/GRAU library is physically connected to the system, refer to the online Help index: "configuring, backup devices" for information about additional configuration tasks, such as configuring backup devices and media pools.

Preparing Data Protector clients to use the StorageTek Library

The following prerequisites for installation must be met before installing a Media Agent:

- The StorageTek library must be configured and running. See the documentation that comes with the StorageTek library.
- Data Protector must be installed and configured. See ["Installing the Data Protector Cell Manager \(CM\) and Installation Server\(s\) \(IS\)"](#) on page 42.
- The following information must be obtained before you start installing a Media Agent software:

- The *hostname* of the host where ACSLS is running.
- A list of ACS drive IDs that you want to use with Data Protector. The obtained drive IDs are to be used when configuring the StorageTek drives in Data Protector. To display the list, log in on the host where ACSLS is running and execute the following command:

```
rlogin "ACSLS hostname" -l acssa
```

You will have to enter the terminal type and wait for the command prompt. At the ACSSA prompt, enter the following command:

```
ACSSA> query drive all
```

The format specification of an ACS drive must be the following:

```
ACS DRIVE: ID: #, #, #, # - (ACS num, LSM num, PANEL, DRIVE)
```

- A list of available ACS CAP IDs and the ACS CAP format specification. To display the list, log in on the host where ACSLS is running and execute the following command:

```
rlogin "ACSLS hostname" -l acssa
```

Enter the terminal type and wait for the command prompt. At the ACSSA prompt, enter the following command:

```
ACSSA> query cap all
```

The format specification of an ACS CAP must be the following:

ACS CAP: ID: #, #, # - (ACS num, LSM num, CAP num)

- A list of UNIX device files for the drives, if you want to install a Media Agent on a UNIX system.

Run the `ioscan -fn system` command on your system to display the required information.

For more information on UNIX device files, see [“Connecting a backup device to HP-UX systems”](#) on page 96.

- A list of SCSI addresses for the drives, if you want to install a Media Agent on a Windows system. For example, `scsi4:0:1:0`.

For more information on SCSI addresses, refer to [“Connecting a backup device to Windows systems”](#) on page 91.

- Make sure that the drives that will be used for Data Protector are in the `online` state. If a drive is not in the `online` state, change the state with the following command on the ACSLS host: `vary drive drive_id online`
- Make sure that the CAPs that will be used for Data Protector are in the state `online` and in `manual operating mode`.

If a CAP is not in the `online` state, change the state using the following command: `vary cap cap_id online`

If a CAP is not in `manual operating mode`, change the mode using the following command: `set cap manual cap_id`

Installing a Media Agent to use the StorageTek Library

The installation procedure consists of the following steps:

1. Distribute a Media Agent component to clients using the Data Protector graphical user interface and Installation Server for UNIX. See [“Remote installation of Data Protector clients”](#) on page 77 in this chapter.

2. Start the ACS `ssi` daemon for every ACS client:
 - On HP-UX, Solaris, and Linux ACS clients, run the following command:

```
/opt/omni/acs/ssi.sh start ACS_LS_hostname
```
 - On Windows ACS clients, install the `LibAttach` service. Refer to the ACS documentation for details. Make sure that during the configuration of `LibAttach` service the appropriate ACSLS hostname is entered. After successful configuration, the `LibAttach` services are started automatically and will be started automatically after every reboot as well.
 - On AIX ACS clients, run the following command:

```
/usr/omni/acs/ssi.sh start ACS_LS_hostname
```



NOTE:

After you have installed the `LibAttach` service, check if the `libattach\bin` directory has been added to the system path automatically. If not, add it manually.

For more information on the `LibAttach` service, see the documentation that comes with the StorageTek library.

3. Run the following command to check whether or not the library drives are properly connected to your system:
 - On HP-UX, Solaris, and Linux ACS client:

```
/opt/omni/lbin/devbra -dev
```
 - On Windows ACS client:

```
Data_Protector_home\bin\devbra -dev
```
 - On AIX ACS client:

```
/usr/omni/bin/devbra -dev
```

You should see the library drives with corresponding device files/SCSI addresses displayed in the list.

What's next?

Once a Media Agent is installed and the StorageTek library is physically connected to the system, refer to the online Help index: "configuring, backup devices" for information about additional configuration tasks, such as configuring backup devices and media pools.

Local installation of the Novell NetWare clients

The installation procedure of the Novell NetWare clients has to be performed from a supported Windows system that is connected to the Novell network.

You can install the Data Protector Disk Agent and General Media Agent on the systems running Novell NetWare. For information on Data Protector components, refer to “[Data Protector components](#)” on page 72.

Refer to the *HP Data Protector product announcements, software notes, and references* for details about supported devices, Novell NetWare platform versions, as well as for known problems and workarounds.

Prerequisites

Before you install Data Protector on the Novell NetWare platform, check the following:

- For system requirements, disk space requirements, supported platforms, and Data Protector components, refer to the *HP Data Protector product announcements, software notes, and references*.
- Make sure the TCP/IP transport protocol is installed and functional.
- Make sure that one of the following services is running on the Windows system:
 - A Gateway Service for Novell NetWare.
This service should run on Windows when an installation is executed from the Windows Server.
 - A Novell Client for Windows or a Microsoft Client Service for NetWare.
This service should run on the Windows when an installation is executed from the Windows workstation.
- Log in to the target NetWare server (or the appropriate NDS/eDirectory tree) from the Windows system.
- Ensure that you have supervisor rights for the SYS: volume on the target NetWare server.
- Make sure that you have at least one local device name free on your Windows system.

Cluster-aware clients

Additional prerequisites are required for installing cluster-aware clients. Refer to “[Installing a client](#)” on page 203 for more details.

Installation

The installation procedure can be performed from the Data Protector Windows DVD-ROM. Note that the Novell NetWare installation is not a part of the Installation Server functionality.

To install Data Protector on the Novell NetWare server, proceed as follows:

1. Run a command prompt on your Windows system and change the current path to the DVD-ROM root directory

2. Run the installation script.

To install the Data Protector Novell NetWare client, change the current path to the `NetWare` directory and type:

```
NWInstall target server name ALL|DA|MA port_number
```

The second parameter defines which part of the Data Protector Novell Client will be installed:

- Type `ALL` to install the whole Data Protector Novell NetWare client functionality.
- Type `DA` to install only the Data Protector Disk Agent for Novell NetWare.
- Type `MA` to install only the Data Protector General Media Agent for Novell NetWare.



NOTE:

For the Data Protector installation on each Novell NetWare version, the port number is optional. If it is not specified, the default port 5555 will be used.

If your Novell NetWare OS version is not supported by Data Protector, the installation is still possible but you receive a corresponding warning.

The installation now verifies whether Data Protector files are already present on the target server. If so, the old Data Protector installation will be moved to the `SYS:\usr\Omni.old` directory.

Depending on the installed NetWare client version, check whether `OMNIINET.NLM`, `HPINET.NLM` or `HPBRAND.NLM` is running on the server. If one of these programs is running, unload it by typing the following command at the Novell NetWare console:

```
UNLOAD HPINET (UNLOAD OMNIINET / UNLOAD HPBRAND)
```

The installation automatically creates a Data Protector directory structure and copies all Data Protector files to the target server.

3. Make sure that you have loaded the following modules on your system :

- NETDB.NLM
- TSAFS.NLM
- TSANDS.NLM

This way you enable the loader to resolve public symbols while trying to load HPINET.NLM.

If you have configured Novell NetWare Cluster Services on your Novell NetWare 6.x system, make sure that you have loaded the NCSSDK.NLM module.

4. To load HPINET.NLM, type at the Novell NetWare console:

```
SEARCH ADD SYS:USR\OMNI\BIN
LOAD HPINET.NLM
```

 **NOTE:**

When not using the default port number 5555, specify the port number by adding the `-port port_number` option to the LOAD command. For example:

```
LOAD HPINET.NLM -port port_number
```

To enable automatic recognition of the Data Protector Cell Manager by the Novell NetWare server, the installation will automatically add the console commands to the AUTOEXEC.NCF file, so that the HPINET.NLM file is always loaded and ready to connect to the Data Protector Cell Manager.

 **NOTE:**

You should verify your AUTOEXEC.NCF file after the installation is finished. If the necessary console commands were not added to the AUTOEXEC.NCF file during installation, you have to add them manually.

To enable backup and restore of the NDS/eDirectory database, complete the following steps:

- 1.** Define the user account to be used when performing backup and restore of NDS/eDirectory.

2. From the Novell NetWare console, load the `HPLOGIN.NLM` module:

```
LOAD HPLOGIN.NLM
```

3. Provide the following user information to the `HPLOGIN.NLM` file to enable successful login to the NDS/eDirectory database:

- NDS/eDirectory Context:

The context describes the container where the user objects reside. The container name must be a fully distinguished name syntax. For example:

```
OU=SDM.O=HSL
```

- NDS/eDirectory Object Name:

This is the Common Name of the user object that will be used as a valid NDS/eDirectory user for logging in to the NDS/eDirectory database when Data Protector Disk Agent performs backup or restore of the NDS/eDirectory. The selected user must be located in the previously applied context. For example:

```
CN=MarcJ
```

if the selected user's fully distinguished name has

```
.CN=MarcJ.OU=SDM.O=HSL syntax.
```

- NDS/eDirectory Object Password:

A valid user password that is used with the user name for logging in to the NDS/eDirectory database when a backup or restore of the NDS/eDirectory database is started.

User information entered in the `HPLOGIN` module is encoded and stored to the `SYS:SYSTEM` directory. It is also used in conjunction with Novell NetWare SMS modules that must be loaded and functional.



NOTE:

The user account selected in the `HPLOGIN` module must have permissions to perform backup and restore of the NDS/eDirectory database.

If changes are made on the NDS/eDirectory used object (moved to another container, deleted, renamed, changed password), the information encoded in the `SYS:SYSTEM` directory must be updated in the `HPLOGIN` module.

4. To back up and restore NDS/eDirectory with Novell NetWare Storage Management Services (SMS), the `SMDR.NLM` and `TSANDS.NLM` modules must be loaded on at least one server in the NDS/eDirectory tree. You can download the latest versions of `TSANDS.NLM` and `SMDR.NLM` from the Web at <http://support.novell.com/filefinder/>.

The installation automatically adds the `LOAD TSANDS.NLM` line to the `AUTOEXEC.NCF` file, so the Novell NetWare server can immediately recognize `TSANDS.NLM`. The Novell NetWare SMS module `SMDR.NLM` is loaded as soon as `TSANDS.NLM` is loaded.

 **NOTE:**

If the installation did not add console commands to the `AUTOEXEC.NCF` file, you should do it manually.

 **TIP:**

To minimize network traffic during the backup process, load the modules on the server containing a replica of the largest NDS/eDirectory partition.

Now you have fulfilled the requirements for the backup and restore of NDS/eDirectory. Refer to the online Help index: “configuring” for instructions about additional configuration tasks.

Media Agent configuration

At this stage, all Data Protector components are already installed. However, if you selected `ALL` or the `MA` parameter at the beginning of the installation procedure, you have to perform a few additional configuration tasks to enable the Data Protector General Media Agent to use backup devices connected to the Novell NetWare server.

Data Protector supports the Adaptec SCSI host adapter controller and its corresponding `.HAM` driver. The Data Protector Media Agent can directly communicate with the `.HAM` driver in order to access the SCSI host adapter. Therefore, you need to have the SCSI host adapter driver installed. For example, you can download the latest versions of Adaptec drivers from <http://www.adaptec.com>.

The driver can be loaded automatically whenever the server is restarted if you add a `LOAD` command to the `STARTUP.NCF` file. The command must specify the location

of the driver, any available options, and the slot number. See the *Adaptec Driver User's Guide* for the list of available options and calculation of the slot number.

Example

To automatically load the AHA-2940 Adaptec driver on the Novell NetWare 6.x server whenever the server is restarted, add the following lines to the `STARTUP.NCF` file:

```
SET RESERVED BUFFERS BELOW 16 MEG=200
LOAD AHA2940.HAM SLOT=4 lun_enable=03
```

where `SLOT` defines the location of the host adapter device and the `lun_enable` mask enables scanning for specific LUNs on all targets.

A scan for every LUN is enabled for all SCSI addresses by 1 in its corresponding bit position. For example, `lun_enable=03` enables scanning for LUNs 0 and 1 on all targets.



NOTE:

`lun_enable` is required only if you use devices which have SCSI LUNs higher than 0. For example, when you configure an HP StorageWorks Tape 12000e library device.



TIP:

To automatically scan for all devices connected to the Novell NetWare server and their LUNs whenever the server is restarted, add the following lines to the `AUTOEXEC.NCF` file:

```
SCAN FOR NEW DEVICES
SCAN ALL LUNS
```

The General Media Agent configuration is now complete.

What's next?

Once you have the General Media Agent software successfully installed on the Novell NetWare platform, it is advisable to check the Data Protector General Media Agent installation. See ["Checking the General Media Agent Installation on Novell NetWare"](#) on page 438.

As soon as you have verified the installation, you are ready to import the Novell NetWare client to the Data Protector cell using the Data Protector graphical user interface. Refer to the online Help index: “Novell NetWare” for information on additional configuration tasks.

Local installation of OpenVMS clients

The installation procedure for OpenVMS clients has to be performed locally on a supported OpenVMS system. Remote installation is not supported.

You can install the Data Protector Disk Agent, General Media Agent, and the User Interface (command-line interface only) on systems running OpenVMS 7.3-1/IA64 8.2. You can also install the Oracle Integration component on systems running OpenVMS 7.3-1 or above. For information on Data Protector components, refer to “[Data Protector components](#)” on page 72.

Refer to the *HP Data Protector product announcements, software notes, and references* for information on supported devices, OpenVMS platform versions, as well as for limitations, known problems and workarounds.

Prerequisites

Before you install a Data Protector client on the OpenVMS platform, check the following:

- Make sure the TCP/IP transport protocol is installed and running.
- Set the TIMEZONE features of your system by executing the command `SYS$MANAGER:UTC$TIME_SETUP.COM`.
- Log in to the `SYSTEM` account of the OpenVMS system. Note that you must have appropriate permissions.
- Make sure that you have access to the Data Protector installation DVD-ROM containing the OpenVMS client installation package.

Installation

The installation procedure can be performed from the Data Protector Windows installation DVD-ROM. Note that the OpenVMS installation is not a part of the Installation Server functionality.

To install a Data Protector client on an OpenVMS system, proceed as follows:

1. If you already have the PCSI installation file go to step [Step 2](#) on page 136. To get the PCSI installation file, mount the installation CD and execute the program `DPVMSKIT.EXE` found in the `OpenVMS` directory on the CD. The PCSI installation file will be extracted to your default directory, or the destination provided.

2. Run the following command:

```
$ PRODUCT INSTALL DP /SOURCE=device:[directory]
```

where `device:[directory]` is the location of the `.PCSI` installation file.

3. Verify the version of the kit by responding `YES` to the prompt:

```
The following product has been selected: HP AXPVMS DP  
A06.10-xx Layered Product Do you want to continue? [YES]
```

4. Choose the software components you wish to install. You may take the defaults and the Disk Agent, General Media Agent, and User Interface will be installed. Note that the Oracle Integration (Alpha systems only) is not installed by default. You may also select each component individually.

You will be asked to choose options, if any, for each selected product and for any product that may be installed to satisfy software dependency requirements.

Example

```
HP AXPVMS DP A6.10-xx: HP AXPVMS Data Protector V6.10
Copyright 2008 Hewlett-Packard Development Company, L.P.
Do you want the defaults for all options? [YES] NO
Do you wish to install a disk agent for this client node?
[YES] YES
Do you wish to install a media agent for this client node?
[YES] YES
Do you wish to install the command language interface
(CLI)?
[YES] YES
Do you want to review the options?
[NO] YES
HP AXPVMS DP A6.10-xx: HP OpenVMS Alpha Data Protector
V6.10 [Installed]
Do you wish to install a disk agent for this client node?:
YES
Do you wish to install a media agent for this client node?:
YES
Do you wish to install the command language interface
(CLI)?:
YES
Do you wish to install the Oracle Integration Agents?
[NO] YES
```

Are you satisfied with these options?

[YES] YES

The default location for the Data Protector directories and files is:

```
SYS$SYSDEVICE: [VMS$COMMON.OMNI]
```

The directory structure will be created automatically and the files will be placed in this directory tree.

The Data Protector startup and shutdown command procedures will be placed in

```
SYS$SYSDEVICE: [VMS$COMMON.SYS$STARTUP]
```

There are four files that are always present for an OpenVMS client and a fifth file that only exists if you chose the CLI option. The five files concerned are:

- `SYS$STARTUP:OMNI$STARTUP.COM` This is the command procedure that starts Data Protector on this node.
- `SYS$STARTUP:OMNI$SYSTARTUP.COM` This is the command procedure that defines the `OMNI$ROOT` logical name. Any other logical names required by this client may be added to this command procedure.
- `SYS$STARTUP:OMNI$SHUTDOWN.COM` This is the command procedure that shuts down Data Protector on this node.
- `OMNI$ROOT:[BIN]OMNI$STARTUP_INET.COM` This is the command procedure that is used to start the `TCP/IP INET` process, which then executes the commands sent by the Cell Manager.
- `OMNI$ROOT:[BIN]OMNI$CLI_SETUP.COM` This is the command procedure that defines the symbols needed to invoke the Data Protector CLI. It will only exist on the system if you chose the CLI option during installation.

Execute this command procedure from the `login.com` procedures for all users who will use the CLI interface. Several logical names are defined in this procedure which are necessary to execute the CLI commands correctly.

5. Insert the following line in `SYS$MANAGER:SYSTARTUP_VMS.COM`:

```
@sys$startup:omni$startup.com
```

6. Insert the following line in `SYS$MANAGER:SYSHUTDWN.COM`:

```
@sys$startup:omni$shutdown.com
```

7. Ensure that you can connect from the OpenVMS client to all possible TCP/IP aliases for the Cell Manager.

8. Import the OpenVMS client to the Data Protector cell using the Data Protector graphical user interface as described in “[Importing clients to a cell](#)” on page 207.

An account with the name OMNIADMIN was created during the installation. The OMNI service runs under this account.

The login directory for this account is OMNI\$ROOT: [LOG] and it holds the log file OMNI\$STARTUP_INET.LOG for each startup of a Data Protector component. This log file contains the name of the process executing the request, the name of Data Protector image used and the options for the request.

Any unexpected errors are logged in the DEBUG.LOG in this directory.

Installation in a cluster environment

If you use a common system disk, the client software needs to be installed only once. However, the OMNI\$STARTUP.COM procedure needs to be executed for each node to be usable as a Data Protector client. If you do not use a common system disk the client software needs to be installed on each client.

If you use a cluster TCP/IP alias name, you can define a client for the alias name as well if you are using a cluster common system disk. With the alias client defined you do not have to configure the individual client nodes. You can choose either client definition or alias definition to run your backups and restores in a cluster. Depending on your configuration, the save or restore may or may not use a direct path to your tape device or tape library.

Disk Agent configuration

The Data Protector Disk Agent on OpenVMS supports mounted FILES-11 ODS-2 and ODS-5 disk volumes. There is no need to configure the OpenVMS Disk Agent. There are, however, some points to bear in mind when setting up a backup specification that will use it. These are described below:

- The file specifications entered into the GUI or passed to the CLI must be in UNIX style syntax, for instance:

```
/disk/directory1/directory2/.../filename.ext.n
```

- The string must begin with a slash, followed by the disk, directories and filename, separated by slashes.
- Do not place a colon after the disk name.
- A period should be used before the version number instead of a semi-colon.
- File specifications for OpenVMS files are case-insensitive, except for the files residing on ODS-5 disks.

Example

An OpenVMS file specification of:

```
$1$DGA100:[USERS.DOE]LOGIN.COM;1
```

must be specified to Data Protector in the form:

```
/$1$DGA100/Users/Doe/Login.Com.1
```

NOTE:

There is no implicit version number. You must always specify a version number and only the file version specified for the backup will be backed up.

For some options which allow wildcards the version number can be replaced with an asterisk '*'.
For example:

If you want to include all versions of the file in a backup, you must select them all in the GUI or, in the CLI, include the file specifications under the `-only` option, using wildcards for the version number, as follows:

```
/DKA1/dir1/filename.txt.*
```

Media Agent configuration

You should configure devices on your OpenVMS system using OpenVMS and hardware documentation as a guide. The pseudo devices for the tape library must be created first using SYSMAN, as follows:

```
$ RUN SYS$SYSTEM:SYSMAN
```

```
SYSMAN> IO CONNECT gcan/NOADAPTER/DRIVER=SYS$GcDRIVER
```

where:

- `c` = K for direct connected SCSI tape libraries.
- `a` = A,B,C, ...the adapter character for the SCSI controller.
- `n` = the unit number of the tape library's robotic control device.

NOTE:

This command sequence must be executed after a system boot.

For SAN attached tape libraries the tape drives and robot device name should show up automatically under OpenVMS once the SAN devices have been configured according to SAN guidelines.

If you are installing tape jukeboxes for use with Data Protector, you should verify that the hardware is working correctly before configuring it within Data Protector. You may use the Media Robot Utility (MRU), available from Hewlett-Packard, to verify the hardware.

 **NOTE:**

You can generally use the Data Protector GUI to manually configure or auto-configure these devices.

However, certain older tape libraries and all tape libraries connected to HSx controllers cannot be auto-configured. Use manual configuration methods to add these devices to Data Protector.

Media Agent in a cluster

When dealing with devices attached to cluster systems:

1. Configure each tape device and tape library so that it can be accessed from each node.
2. Add the node name to the end of the device name to differentiate between the devices.
3. For tape devices, set a common `Device Lock Name` under `Devices/Properties/Settings/Advanced/Other`.

Example

In a cluster with nodes A and B, a TZ89 is connected to node A and MSCP served to node B. Configure a device named `TZ89_A`, with node A as the client and configure a device named `TZ89_B`, with node B as the client. Both devices get a common device lock name of `TZ89`. Now Data Protector can use the devices via either path, knowing that this is actually only one device. If you run a backup on node B using `TZ89_A`, Data Protector moves the data from node B to the device on node A. If you run a backup on node B using `TZ89_B` the OpenVMS MSCP server moves the data from node B to the device on node A.

 **NOTE:**

For MSCP served tape devices in a cluster, for all tape devices connected via an HSx controller and for all tape devices connected via Fibre Channel, follow the guidelines for SAN configurations in the online Help index: “SAN, configuring devices in”.

Command-line interface

Before you can use the Data Protector command-line interface on OpenVMS you must run the CLI command setup procedure, as follows:

```
$ @OMNI$ROOT:[BIN]OMNI$CLI_SETUP.COM See the HP Data Protector command line interface reference for a description of the available CLI commands.
```

Oracle integration

After you installed the Oracle integration and configured it as described in the *HP Data Protector integration guide for Oracle and SAP*, verify that the `-key Oracle8` entry is present in `OMNI$ROOT:[CONFIG.CLIENT]omni_info`, for example:

```
-key oracle8 -desc "Oracle Integration" -nlset 159 -nlid 12172 -flags 0x7 -ntpath "" -uxpath "" -version A.06.10
```

If the entry is not present, copy it from

`OMNI$ROOT:[CONFIG.CLIENT]omni_format`. Otherwise, the Oracle integration will not be shown as installed on the OpenVMS client.

What's next?

Refer to the online Help index: “OpenVMS” for information on additional configuration tasks.

Installing MPE/iX clients

Refer to the *HP Data Protector MPE/iX system user guide* for detailed information. If the documentation package is installed on your system (on HP-UX, Solaris, Linux or Windows), the guide is available as `MPE_user.pdf` in `Data_Protector_home\Docs` (on Windows), `/opt/omni/doc/C/` (on UNIX), or on the Data Protector Windows installation DVD-ROM in the `docs` directory.

Before starting the installation procedure, decide which components you need to install on your client system. For the list of the Data Protector software components and their descriptions, see “[Data Protector components](#)” on page 72.

Refer to the *HP Data Protector product announcements, software notes, and references* for information about supported devices, MPE/iX platform versions, and Data Protector components.

Prerequisites

Before you install Data Protector on the MPE/iX platform, check the following:

- TurboSTORE/iX or TurboSTORE/iX 7x24 True-Online is installed on your computer.
- The TCP/IP protocol is installed and configured.
- The name resolving mechanism (DNS or host files) is enabled.
- For disk space requirements refer to the HP Data Protector product announcements, software notes, and references.

Installation

To install Data Protector on the MPE/iX server, proceed as follows:

1. Transfer `installDP6.10_MPE.sh` and the `DP61_MPE6.5.tar` package, or `DP61_MPE7.0.tar` package (depending on the MPE/iX OS version) to the `/tmp` directory, using the `ftp` utility. See [Example 1](#) on page 144.

It is important that you transfer the `installDP6.10_MPE.sh` file with the following characteristics:

- Record size: `-150`
- Block factor: `-empty`
- Variable length of the records of the file: `v`
- Type of coded records: `ASCII`

Example 1. Transfer of the `install DP6.10_MPE.sh` script and `DP10_MPE6.5.tar` package

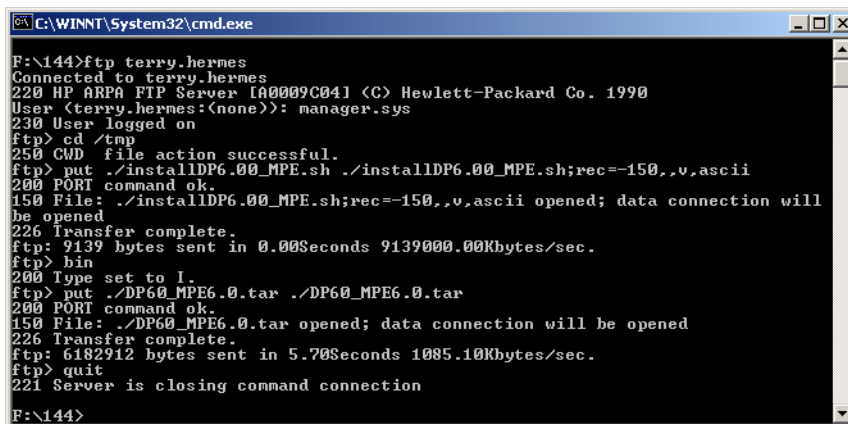

```
C:\WINNT\System32\cmd.exe
F:\144>ftp terry.hermes
Connected to terry.hermes
220 HP ARPA FTP Server [A0009C04] (C) Hewlett-Packard Co. 1990
User (terry.hermes:(none)): manager.sys
230 User logged on
ftp> cd /tmp
250 CWD file action successful.
ftp> put ./installDP6.00_MPE.sh ./installDP6.00_MPE.sh;rec=-150,,v,ascii
200 PORT command ok.
150 File: ./installDP6.00_MPE.sh;rec=-150,,v,ascii opened; data connection will
be opened
226 Transfer complete.
ftp: 9139 bytes sent in 0.00Seconds 9139000.00Kbytes/sec.
ftp> bin
200 Type set to I.
ftp> put ./DP60_MPE6.0.tar ./DP60_MPE6.0.tar
200 PORT command ok.
150 File: ./DP60_MPE6.0.tar opened; data connection will be opened
226 Transfer complete.
ftp: 6182912 bytes sent in 5.70Seconds 1085.10Kbytes/sec.
ftp> quit
221 Server is closing command connection
F:\144>
```

2. Log in to the target system and start the unpacking process, as shown in the following example:

Example 2. Unpacking process on target system

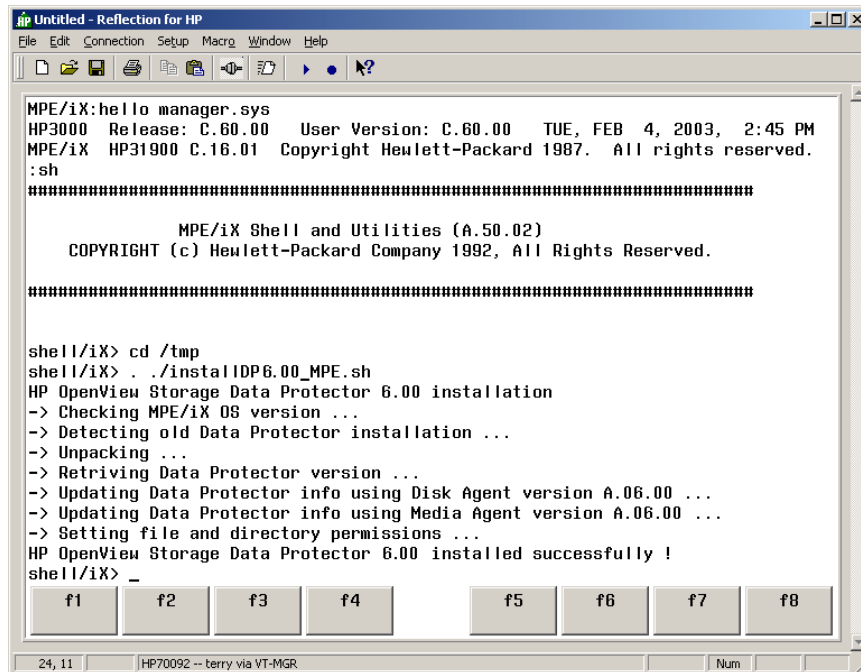

```
Untitled - Reflection for HP
File Edit Connection Setup Macro Window Help

MPE/iX:hello manager.sys
HP3000 Release: C.60.00 User Version: C.60.00 TUE, FEB 4, 2003, 2:45 PM
MPE/iX HP31900 C.16.01 Copyright Hewlett-Packard 1987. All rights reserved.
:sh
#####

MPE/iX Shell and Utilities (A.50.02)
COPYRIGHT (c) Hewlett-Packard Company 1992, All Rights Reserved.

#####

shell/iX> cd /tmp
shell/iX> ./instalIDP6.00_MPE.sh
HP OpenView Storage Data Protector 6.00 installation
-> Checking MPE/iX OS version ...
-> Detecting old Data Protector installation ...
-> Unpacking ...
-> Retriving Data Protector version ...
-> Updating Data Protector info using Disk Agent version A.06.00 ...
-> Updating Data Protector info using Media Agent version A.06.00 ...
-> Setting file and directory permissions ...
HP OpenView Storage Data Protector 6.00 installed successfully !
shell/iX> _

f1 f2 f3 f4 f5 f6 f7 f8

24, 11 HP70092 -- terry via VT-MGR Num
```

After this operation, the files are located in the `/usr/omni` directory.

NOTE:

Use `EDIT/3000` (invoked with the `editor` command) to change the files below. Refer to *EDIT/3000 Reference Manual* for more information.

3. Add the following line to the `DCNF.NET.SYS` file:

```
omni stream tcp nowait MANAGER.SYS /usr/omni/bin/inet inet
-log /tmp/inet.log
```
4. Add the following line to the `SERVICES.NET.SYS` file:

```
omni 5555/tcp #Data Protector inet
```

5. Restart `inetd` to update the configuration with the new settings.
Refer to the *Configuring and Managing MPE/iX Internet Services* manual for more information.
6. To check if the `Data Protector Inet` is running, telnet port 5555 from a different system:

```
telnet hostname 5555
```

You will get a message from Data Protector. If there is no response in 10 seconds, check the `INETDCNF.NET.SYS` and `SERVICES.NET.SYS` files.
7. Import the system to the Data Protector cell. For the procedure, refer to “[Importing clients to a cell](#)” on page 207.
8. When the client system is successfully imported, add the `MANAGER.SYS` user to the Data Protector `Admin` user group.

For more information on MPE/iX clients, refer to the *HP Data Protector MPE/iX system user guide*, which is located on the Windows installation DVD-ROM at `\Docs\MPE_user.pdf`.

Local installation of UNIX clients

If you do not have an Installation Server for UNIX installed on your network, or if for some reason you cannot remotely install a client system, Data Protector clients can be installed locally from the UNIX installation DVD-ROM.

Before starting the installation procedure, decide which components you need to install on your client system. For the list of the Data Protector software components and their descriptions, see “[Data Protector components](#)” on page 72.

Prerequisites

- For system requirements, disk space requirements, supported platforms, processors, and Data Protector components, refer to the *HP Data Protector product announcements, software notes, and references*.
- You must have `root` permissions on every target system.

A POSIX shell (`sh`) is required for the installation.



NOTE:

You can also use the following procedure to upgrade the UNIX clients locally. The script will detect a previous installation and will prompt you to perform the upgrade.

Procedure

Follow the procedure below to install UNIX clients locally:

1. Insert and mount the UNIX installation DVD-ROM.

2. From the `Mount_Point/LOCAL_INSTALL` directory run the `omnisetup.sh` command. The syntax of the command is as follows:

```
omnisetup.sh [-source directory] [-server name] [-install component_list]
```

where:

- *directory* is the location where the installation DVD is mounted. If not specified, the current directory is used.
- *name* is a full hostname of the Cell Manager of the cell to which you want to import the client. If not specified, the client will not be automatically imported to the cell.

 **NOTE:**

In case of upgrading the client that does not reside on the Cell Manager, you do not need to specify `-install component_list`. In this case, the setup will select the same components that were installed on the system before the upgrade without issuing a prompt.

However, to upgrade the client components residing on the Cell Manager, run the `omnisetup.sh` command with the `-install component_list` parameter after the Cell Manager upgrade has been completed.

-
- *component_list* is a comma-separated list of component codes to be installed. No spaces are allowed. If the `-install` parameter is not specified, Setup will prompt you separately about installing each available component on the system.

 **NOTE:**

In case of upgrading the client, if you do not specify the `-install` parameter, Setup will select the same components that were installed on the system before the upgrade started, without issuing a prompt.

The list of the components is presented in the table below. The exact list of the components is subject to the availability on the particular system. For the description of the components, see “[Data Protector components](#)” on page 72.

Table 7 Data Protector component codes

Component Code	Component
cc	User Interface
da	Disk Agent
ma	General Media Agent
ndmp	NDMP Media Agent
informix	Informix Integration
lotus	Lotus Integration
oracle	Oracle Integration
vmware	VMware Integration
ov	HP OpenView Network Node Manager
sybase	Sybase Integration
sap	SAP R/3 Integration
sapdb	SAP DB Integration
db2	DB2 Integration
emc	EMC Symmetrix Agent
ssea	HP StorageWorks Disk Array XP Agent
snapa	HP StorageWorks VA Agent
smisa	HP StorageWorks EVA SMIS-S Agent
docs	English Language Documentation and online Help
javagui	Java Graphical User Interface

Component Code	Component
fra_ls	French Language Support
jpn_ls	Japanese Language Support

Example

The example below shows how you can install the Disk Agent, General Media Agent, User Interface, and Informix components on a client that will be automatically imported to the cell with the Cell Manager computer.company.com:

```
./omnisetup.sh -server computer.company.com -install
da,ma,cc,informix
```

3. Setup informs you if the installation was completed and if the client was imported to the Data Protector cell.

The CORE component is installed the first time any software component is selected for installation.

The CORE-INTEG component is installed the first time any integration software component is selected for installation or reinstallation.

Running the installation from the hard disk

To copy the installation DVD-ROM to your computer and run the installation/upgrade of UNIX clients from the hard disk, copy at least the DP_DEPOT directory and the LOCAL_INSTALL/omnisetup.sh command. For example, if you copy installation packages to /var/dp61, DP_DEPOT must be a subdirectory of /var/dp61:

```
# pwd
/var/dp61
# ls
DP_DEPOT
omnisetup.sh
```

After you have copied this to the hard disk, you can run:

```
omnisetup.sh -source directory [-server name] [-install
component_list]
```

Note, that the `-source` option is required. For example:

```
./omnisetup.sh -source /var/dp61
```

What's next?

If you did not specify the name of the Cell Manager during the installation, the client will not be imported to the cell. In this case, you should import it using the Data Protector graphical user interface. For the procedure, refer to [“Importing clients to a cell”](#) on page 207. See the online Help for information on additional configuration tasks.

Installing the Data Protector integration clients

Data Protector integrations are software components that allow you to run an online backup of the database applications, such as Oracle or Microsoft Exchange, with Data Protector. Data Protector ZDB integrations are software components that allow you to run a ZDB using ZDB disk arrays, such as HP StorageWorks Enterprise Virtual Array.

The systems running database applications are called **integration clients**; the systems using ZDB disk arrays for backing up and storing data are called **ZDB integration clients**. Such clients are installed with the same installation procedure as any other clients on Windows or on UNIX, provided that the appropriate software component has been selected (for example, MS Exchange Integration component for backing up the Microsoft Exchange Server database, HP StorageWorks EVA SMI-S Agent component for a ZDB on HP StorageWorks Enterprise Virtual Array, and so on).

Prerequisites

- For system requirements, disk space requirements, supported platforms, processors, and Data Protector components, refer to the *HP Data Protector product announcements, software notes, and references*.
- You need a license to use the Data Protector integration with a database application (except for the VSS integration). For information about licensing, see [“Functional extensions”](#) on page 352.
- At this point, you should have the Cell Manager and Installation Server (optionally, for remote installation) already installed on your network. See [“Installing the Data Protector Cell Manager \(CM\) and Installation Server\(s\) \(IS\)”](#) on page 42 for instructions.

Before starting the installation procedure, decide which other Data Protector software components you want to install on your client together with an integration component. For the list of the Data Protector software components and their descriptions, see [“Data Protector components”](#) on page 72.

Note that in the cases stated below you need to install the following Data Protector components:

- The `Disk Agent` component to be able to back up filesystem data with Data Protector. You can use the Disk Agent for the following purposes:
 - To run a filesystem backup of important data that *cannot* be backed up using a database application backup.
 - To run a filesystem test backup of a database application server (for example, Oracle Server or MS SQL Server). You need to test a filesystem backup *before* configuring the Data Protector integration with a database application and resolve communication and other problems related to the application and Data Protector.
 - To run disk image and filesystem ZDB.
 - To restore from backup media to the application system on LAN in case of SAP R/3 ZDB integrations.
- The `User Interface` component to gain access to the Data Protector GUI and the Data Protector CLI on the Data Protector integration client.
- The `General Media Agent` component if you have backup devices connected to the Data Protector integration client. On Data Protector clients used to access an NDMP dedicated drive through the NDMP Server, the `NDMP Media Agent` is required.

Integration clients can be installed locally from the Windows or UNIX Installation Server installation DVD-ROM, or remotely using the Installation Server for Windows or for UNIX.

For additional information on specific integration clients, refer to the corresponding sections below:

- [“Microsoft Exchange Server clients”](#) on page 154
- [“Microsoft SQL Server clients”](#) on page 155
- [“Microsoft SharePoint Portal Server Clients”](#) on page 155
- [“Sybase clients”](#) on page 155
- [“Informix Server clients”](#) on page 155
- [“SAP R/3 clients”](#) on page 156
- [“SAP DB clients”](#) on page 156
- [“Oracle clients”](#) on page 157

- “VMware Virtual Infrastructure clients” on page 157
- “DB2 clients” on page 158
- “NNM clients” on page 158
- “NDMP clients” on page 158
- “Microsoft Volume Shadow Copy Service clients” on page 159
- “Lotus Notes/Domino Server clients” on page 159
- “EMC Symmetrix integration” on page 159
- “HP StorageWorks Disk Array XP integration” on page 164
- “HP StorageWorks Virtual Array integration” on page 170
- “HP StorageWorks Enterprise Virtual Array integration” on page 176

When you have finished installing Data Protector integration software to Data Protector integration clients as described in the listed sections, refer to the appropriate *HP Data Protector integration guide*, *HP Data Protector zero downtime backup administrator's guide*, or to the *HP Data Protector zero downtime backup integration guide to configure Data Protector integration clients*.

Local installation

If you do not have an Installation Server for the respective operating system installed in your environment, you have to perform local installation from the Windows or UNIX installation DVD-ROM depending on the platform you install a client to. See “[Installing Windows clients](#)” on page 86 or “[Local installation of UNIX clients](#)” on page 146 for instructions.

If you do not choose a Cell Manager during the installation, the client system has to be manually imported into the cell after the local installation. See also “[Importing clients to a cell](#)” on page 207.

Remote installation

You install the client software from the Installation Server to clients using the Data Protector graphical user interface. For the step-by-step procedure for remotely installing the software, refer to “[Remote installation of Data Protector clients](#)” on page 77.

After the remote installation, the client system automatically becomes a member of the Data Protector cell.

Installing cluster-aware integrations

The Data Protector cluster-aware integration clients must be installed locally, from the DVD-ROM, on each cluster node. During the local client setup, install, in addition to the other client software components, the appropriate integration software components (such as Oracle Integration or HP StorageWorks EVA SMI-S Agent).

You can also install a cluster-aware database application and a ZDB Agent on the Data Protector Cell Manager. Select the appropriate integration software component during the Cell Manager setup.

The installation procedure depends on a cluster environment where you install your integration client. See the clustering related sections corresponding to your operating system:

- [“Installing Data Protector on MC/ServiceGuard”](#) on page 190.
- [“Installing Data Protector on Microsoft Cluster Server”](#) on page 191.
- [“Installing Data Protector clients on a Veritas Cluster”](#) on page 202.
- [“Installing Data Protector clients on a Novell NetWare Cluster”](#) on page 203.

For more information on clustering, refer to the online Help index: “cluster, MC/ServiceGuard” and *HP Data Protector concepts guide*.

What’s next?

When the installation has been completed, refer to the appropriate *HP Data Protector integration guide* for information on configuring the integration.

Microsoft Exchange Server clients

It is assumed that your Microsoft Exchange Server is up and running.

To be able to back up the Microsoft Exchange Server database or individual mailboxes, you need to select the MS Exchange Integration component during the installation procedure.

The Microsoft Exchange Single Mailbox integration agent will be installed as part of the Data Protector Microsoft Exchange Server integration package.

On Microsoft Exchange Server 2007 systems, you need to install an additional package to enable the functionality of the Data Protector Microsoft Exchange Single Mailbox integration. The package is named Microsoft Exchange Server MAPI Client and Collaboration Data Objects (`ExchangeMapiCdo.EXE`), and can be downloaded

free of charge from the Microsoft web site <http://www.microsoft.com/downloads/Search.aspx?displaylang=en>.

Microsoft SQL Server clients

It is assumed that your Microsoft SQL Server is up and running.

To be able to back up the Microsoft SQL Server database, you need to select the `MS SQL Integration` component during the installation procedure.

Microsoft SharePoint Portal Server Clients

It is assumed that your Microsoft SharePoint Portal Server and the Microsoft SQL Server instances are up and running.

To be able to back up Microsoft SharePoint Portal Server objects, install the following Data Protector components:

- `MS SharePoint Integration` - on Microsoft SharePoint Portal Server systems
- `MS SQL Integration` - on Microsoft SQL Server systems

Sybase clients

It is assumed that your Sybase Backup Server is running.

For backing up the Sybase database, you need to select the following Data Protector component during the installation procedure:

- `Sybase Integration` - to be able to back up a Sybase database
- `Disk Agent` - install the Disk Agent for two reasons:
 - To run a filesystem backup of Sybase Backup Server. Make this backup *before* configuring your Data Protector Sybase integration and resolve all problems related to Sybase Backup Server and Data Protector.
 - To run a filesystem backup of important data that *cannot* be backed up using Sybase Backup Server.

Informix Server clients

It is assumed that your Informix Server is up and running.

For backing up the Informix Server database, you need to select the following Data Protector component during the installation procedure:

- Informix Integration - to be able to back up an Informix Server database
- Disk Agent - install the Disk Agent for two reasons:
 - To run a filesystem backup of Informix Server. Make this backup *before* configuring your Data Protector Informix Server integration and resolve all problems related to Informix Server and Data Protector.
 - To run a filesystem backup of important Informix Server data (such as, ONCONFIG file, `sqlhosts` file, ON-Bar emergency boot file, `oncfg_INFORMIXSERVER.SERVERNUM`, configuration files, etc.) that *cannot* be backed up using ON-Bar.

SAP R/3 clients

Prerequisites

- Ensure that the following Oracle software is installed and configured:
 - Oracle Enterprise Server (RDBMS)
 - Oracle Net8 software
 - SQL*Plus
- It is assumed that your SAP R/3 Database Server is up and running.



NOTE:

The Data Protector SAP R/3 integration backup specifications are fully compatible with the previous version of Data Protector. Data Protector will run all backup specifications created by earlier Data Protector versions. You cannot use backup specifications created by the current version of Data Protector on older versions of Data Protector.

To be able to back up the SAP R/3 database, select the following components during the installation procedure:

- SAP R/3 Integration
- Disk Agent

Data Protector requires a Disk Agent to be installed on Backup Servers (clients with filesystem data to be backed up).

SAP DB clients

It is assumed that your SAP DB Server is up and running.

To be able to back up the SAP DB database, you need to select the following Data Protector components during the installation procedure:

- SAP DB Integration - to be able to run an integrated online backup of an SAP DB database
- Disk Agent - to be able to run a non-integrated offline backup of an SAP DB database

Oracle clients

It is assumed that your Oracle Server is up and running.

To be able to back up the Oracle database, you need to select the `Oracle Integration` component during the installation procedure.

OpenVMS

On OpenVMS, after you installed the Oracle integration and configured it as described in the *HP Data Protector integration guide for Oracle and SAP*, verify that the `-key Oracle8` entry is present in `OMNI$ROOT:[CONFIG.CLIENT]omni_info`, for example:

```
-key oracle8 -desc "Oracle Integration" -nlset 159 -nlsId 12172 -flags 0x7 -ntpath "" -uxpath "" -version A.06.10
```

If the entry is not present, copy it from

`OMNI$ROOT:[CONFIG.CLIENT]omni_format`. Otherwise, the Oracle integration will not be shown as installed on the OpenVMS client.

VMware Virtual Infrastructure clients

It is assumed that VirtualCenter systems (if they exist) and ESX Server systems are up and running.

To be able to back up virtual machines, install the `VMware Integration` component on every VirtualCenter system and every ESX Server system in your environment. If you plan to use the consolidated backup methods (**VCBfile** and **VCBimage**), install the integration component also on the backup proxy systems.

Clusters

Install the `VMware Integration` component on both cluster nodes, regardless of whether you have ESX Server systems or VirtualCenter systems in a cluster.

VCBfile backup method

To be able to restore virtual machine filesystems directly to a virtual machine, install the `VMware Integration` component also on the virtual machine.

DB2 clients

It is assumed that your DB2 Server is up and running.

To be able to back up the DB2 database, you need to select the `DB2 Integration` and the `Disk Agent` components during the installation procedure.

In a physically partitioned environment, install the `DB2 Integration` and `Disk Agent` components on every physical node (system) on which the database resides.

NOTE:

Log in as user `root` to perform the installation.

NNM clients

It is assumed that your NNM system is up and running.

To be able to back up the NNM database, you need to select the `HP OpenView NNM Backup Integration` and the `Disk Agent` components during the installation procedure. You will need the `Disk Agent` to run pre-backup and post-backup scripts used for backup purposes.

NDMP clients

It is assumed that your NDMP Server is up and running.

During the installation procedure, select the `NDMP Media Agent` and install it to all `Data Protector` clients accessing the NDMP dedicated drives.

NOTE:

If a `Data Protector` client will not be used to access an NDMP dedicated drive through the NDMP Server, but it will be used only to control the robotics of the library, either the `NDMP Media Agent` or the `General Media Agent` can be installed on such a client.

Note that only one Media Agent can be installed on one Data Protector client.

Microsoft Volume Shadow Copy Service clients

Prerequisite

MS Volume Shadow Copy integration is supported on Windows Server 2003 operating system.

To be able to perform shadow copy backups of the VSS-aware writers, select the MS Volume Shadow Copy Integration component during the installation.

For VSS transportable backups, Windows Advanced Server 2003 is required. Install the following components on the application and backup systems:

- MS Volume Shadow Copy Integration
- General Media Agent

Lotus Notes/Domino Server clients

It is assumed that your Lotus Notes/Domino Server is up and running.

To be able to back up the Lotus Notes/Domino Server database, you need to select the Lotus Integration and the Disk Agent components during the installation procedure. You will need the Disk Agent component to be able to back up filesystem data with Data Protector in the following purposes:

- Backing up important data that *cannot* be backed up using Lotus Integration Agent. These are so called non-database files, which need to be backed up to provide a complete data protection solution for a Lotus Notes/Domino Server, such as `notes.ini`, `desktop.dsk`, all `*.id` files.
- Testing the filesystem backup to resolve communication and other problems related to the application and Data Protector.

EMC Symmetrix integration

To integrate EMC Symmetrix with Data Protector, install the following Data Protector software components on the application and backup systems:

- EMC Symmetrix Agent (SYMA)
- General Media Agent

Install the `General Media Agent` component on the backup system to back up the bulk data. Install it on the application system to back up archive logs or to perform a restore to the application system.

- `Disk Agent`

Install the `Disk Agent` component on the application and backup systems to run disk image and filesystem ZDB. Clients without `Disk Agent` installed are not listed in the `Application system` and `Backup system` drop-down lists when creating a ZDB specification.

Installing in a cluster

You can install the EMC Symmetrix integration in a cluster environment. For the supported cluster configurations and specific installation requirements, see the *HP Data Protector zero downtime backup administrator's guide*.

Integrating with other applications

If you want to install the EMC Symmetrix integration with a database application, install the Data Protector component specific for the particular integration to the application and backup systems and perform the installation tasks specific for this integration. You can install the EMC Symmetrix integration with Oracle and SAP R/3.

EMC Symmetrix Integration with Oracle

Prerequisites

- The following software must be installed and configured on the application system:
 - Oracle Enterprise Server (RDBMS)
 - Oracle Net services
 - SQL*Plus

- The Oracle database files used by the application system must be installed on EMC Symmetrix devices which are mirrored to the backup system.

The database can be installed on disk images, logical volumes or filesystems. The following Oracle files have to be mirrored:

- Datafiles
- Control file
- Online redo log files

The archive redo log files have to reside on non-mirrored disks.

Installation procedure

Perform the following installation tasks:

1. Install the Oracle recovery catalog database.
See the Oracle documentation for information on how to install the Oracle recovery catalog database on the application system on non-mirrored disks. Leave the recovery catalog unregistered.
2. Install the following Data Protector software components:
 - `EMC Symmetrix Agent` - on both the application and backup systems.
 - `Oracle Integration` - if you use the backup set ZDB method, install this component on both the application and backup systems; if you use the proxy-copy ZDB method, install it on the application system only.

EMC Symmetrix Integration with SAP R/3

Prerequisites

- The following Oracle software must be installed and configured on the application system:
 - Oracle Enterprise Server (RDBMS)
 - Oracle Net8 software
 - SQL*Plus
- If you plan to run SAP compliant ZDB sessions (BRBACKUP started on the backup system and not on the application system), correctly configure the backup system. For details, see the SAP database guide for Oracle (split mirror backup, software configuration).
- The database on the application system can be installed on disk images, logical volumes, or filesystems.
 - The Oracle datafiles *must* reside on a disk array.
 - For *online backup*, the control file and online redo logs do not have to reside on a disk array. *Online* SAP compliant ZDB sessions are an exception, for which the control file must reside on a disk array.
 - For *offline backup*, the control file and online redo logs *must* reside on a disk array.
 - The archived redo log files do not have to reside on a disk array.

 **NOTE:**

If some of the Oracle data files are installed on symbolic links, create the links on the backup system too.

UNIX only: If the Oracle database is installed on raw partitions (rawdisk or raw logical volumes), ensure that the volume/disk group names on the application system and backup system are identical.

- On UNIX, ensure that the following users exist on the application system:
 - `oraORACLE_SID` with the primary group `dba`
 - `ORACLE_SIDadm` in the UNIX group `sapsys`
- The SAP R/3 software must be correctly installed on the application system. The following is a list of standard directories that must be installed on the application system after installing SAP R/3:

 **NOTE:**

The location of the directories depends on the environment variables. Refer to the SAP R/3 documentation for more information.

- `ORACLE_HOME/dbs` - the Oracle and SAP R/3 profiles
- `ORACLE_HOME/bin` - the Oracle binaries
- `SAPDATA_HOME/sapbackup` - the SAPBACKUP directory with BRBACKUP log files
- `SAPDATA_HOME/saparch` - the SAPARCH directory with BRARCHIVE log files
- `SAPDATA_HOME/sapreorg`
- `SAPDATA_HOME/sapcheck`
- `SAPDATA_HOME/saptrace`
- `/usr/sap/ORACLE_SID/SYS/exe/run`

 **NOTE:**

If you plan to do instant recovery, ensure that the `sapbackup`, `saparch`, and `sapreorg` directories reside on different source volumes than the Oracle data files.

If the last six directories do not reside at the above specified destinations, create appropriate links to them.

The directory `/usr/sap/ORACLE_SID/SYS/exe/run` must be owned by the UNIX user `oraORACLE_SID`. The owner of the SAP R/3 files must be the UNIX user `oraORACLE_SID` and the UNIX group `dba` with `setuid` bit set (`chmod 4755 ...`). The exception is the file `BRRESTORE`, which must be owned by the UNIX user `ORACLE_SIDadm`.

Example

If `ORACLE_SID` is `PRO`, then the permissions inside the directory `/usr/sap/PRO/SYS/exe/run` should look like:

```
-rwsr-xr-x  1 orapro dba 4598276 Apr 17  1998 brarchive
-rwsr-xr-x  1 orapro dba 4750020 Apr 17  1998 brbackup
-rwsr-xr-x  1 orapro dba 4286707 Apr 17  1998 brconnect
-rwsr-xr-x  1 proadm sapsys 430467 Apr 17  1998 brrestore
-rwsr-xr-x  1 orapro dba 188629 Apr 17  1998 brtools
```

Installation procedure

1. Install SAP R/3 BRTOOLS on the application system.
2. Install the following Data Protector software components on both the application system and backup system:
 - EMC Symmetrix Agent
 - SAP R/3 Integration
 - Disk Agent

 **NOTE:**

You do not need to install SAP R/3 Integration on the backup system if you plan to run `BRBACKUP` only on the application system.

EMC Symmetrix Integration with Microsoft SQL Server

Prerequisite

Microsoft SQL Server has to be installed on the application system. User databases *must* reside on the disk array source volumes, while system databases can be installed anywhere. However, if the system databases are also installed on the disk array, they *must* be installed on *different* source volumes than user databases.

Installation procedure

Install the following Data Protector software components on both the application and the backup systems:

- EMC Symmetrix Agent
- MS SQL Integration

HP StorageWorks Disk Array XP integration

To integrate HP StorageWorks Disk Array XP with Data Protector, install the following Data Protector software components on the application and backup systems:

- HP StorageWorks XP Agent
- General Media Agent

Install the `General Media Agent` component on the backup system to back up the bulk data. Install it on the application system to back up archive logs or to perform a restore to the application system.

- Disk Agent

Install the `Disk Agent` component on the application and backup systems to run disk image and filesystem ZDB. Clients without Disk Agent installed are not listed in the `Application system` and `Backup system` drop-down lists when creating a ZDB specification.

Installing in a cluster

You can install the HP StorageWorks Disk Array XP integration in a cluster environment. For the supported cluster configurations and specific installation requirements, see *HP Data Protector zero downtime backup administrator's guide*.

Integrating with other applications

If you want to install the HP StorageWorks XP integration with a database application, install the Data Protector component specific for the particular integration to the application and backup systems and perform the installation tasks specific for this integration. You can install the HP StorageWorks Disk Array XP integration with Oracle, SAP R/3, Microsoft Exchange Server, Microsoft SQL Server, and Microsoft VSS.

HP StorageWorks Disk Array XP integration with Oracle

Prerequisites

- The following software must be installed and configured on the application system and on the backup system for the backup set ZDB method:

- Oracle Enterprise Server (RDBMS)
- Oracle Net services
- SQL*Plus

The Oracle software on the backup system must be installed in the same directory as on the application system. The binaries should be identical to the binaries on the application system. You can achieve this either by copying the files and system environment from the application system to the backup system, or by a clean installation of the Oracle binaries on the backup system with the same installation parameters as on the application system.

- The Oracle data files on the application system must be installed on HP StorageWorks Disk Array XP LDEVs that are mirrored to the backup system.

In case of the backup set method, if some Oracle data files are installed on symbolic links, then these links have to be created on the backup system too.

Depending on the location of the Oracle control file, online redo log files, and Oracle9i/10g SPFILE, the following two options are possible:

- Oracle control file, online redo log files, and Oracle9i/10g SPFILE reside on a **different** volume group (if LVM is used) or source volume than Oracle datafiles.

By default, instant recovery is enabled for such configuration.

- Oracle control file, online redo log files, and Oracle9i/10g SPFILE reside on the **same** volume group (if LVM is used) or source volume as Oracle datafiles.

By default, instant recovery is *not* enabled for such configuration. You can enable instant recovery by setting the `ZDB_ORA_INCLUDE_CF_OLF`, `ZDB_ORA_INCLUDE_SPF`, and `ZDB_ORA_NO_CHECKCONF_IR` omnirc

variables. For more information, see the *HP Data Protector zero downtime backup integration guide*.

The Oracle archive redo log files do not have to reside on source volumes.

Installation procedure

Perform the following installation tasks:

1. Install the Oracle recovery catalog database.
See the Oracle documentation for information on how to install the Oracle recovery catalog database on the application system on non-mirrored disks. Leave the recovery catalog unregistered.
2. Install the following Data Protector software components:
 - HP StorageWorks XP Agent - on both the application and backup systems
 - Oracle Integration - if you want to use the backup set ZDB method, install this component on both the application and backup systems; if you want to use the proxy-copy ZDB method, install it on the application system only.

HP StorageWorks Disk Array XP integration with SAP R/3

Prerequisites

- The following Oracle software must be installed and configured on the application system:
 - Oracle Enterprise Server (RDBMS)
 - Oracle Net services
 - SQL *Plus
- If you plan to run SAP compliant ZDB sessions (BRBACKUP started on the backup system and not on the application system), correctly configure the backup system. For details, see the SAP database guide for Oracle (split mirror backup, software configuration).
- The database on the application system can be installed on disk images, logical volumes, or filesystems.
 - The Oracle datafiles *must* reside on a disk array.
 - For *online backup*, the control file and online redo logs do not have to reside on a disk array. *Online* SAP compliant ZDB sessions are an exception, for which the control file must reside on a disk array.

- For *offline backup*, the control file and online redo logs *must* reside on a disk array.
- Archived redo log files do not have to reside on a disk array.

If the Oracle control file, online redo logs, and Oracle SPFILE reside on the *same* LVM volume group or source volume as Oracle datafiles, set the Data Protector `ZDB_ORA_NO_CHECKCONF_IR`, `ZDB_ORA_INCLUDE_CF_OLF`, and `ZDB_ORA_INCLUDE_SPF_omnirc` variables. Otherwise, you cannot run ZDB-to-disk and ZDB-to-disk+tape sessions. For details, see the *HP Data Protector zero downtime backup integration guide*.

 **NOTE:**

If some of the Oracle data files are installed on symbolic links, create the links on the backup system too.

UNIX only: If the Oracle database is installed on raw partitions (rawdisk or raw logical volumes), ensure that the volume/disk group names on the application system and backup system are identical.

-
- On UNIX, ensure that the following users exist on the application system:
 - `oraORACLE_SID` with the primary group `dba`
 - `ORACLE_SIDadm` in the UNIX group `sapsys`
 - The SAP R/3 software must be correctly installed on the application system. The following is a list of standard directories that must be installed on the application system after installing SAP R/3:

 **NOTE:**

The location of the directories is dependent on the environment (UNIX systems) or registry (Windows system) variables. See the SAP R/3 documentation for more information.

-
- `ORACLE_HOME/dbs` (UNIX systems)
`ORACLE_HOME\database` (Windows systems) - the Oracle and SAP R/3 profiles)
 - `ORACLE_HOME/bin` or (UNIX systems)
`ORACLE_HOME\bin` (Windows systems) - the Oracle binaries
 - `SAPDATA_HOME/sapbackup` (UNIX systems)

- SAPDATA_HOME*\sapbackup (Windows systems) - the SAPBACKUP directory with BRBACKUP log files
- SAPDATA_HOME*/saparch (UNIX systems)
SAPDATA_HOME\saparch (Windows systems) - the SAPARCH directory with BRARCHIVE log files
- SAPDATA_HOME*/sapreorg (UNIX systems)
SAPDATA_HOME\sapreorg (Windows systems)
- SAPDATA_HOME*/sapcheck (UNIX systems)
SAPDATA_HOME\sapcheck (Windows systems)
- SAPDATA_HOME*/saptrace (UNIX systems)
SAPDATA_HOME\saptrace (Windows systems)
- /usr/sap/ORACLE_SID/SYS/exe/run* (UNIX systems)
c:\Oracle\ORACLE_SID\sys\exe\run (Windows systems)

 **NOTE:**

If you plan to do instant recovery, ensure that the *sapbackup*, *saparch*, and *sapreorg* directories reside on different source volumes than the Oracle data files.

UNIX systems

On UNIX systems, if the last six directories do not reside at the above specified destinations, create appropriate links to them.

On UNIX systems, the directory */usr/sap/ORACLE_SID/SYS/exe/run* must be owned by the UNIX user *oraORACLE_SID*. The owner of the SAP R/3 files must be the UNIX user *oraORACLE_SID* and the UNIX group *dba* with *setuid* bit set (*chmod 4755 ...*). The exception is the file *BRRESTORE*, which must be owned by the UNIX user *ORACLE_SIDadm*.

UNIX example

If *ORACLE_SID* is *PRO*, then the permissions inside the directory */usr/sap/PRO/SYS/exe/run* should look like:

```
-rwsr-xr-x  1 orapro dba 4598276 Apr 17  2007 brarchive
-rwsr-xr-x  1 orapro dba 4750020 Apr 17  2007 brbackup
```



```
-rwsr-xr-x 1 orapro dba 4286707 Apr 17 2007 brconnect
-rwsr-xr-x 1 proadm sapsys 430467 Apr 17 2007

brrestore
-rwsr-xr-x 1 orapro dba 188629 Apr 17 2007 brtools
```

Installation procedure

1. Install SAP R/3 BRTOOLS on the application system.
2. Install the following Data Protector software components on both the application system and backup system:
 - HP StorageWorks XP Agent
 - SAP R/3 Integration
 - Disk Agent

NOTE:

You do not need to install SAP R/3 Integration on the backup system if you plan to run BRBACKUP only on the application system.

On Windows systems, the Data Protector software components must be installed using the SAP R/3 administrator user account, and this account must be included in the `ORA_DBA` or `ORA_SID_DBA` local group on the system where the SAP R/3 instance is running.

HP StorageWorks Disk Array XP integration with Microsoft Exchange Server

Prerequisite

The Microsoft Exchange Server database must be installed on the application system on the HP StorageWorks Disk Array XP volumes (LDEVs), which are mirrored to the backup system. The mirroring can be BC or CA and the database installed on a filesystem. The following objects must be located on volumes that are mirrored:

- Microsoft Information Store (MIS)
- optionally, Key Management Service (KMS)
- optionally, Site Replication Service (SRS)

To be able to back up transaction logs, disable Circular Logging on the Microsoft Exchange Server.

Installation procedure

Install the following Data Protector software components:

- HP StorageWorks XP Agent - on both the application and the backup system
- MS Exchange Integration - on the application system only

HP StorageWorks Disk Array XP integration with Microsoft SQL Server

Prerequisite

Microsoft SQL Server has to be installed on the application system. User databases *must* reside on the disk array source volumes, while system databases can be installed anywhere. However, if the system databases are also installed on the disk array, they *must* be installed on *different* source volumes than user databases.

Installation procedure

Install the following Data Protector software components on both the application and the backup systems:

- HP StorageWorks XP Agent
- MS SQL Integration

HP StorageWorks Virtual Array integration

To integrate HP StorageWorks VA with Data Protector, install the following Data Protector software components to the application and backup systems:

- HP StorageWorks VA Agent
- General Media Agent

Install the General Media Agent component on the backup system to back up the bulk data. Install it on the application system to back up archive logs or to perform a restore to the application system.

- Disk Agent

Install the Disk Agent component on the application and backup systems to run disk image and filesystem ZDB. Clients without Disk Agent installed are not listed in the Application system and Backup system drop-down lists when creating a ZDB specification.

Installing in a cluster

You can install the HP StorageWorks VA integration in a cluster environment. For the supported cluster configurations and specific installation requirements, refer to the *HP Data Protector zero downtime backup administrator's guide*.

Integrating with other applications

If you want to install the HP StorageWorks VA integration with a database application, install the Data Protector component specific for the particular integration to the application and backup systems and perform the installation tasks specific for this integration. You can install the HP StorageWorks VA integration with Oracle, SAP R/3, Microsoft Exchange Server, and Microsoft SQL Server.

HP StorageWorks VA integration with Oracle

Prerequisites

- The following software must be installed and configured on the application system and on the backup system for the backup set ZDB method:
 - Oracle Enterprise Server (RDBMS)
 - Oracle Net services
 - SQL*Plus

The Oracle software on the backup system must be installed in the same directory as on the application system. The binaries should be identical to the binaries on the application system. You can achieve this either by copying the files and system environment from the application system to the backup system, or by a clean installation of the Oracle binaries on the backup system with the same installation parameters as on the application system.

- The Oracle database files used by the application system must be installed on the source volumes that will be replicated using the VA Agent (SNAPA).

Depending on the location of the Oracle control file, online redo log files, and Oracle9i/10g SPFILE, the following two options are possible:

- Oracle control file, online redo log files, and Oracle9i/10g SPFILE reside on a **different** volume group (if LVM is used) or source volume than Oracle datafiles.
By default, instant recovery is enabled for such configuration.
- Oracle control file, online redo log files, and Oracle9i/10g SPFILE reside on the **same** volume group (if LVM is used) or source volume as Oracle datafiles.

By default, instant recovery is *not* enabled for such configuration. You can enable instant recovery by setting the `ZDB_ORA_INCLUDE_CF_OLF`, `ZDB_ORA_INCLUDE_SPF_OLF`, and `ZDB_ORA_NO_CHECKCONF_IR` variables. For more information, see the *HP Data Protector zero downtime backup integration guide*.

The Oracle archive redo log files do not have to reside on source volumes.

Installation procedure

Perform the following installation tasks:

1. Install the Oracle recovery catalog database.

Refer to Oracle documentation for information on how to install the Oracle recovery catalog database on the application system. Leave the recovery catalog unregistered.

2. Install the following Data Protector software components:

- `HP StorageWorks VA Agent` - on both the application and backup systems
- `Oracle Integration` - if you want to use the backup set ZDB method, install this component on both the application and backup systems; if you want to use the proxy-copy ZDB method, install it on the application system only.

HP StorageWorks VA integration with SAP R/3

Prerequisites

- The following Oracle software must be installed on the application system:
 - Oracle Enterprise Server (RDBMS)
 - Oracle Net services
 - SQL *Plus
- If you plan to run SAP compliant ZDB sessions (BRBACKUP started on the backup system and not on the application system), correctly configure the backup system. For details, see the SAP database guide for Oracle (split mirror backup, software configuration).
- The database on the application system can be installed on disk images, logical volumes, or filesystems.
 - The Oracle datafiles *must* reside on a disk array.

- For *online backup*, the control file and online redo logs do not have to reside on a disk array. *Online SAP compliant ZDB sessions* are an exception, for which the control file must reside on a disk array.
- For *offline backup*, the control file and online redo logs *must* reside on a disk array.
- Archived redo log files do not have to reside on a disk array.

If the Oracle control file, online redo logs, and Oracle SPFILE reside on the *same* LVM volume group or source volume as Oracle datafiles, set the Data Protector ZDB_ORA_NO_CHECKCONF_IR, ZDB_ORA_INCLUDE_CF_OLF, and ZDB_ORA_INCLUDE_SPF omnirc variables. Otherwise, you cannot run ZDB-to-disk and ZDB-to-disk+tape sessions. For details, see the *HP Data Protector zero downtime backup integration guide*.

 **NOTE:**

If some of the Oracle data files are installed on symbolic links, create the links on the backup system too.

UNIX only: If the Oracle database is installed on raw partitions (rawdisk or raw logical volumes), ensure that the volume/disk group names on the application system and backup system are identical.

-
- On UNIX, ensure that the following users exist on the application system:
 - oraORACLE_SID with the primary group dba
 - ORACLE_SIDadm in the UNIX group sapsys
 - The SAP R/3 software must be correctly installed on the application system. The following is a list of standard directories that must be installed on the application system after installing SAP R/3:

 **NOTE:**

The location of the directories is dependent on the environment (UNIX systems) or registry (Windows system) variables. Refer to the SAP R/3 documentation for more information.

-
- ORACLE_HOME/dbs (UNIX systems)
ORACLE_HOME\database (Windows systems)
- the Oracle and SAP profiles)

- *ORACLE_HOME*/bin (UNIX systems)
ORACLE_HOME\bin (Windows systems)
- the Oracle binaries
- *SAPDATA_HOME*/sapbackup (UNIX systems)
SAPDATA_HOME\sapbackup (Windows systems)
- the SAPBACKUP directory with BRBACKUP log files
- *SAPDATA_HOME*/saparch (UNIX systems)
SAPDATA_HOME\saparch
(Windows systems) - the SAPARCH directory with BRARCHIVE log files
- *SAPDATA_HOME*/sapreorg (UNIX systems)
SAPDATA_HOME\sapreorg (Windows systems)
- *SAPDATA_HOME*/sapcheck (UNIX systems)
SAPDATA_HOME\sapcheck (Windows systems)
- *SAPDATA_HOME*/saptrace (UNIX systems)
SAPDATA_HOME\saptrace (Windows systems)
- /usr/sap/*ORACLE_SID*/SYS/exe/run (UNIX systems)
BRTOOLS (Windows systems)

 **NOTE:**

If you plan to do instant recovery, ensure that the *sapbackup*, *saparch*, and *sapreorg* directories reside on different source volumes than the Oracle data files.

UNIX systems

On UNIX systems, if the last six directories do not reside at the above specified destinations, create appropriate links to them.

On UNIX systems, the directory */usr/sap/ORACLE_SID/SYS/exe/run* must be owned by the UNIX user *oraORACLE_SID*. The owner of the SAP R/3 files must be the UNIX user *oraORACLE_SID* and the UNIX group *dba* with setuid bit set (*chmod 4755 ...*). The exception is the file *BRRESTORE*, which must be owned by the UNIX user *ORACLE_SIDadm*.

UNIX example

If `ORACLE_SID` is `PRO`, then the permissions inside the directory `/usr/sap/ORACLE_SID/SYS/exe/run` should look like:

```
-rwsr-xr-x 1 orapro dba 4598276 Apr 17 1998 brarchive
-rwsr-xr-x 1 orapro dba 4750020 Apr 17 1998 brbackup
-rwsr-xr-x 1 orapro dba 4286707 Apr 17 1998 brconnect
-rwsr-xr-x 1 proadm sapsys 430467 Apr 17 1998

brrestore
-rwsr-xr-x 1 orapro dba 188629 Apr 17 1998 brtools
```

Installation procedure

1. Install SAP R/3 BRTOOLS on the application system.
2. Install the following Data Protector software components on both the application system and backup system:
 - HP StorageWorks VA Agent
 - SAP R/3 Integration
 - Disk Agent



NOTE:

You do not need to install SAP R/3 Integration on the backup system if you plan to run BRBACKUP only on the application system.

On Windows systems, the Data Protector software components must be installed using the SAP R/3 administrator user account, and this account must be included in the `ORA_DBA` or `ORA_SID_DBA` local group on the system where the SAP R/3 instance is running.

HP StorageWorks VA integration with Microsoft Exchange Server

Prerequisite

The Microsoft Exchange Server database must be installed on the application system source volumes. The following objects must be located on source volumes:

- Microsoft Information Store (MIS)
- optionally, Key Management Service (KMS)
- optionally, Site Replication Service (SRS)

To be able to back up transaction logs, disable Circular Logging on the Microsoft Exchange Server.

Installation procedure

Install the following Data Protector software components:

- HP StorageWorks VA Agent - on both the application and the backup system
- MS Exchange Integration - on the application system only

HP StorageWorks VA integration with Microsoft SQL Server

Prerequisite

Microsoft SQL Server has to be installed on the application system. User databases *must* reside on the disk array source volumes, while system databases can be installed anywhere. However, if the system databases are also installed on the disk array, they *must* be installed on *different* source volumes than user databases.

Installation procedure

Install the following Data Protector software components on both the application and the backup systems:

- HP StorageWorks VA Agent
- MS SQL Integration

HP StorageWorks Enterprise Virtual Array integration

To integrate HP StorageWorks EVA with Data Protector, install the following Data Protector software components on the application and backup systems:

- HP StorageWorks EVA SMI-S Agent
- General Media Agent

Install the General Media Agent component on the backup system to back up the bulk data. Install it on the application system to back up archive logs or to perform a restore to the application system.

- Disk Agent

Install the Disk Agent component on the application and backup systems to run disk image and filesystem ZDB. Clients without Disk Agent installed are not listed in the Application system and Backup system drop-down lists when creating a ZDB specification.

Installing in a cluster

You can install the HP StorageWorks EVA integration in a cluster environment. For the supported cluster configurations and specific installation requirements, see the *HP Data Protector zero downtime backup administrator's guide*.

Integrating with other applications

To install the HP StorageWorks EVA integration with a database application, install the Data Protector component specific for the particular integration to the application and backup systems and perform the installation tasks specific for this integration. You can install the HP StorageWorks EVA integration with Oracle, SAP R/3, Microsoft Exchange Server, Microsoft SQL Server, and Microsoft VSS.

HP StorageWorks EVA integration with Oracle

Prerequisites

- The following software must be installed and configured on the application system and on the backup system for the backup set ZDB method:
 - Oracle Enterprise Server (RDBMS)
 - Oracle Net services
 - SQL*Plus

The Oracle software on the backup system must be installed in the same directory as on the application system. The binaries should be identical to the binaries on the application system. You can achieve this either by copying the files and system environment from the application system to the backup system, or by a clean installation of the Oracle binaries on the backup system with the same installation parameters as on the application system.

- The Oracle datafiles on the application system must be installed on source volumes that will be replicated using the SMI-S agent you have installed.

Depending on the location of the Oracle control file, online redo log files, and Oracle9i/10g SPFILE, the following two options are possible:

- Oracle control file, online redo log files, and Oracle9i/10g SPFILE reside on a **different** volume group (if LVM is used) or source volume than Oracle datafiles.
By default, instant recovery is enabled for such configuration.
- Oracle control file, online redo log files, and Oracle9i/10g SPFILE reside on the **same** volume group (if LVM is used) or source volume as Oracle datafiles.

By default, instant recovery is *not* enabled for such configuration. You can enable instant recovery by setting the `ZDB_ORA_INCLUDE_CF_OLF`, `ZDB_ORA_INCLUDE_SPF`, and `ZDB_ORA_NO_CHECKCONF_IR_omnirc` variables. For more information, see the *HP Data Protector zero downtime backup integration guide*.

The Oracle archive redo log files do not have to reside on source volumes.

If some Oracle data files are installed on symbolic links, then these links have to be created on the backup system too.

Installation procedure

Perform the following installation tasks:

1. Install the Oracle recovery catalog database.

See the Oracle documentation for information on how to install the Oracle recovery catalog database on the application system on non-mirrored disks. Leave the recovery catalog unregistered.

2. Install the following Data Protector software components:

- HP StorageWorks EVA SMI-S Agent - on both the application and backup systems
- Oracle Integration - if you want to use the backup set ZDB method, install this component on both the application and backup systems; if you want to use the proxy-copy ZDB method, install it on the application system only.

HP StorageWorks EVA integration with SAP R/3

Prerequisites

- The following Oracle software must be installed on the application system.
 - Oracle Enterprise Server (RDBMS)
 - Oracle Net services
 - SQL*Plus
- If you plan to run SAP compliant ZDB sessions (BRBACKUP started on the backup system and not on the application system), correctly configure the backup system. For details, see the SAP database guide for Oracle (split mirror backup, software configuration).
- The database on the application system can be installed on disk images, logical volumes, or filesystems.

- The Oracle datafiles *must* reside on a disk array.
- For *online backup*, the control file and online redo logs do not have to reside on a disk array. *Online SAP* compliant ZDB sessions are an exception, for which the control file must reside on a disk array.
- For *offline backup*, the control file and online redo logs *must* reside on a disk array.
- Archived redo log files do not have to reside on a disk array.

If the Oracle control file, online redo logs, and Oracle SPFILE reside on the *same* LVM volume group or source volume as Oracle datafiles, set the Data Protector ZDB_ORA_NO_CHECKCONF_IR, ZDB_ORA_INCLUDE_CF_OLF, and ZDB_ORA_INCLUDE_SPF omnirc variables. Otherwise, you cannot run ZDB-to-disk and ZDB-to-disk+tape sessions. For details, see the *HP Data Protector zero downtime backup integration guide*.

 **NOTE:**

If some of the Oracle data files are installed on symbolic links, create the links on the backup system too.

UNIX only: If the Oracle database is installed on raw partitions (rawdisk or raw logical volumes), ensure that the volume/disk group names on the application system and backup system are identical.

-
- On UNIX, ensure that the following users exist on the application system:
 - oraORACLE_SID with the primary group dba
 - ORACLE_SIDadm in the UNIX group sapsys
 - The SAP R/3 software must be correctly installed on the application system. The following is a list of standard directories that must be installed on the application system after installing SAP R/3:

 **NOTE:**

The location of the directories is dependent on the environment (UNIX systems) or registry (Windows system) variables. Refer to the SAP R/3 documentation for more information.

-
- ORACLE_HOME/dbs (UNIX systems) ORACLE_HOME\database (Windows systems) - the Oracle and SAP profiles)

- *ORACLE_HOME/bin* (UNIX systems) *ORACLE_HOME\bin* (Windows systems)
- the Oracle binaries
- *SAPDATA_HOME/sapbackup* (UNIX systems) *SAPDATA_HOME\sapbackup*
(Windows systems) - the SAPBACKUP directory with BRBACKUP log files
- *SAPDATA_HOME/saparch* (UNIX systems) *SAPDATA_HOME\saparch*
(Windows systems) - the SAPARCH directory with BRARCHIVE log files
- *SAPDATA_HOME/sapreorg* (UNIX systems) *SAPDATA_HOME\sapreorg*
(Windows systems)
- *SAPDATA_HOME/sapcheck* (UNIX systems) *SAPDATA_HOME\sapcheck*
(Windows systems)
- *SAPDATA_HOME/saptrace* (UNIX systems) *SAPDATA_HOME\saptrace*
(Windows systems)
- */usr/sap/ORACLE_SID/SYS/exe/run* (UNIX systems)
c:\Oracle\ORACLE_SID\sys\exe\run (Windows systems)

 **NOTE:**

If you plan to do instant recovery, ensure that the *sapbackup*, *saparch*, and *sapreorg* directories reside on different source volumes than the Oracle data files.

UNIX systems

On UNIX systems, if the last six directories do not reside at the above specified destinations, create appropriate links to them.

On UNIX systems, the directory */usr/sap/ORACLE_SID/SYS/exe/run* must be owned by the UNIX user *oraORACLE_SID*. The owner of the SAP R/3 files must be the UNIX user *oraORACLE_SID* and the UNIX group *dba* with setuid bit set (*chmod 4755 ...*). The exception is the file *BRRESTORE*, which must be owned by the UNIX user *ORACLE_SIDadm*.

UNIX example

If *ORACLE_SID* is *PRO*, then the permissions inside the directory */usr/sap/PRO/SYS/exe/run* should look like:

```
-rwsr-xr-x  1 orapro dba 4598276 Apr 17  2007 brarchive
-rwsr-xr-x  1 orapro dba 4750020 Apr 17  2007 brbackup
-rwsr-xr-x  1 orapro dba 4286707 Apr 17  2007 brconnect
-rwsr-xr-x  1 proadm sapsys 430467 Apr 17  2007
```

```
brrestore
-rwsr-xr-x  1 orapro dba 188629 Apr 17  2007 brtools
```

Installation procedure

1. Install SAP R/3 BRTOOLS on the application system.
2. Install the following Data Protector software components on both the application system and backup system:
 - HP StorageWorks EVA SMI-S Agent
 - SAP R/3 Integration
 - Disk Agent

NOTE:

You do not need to install SAP R/3 Integration on the backup system if you plan to run BRBACKUP only on the application system.

On Windows systems, the Data Protector software components must be installed using the SAP R/3 administrator user account, and this account must be included in the `ORA_DBA` or `ORA_SID_DBA` local group on the system where the SAP R/3 instance is running.

HP StorageWorks EVA integration with Microsoft Exchange Server

Prerequisite

The Microsoft Exchange Server database must be installed on the application system source volumes. The following objects must be located on the source volumes:

- Microsoft Information Store (MIS)
- optionally, Key Management Service (KMS)
- optionally, Site Replication Service (SRS)

To be able to back up transaction logs, disable Circular Logging on the Microsoft Exchange Server.

Installation procedure

Install the following Data Protector software components:

- HP StorageWorks EVA SMI-S Agent on both the application and backup systems

- MS Exchange Integration - on the application system only

HP StorageWorks EVA integration with MS SQL

Prerequisite

Microsoft SQL Server has to be installed on the application system. User databases *must* reside on the disk array source volumes, while system databases can be installed anywhere. However, if the system databases are also installed on the disk array, they *must* be installed on *different* source volumes than user databases.

Installation procedure

Install the following Data Protector software components on both the application and the backup systems:

- HP StorageWorks EVA SMI-S Agent on both the application and backup systems
- MS SQL Integration

Installing the Data Protector IAP components

The Data Protector integration with HP Integrated Archive Platform (IAP) provides the data backup directly to the IAP appliance. This solution takes advantage of the powerful IAP capabilities, such as the ability of holding many terabytes of data, eliminating redundancies in the stored data, advanced search tools and reliable and fast single file point-in-time restores.

To integrate IAP with Data Protector, install the following Data Protector software components on the client system:

- IAP Disk Agent Extension
- IAP Deduplication Agent

Prerequisites

Before starting the installation, perform the following steps on the IAP:

1. Set up the Domain Account Synchronization (DAS) to connect the IAP to Microsoft Active Directory. Import to the IAP a subset of domain users who will then be able to access the IAP. For detailed information, see the Reference Information Manager for Files documentation.

2. Add the user who will run IAP backups to the application users group on the IAP:

```
/opt/rimf/rimfcreate appuser account_name [-d |  
--description description] password
```

To verify if a particular user is part of the application users group, run:

```
/opt/rimf/rimflist appusers
```

3. Register the system to be used for backups. For Data Protector backups, this is done by importing the IAP Server to the cell. Before this is done, the IAP must have a registration rule, which is a pattern that needs to match to the system registered. To do this, execute:

```
/opt/rimf/rimfcreate regrule rule_name [-h | --hostdns  
dns-regex] [-n | --network network_address]  
riss_domain_name, for example:
```

```
/opt/rimf/rimfcreate regrule testRule -h  
test.*\mydomain\.com$ d2riss
```

The above example allows to register the systems with the names starting with test and located in mydomain.com. The system is registered and the AIP assigns a client ID to it. If the system is not registered, backups using Data Protector will fail. To verify that the registration rule is created, run:

```
/opt/rimf/rimflist regrules
```

For further information, see the *Reference Information Manager for Files user guide*.

In addition, upload the certificate for accessing the IAP appliance to the Cell Manager and import at least one IAP Server to the Data Protector cell.

Installing the Data Protector VLS automigration components

The Data Protector media copy functionality allows you to copy media after performing a backup. The integration with the HP StorageWorks Virtual Library System (VLS) enhances this functionality by providing a solution that combines the internal VLS copy capabilities with the Data Protector media management and monitoring functionality.

To integrate Data Protector with VLS automigration to perform smart media copying, install the VLS Automigration Data Protector software component.

Prerequisites

Perform the following steps:

1. Configure the VLS virtual storage as required using the Command View VLS. See the VLS documentation for more information.
2. Connect one or more physical tape libraries to the VLS.
3. Import the VLS client to the Data Protector cell.

Installing localized Data Protector user interface

Data Protector A.06.10 provides a localized Data Protector user interface on Windows and UNIX systems. This consists of the localized Data Protector GUI and CLI. Localized online Help and printed documentation is also provided. For more information on which Data Protector manuals are localized, refer to the *HP Data Protector product announcements, software notes, and references*.



NOTE:

By default, during the Data Protector installation, the English language support is installed. When you install an additional language support, the localized Data Protector user interface is started according to the locale environment set on the system.

Installing localized Data Protector user interface on Windows systems

Local installation

To install the localized Data Protector user interface on Windows systems, select the appropriate language support (French or Japanese) in the **Custom Setup** page of the **Setup** wizard, as shown on [Figure 24](#) on page 185.

For the local installation procedure, refer to “[Installing the Data Protector Cell Manager \(CM\) and Installation Server\(s\) \(IS\)](#)” on page 42.

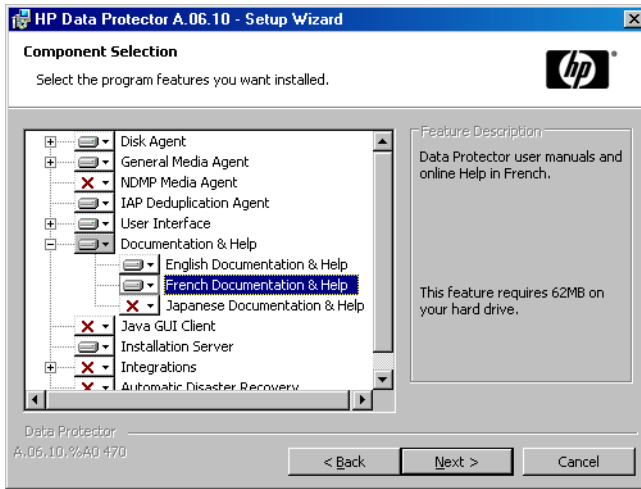

Figure 24 Selecting language support at setup

Remote installation

When distributing the Data Protector language support remotely using the Installation Server, select the appropriate language support in the **Component Selection** page of the **Add Components** wizard, as shown on [Figure 25](#) on page 186.

For the procedure on how to remotely add the Data Protector software components to clients, refer to “[Remote installation of Data Protector clients](#)” on page 77.

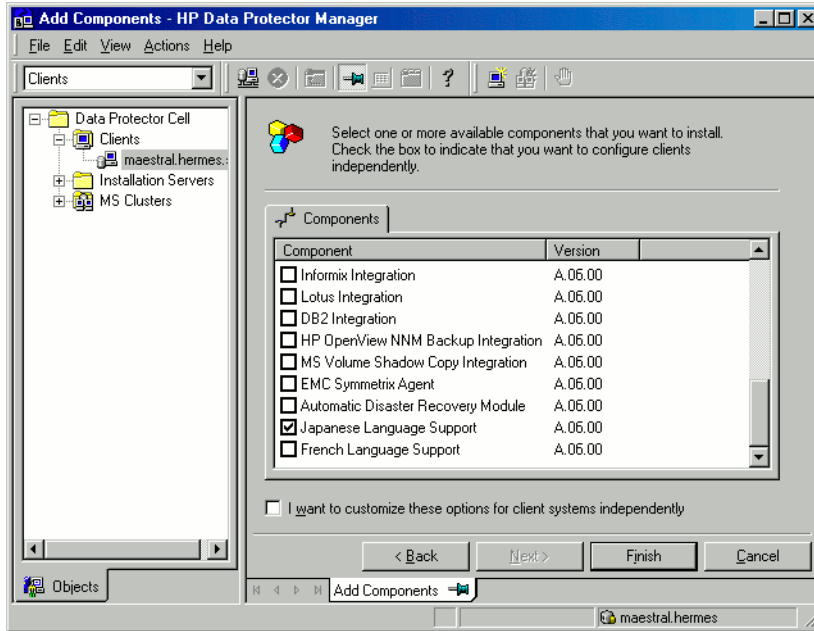

Figure 25 Installing language support remotely

Installing localized Data Protector user interface on UNIX systems

Local installation

You can install the Japanese or French language support locally only on a Data Protector client using the `omnisetup.sh` command. Specify the `jpn_ls` or `fra_ls` software components depending on the language support you need. For the detailed procedure, refer to “[Local installation of UNIX clients](#)” on page 146.

If you are using the `swinstall`, `pkgadd`, or `rpm` utility to install the Data Protector Cell Manager or Installation Server, you can only install the English language support. If you want the localized Data Protector user interface to reside on the same system with the Cell Manager or Installation Server, you need to install the additional language support remotely.

Remote installation

When distributing the Data Protector language support remotely using the Installation Server, select the appropriate language support in the **Component Selection** page of the **Add Components** wizard, as shown on [Figure 25](#) on page 186.

For the procedure on how to remotely add the Data Protector software components to clients, refer to “[Remote installation of Data Protector clients](#)” on page 77.

Troubleshooting

If the English Data Protector user interface is started after you installed a different language support, verify the following:

1. Check that the following files exist:

For French Language Support:

- On Windows: `Data_Protector_home\bin\OmniFra.dll`
- On HP-UX: `/opt/omni/lib/nls/fr.iso88591/omni.cat`
- On Solaris: `/opt/omni/lib/nls/fr.ISO8859-1/omni.cat`

For Japanese Language Support:

- On Windows: `Data_Protector_home\bin\OmniJpn.dll`
- On HP-UX: `/opt/omni/lib/nls/ja.eucJP/omni.cat` and `/opt/omni/lib/nls/ja.SJIS/omni.cat`
- On Solaris: `/opt/omni/lib/nls/ja.eucJP/omni.cat` and `/opt/omni/lib/nls/ja.PCK/omni.cat`

2. Check the locale environment settings on your system:

- On Windows: In the Windows Control Panel, click Regional Options and check that you have an appropriate language selected in locale and language settings.

- On UNIX: Run the following command to set the locale environment:

```
export LANG=lang locale
```

where *lang* represents the locale environment setting in the following format: `language[_territory].codeset`.

For example, `ja_JP.eucJP`, `ja_JP.SJIS`, or `ja_JP.PCK` for Japanese locale; and `fr_FR.iso88591` for French locale. Note that the codeset part of the `LANG` variable is required and must match the codeset part of the corresponding directory name.

Installing the Data Protector Single Server Edition

The Single Server Edition (SSE) of Data Protector is designed for small environments where backups run on only one device connected to a Cell Manager. It is available for supported Windows and for HP-UX and Solaris platforms.

To install the Cell Manager and (optionally) Installation Server, follow the instructions in [“Installing the Data Protector Cell Manager \(CM\) and Installation Server\(s\) \(IS\)”](#) on page 42.

Limitations

When considering the SSE license, be aware of the following limitations:

Limitations of SSE for Windows

- SSE supports backups to only one device concurrently, connected to a single Cell Manager.
- One 10-slot DDS autochanger only is supported.
- UNIX (also HP-UX) clients and servers are not supported. If a backup is attempted to a UNIX machine, the session is aborted.
- If a cell has a Windows Cell Manager, you can back up only Windows clients. Backup to Novell Netware clients is not supported.
- Adding extension products is not supported with SSE.
- Clustering is not supported with SSE.
- Disaster Recovery is not supported with SSE.

The number of Windows clients is not limited.

For supported devices, please refer to the HP Data Protector product announcements, software notes, and references.

Limitations of SSE for HP-UX and Solaris

- SSE supports backups to only one device concurrently, connected to a single Cell Manager.
- One 10-slot DDS autochanger only is supported.
- On a UNIX Cell Manager, you cannot back up servers - only UNIX clients, Windows clients, Solaris clients, and Novell NetWare clients.
- Adding extension products is not supported with SSE.
- Clustering is not supported with SSE.

The number of clients (UNIX, Windows) is not limited.

For supported devices, please refer to the HP Data Protector product announcements, software notes, and references.

Installing a password

For the step-by-step instructions on how to install a password on the Cell Manager, refer to “[Data Protector passwords](#)” on page 322.

Installing Data Protector web reporting

Data Protector Web Reporting is installed with other Data Protector components by default, and as such, you can use it locally from your system.

You can also install it on a Web server and in that way make it available on other systems which do not need to have any of the Data Protector software components installed.

Prerequisites

To use Data Protector Web Reporting on your system, refer to the *HP Data Protector product announcements, software notes, and references* for prerequisites and limitations.

Installation

To install Data Protector Web Reporting to a Web server, do the following:

1. Copy the following Data Protector Java reporting files to the server. The server does not have to be a Data Protector client.
 - On Windows systems with the Data Protector user interface installed, the files are located in the following directory:
`Data_Protector_home\java\bin`
 - On a UNIX system with the Data Protector user interface installed, the files are located in the following directory:
`/opt/omni/java/bin`
2. Open the `WebReporting.html` file in your browser to access the Data Protector Web Reporting.

You must make the file available to the users of the Web reporting in the full URL form. For example, you can put a link to this file from your Intranet site.

 **TIP:**

By default, no password is needed to use Data Protector Web Reporting. You can provide one and in that way restrict the access to the Web reporting. For the procedure, refer to the online Help index: “Web reports, limiting access to”.

What's next?

When the installation has been completed, refer to the online Help index: “Web reporting interface, configuring notifications” for more information on configuration issues and creating your own reports.

Installing Data Protector on MC/ServiceGuard

Data Protector supports MC/ServiceGuard (MC/SG) for HP-UX and Linux. For details on supported operating system versions, refer to the *HP Data Protector product announcements, software notes, and references*.

If your Cell Manager is to be cluster-aware, note that the virtual server IP address should be used for licenses.

Installing a cluster-aware Cell Manager

Prerequisites

Before you install a Data Protector Cell Manager on MC/ServiceGuard, check the following:

- Decide which systems are going to be the Primary Cell Manager and the Secondary Cell Manager(s). All of them must have MC/ServiceGuard installed and must be configured as cluster members.
- Data Protector Cell Manager, with recommended patches, and all other Data Protector software components for the integrations you want to have in the cluster, must be installed on the Primary node and each of the Secondary nodes.

The installation procedure is standard procedure for installing the Cell Manager system. See the

[“Installing the Data Protector Cell Manager \(CM\) and Installation Server\(s\) \(IS\)”](#) on page 42.

What's next?

When the installation has been completed, you must configure the installed Primary Cell Manager and the Secondary Cell Manager(s), and the Cell Manager package. Refer to the online Help index: "cluster, MC/ServiceGuard" for more information on configuring MC/ServiceGuard with Data Protector.

Installing a cluster-aware client

IMPORTANT:

The Data Protector cluster-aware clients must be installed on all the cluster nodes.

The installation procedure is standard procedure for installing Data Protector on an UNIX client. Refer to "Installing HP-UX clients" on page 93 and "Installing Linux clients" on page 103 for detailed instructions.

What's next?

When the installation has been completed, you must import the virtual server (the hostname specified in the cluster package) to the Data Protector cell. See "Importing a cluster-aware client to a cell " on page 210.

Refer to the *online Help index*: "configuration" for more information on how to configure backup devices, media pools, or any additional Data Protector configuration tasks.

Installing Data Protector on Microsoft Cluster Server

For supported operating systems for Microsoft Cluster Server integration, see the <http://www.hp.com/support/manuals>.

If your Cell Manager is to be cluster-aware, note that the virtual server IP address should be used for licenses.

Installing a cluster-aware Cell Manager

Prerequisites

Before you install the cluster-aware Cell Manager, make sure that you do not have resources with the following names on the cluster:

OBVS_MCRS, OBVS_VELOCIS, OmniBack_Share

If they exist and you are performing a new installation (not an upgrade), delete or rename these resources, because Data Protector uses those names for the Data Protector virtual server.

This can be done as follows:

1. Click **Start > Programs > Administrative Tools > Cluster Administrator**.
2. Check the resource list and delete or rename these resources, if necessary.

To properly install and configure Data Protector in a Microsoft Cluster Server environment, you must provide a domain account with the appropriate user rights:

- Administrator rights on the Cell Manager
- Cluster Administrator rights within the cluster
- Password Never Expires
- Logon as a service
- User Cannot Change Password
- All logon hours are allowed

 **NOTE:**

When you are installing a Data Protector Cell Manager as cluster-aware in a Microsoft Cluster environment, the Data Protector User Account must be a domain user account, which has all of the above mentioned user rights.

 **TIP:**

An account with administrator rights on all the cluster systems is required for a Cluster Server installation. It is recommended that you use this account to install Data Protector as well. Invalid user rights may result in Data Protector services running in the standard, instead of the cluster-aware, mode.

Before you start installing the Cell Manager software on a cluster, check the requirements:

- A cluster must be installed properly with all of its functionality. For example, you must be able to move groups from one to another node as many times as needed, with no problems with shared disk(s).

- At least one group in the cluster should have a *File Share* resource defined. Data Protector will install its database components on this *File Share* resource. Refer to the cluster specific documentation in order to define *File Share* resource. Note that the file share name of the *File Share* resource cannot be OmniBack.
- If the virtual server does not exist in the same group as the *File Share* resource group, a new virtual server must be created using a free registered IP address and associating a network name with it.
- The *File Share* resource where Data Protector is to be installed must have the *IP Address*, *Network Name*, and *Physical Disk* set among the *File Share* dependencies. This is necessary to ensure that Data Protector cluster group will be able to run on any node independently of any other group.
- Ensure that only the cluster administrator has access to the *File Share* resource and that he has full access to it.
- Each system of the cluster should be up and running properly.
- If a system in the cluster has the Data Protector software installed as non-cluster-aware, you need to uninstall it prior to the setup. The upgrade option is supported only if the already installed Data Protector software is the Cell Manager which was installed in a cluster-aware mode.
- Data Protector will be installed on the same location (drive and pathname) on all cluster nodes. Ensure that these locations are free.
- Other Microsoft Installer based installations must *not* be running on other cluster nodes.

Local installation

The Data Protector cluster-aware Cell Manager software must be installed locally, from the DVD-ROM. This can be done as follows:

1. Insert the Windows installation DV-ROM and run:

32-bit Windows (on x86 or AMD64/Intel EM64T):

`\Windows_other\i386\setup.exe`

64-bit Windows (on AMD64/Intel EM64T):

`\Windows_other\x8664\setup.exe`

The Data Protector Setup Wizard displays.

2. Follow the Setup Wizard and carefully read the license agreement. Click **Next** to continue, if you accept the terms of the agreement.

3. In the Installation Type page, select **Cell Manager** and then click **Next** to install Data Protector Cell Manager software.

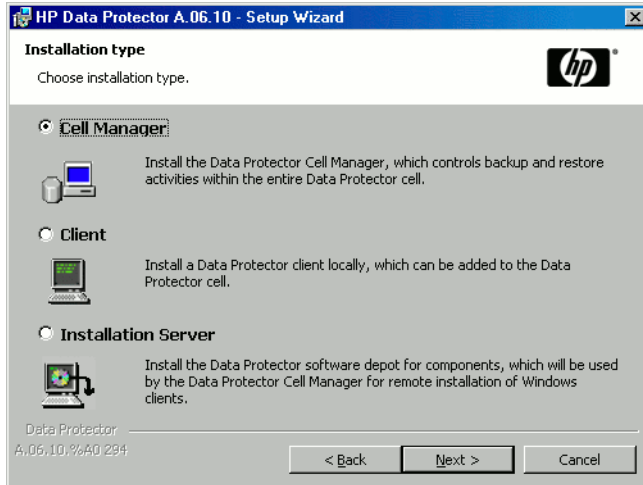

Figure 26 Selecting the installation type

4. Setup automatically detects that it is running in a cluster environment. Select **Install cluster-aware Cell Manager** to enable a cluster setup.

Select the cluster group, the virtual hostname, and the cluster *File Share* resource on which Data Protector shared files and the database will reside.

 **NOTE:**

If you select **Install Cell Manager on this node only**, the Cell Manager will *not* be cluster aware. Refer to [“Installing a Windows Cell Manager”](#) on page 52.

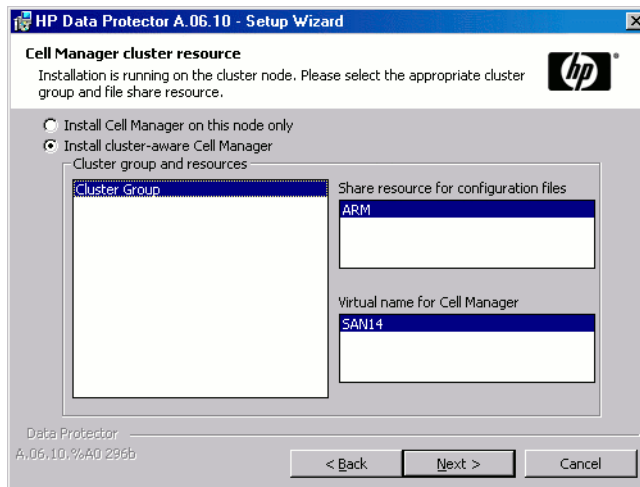

Figure 27 Selecting the cluster resource

5. Enter the username and password for the account that will be used to start Data Protector services.

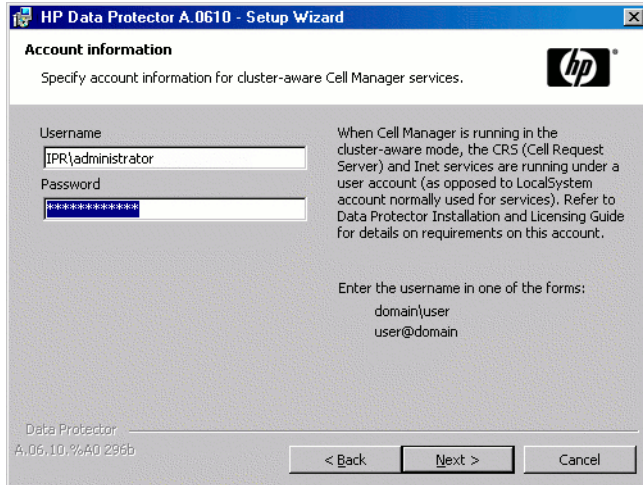

Figure 28 Entering the account information

6. Click **Next** to install Data Protector on the default folder.
Otherwise, click **Change** to open the Change Current Destination Folder window and enter a new path.

7. In the Component Selection window, select the components you want to install on all cluster nodes and cluster virtual servers. Click **Next**.

The MS Cluster Integration component is selected automatically.

The selected components will be installed on all the cluster nodes.

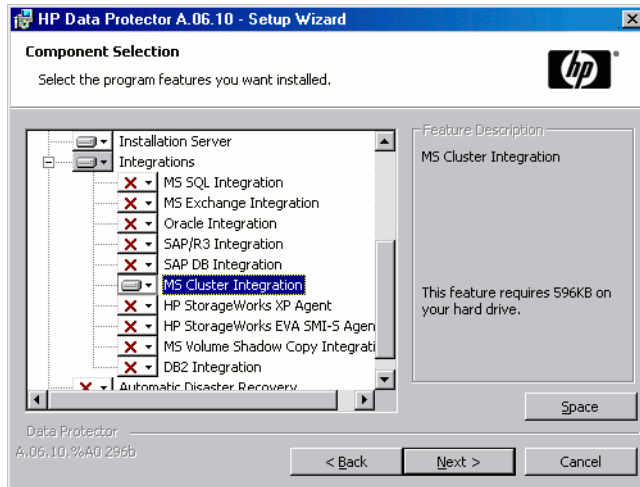

Figure 29 Component selection page

8. The component selection summary page is displayed. Click **Install**.

9. The Installation setup page is displayed. Click **Next**.

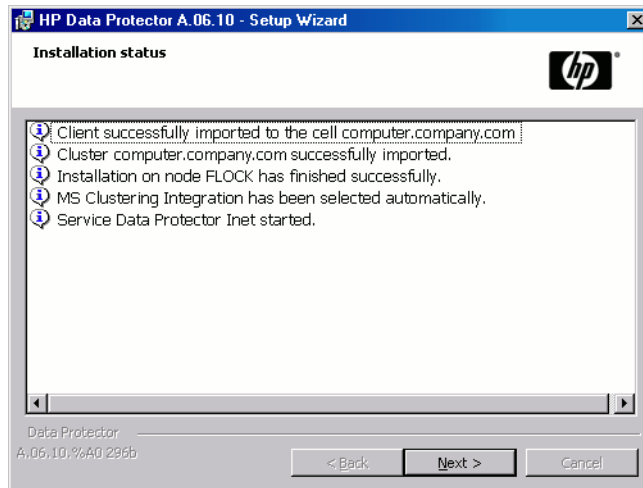

Figure 30 Installation status page

10. To start Data Protector immediately after install, select **Start the Data Protector Manager**.

To view the *HP Data Protector product announcements, software notes, and references*, select **Open the Product Announcements**.

*On operating systems other than 64-bit Windows (x64, IA-64), Windows Vista, and Windows Server 2008 TBD, to install or upgrade the HP AutoPass utility, select the **Start AutoPass installation** or the **Upgrade AutoPass installation** option.*

It is *not* recommended to install the HP AutoPass utility in Microsoft Cluster, because it will be installed only on the node used for the installation. If you did install AutoPass, you must uninstall Data Protector from the same node on which it was installed, when you decide to remove Data Protector from the system.

On Windows x64, Windows Vista, and Windows Server 2008 TBD operating systems, AutoPass is not installed.

Click **Finish** to complete the installation.

Checking the installation

When the setup procedure has been completed, you can check whether or not the Data Protector software has been properly installed. Proceed as follows:

1. Check if the Cluster service account is assigned to the Data Protector `Inet` service on each cluster node. Make sure the same user is also added to the Data Protector admin user group. The logon account type should be set to `This account` as shown in [Figure 31](#) on page 199 and .

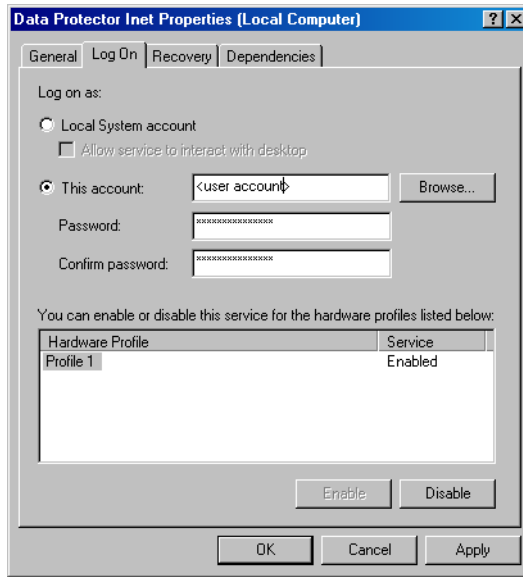

Figure 31 Data Protector user account

2. Switch to the `Data_Protector_home\bin` directory and run the following command:

```
omnirsh host INFO_CLUS
```

where `host` is the name of the cluster virtual server (case-sensitive). The output should list the names of the systems within the cluster and the name of virtual server. If the output returns 0 "NONE", Data Protector is not installed in the cluster-aware mode.

3. Start the Data Protector GUI, select the **Clients** context, and then click **MS Clusters**. You should see the newly installed systems listed in the Results Area.

Installing cluster-aware clients

Prerequisites

Before you install a cluster-aware Data Protector client, the following prerequisites must be fulfilled:

- A cluster must be installed properly with all of its functionality on all cluster nodes. For example, you must be able to move groups from one to another node as many times as needed, with no problems with shared disk(s).
- Each system of the cluster should be up and running properly.

Local installation

The Data Protector cluster-aware clients must be installed locally, from the DVD-ROM, on each cluster node. The cluster nodes (Data Protector cluster clients) are imported to the specified cell during the installation process. You will need then to import the virtual server name.

The cluster Administrator account is required to perform the installation. Apart from that, the cluster client setup is the same as for the Windows client setup. The Cluster Integration component, which is selected by default during the installation, must be installed in addition to Data Protector client components, such as Disk Agents and Media Agents.

See “[Installing Windows clients](#)” on page 86 for information on how to locally install a Data Protector Windows client system. Note that during the installation, Data Protector reports that a cluster was detected.

If you are installing the Data Protector Oracle integration, the setup procedure must be performed on all cluster nodes and on the virtual server of the Oracle resource group.



NOTE:

You can import a cluster-aware client to the Data Protector cell that is managed using either the standard Cell Manager or the cluster-aware Cell Manager.

Checking the installation

When the setup procedure has been completed, you can check whether or not the Data Protector software has been properly installed. Proceed as follows:

1. Check if the Cluster service account is assigned to the Data Protector `Inet` service on each cluster node. Make sure the same user is also added to the Data Protector `admin` user group. The logon account type should be set to **This account** as shown in [Figure 32](#) on page 201.

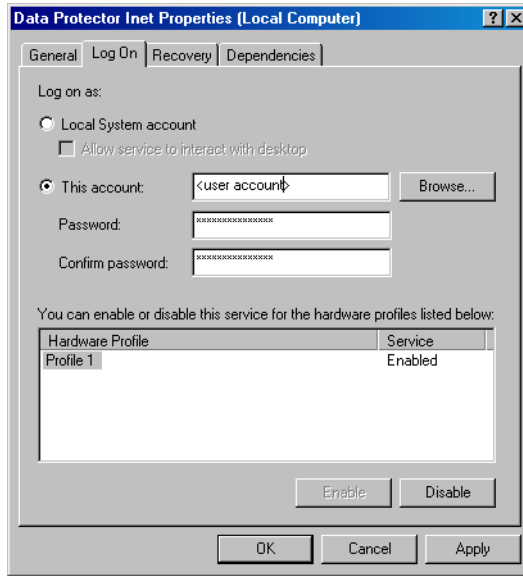

Figure 32 Data Protector user account

2. Switch to the `Data_Protector_home\bin` directory.
3. Run the following command:

```
omnirsh host INFO_CLUS
```

where `host` is the name of the cluster client system. The output should return the name of the cluster-aware client system. If the output returns 0 "NONE", Data Protector is not installed in the cluster-aware mode.

Veritas Volume Manager

If you have Veritas Volume Manager installed on the cluster, additional steps are required after you have completed the installation of Data Protector on Microsoft Cluster Server. See

["Installing Data Protector on Microsoft Cluster with Veritas Volume Manager"](#) on page 443, for the additional steps to be performed.

What's next?

When the installation has been completed, you must import the virtual server hostname (cluster-aware application) to the Data Protector cell. See [“Importing a cluster-aware client to a cell”](#) on page 210.

Refer to the online Help index: “configuring” for more information on how to configure backup devices, media pools, or any additional Data Protector configuration tasks.

Installing Data Protector clients on a Veritas Cluster

Data Protector clients can be installed on Veritas Cluster nodes, with a Cell Manager outside of the cluster. Using this configuration, backup of the local disks is supported.

Note that if you want to back up shared disks or cluster-aware applications, the virtual server IP address should be used for licenses.



IMPORTANT:

For Data Protector, cluster-aware backups with failover are not supported.

Installing a Client

The installation procedure is standard procedure for installing Data Protector on a Solaris client system. Refer to [“Installing Solaris clients”](#) on page 96 for detailed instructions.

What's next?

When the installation has been completed:

- If you want to back up the virtual server, you must import it into the cell.
- If you want to back up the physical nodes, you must also import them into the cell.

See [“Importing a cluster-aware client to a cell”](#) on page 210. Refer to the online Help index: “configuring” for more information on how to configure backup devices, media pools, or any additional Data Protector configuration tasks.

Installing Data Protector clients on a Novell NetWare Cluster

Data Protector clients can be installed on Novell NetWare Cluster Services cluster nodes, with a Cell Manager outside of the cluster. Using this configuration, backup of local disks is supported, as well as backup of shared cluster pools via the virtual server. For supported operating systems for Novell NetWare Cluster refer to the HP Data Protector product announcements, software notes, and references.

Note that if you want to back up shared disks or cluster-aware applications, the virtual server IP address should be used for licenses.

IMPORTANT:

Cluster-aware backups with failover are not supported. In case of failover, backup or restore sessions have to be restarted manually.

Backup devices should be configured on cluster nodes and not on the virtual server, because cluster nodes control the devices.

Installing a client

Before installation

Before installing Data Protector clients on Novell NetWare Cluster Services cluster nodes, it is recommended that you edit unload scripts for every virtual server in the cluster so that the secondary IP address remains active during the migration of the virtual server to another node. You can edit the unload scripts using the Novell's Console One utility or NetWare Remote Manager as described in the Novell NetWare documentation.

Example

The default unload script for every virtual server is:

```
del secondary ipaddress 10.81.1.173
CLUSTER CVSBIND DEL TREENW6_CLUSTER_FIRST_SERVER 10.81.1.173
NUDP DEL TREENW6_CLUSTER_FIRST_SERVER 10.81.1.173
nss /pooldeactivate=FIRST /overridetype=question
```

The modified unload script for every virtual server is:

```
nss /pooldeactivate=FIRST /override=question
del secondary ipaddress 10.81.1.173
CLUSTER CVSBIND DEL TREENW6_CLUSTER_FIRST_SERVER 10.81.1.173
NUDP DEL TREENW6_CLUSTER_FIRST_SERVER 10.81.1.173
```

The modified unload script will first dismount and deactivate all cluster shared pools on the virtual server, and only then will delete the secondary IP address. This means that the secondary IP address will remain active during the migration.

To activate the modified unload script, put the virtual server offline and then back online on the preferred node.

Editing the smsrun.bas script

After you have edited the unload script(s), you have to edit the `smsrun.bas` script to include loading of the `TSA600.NLM` module (or `TSAFS.NLM` - depending on which module you are using) with the appropriate parameter which disables support for the cluster. For more information, refer to the Novell Support Knowledge database for "Known Backup/Restore Issues for NetWare 6.x".

Perform the following steps to edit the `smsrun.bas` script:

1. Change the write protection for the `SYS:NSN/user/smsrun.bas` script from read only to read/write and open it in a standard console editor.
2. Change the `nlmArray = Array("SMDR", "TSA600", "TSAPROXY")` (or `nlmArray = Array("SMDR", "TSAFS /NoCluster")`) line in the `Sub Main()` section to:
 - `nlmArray = Array("SMDR", "TSA600 /cluster=off", "TSAPROXY")` if you have `TSA600` installed.
 - `nlmArray = Array("SMDR", "TSAFS /NoCluster")` if you have `TSAFS` installed.

Save the changes.

3. At the file server console, type `SMSSTOP`.
4. At the file server console, type `SMSSTART`.

Cluster shared volumes are now seen by the `TSA600.NLM` (`TSAFS.NLM`) module.

Installation

The installation procedure is the standard procedure for local installation of Data Protector on a Novell Netware client. Refer to "[Local installation of the Novell NetWare clients](#)" on page 128 for detailed instructions.

What's next?

When the installation has been completed:

- If you want to back up the physical nodes, you must also import them into the cell.
- If you want to back up the virtual server (shared cluster volumes), you must import it into the cell.

See "[Importing a cluster-aware client to a cell](#)" on page 210. Refer to the online Help index: "configuring" for more information on how to configure backup devices, media pools, or any additional Data Protector configuration tasks.

3 Maintaining the installation

In this chapter

This chapter describes the procedures most frequently performed to modify the configuration of your backup environment. The following sections provide information about:

- How to import clients to a cell using the graphical user interface. Refer to [“Importing clients to a cell”](#) on page 207.
- How to import an Installation Server to a cell using the graphical user interface. Refer to [“Importing an installation server to a cell”](#) on page 210.
- How to import clusters/virtual servers using the graphical user interface. Refer to [“Importing a cluster-aware client to a cell”](#) on page 210.
- How to export clients using the graphical user interface. Refer to [“Uninstalling Data Protector software”](#) on page 231.
- How to ensure security using the graphical user interface. Refer to [“Security considerations”](#) on page 216.
- How to verify which Data Protector patches are installed. Refer to [“Verifying which Data Protector patches are installed”](#) on page 229.
- How to uninstall the Data Protector software. Refer to [“Uninstalling Data Protector software”](#) on page 231.
- How to add or remove Data Protector software components. Refer to [“Changing Data Protector software components”](#) on page 245.

Importing clients to a cell

When you distribute Data Protector software to clients using the Installation Server, the client systems are automatically added to the cell. As soon as the remote installation has finished, the client becomes a member of the cell.

When to import?

Some of the clients, such as Novell NetWare, OpenVMS, and Windows XP Home Edition, must be imported to the cell after the installation. **Importing** means manually adding a computer to a cell after the Data Protector software has been installed. When added to a Data Protector cell, the system becomes a Data Protector client. Once the system is a member of the cell, information about the new client is written to the IDB, which is located on the Cell Manager.

A client can only be a member of one cell. If you wish to move a client to a different cell, you first *export* it from its current cell and then *import* it to the new cell. For the procedure on how to export clients, refer to “[Exporting clients from a cell](#)” on page 213.

NOTE:

Before importing an IAP Server, make sure you have added a certificate file for accessing the IAP appliance to the Cell Manager. For a detailed procedure, see the online Help index: “adding, IAP certificates”.

IMPORTANT:

After you have installed Data Protector clients and imported them to a cell, it is highly recommended to protect the clients from access by unwanted cell authorities. Refer to “[Securing clients](#)” on page 219.

How to import?

You import a client system using the graphical user interface by performing the following steps:

1. In the Context List, click **Clients**.
2. In the Scoping Pane, right-click **Clients** and click **Import Client**.

3. Type the name of the client or browse the network to select the client (on Windows GUI only) you want to import. See [Figure 33](#) on page 209.

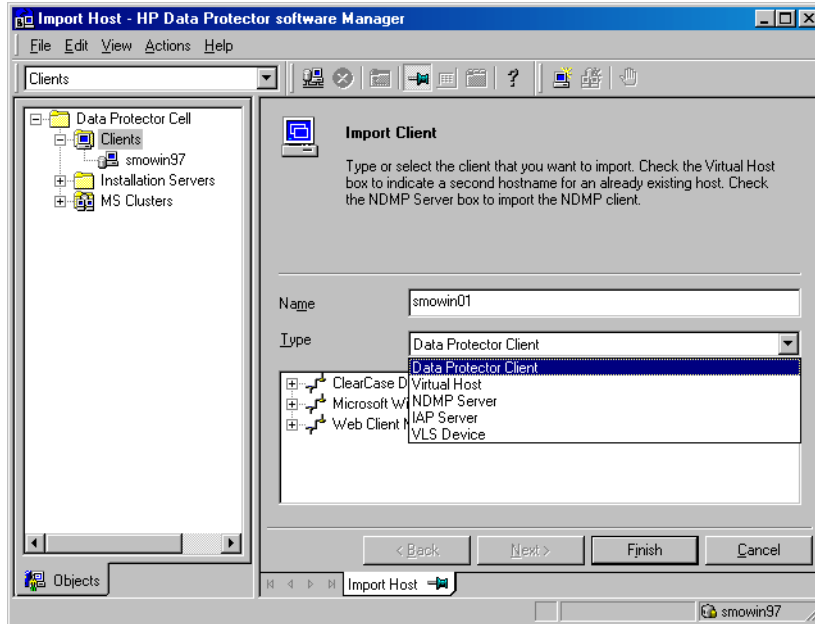

Figure 33 Importing a client to the cell TBD

If you are importing a client configured with multiple LAN cards, select the **Virtual Host** option. With this option you must import all names of the same system.

If you are importing an NDMP client, select the **NDMP Server** option and click **Next**. Specify the information about the NDMP Server.

If you are importing an OpenVMS client

If you are importing an IAP Server, select the **IAP Server** option and click **Next**. Specify the information about the IAP Server.

If you are importing a VLS device, select the **VLS Device** option and click **Next**. Specify the information about the VLS device.

Click **Finish** to import the client.

The name of the imported client is displayed in the Results Area.

Importing an installation server to a cell

When to add?

An Installation Server must be added to a cell in the following circumstances:

- If it is installed as an independent UNIX Installation Server, i.e., it is not installed on a Cell Manager.
In this case, it will not be possible to remotely (push) install any clients within a cell until the Installation Server has been added to that cell.
- If it is installed on a Cell Manager, but you also want to use it to perform remote installations in another cell. It must then be added to the other cell (using the GUI connected to the Cell Manager of the other cell).

Unlike a client, an Installation Server can be a member of more than one cell. Therefore it does not have to be deleted (exported) from one cell before it can be added (imported) to another cell.

How to add?

The process for importing an Installation Server is similar to that for importing a client. The task is performed using the Data Protector GUI (connected to the Cell Manager of the cell to which the Installation Server is to be added) by performing the following steps:

1. In the Context List, click **Clients**.
2. In the Scoping Pane, right-click **Installation Servers**, and then click **Import Installation Server** to start the wizard. See [Figure 33](#) on page 209.
3. Enter or select the name of the system that you want to import. Click **Finish** to import the Installation Server.

Importing a cluster-aware client to a cell

After you have locally installed the Data Protector software on a cluster-aware client, import the virtual server representing the cluster-aware client to the Data Protector cell.

Prerequisites

- Data Protector must be installed on all cluster nodes.

- All cluster packages must be running within the cluster.

Microsoft Cluster Server

To import a Microsoft Cluster Server client to the Data Protector cell, proceed as follows:

1. In the Data Protector , switch to the Clients context.
2. In the scoping pane, right-click **MS Clusters** and click **Import Cluster**.
3. Type the name of the virtual server representing the cluster client to be imported or browse the network to select the virtual server. See [Figure 34](#) on page 211 .

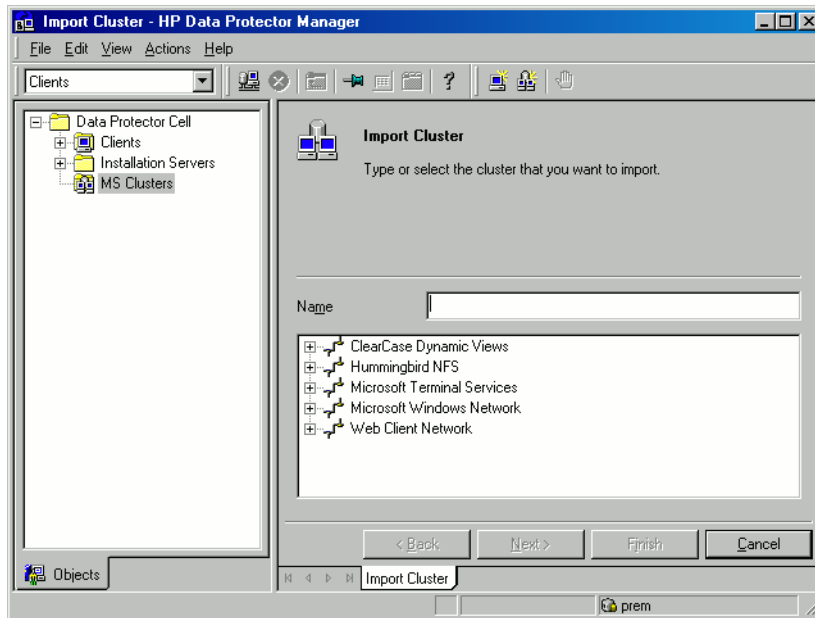

Figure 34 Importing a Microsoft Cluster Server client to a cell

4. Click **Finish** to import the cluster client.

 **TIP:**

To import a specific cluster node or a virtual server, right click its cluster in the Scoping Pane and click **Import Cluster Node** or **Import Cluster Virtual Server**.

Other clusters

Tru64 Cluster prerequisites

Before importing cluster hostnames, make sure that:

- Data Protector is installed on the shared disk in the cluster
- All Tru64 Cluster nodes are running within the Tru64 Cluster
- Data Protector `inetd` process is running on each node

Procedure

To import a MC/ServiceGuard, Veritas, Tru64 Cluster, or Novell NetWare Cluster Services client to the Data Protector cell, proceed as follows:

1. In the Data Protector Manager, switch to the Clients context.
2. In the Scoping Pane, right-click **Clients** and click **Import Client**.
3. Type the hostname of the virtual server as specified in the application cluster package, or browse the network to select the virtual server (on Windows GUI only) you want to import.

Select the **Virtual Host** option to indicate that this is a cluster virtual server. See [Figure 35](#) on page 213.

4. Click **Finish** to import the virtual server.

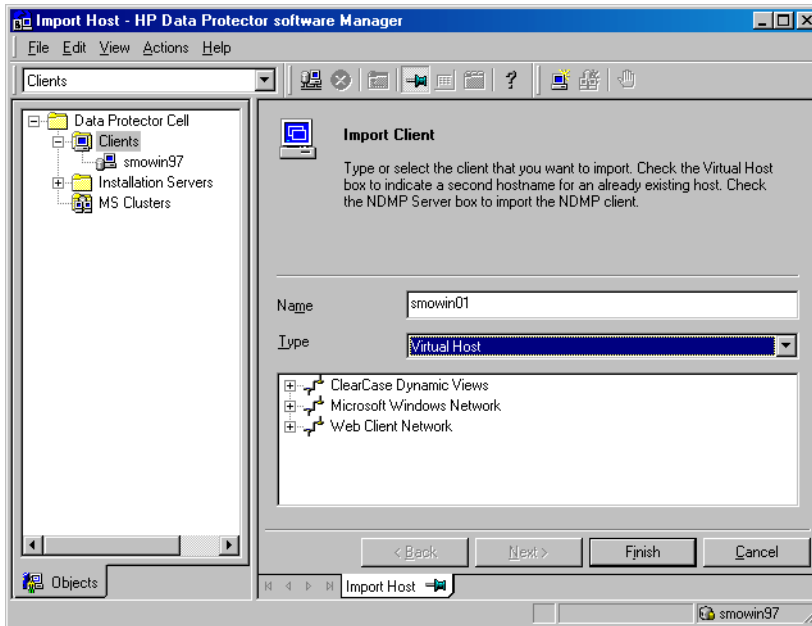

Figure 35 Importing a MC/ServiceGuard, Veritas, or Novell NetWare Cluster Services client to a cell TBD

TIP:

To configure backups of data on the local disks of the cluster nodes, you need to import the cluster nodes representing the Data Protector clients. For the procedure, see “Importing clients to a cell ” on page 207.

Exporting clients from a cell

Exporting a client from a Data Protector cell means removing its references from the IDB on the Cell Manager without uninstalling the software from the client. This can be done using the Data Protector GUI.

You may want to use the export functionality if you:

- Want to move a client to another cell
- Want to remove a client from the Data Protector cell configuration which is no longer part of the network
- Want to fix problems caused by insufficient licenses

By exporting a client from a cell, the license becomes available to some other system.

Prerequisites

Before you export a client, check the following:

- All the occurrences of the client have been removed from backup specifications. Otherwise, Data Protector will try to back up unknown clients and this part of the backup specification will fail. Refer to online Help index: “modifying, backup specification” for instructions on how to modify backup specifications.
- The client does not have any connected and configured backup devices. Once the system is exported, Data Protector can no longer use its backup devices in the original cell.

How to export?

You export a client using the Data Protector GUI by performing these steps:

1. In the Context List, click **Clients**.

2. In the Scoping Pane, click **Clients**, right-click the client system that you want to export, and then click **Delete**. See [Figure 36](#) on page 215.

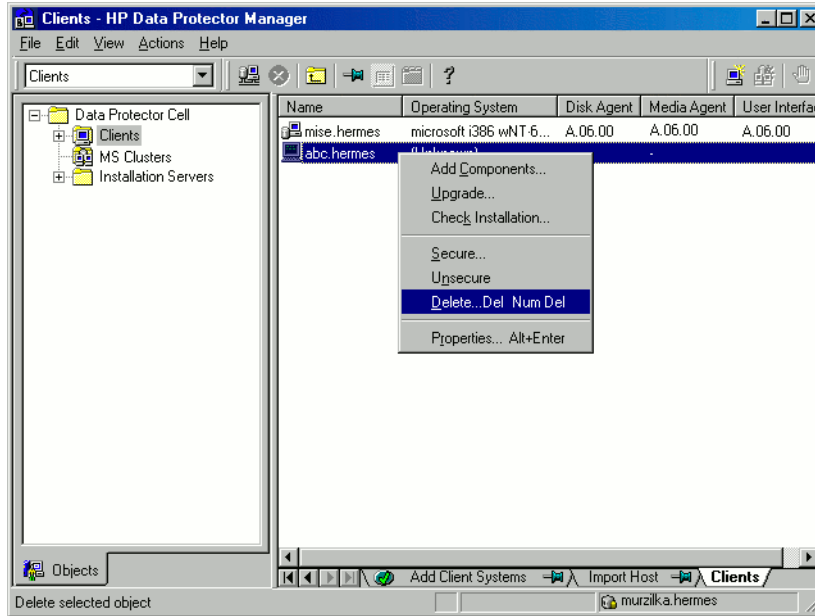

Figure 36 Exporting a client system

3. You will be asked if you want to uninstall Data Protector software as well. Click **No** to export the client, and then click **Finish**.

The client will be removed from the list in the Results Area.

 **NOTE:**

You cannot export or delete a Data Protector client if the Cell Manager is installed on the same system as the client you would like to export. However, you can export the clients from systems where only the client and Installation Server are installed. In this case, Installation Server is also removed from the cell.

Microsoft Cluster Server clients

To export a Microsoft Cluster Server client from the Data Protector cell, proceed as follows:

1. In the Context List, click **Clients**.

2. In the Scoping Pane, expand **MS Clusters**, right-click the cluster client that you want to export, and then click **Delete**.
3. You are asked if you also want to uninstall the Data Protector software. Click **No** to only export the cluster client.

The cluster client will be removed from the list in the Results Area.



To export a specific cluster node or a virtual server, right-click the cluster node or virtual server in the Scoping Pane and click **Delete**.

Security considerations

This section describes the security elements of Data Protector. It describes the advanced settings that can be used to enhance the security of Data Protector with prerequisites and considerations that have to be taken into account.

Since enhancing security in an entire environment requires additional effort, many security features cannot be enabled by default.

The considerations described in this chapter apply not only when the security settings are changed, but must also be followed when configuring new users, adding clients, configuring Application Agents, or making any other changes these considerations apply to. Any changes in the security settings can have cell-wide implications and should be carefully planned.

Security layers

Security has to be planned, tested and implemented on different security-critical layers to ensure the secure operation of Data Protector. Such layers are Data Protector clients, Cell Manager and users. This section explains how to configure security on each of these layers.

Client security

Data Protector agents installed on clients in the cell provide numerous powerful capabilities, like access to all the data on the system. It is important that these capabilities are available only to the processes running on **cell authorities** (Cell Manager and Installation Server), and that all other requests are rejected.

Before securing clients, it is important to determine a list of trusted hosts. This list must include:

- Cell Manager
- Relevant Installation Servers
- For some clients also a list of clients that will access the robotics remotely.

 **IMPORTANT:**

The list must contain all possible hostnames (or IP addresses) where connections can come from. Multiple hostnames may be needed if any of the above clients is multihomed (has multiple network adapters and/or multiple IP addresses) or is a cluster.

If the DNS configuration in the cell is not uniform, additional considerations may apply. For more information, refer to “[Securing clients](#)” on page 219.

While it may not always be necessary to secure each and every client in the cell, it is important that the computers that other clients will trust are secured themselves:

- Cell Manager / MoM
- Installation Servers
- Media Agent (MA) clients.

 **NOTE:**

User interface clients do not need to be added to the list of trusted clients. Depending on the user rights, you can either use the GUI to access the complete Data Protector functionality or to access only specific contexts.

Data Protector users

Consider the following important aspects when configuring Data Protector users:

- Some user rights are very powerful. For example, the `User configuration` and `Clients configuration` user rights enable the user to change the security settings. `Restore to other clients` user right is also very powerful, especially if (but not only if) combined with either the `Back up as root` or `Restore as root` user rights.
- Even less powerful user rights bear an inherent risk associated with them. Data Protector can be configured to restrict certain user rights to reduce these risks.

These settings are described later on in this chapter. See also “[Start backup specification user right](#)” on page 227.

- Data Protector comes with only a few predefined user groups. It is recommended to define specific groups for each type of user in the Data Protector environment to minimize the set of rights assigned to them.
- The configuration of users is connected with user validation (see “[Strict hostname checking](#)” on page 225). Enhanced validation can be worthless without careful user configuration and vice versa - even the most careful user configuration can be worked around without the enhanced validation.
- It is important that there are no “weak” user specifications in the Data Protector user list.



NOTE:

The *host* part of a user specification is the strong part (especially with the enhanced validation), while *user* and *group* parts cannot be verified reliably. Any user with powerful user rights should be configured for the specific client they will use for Data Protector administration. If multiple clients are used, an entry should be added for each client, rather than specifying such a user as *user, group, <Any>*. Non-trusted users should not be allowed to log on to any of those systems.

See also the online Help index: “configuring, users” for details on configuring users.

Cell Manager security

Cell Manager security is important because the Cell Manager has access to all clients and all data in the cell.

Security of the Cell Manager can be enhanced via the strict hostname checking functionality. However, it is important that the Cell Manager is also secured as a client and that Data Protector users are configured carefully. Refer to “[Strict hostname checking](#)” on page 225 and “[Securing clients](#)” on page 219.

Other security aspects

There are also some other security related aspects you should consider:

- Users should not have access to any of the trusted clients (Cell Manager, Installation Servers, MA, and robotics clients). Even granting `anonymous` log on or `ftp` access could introduce a serious risk to overall security.

- Media and tape libraries (and the clients they are connected to) must be physically protected from unauthorized or untrusted personnel.
- During backup, restore, object or media copying, or object consolidation, data is transferred via network. If sufficient separation from the untrusted network cannot be achieved with network segmentation, use locally attached devices or a custom encoding library. Note that after changing the encoding library, you should perform a full backup.

Refer also to the *HP Data Protector concepts guide* for other security related aspects.

Securing clients

After you have installed Data Protector clients and imported them to a cell, it is highly recommended to protect the clients from access by unwanted clients.

Data Protector allows you to specify from which cell authorities (Cell Manager, MoM, and Installation Servers) a client will accept requests on the Data Protector port 5555. Consequently, other computers will not be able to access such a client. See also “[Client security](#)” on page 216.



NOTE:

Clients that will access library robotics remotely should be added to the cell authorities list for the library robotics clients.

For tasks like backup and restore, starting pre- or post-execution scripts, or importing and exporting clients, the client checks whether the computer which triggers one of these tasks via the Data Protector port (default 5555) is allowed to do so. This security mechanism instructs the client to accept such actions only from the specified cell authorities.

Consider exceptional situations

Before limiting the access to clients, consider the following circumstances which may cause problems:

- A cell authority has several LAN cards and several IP addresses/client names.
- The Cell Manager is cluster-aware.
- A tape library has robotics configured on a separate (or dedicated) system.

Data Protector lets you specify not only one but a list of systems that are explicitly authorized to connect as a cell authority to the client. To avoid failure, prepare in advance such a list of all possible valid client names for alternate cell authorities.

The list should include:

- All additional client names (for all LAN cards) of the cell authority.
- Client names of all cluster nodes where the Cell Manager might failover, as well as a cluster virtual server hostname.
- The target system name to which a cell authority will be moved in case of a total hardware failure of the cell authority. This target system has to be defined in the disaster recovery strategy.
- For clients that are allowed to access a client that controls the robotics of a library, all clients that use the drives of that library.

The concept of allowing and denying access can be applied to all systems with Data Protector installed. For example, you can allow or deny access of Cell Managers to clients, Cell Managers to Cell Managers, Installation Servers to clients, or clients to clients.



NOTE:

If an Installation Server residing on a system other than the Cell Manager is not added to the list of allowed clients, it will not have access to a secured client. In this case, the operations dependent on the Installation Server (such as checking installation, adding components and removing clients) will fail. If you want these operations to be available on the secured client, add the Installation Server to the list of allowed clients.

How to secure a client

To enable verification of a cell authority on the client side (secure a client), perform the following steps in the Data Protector GUI:

1. In the Context List, click **Clients**.

2. In the Scoping Pane, expand Clients, right-click the client(s) you want to secure, and click **Secure**. See [Figure 37](#) on page 221.

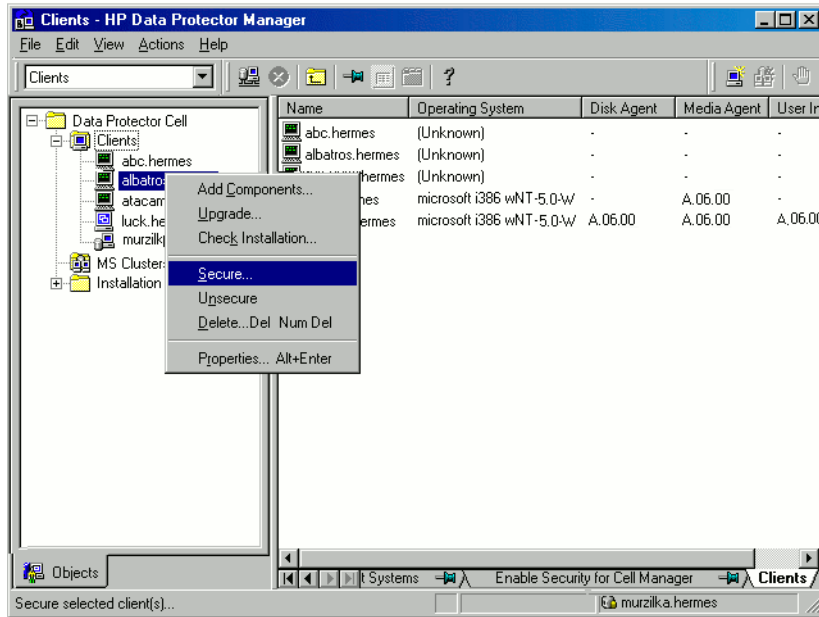

Figure 37 Securing a client

3. Type the names of the systems that will be allowed to access the selected client(s) or search for the systems using the Network or Search tabs. Click **Add** to add each system to the list. See [Figure 38](#) on page 222.

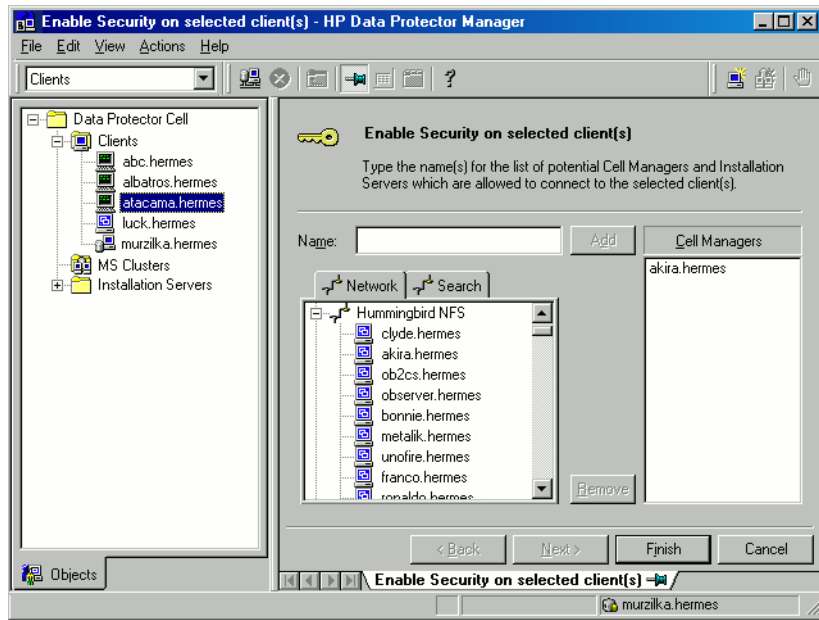

Figure 38 Enabling security on selected client(s)

The Cell Manager is automatically provided with access and added to the list of trusted clients. You cannot exclude the Cell Manager from the list.

4. Click **Finish** to add the selected systems to the `allow_hosts` file.

What happens?

Clients will verify the source for each request from other clients and allow only those requests received from clients selected in the Enable Security on selected client(s) window. These clients are listed in the `allow_hosts` file. If a request is denied, the event is logged to the `inet.log` file in the following directory:

- On Windows: `Data_Protector_home\log`
- On HP-UX, Solaris, and Linux: `/var/opt/omni/log`
- On other UNIX systems: `/usr/omni/log`

To secure all clients in the cell, perform the following steps in the Data Protector GUI:

1. In the Context List, click **Clients**.

2. Type the names of the systems that will be allowed to access all clients in the cell or search for the systems using the *Network* (on Windows GUI only) or *Search* tabs. Click **Add** to add each system to the list. See [Figure 39](#) on page 223.

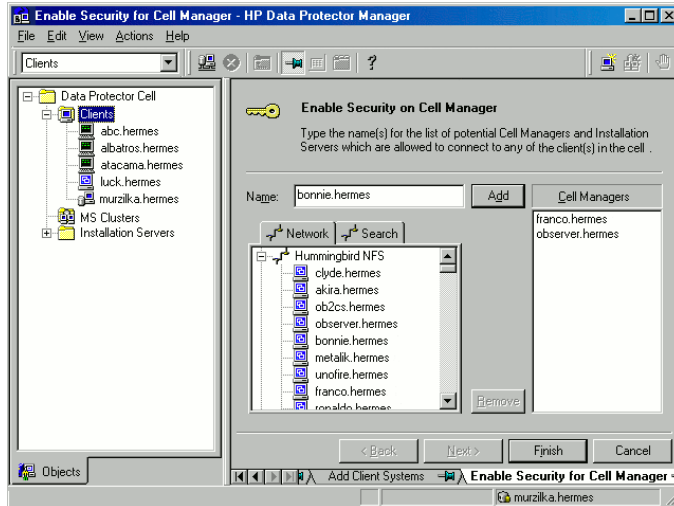

Figure 39 Enabling security for all clients in the cell

3. Click **Finish** to add the selected systems to the `allow_hosts` file.

What happens?

Clients will verify the source of each request and allow only those requests received from clients selected in the Enable Security on Cell Manager window. These clients are listed in the `allow_hosts` file. If a request is denied, the event is logged to the `inet.log` file in the following directory:

- On Windows: `Data_Protector_home\log`
- On HP-UX, Solaris, and Linux: `/var/opt/omni/log`
- On other UNIX systems: `/usr/omni/log`

When you secure an entire cell, all clients residing in this cell at the time are secured. When you add new clients to the cell, you should also secure them.

How to remove security

If you want to remove security from the selected system(s), perform the following steps in the Data Protector GUI:

1. In the Context List, click **Clients**.

2. In the Scoping Pane, right-click the client(s) from which you want to remove security and click **Unsecure**.
3. Click **Yes** to confirm that you allow access to the selected client(s).

If you want to remove security from all the clients in the cell, proceed as follows:

1. In the Context List, click **Clients**.
2. In the Scoping Pane, right-click **Clients** and click **Cell Unsecure**.
3. Click **Yes** to confirm that you allow access to all client(s) in your cell.

The `allow_hosts` and `deny_hosts` files

When you secure a client, the client names of the systems allowed to access a client are written to the `allow_hosts` file. You can also explicitly deny access to a client from certain computers by adding their names to the `deny_hosts` file. These files are located in the `\Config\client` following directory:

- On Windows: `Data_Protector_home\Config\client`
- On HP-UX, Solaris, and Linux: `/etc/opt/omni/client`
- On other UNIX systems: `/usr/omni/config/client`

Specify each client name in a separate line.



NOTE:

If you accidentally lock out a client, you can manually edit (or delete) the `allow_hosts` file on this client.

On Windows systems, the files are in double-byte format (Unicode), whereas on HP-UX, Solaris, and Linux systems the files are in single-byte format or multi-byte format (for example, Shift-JIS).

Excessive logging to the `inet.log` file

If the clients are not secured and the Cell Manager is configured in the MC/ServiceGuard environment or has multiple names or IP numbers, the `inet.log` file may contain many entries of the following type:

```
A request 0 came from host name.company.com which is not a  
Cell Manager of this client
```

This happens because the client, which is not secured, recognizes only the primary hostname of the Cell Manager. Requests from any other clients are allowed, but logged to the `inet.log` file.

When a client is secured, requests from the clients listed in the `allow_hosts` file are accepted, and are thus not logged. Requests from other clients are denied.

Securing clients can be used as a workaround to prevent unnecessary entries in `inet.log` files. However, all possible client names for the Cell Manager should be listed in the `allow_hosts` file on each client. This enables access to the client also in case of a failover.

If this workaround is for any reason not possible in your environment, you can secure the clients and specify `*` as an IP address range for the systems you want to allow access. This means that your clients will accept requests from all systems (any IP address) and will practically not be secured, but you will still resolve the excessive logging issue.

Strict hostname checking

By default, the Cell Manager uses a relatively simple method for validating users. It uses the hostname as known by the client where a user interface or an Application Agent is started. This method is easier to configure and it provides a reasonable level of security in environments where security is considered as “advisory” (i.e. malicious attacks are not expected).

The strict hostname checking setting on the other hand, provides enhanced validation of users. The validation uses the hostname as it is resolved by the Cell Manager using the reverse DNS lookup from the IP obtained from the connection. This imposes the following limitations and considerations:

Limitations

- IP based validation of users can only be as strong as the anti-spoof protection in the network. The security designer must determine whether the existing network provides a sufficient degree of anti-spoof safety for the particular security requirements. Anti-spoof protection can be added by segmenting the network with firewalls, routers, VPN, and such.
- The separation of users within a certain client is not as strong as the separation between clients. In a high security environment, one must not mix regular and powerful users within the same client.
- Hosts that are used in user specifications cannot be configured to use DHCP, unless they are bound to a fixed IP and configured in the DNS.

Be aware of the limitations in order to correctly assess the degree of safety that can be achieved with the strict hostname checking.

Hostname resolution

The hostname that Data Protector uses for validation may differ between the default user validation and strict hostname checking in the following situations:

- Reverse DNS lookup returns a different hostname. This can be either intentional or can indicate misconfiguration of either the client or the reverse DNS table.
- The client is multihomed (has multiple network adapters and/or multiple IP addresses). Whether this consideration applies to a specific multihomed client, depends on its role in the network and on the way it is configured in the DNS.
- The client is a cluster.

The nature of checks that are enabled with this setting may require reconfiguration of Data Protector users. Existing specifications of Data Protector users must be checked to see if they could be affected by any of the above reasons. Depending on the situation, existing specifications may need to be changed or new specifications added to account for all the possible IPs from which the connections can come.

Note that users have to be reconfigured also when reverting back to the default user validation, if you had to modify user specifications when you enabled the strict hostname checking. It is therefore recommended to decide which user validation you would like to use and keep using it.

A prerequisite for a reliable reverse DNS lookup is a secure DNS server. You must prevent physical access and log on to all unauthorized personnel.

By configuring users with IPs instead of hostnames, you can avoid some DNS related validation problems, but such configuration is more difficult to maintain.

Requirements

The enhanced validation does not automatically grant access for certain internal connections. Therefore, when this validation is used, a new user must be added for each of the following:

- Any Application Agent (OB2BAR) on Windows clients. For Windows clients, it is required to add the user `SYSTEM, NT AUTHORITY, client` for each client where an Application Agent is installed. Note that if `Inet` on a certain client is configured to use a specific account, this account must have already been configured. For more information, refer to the online Help index: "strict hostname checking".
- If you are using Web Reporting, user `java, applet, hostname` must be added for every hostname from where Web Reporting will be used. Note that for full

Web Reporting functionality the users must be in the `admin` group. Therefore, these clients must be trusted. Also, before making any data or functionality of Web Reporting available to other users (for example, via a web server), consider the security implications of making such data generally available.

For detailed information on user configuration, refer to the online Help index: “configuring, users”.

Enabling the feature

To enable the strict hostname checking, set the `StrictSecurityFlags` flag `0x0003` in the global options file.

For more information about the global options file, refer to the *HP Data Protector troubleshooting guide*.

Start backup specification user right

For general information about the Data Protector users and user rights, refer to the online Help index: “users”.

The `Start backup specification user right` alone does not enable a user to use the Backup context in the GUI. The user is allowed to start a backup specification from the command line by using the omnib with the `-datalist` option.

NOTE:

By combining the `Start Backup Specification` with the `Start Backup user rights`, a user is allowed to see the configured backup specifications in the GUI and is able to start a backup specification or an interactive backup.

Allowing users to perform interactive backups may not always be desired. To allow interactive backups only for users who also have the right to save a backup specification, set the `StrictSecurityFlags` flag `0x0200` in the global options file.

For more information on the global options file, refer to the *HP Data Protector troubleshooting guide*.

Hiding the contents of backup specifications

In a high security environment, the contents of saved backup specifications may be considered to be sensitive or even confidential information. Data Protector can be

configured to hide the contents of backup specifications for all users, except for those who have the *Save backup specification* user right. To do so, set the `StrictSecurityFlags` flag `0x0400` in the global options file.

For more information about the global options file, refer to the *HP Data Protector troubleshooting guide*.

Host trusts

The host trusts functionality reduces the need to grant the `Restore` to other clients user right to users when they only need to restore the data from one client to another within a limited number of clients. You can define groups of hosts that will trust each other with the data.

Host trusts are typically used in the following situations:

- For clients in a cluster (nodes and virtual server).
- If the hostname of a client is changed and the data from the old backup objects needs to be restored.
- If there is a mismatch between the client hostname and backup objects due to DNS issues.
- If a user owns several clients and needs to restore the data from one client to another.
- When migrating data from one host to another.

Configuration

To configure host trusts, create the `/etc/opt/omni/server/cell/host_trusts` file on a UNIX Cell Manager or `Data_Protector_home\Config\Server\cell\host_trusts` file on a Windows Cell Manager.

The groups of hosts that trust each other are defined as lists of hostnames enclosed in curly brackets. For example:

Example

```
GROUP="cluster.domain.com"
{
cluster.domain.com
node1.domain.com
node2.domain.com
}
GROUP="Bajo"
```

```
{
computer.domain.com
anothercomputer.domain.com
}
```

Monitoring security events

If you encounter problems using Data Protector, you can use the information in the log files to determine your problem. For example, logged events can help you to determine misconfigured users or clients.

Client security events

Client security events are logged in the `inet.log` file on every client in the cell directory.:

- On Windows: `Data_Protector_home\log`
- On HP-UX, Solaris, or Linux: `/var/opt/omni/log`
- On other UNIX systems: `/usr/omni/log`

Cell Manager security events

Cell Manager security events are logged in the `security.log` file `Data_Protector_home` directory on the Cell Manager.:

- On a Windows Cell Manager: `Data_Protector_home\log\server`
- On a UNIX Cell Manager: `/var/opt/omni/server/log`

Verifying which Data Protector patches are installed

You can verify which Data Protector patches are installed on each system in the cell.

Prerequisite

To use this functionality, you should have the User Interface or Java GUI Client component installed.

NOTE:

After you install a site-specific patch, it will always be listed in the patch report, even if it has been included into later patches.

To verify which Data Protector patches are installed on a particular system in a cell, use the Data Protector GUI or CLI.

Limitations

Below are the limitations for patch verification:

- Patch verification can check which patches are installed only on members that belong to the same cell.

Verifying Data Protector patches using the GUI

To verify which patches are installed on a particular client using the Data Protector GUI, follow the below procedure:

1. In the Context List, select **Clients**.
2. In the Scoping Pane, expand **Clients** and select a system in the cell for which you want to verify the patches installed.
3. In the Results Area, click **Patches** to open the **Patches on** window.

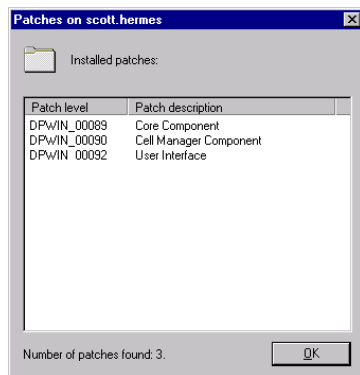

Figure 40 Verifying patches installed

If there are patches found on the system, the verification returns the level and the description of each patch and the number of the patches installed.

If there are no Data Protector patches on the system, the verification returns an empty list.

If the system verified is not a member of the cell, is unavailable, or an error occurs, the verification reports an error message.

4. Click **OK** to close the window.

Verifying Data Protector Patches Using the CLI

To verify which patches are installed on a particular client using the Data Protector CLI, run the `omnicheck -patches -host hostname` command from the following directory:

- On Windows: `Data_Protector_home\bin`
- On UNIX: `/opt/omni/bin`

where `hostname` is the name of the system to be verified.

Refer to the `omnicheck` man page for more information on the `omnicheck` command.

Uninstalling Data Protector software

If your system configuration changes, you may want to uninstall the Data Protector software from the system or remove some software components.

Uninstalling is removing all the Data Protector software components from the system, including *all* references to this system from the IDB on the Cell Manager computer. However, by default, the Data Protector configuration data remains on the system because you may need this data in the future upgrade of Data Protector. If you want to remove the configuration data after uninstalling the Data Protector software, delete the directories where Data Protector was installed.

If you have some other data in the directory where Data Protector is installed, make sure you copied this data to another location before uninstalling Data Protector. Otherwise, the data will be removed during the uninstallation process.

Uninstalling the Data Protector software from a cell consists of the following steps:

1. Uninstalling the Data Protector client software using the GUI. See [“Uninstalling a Data Protector client”](#) on page 232.
2. Uninstalling Data Protector Cell Manager and Installation Server. See [“Uninstalling the Cell Manager and Installation Server”](#) on page 233.

You can also uninstall Data Protector software components without uninstalling the Cell Manager or client. See [“Changing Data Protector software components”](#) on page 245

On UNIX, you can also manually remove the Data Protector software. See [“Manual removal of Data Protector software on UNIX”](#) on page 243.

Prerequisites

Before you uninstall the Data Protector software from a computer, check the following:

- Make sure that all references to the computer are removed from the backup specifications. Otherwise, Data Protector will try to back up unknown systems and this part of the backup specification will fail. Refer to online Help index: “modifying, backup specification” for instructions on how to modify backup specifications.
- Make sure that no backup devices are connected and configured on the system that you want to uninstall. Once the system is exported, Data Protector can no longer use its backup devices in the original cell.

Uninstalling a Data Protector client



NOTE:

The remote uninstallation procedure requires the Installation Server to be installed for the platforms from which you are uninstalling the Data Protector software.

You uninstall a client remotely by performing these steps in the Data Protector GUI:

- 1.** In the Context List, switch to the **Clients** context.
- 2.** In the Scoping Pane, expand **Clients**, right-click the client you want to uninstall, and then click **Delete**. You will be asked if you want to uninstall the Data Protector software as well.
- 3.** Click **Yes** to uninstall all the software components from the client, and then click **Finish**.

The client will be removed from the list in the Results Area and the Data Protector software will be deleted from its hard disk.

Note that the Data Protector configuration data remains on the client system. If you want to remove the configuration data, delete the directories where Data Protector was installed.

Uninstalling Data Protector also removes the Java GUI Client. Unless the **Permanently delete configuration data** checkbox is selected when uninstalling Data Protector, the Java GUI configuration data remains on the system.

Cluster clients

If you have cluster aware clients in your Data Protector environment and you want to uninstall them, you must do this locally. The procedure is the same as for uninstalling Cell Manager or Installation Server. Refer to “[Uninstalling the Cell Manager and Installation Server](#)” on page 233.

The cluster client will be removed from the list in the Results Area and the Data Protector software will be deleted from its hard disk.

TruCluster

To uninstall TruCluster clients, export the virtual node first. Then uninstall Data Protector clients from the node(s).

OpenVMS clients

A Data Protector OpenVMS client cannot be removed remotely using an Installation Server. It must be uninstalled locally.

To uninstall a Data Protector client from an OpenVMS system, follow these steps:

1. First export the client concerned from the Data Protector cell using the Data Protector GUI, as described in “[Exporting clients from a cell](#)” on page 213.

When asked whether you want to uninstall the Data Protector software as well, select **No**.

2. To delete the actual Data Protector client software, log in to the `SYSTEM` account on the OpenVMS client and execute the following command: `$ PRODUCT REMOVE DP`. Respond to the prompt with `YES`.



IMPORTANT:

This will shut down the Data Protector service and delete all the directories, files, and accounts associated with Data Protector on the OpenVMS system.

Uninstalling the Cell Manager and Installation Server

This section describes the procedure of uninstalling the Data Protector Cell Manager and Installation Server software from Windows, HP-UX, Solaris, and Linux systems.

Uninstalling from Windows system

Uninstalling on a Microsoft Cluster Server system

If you have installed HP AutoPass utility together with Data Protector on a Microsoft Cluster Server node, you must uninstall Data Protector from the same node, otherwise AutoPass will *not* be uninstalled.

To uninstall Data Protector software from a Windows system, follow these steps:

1. Make sure you have terminated all Data Protector sessions and exited the GUI.
2. In Windows Control Panel, click **Add/Remove Programs**.

3. Depending on whether you installed HP AutoPass or not, and if you want to remove the Data Protector configuration data or not, different actions apply.

 **IMPORTANT:**

If you leave the Data Protector configuration data on the system after the uninstallation, and you later install a lower version of the Data Protector Cell Manager than the uninstalled version was, note that the configuration data will be unusable.

To successfully install a lower version, during the installation choose the option that will remove the configuration data.

Proceed as follows:

- If AutoPass utility was installed together with Data Protector:
Select **HP Data Protector A.06.10** and click **Change** and then **Next**. In the Program Maintenance dialog box, select **Remove**. To permanently remove the Data Protector configuration data, select **Permanently remove the configuration data**. Otherwise, click **Next**.
If AutoPass was installed together with Data Protector and Data Protector is the only application using it, AutoPass is removed. Otherwise, AutoPass is only unregistered with Data Protector but remains installed. To manually remove AutoPass, run:

```
msiexec.exe /X Package_GUI_ID /qr INSTALLSTANDALONE=1
```

You can obtain the GUI ID by reading the registry entry
`HKEY_LOCAL_MACHINE\Software\Hewlett-Packard\HpOvLic`.
 - If AutoPass has not been installed:
 - To uninstall Data Protector and leave the Data Protector configuration data on the system, select **HP Data Protector A.06.10** and click **Remove**.
 - To uninstall Data Protector and remove the Data Protector configuration data, select **HP Data Protector A.06.10**, click **Change** and then **Next**. In the Program Maintenance dialog box, select **Remove**. Select **Permanently remove the configuration data** and click **Next**.
4. When uninstalling is completed, click **Finish** to exit the wizard.

If AutoPass was removed during the uninstallation of the Cell Manager, press **F5** in the Add/Remove Program window to refresh the list of installed programs and components.

Uninstalling from HP-UX system

IMPORTANT:

If you leave the Data Protector configuration data on the system after the uninstallation, and you later install a lower version of the Data Protector Cell Manager than the uninstalled version was, note that the configuration data will be unusable.

To successfully install a lower version, after the uninstallation remove the remaining Data Protector directories from your system.

Before you start uninstalling Data Protector software, shut down Data Protector processes running on the Cell Manager and/or Installation Server system:

1. Log in as root and execute the `omnisv -stop` command from the `/opt/omni/sbin` directory.
2. Enter the `ps -ef | grep omni` command to verify whether or not all the processes have been shut down. There should be no Data Protector processes listed after executing `ps -ef | grep omni`.

If you have any Data Protector processes running, stop them using the `kill -9 process_ID` command before you proceed with uninstalling.

3. Run `/usr/sbin/swremove DATA-PROTECTOR` to uninstall Data Protector software.
4. The HP AutoPass utility is not removed during the Data Protector uninstallation. You can manually remove it by running the `/usr/sbin/swremove HPOVLIC` command as the user root.

To remove the remaining Data Protector directories from your system refer to “[Manual removal of Data Protector software on UNIX](#)” on page 243.

Uninstalling the Cell Manager and/or Installation Server configured on MC/ServiceGuard

If your Cell Manager and/or Installation Server is configured on an MC/ServiceGuard cluster, perform the following steps to uninstall the software.

Primary node

Log on to the primary node and perform the following steps:

1. Stop the Data Protector package:

```
cmhaltpkg pkg_name
```

where *pkg_name* stands for the name of the cluster package.

For example:

```
cmhaltpkg ob2cl
```

2. Deactivate the cluster mode for the volume group:

```
vgchange -c n vg_name
```

(where *vg_name* stands for the path name of the volume group located in the subdirectory of the `/dev` directory).

For example:

```
vgchange -c n /dev/vg_ob2cm
```

3. Activate the volume group:

```
vgchange -a y -q y vg_name
```

For example:

```
vgchange -a y -q y /dev/vg_ob2cm
```

4. Mount the logical volume to the shared disk:

```
mount lv_path shared_disk
```

(where *lv_path* stands for the path name of the logical volume and *shared_disk* stands for the mount point or shared directory).

For example:

```
mount /dev/vg_ob2cm/lv_ob2cm /omni_shared
```

5. Remove Data Protector by using the swremove utility.

6. Remove the soft links:

```
rm /etc/opt/omni
```

```
rm /var/opt/omni
```

7. Remove the backup directories:

```
rm -rf /etc/opt/omni.save
```

```
rm -rf /var/opt/omni.save
```

- 8.** Remove the Data Protector directory with its contents:

```
rm -rf /opt/omni
```
- 9.** You can remove the HP AutoPass utility by running the `/usr/sbin/swremove HPOVLIC` command as the user root.
- 10.** Unmount the shared disk:

```
umount shared_disk
```

For example:

```
umount /omni_shared
```
- 11.** Deactivate the volume group:

```
vgchange -a n vg_name
```

For example:

```
vgchange -a n /dev/vg_ob2cm
```

Secondary node

Log on to the secondary node and perform the following steps:

- 1.** Activate the volume group:

```
vgchange -a y vg_name
```
- 2.** Mount the shared disk:

```
mount lv_path shared_disk
```
- 3.** Remove Data Protector by using the `swremove` utility.
- 4.** Remove the soft links:

```
rm /etc/opt/omni
```

```
rm /var/opt/omni
```
- 5.** Remove the backup directories:

```
rm -rf /etc/opt/omni.save
```

```
rm -rf /var/opt/omni.save
```
- 6.** Remove the Data Protector directory with its contents:

```
rm -rf /opt/omni
```

7. Remove the directories in the shared filesystem:

```
rm -rf shared_disk/etc_opt_omni
```

```
rm -rf shared_disk/var_opt_omni
```

For example:

```
rm -rf /omni_shared/etc_opt_omni
```

```
rm -rf /omni_shared/var_opt_omni
```

8. You can remove the HP AutoPass utility by running the `/usr/sbin/swremove HPOVLIC` command as the user root.

9. Unmount the shared disk:

```
umount shared_disk
```

10. Deactivate the volume group:

```
vgchange -a n vg_name
```

Data Protector is completely removed from the system.

Uninstalling from Solaris systems

Cell Manager

The Cell Manager for Solaris is always installed locally, using the `omnisetup.sh` command. Therefore, it must be uninstalled locally, using the `pkgrm` utility.

IMPORTANT:

If you leave the Data Protector configuration data on the system after the uninstallation, and you later install a lower version of the Data Protector Cell Manager than the uninstalled version was, note that the configuration data will be unusable.

To successfully install a lower version, after the uninstallation remove the remaining Data Protector directories from your system.

To uninstall the Data Protector Cell Manager, proceed as follows:

1. Make sure you have terminated all Data Protector sessions and exited the graphical user interface.

2. Enter the `pkginfo | grep OB2` command to list all the Data Protector packages installed on the Cell Manager.

The packages associated with the Cell Manager are as follows:

OB2-CORE	Data Protector Core software
OB2-C-IS	Installation Server software
OB2-CS	Cell Manager software
OB2-CC	Cell Console software, containing the graphical user interface and the command-line interface

If Data Protector clients or an Installation Server are also installed on the system, other packages will also be listed.



NOTE:

If you wish to leave any other Data Protector components installed, you must leave the OB2-CORE package installed, since it is a dependency for other packages.

3. In reverse order to the sequence in which they were installed, remove the packages mentioned in the previous step using the `pkgrm package name` command and follow the prompts.
4. The HP AutoPass utility is not removed during a Data Protector uninstallation. You can manually remove it by running the following commands as the user root:

```
swremove HPOvLic
```

Installation Server

The Installation Server for UNIX on Solaris is always installed locally, using the `omnisetup.sh` command. Therefore, it must be uninstalled locally, using the `pkgrm` utility.

To uninstall the Data Protector Installation Server, proceed as follows:

1. Make sure you have terminated all Data Protector sessions and exited the GUI.

2. Enter the `pkginfo | grep OB2` command to list all the Data Protector packages installed on the Installation Server system.

The packages associated with the Installation Server are as follows:

OB2-CORE	Data Protector Core software
OB2-C-IS	Installation Server Core software
OB2-SOLUX	Disk Agent, Media Agent and GUI packets for remote Solaris systems
OB2-OTHUX	Disk Agent and Media Agent packets for remote non-Solaris UNIX systems

If other Data Protector components are installed on the system, other packages will also be listed.



NOTE:

If you wish to leave any other Data Protector components installed, you must leave the OB2-CORE package installed, since it is a dependency for other packages.

3. In reverse order to the sequence in which they were installed, remove the packages mentioned in the previous step using the `pkgrm package name` command and follow the prompts.

Uninstalling from Linux systems

Cell Manager

The Cell Manager for Linux is always installed locally, using the `omnisetup.sh` command. Therefore, it must be uninstalled locally, using the `rpm` utility.

 **IMPORTANT:**

If you leave the Data Protector configuration data on the system after the uninstallation, and you later install a lower version of the Data Protector Cell Manager than the uninstalled version was, note that the configuration data will be unusable.

To successfully install a lower version, after the uninstallation remove the remaining Data Protector directories from your system.

To uninstall the Data Protector Cell Manager, proceed as follows:

1. Make sure you have terminated all Data Protector sessions and exited the graphical user interface.
2. Enter the **rpm -qa | grep OB2** command to list all the Data Protector packages installed on the Cell Manager.

The packages associated with the Cell Manager are as follows:

OB2-CORE	Data Protector Core software
OB2-CORE-IS	Installation Server software
OB2-CS	Cell Manager software
OB2-CC	Cell Console software, containing the command-line interface

If Data Protector clients or an Installation Server are also installed on the system, other packages will also be listed.

 **NOTE:**

If you wish to leave any other Data Protector components installed, you must leave the OB2-CORE package installed, since it is a dependency for other packages.

3. In reverse order to the sequence in which they were installed, remove the packages mentioned in the previous step using the `rpm -e package name` command and follow the prompts.

Installation Server

The Installation Server for UNIX on Linux is always installed locally, using the `omnisetup.sh` command. Therefore, it must be uninstalled locally, using the `rpm` utility.

To uninstall the Data Protector Installation Server, proceed as follows:

1. Make sure you have terminated all Data Protector sessions and exited the GUI.
2. Enter the `rpm -qa | grep OB2` command to list all the Data Protector packages installed on the Installation Server system.

The packages associated with the Installation Server are as follows:

OB2-CORE	Data Protector Core software
OB2-CORE-IS	Installation Server Core software
OB2-LINUXP	Disk Agent, Media Agent and GUI packets for remote Linux systems
OB2-OTHUXP	Disk Agent and Media Agent packets for remote non-Linux UNIX systems

If other Data Protector components are installed on the system, other packages will also be listed.



NOTE:

If you wish to leave any other Data Protector components installed, you must leave the OB2-CORE package installed, since it is a dependency for other packages.

3. In reverse order to the sequence in which they were installed, remove the packages mentioned in the previous step using the `rpm -e package name` command and follow the prompts.

Manual removal of Data Protector software on UNIX

Before uninstalling a UNIX client, you should export it from the cell. For procedure, refer to “[Exporting clients from a cell](#)” on page 213.

HP-UX systems

To manually remove the files from an HP-UX system, do the following:

1. Run `/usr/sbin/swremove DATA-PROTECTOR` to remove the Data Protector software.
2. Remove the following directories using the `rm` command:

```
rm -fr /var/opt/omni
```

```
rm -fr /etc/opt/omni
```

```
rm -fr /opt/omni
```

At this stage, Data Protector references no longer reside on your system.

Solaris systems

To manually remove files from a Solaris system, delete them from the following directories and then delete the directories using the `rm` command:

```
rm -fr /var/opt/omni
```

```
rm -fr /etc/opt/omni
```

```
rm -fr /opt/omni
```

Linux systems

To manually remove files from a Linux system, delete them from the following directories and then delete the directories using the `rm` command:

```
rm -fr /var/opt/omni
```

```
rm -fr /etc/opt/omni
```

```
rm -fr /opt/omni
```

Other UNIX systems

Delete the files from the following directory and then delete the directories using the `rm` command:

```
rm -fr /usr/omni
```

Changing Data Protector software components

This section describes the procedure for removing and adding Data Protector software components from or to Windows HP-UX, Solaris, and Linux systems. For the list of supported Data Protector components for a particular operating system, refer to the *HP Data Protector product announcements, software notes, and references*.

Data Protector software components can be added on the Cell Manager or on a client using the Data Protector GUI. You perform the remote installation of selected components using the Installation Server functionality. For the detailed procedure refer to “[Remote installation of Data Protector clients](#)” on page 77.

The Data Protector components can be removed locally on the Cell Manager or on a client.

On Windows systems

To add or remove the Data Protector software components on a Windows system, follow the steps below:

1. In the Windows Control Panel, click **Add or Remove Programs**.
2. Select **HP Data Protector A.06.10** and click **Change**.
3. Click **Next**.
4. In the Program Maintenance window, click **Modify** and then **Next**.
5. In the Custom Setup window, select the components you want to add and/or unselect the software components you want to remove. Click **Next**.
6. Click **Install** to start the installing or removing the software components.
7. When the installation is completed, click **Finish**.

Cluster-Aware clients

If you are changing the Data Protector software components on the cluster-aware clients, it must be done locally, from the DVD-ROM, on each cluster node. After that, the virtual server hostname has to be manually imported to the Data Protector cell using the GUI.

On HP-UX systems

You can add new components using the Installation Server functionality. On an HP-UX system, some Data Protector software components depend on each other and cannot

operate properly, if you remove one of them. The table below presents the components and their dependencies on each other:

Table 8 Data Protector software component dependencies on HP-UX

Components	Depend on
OMNI-CC, OMNI-CORE-IS	OMNI-CORE
OMNI-CS	OMNI-CORE, OMNI-CC
OMNI-INTEG , OMNI-DA, OMNI-MA or OMNI-NDMP	OMNI-CORE
OMNI-NDMP-P	OMNI-CORE-IS
OMNI-INF-P, OMNI-SYB-P, OMNI-ORA-P, OMNI-OR8-P, OMNI-SAP-P, OMNI-SAPDB-P, OMNI-DB2-P, OMNI-EMC-P, OMNI-SSEA-P, OMNI-SNAPA-P, OMNI-SMISA-P	OMNI-INTEG OMNI-CORE-IS
OMNI-HPUX-P, OMNI-OTHUX-P, OMNI-OMNIST	OMNI- CORE-IS
OMNI-LOTUS-P, OMNI-OV-P	OMNI-CORE-IS

Procedure

Perform the following procedure to remove Data Protector software components:

1. Log in as `root` and run the `swremove` command.
2. Double-click **B6960MA**, **DATA-PROTECTOR**, and then **OB2-CM** to display a list of the Data Protector components.
3. Select the components you want to remove.
4. In the **Actions** menu, click **Mark for Remove** to mark the components you want to remove.
5. When the components you want to remove are marked, click **Remove** in the **Actions** menu, and then click **OK**.

 **NOTE:**

When you mark the Data Protector components you want to remove, and if the remaining components cannot operate properly, the **Dependency Message Dialog** box appears with a list of dependent components.

Oracle specifics

After uninstalling the Data Protector Oracle integration on an Oracle server system, the Oracle server software is still linked to the Data Protector Database Library. You have to remove this link, otherwise the Oracle server cannot be started after removing the integration. Refer to the *HP Data Protector integration guide*, "Using Oracle after removing the Data Protector Oracle integration".

On Solaris systems

You can add new components using the Installation Server functionality. On Solaris systems, some Data Protector software components depend on each other and cannot operate properly, if you remove one of them. The table below presents the components and their dependencies on each other:

Table 9 Data Protector software component dependencies on Solaris

Components	Depend on
OB2-CC, OB2-C-IS	OB2-CORE
OB2-CS	OB2-CORE, OB2-CC
OB2-INTGP, OB2-DA, OB2-MA or OB2-NDMPP	OB2-CORE
OB2-SOLUX	OB2-C-IS
OB2-INFP, OB2-SYBP, OB2-OR8P, OB2-SAPP, OB2-SAPDP, OB2-DB2P, OB2-SSEAP, OB2-SMISP	OB2-INTGP OB2-C-IS
OB2-OTHUX, OB2-OSTP, OB2-LOTP, OB2-OVP	OB2-C-IS

Procedure

Perform the following procedure to remove Data Protector software components from the Solaris systems:

1. Make sure you have terminated all Data Protector sessions and exited the GUI.
2. Enter the command `pkginfo | grep OB2` to list all the Data Protector packages installed.
3. In reverse order to the sequence in which they were installed, remove the packages mentioned in the previous step using the `pkgrm package name` command and follow the prompts.

Other UNIX systems

When manually removing components from a Data Protector client on a UNIX system other than Solaris or HP-UX, update the `omni_info` file in `/usr/omni/bin/install/omni_info`.

For each of the uninstalled components, remove the associated component version string from the `omni_info` file.

If you are only removing components from a Data Protector client and have not exported the client from the cell, you will need to update the cell configuration in the `cell_info` file (on the Cell Manager). This can be done by running the following command on a system in the cell with the Cell Console installed:

```
/opt/omni/bin/omnicc -update_host HostName
```

4 Upgrading to Data Protector

A.06.10

In this chapter

This chapter provides instructions for performing Data Protector upgrade and migration tasks.

Upgrade overview

Before you begin

Before upgrading an existing product version to Data Protector A.06.10, consider the following:

- Refer to the *HP Data Protector product announcements, software notes, and references* for information about supported and discontinued platforms and versions.
- After the upgrade, the Cell Manager, Installation Server, and all clients must have the same Data Protector version installed.
- After the upgrade of a multiple-cell (MoM) environment, all Cell Managers must have the same Data Protector version installed.
- If you have a permanent license for Data Protector A.05.10, Data Protector A.05.50, or Data Protector A.06.00, it can be used with Data Protector A.06.10. Otherwise, be aware that you work with an Instant-On license, which will be valid for 60 days from the date of original installation.

For details about licensing, refer to [Chapter 5](#) on page 309.

Prerequisite

- Perform a backup of the existing Cell Manager system and the internal database (IDB).

- When migrating the Cell Manager from a system with Data Protector A.05.10, A.05.50, or A.06.00 to a system with Data Protector A.06.10, you must first upgrade the existing Cell Manager to Data Protector A.06.10.

Limitations

- The upgrade to Data Protector A.06.10 is only supported for Data Protector A.05.10, Data Protector A.05.50, and Data Protector A.06.00.
- A backup of the Internal Database, created with previous versions of Data Protector, cannot be restored with Data Protector A.06.10. After upgrading the Cell Manager, backup the Internal Database before you continue using Data Protector.
- Changing the Cell Manager platform is not supported in the A.06.10 release of Data Protector. Upgrades are only supported on the same Cell Manager platform (HP-UX to HP-UX, Solaris to Solaris, Linux to Linux, and Windows to Windows).
- If you are upgrading to Data Protector A.06.10 on Windows and you have the version of Microsoft Installer (MSI) older than 2.0, the Data Protector setup will automatically upgrade it to version 2.0. In this case, Data Protector will display a note at the end of the upgrade, stating that MSI was upgraded. It is highly recommended to restart the system, if MSI was upgraded. Consult Microsoft Support about the MSI 2.0 prerequisites for various Windows operating systems. To find out the version of MSI on your system, right-click the file `c:\winnt\system32\msi.dll` in Explorer and select **Properties**. In the Properties dialog box, select **Version**.

Upgrade sequence

To upgrade your cell from the earlier versions of the product to Data Protector A.06.10, proceed as follows:

1. Upgrade the Cell Manager and Installation Server to Data Protector A.06.10. The steps are different for UNIX and Windows platforms.

Note that you must first upgrade the Cell Manager in the current cell before you can upgrade the Installation Server.

For some specific cell configurations, the file names in the IDB need to be converted after the upgrade of the Cell Manager has been performed. You will be prompted in such case. Refer to [Table 10](#) on page 280 and [Table 11](#) on page 281.

2. Upgrade the GUI clients.

3. Upgrade the clients that have an online application integration installed, such as Oracle, SAP R/3, Informix Server, Microsoft SQL Server, Microsoft Exchange Server, and other.
4. Upgrade the clients that have a Media Agent (MA) installed. You can perform backups as soon as MA is upgraded on all MA clients of the same platform as the Cell Manager. For the Data Protector A.05.10 MA client, certain limitations apply. Refer to [Table 10](#) on page 280 and [Table 11](#) on page 281.
5. Upgrade the clients that have the filesystem Disk Agent (DA) installed within the next two weeks.

For information on impact of DA version on backup and restore before and after the IDB file name conversion, refer to [“Conversion of file names in the IDB”](#) on page 279.

Upgrading in a MoM environment

To upgrade your MoM environment to Data Protector A.06.10, you need to upgrade the MoM Manager system first. After this is done, all Cell Managers of the previous versions, which have not been upgraded yet, are able to access the Central MMDB and central licensing, perform backups, but other MoM functionality is not available. Note that device sharing between the Data Protector A.06.10 MoM cell and the cells with earlier versions of the product installed is not supported. During the upgrade in a MoM environment, none of the Cell Managers in the MoM environment should be operational.

The need to convert file names in the IDB

Data Protector versions A.05.50, A.06.00 and A.06.10 have improved handling and display of file names created with different locales on different platforms. This requires a conversion of the existing file names in the IDB for some specific cell configurations in case you are upgrading from Data Protector A.05.10.

The conversion is performed on the:

- UNIX Cell Manager as a part of post-upgrade backups of Windows clients.
- Windows Cell Manager as a background process after the upgrade of the Cell Manager.

You will be prompted, if it is needed to perform the IDB conversion.

UNIX

On a UNIX Cell Manager, the IDB conversion is performed as a part of the post-upgrade backups of Windows clients until

- the period for conversion expires, or
- a full backup of all Windows clients in the cell has been performed. This step is very important and must be done.

For file name conversion performance related figures refer to the *HP Data Protector product announcements, software notes, and references*.

Windows

On a Windows Cell Manager, the IDB conversion can be postponed, however, certain limitations apply until it is performed.

More detailed information regarding the file name conversion in the IDB on Windows and UNIX Cell Managers can be found in [“Conversion of file names in the IDB”](#) on page 279.

Automigration of encryption keys

After the upgrade of the Cell Manager, Installation Server, and all clients to the Data Protector A.06.10, the `omnikeymigrate` command automatically migrates all existing `key store` files from all client systems in the cell and imports them into the central `key store` file on the Data Protector A.06.10 Cell Manager. If automigration, for any reason, is not functioning, you can manually migrate the encryption keys. For details, refer to the `omnikeymigrate` man page or the *HP Data Protector command line interface reference*.

Upgrading from Data Protector A.05.10, A.05.50, and A.06.00

The Data Protector A.05.10, A.05.50 and A.06.00 release versions can be directly upgraded to Data Protector A.06.10 for UNIX and Windows platforms.

Licenses

The existing Data Protector A.05.10, A.05.50 and A.06.00 licenses are fully compatible and valid for use with Data Protector A.06.10. For details about licensing, refer to [Chapter 5](#) on page 309.

Before you begin

Before you begin with the upgrade, refer to “[Upgrade overview](#)” on page 249 for information on limitations and the upgrade sequence.

NOTE:

The procedures in this chapter for installing the Cell Manager, Installation Server, and for local installation of clients are written for DVD-ROM installation media. If you are using CD-ROM media, see also the [Appendix C](#), where a list of CD-ROMs is provided together with the differences in the upgrade procedure.

Upgrading the UNIX Cell Manager and Installation Server

Prerequisites

- Stop all Data Protector services using the `/opt/omni/sbin/omnisv -stop` command.
- On Solaris, if you have any old patches installed, uninstall them before the upgrade.
- A POSIX shell (`sh`) is required for the installation.
- You must have `root` permissions to perform the upgrade.

If the HP-UX, Solaris, or Linux Installation Server is installed together with the Cell Manager, it is upgraded automatically when the `omnisetup.sh` command is run.

If the HP-UX, Solaris, or Linux Installation Server is installed on a separate system, refer to “[Upgrading an Installation Server](#)” on page 256.

Upgrading a Cell Manager

The HP-UX, Solaris, or Linux Cell Manager is upgraded automatically when the `omnisetup.sh` command is run.

On HP-UX, this command directly upgrades the existing package set using the `swinstall` utility. On Solaris, this command removes the existing package set using the `pkgrm` utility and installs new packages using the `pkgadd` utility. On Linux, this command directly upgrades the existing package set using `rpm`.

If the Installation Server is installed with client components, it will be removed by the `omnisetup.sh` command. In this case, install a new Installation Server depot using

the `omnisetup.sh -IS` command, and then re-import the upgraded Installation Server. For details, refer to [Importing an installation server to a cell](#) .

MC/ServiceGuard

The upgrade procedure for the Cell Manager, configured on MC/SG differs from the upgrade procedure for the Cell Manager not running in the MC/SG environment. The detailed steps you need to follow are described in [“Upgrading the Cell Manager configured on MC/ServiceGuard”](#) on page 300.

Setting kernel parameters

On HP-UX systems, it is recommended that you set the kernel parameter `maxdsiz` (Max Data Segment Size) or `maxdsiz_64` (for 64bit systems) to at least 134217728 bytes (128 MB), and the kernel parameter `semnu` (Number of Semaphore Undo Structures) to at least 256. After you commit these changes, recompile the kernel and reboot the machine.

On Solaris systems, it is recommended that you set the kernel parameter `shmsys:shminfo_shmmax` (maximum shared memory segment size (SHMMAX)) in `/etc/system` to at least 67108864 bytes (64 MB). After you commit this change, reboot the machine.

Upgrade procedure

To upgrade the HP-UX, Solaris, or Linux Cell Manager to Data Protector A.06.10, follow the procedure described below:

1. Insert and mount the UNIX installation DVD-ROM to a mount point.

For example:

```
mkdir /dvdrom mount /dev/c0d0t0 /dvdrom
```

Optionally, you can install Data Protector from a depot on the disk, perform the following:

- Copy the `DP_DEPOT`, `AUTOPASS`, and `LOCAL_INSTALL` directories, where the installation files are stored:

```
mkdir directory cp -r /dvdrom/platform_dir/DP_DEPOT
directory cp -r /dvdrom/platform_dir/AUTOPASS directory
cp -r /dvdrom/LOCAL_INSTALL directory
```

Where *platform_dir* is:

<code>hpux_ia</code>	HP-UX on IA-64 systems
<code>hpux_pa</code>	HP-UX on PA-RISC systems
<code>solaris</code>	Solaris systems
<code>linux</code>	Linux systems

- Copy the whole DVD-ROM to your local disk:

```
cp -r /dvdrom dvd_image_dir
```

2. Run the `omnisetup.sh` command.

To run this command from the DVD-ROM, execute:

```
cd /dvdrom/LOCAL_INSTALL ./omnisetup.sh
```

To start the installation from disk, run:

- If you have copied the `DP_DEPOT`, `AUTOPASS`, and `LOCAL_INSTALL` directories to your local disk under *directory*, go to the directory where the `omnisetup.sh` command is stored, and run:

```
cd directory/LOCAL_INSTALL ./omnisetup.sh
```

- If you have copied the whole DVD-ROM to *dvd_image_dir*, run the `omnisetup.sh` command without any parameters:

```
cd dvd_image_dir/LOCAL_INSTALL ./omnisetup.sh
```

3. `omnisetup.sh` prompts you to install or upgrade the HP AutoPass utility if you want to download and install passwords for the purchased licenses directly through the internet from the HP password delivery center web server. For more information on the AutoPass utility, refer to the HP AutoPass online Help. It is recommended to install AutoPass.

If AutoPass is installed on MC/ServiceGuard, it must be installed or upgraded on all nodes.

When prompted, press **Return** to install or upgrade AutoPass. If you do not want to install or upgrade AutoPass, enter **n**.

After the A.05.10, A.05.50 or A.06.00 version of Data Protector is detected, the upgrade procedure is automatically started. If you want to perform a clean installation (the database of previous version will be deleted), uninstall the old version and restart the installation.

For details about installation, refer to “[Installing a UNIX Cell Manager](#)” on page 43 and “[Installing Installation Servers for UNIX](#)” on page 61.

4. If you are upgrading from Data Protector A.05.10 and have Windows clients in the cell, you will be informed that conversion of file names in the IDB will be performed. The IDB conversion is necessary to correctly handle file names with international characters. Refer to “[Conversion of file names in the IDB](#)” on page 279 for details.

As soon as the procedure is completed, you can start using Data Protector.

For the description of the `omnisetup.sh` command, refer to the `README` file located in the `Mount_point/LOCAL_INSTALL` directory on the DVD-ROM or *HP Data Protector command line interface reference* located in the `Mount_point/DOCS/C/MAN` directory on the DVD-ROM.

What's next?

Once the Cell Manager and Installation Server systems are upgraded, check if you have to apply any modifications to your configuration files. Refer to “[Checking configuration changes](#)” on page 264.

Upgrading an Installation Server

The HP-UX, Solaris, or Linux Installation Server is upgraded automatically when the `omnisetup.sh` command is run.

On HP-UX, this command directly upgrades the existing package set using the `swinstall` utility. On Solaris, this command removes the existing package set using

the `pkgrm` utility and installs new packages using the `pkgadd` utility. On Linux, this command directly upgrades the existing package set using `rpm`.

If the Installation Server is installed with client components, it will be removed by the `omnisetup.sh` command. In this case, install a new Installation Server depot using the `omnisetup.sh -IS` command, and then re-import the upgraded Installation Server. For details, refer to “[Importing an installation server to a cell](#)” on page 210.

 **IMPORTANT:**

You cannot upgrade the Installation Server unless you upgraded the Cell Manager first.

Upgrade procedure

To upgrade the HP-UX, Solaris, or Linux Installation Server to Data Protector A.06.10, follow the procedure described below:

1. Insert and mount the UNIX installation DVD-ROM to a mount point.

For example:

```
mkdir /dvdrom mount /dev/c0d0t0 /dvdrom
```

Optionally, to install Data Protector from a depot on the disk, perform the following:

- To copy the `DP_DEPOT`, and `LOCAL_INSTALL` directories, where the installation files are stored, on your local disk, proceed as follows:

```
mkdir directory
```

```
cp -r /dvdrom/platform_dir/DP_DEPOT directory
```

```
cp -r /dvdrom/platform_dir/AUTOPASS directory
```

```
cp -r /dvdrom/LOCAL_INSTALL directory
```

Where *platform_dir* depends on the operating system and processor platform on which you upgrade Data Protector:

```
hpux_ia          HP-UX on IA-64 systems
```

```
hpux_pa          HP-UX on PA-RISC systems
```

```
solaris          Solaris systems
```

```
linux            Linux systems
```

- To copy the whole DVD-ROM to your local disk, run:

```
cp -r /dvdrom dvd_image_dir
```

2. Run the `omnisetup.sh` command.

To run this command from the DVD-ROM, execute:

```
cd /dvdrom/LOCAL_INSTALL ./omnisetup.sh
```

To start the installation from disk, perform one of the following steps:

- If you have copied the `DP_DEPOT`, and `LOCAL_INSTALL` directories to your local disk under *directory*, go to the *directory* where the `omnisetup.sh` command is stored, and run:

```
cd directory/LOCAL_INSTALL ./omnisetup.sh
```

- If you have copied the whole DVD-ROM to *dvd_image_dir*, run the `omnisetup.sh` command without any parameters:

```
cd dvd_image_dir/LOCAL_INSTALL ./omnisetup.sh
```

As soon as the procedure is completed, you can start using Data Protector.

For the description of the `omnisetup.sh` command, refer to the `README` file located in the `Mount_point/LOCAL_INSTALL` directory on the DVD-ROM or *HP Data Protector command line interface reference* located in the `Mount_point/DOCS/C/MAN` directory on the DVD-ROM.

What's next?

Once the Installation Server system is upgraded, check if you have to apply any modifications to your configuration files. Refer to "[Checking configuration changes](#)" on page 264.

Upgrading the Windows Cell Manager and Installation Server

When the previous version of Data Protector is detected, the same component set as installed is assumed by the operating system (without obsolete components). The existing package set is removed and the new package set is installed as for a new (clean) installation.

The Windows Installation Server is upgraded automatically during the upgrade procedure if it is installed on the same system as the Cell Manager. The old Installation Server depot is removed and if the `Installation Server` component is selected during the installation, the new Installation Server depot is copied to its place.

If the Installation Server is installed together with the Data Protector client, and this client is upgraded remotely (using the Data Protector GUI), the Installation Server is upgraded as well.

 **IMPORTANT:**

Re-import the upgraded Installation Server after the installation procedure has finished. For details, refer to [“Importing an installation server to a cell”](#) on page 210.

 **NOTE:**

If you want to upgrade your Windows operating system from Windows NT to a newer version of Windows, first upgrade the operating system and then upgrade the previous version of the product to Data Protector A.06.10. For details, refer to [“Upgrading from Windows NT to newer version of Windows”](#) on page 289.

Microsoft Cluster Server

The upgrade procedure for the Cell Manager, running in the Microsoft Cluster Server environment, is different from the upgrade procedure for the Cell Manager not configured for use with Microsoft Cluster Server. The detailed steps you need to follow are described in [“Upgrading the Cell Manager configured on Microsoft Cluster Server”](#) on page 304.

Upgrade procedure

To upgrade the Windows Cell Manager and Installation Server to Data Protector A.06.10, follow the procedure described below:

1. Insert the Windows installation DVD-ROM and run the `Windows_other` command. Setup detects the old Data Protector installation. Click **Next** to start the upgrade.
2. In the **Component Selection** page, the components previously installed on the system are selected. Note that you can change the component set by selecting or deselecting additional components. For a description of selected components, refer to the next step of the wizard. Click **Next**.

- 3. *Windows XP and Windows Server 2003 SP1 only:*** If Data Protector detects Windows Firewall on your system, the **Windows Firewall configuration** page is displayed. Data Protector setup will register all necessary Data Protector executables. By default, the *Initially, enable newly registered Data Protector binaries to open ports as needed* option is selected. If you do not want to enable Data Protector to open ports at the moment, deselect the option. However, note that for proper functioning of Data Protector, the executables must be enabled.

Click **Next**.

4. The component summary list is displayed. Click **Install** to perform the upgrade.

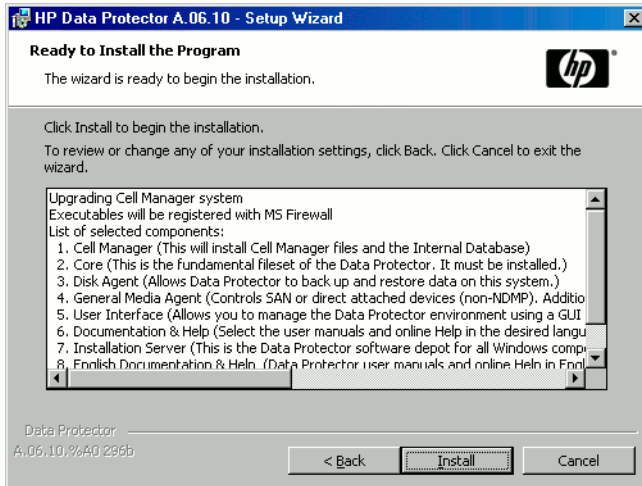

Figure 41 Component selection summary page

5. The **Installation status** page is displayed. Click **Next**.

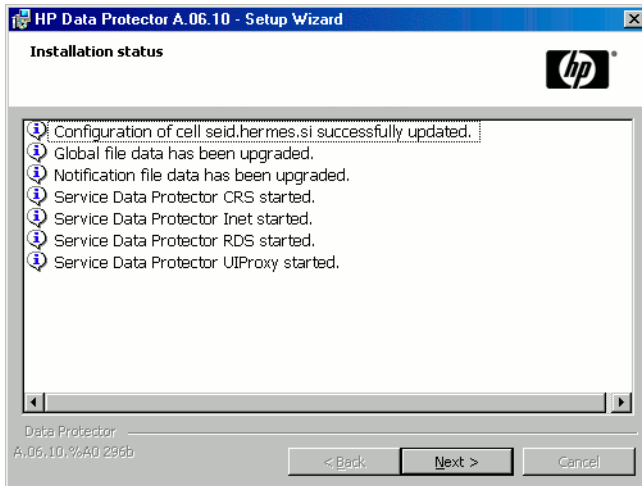

Figure 42 Installation status page

6. If you have UNIX clients in the cell, the **IDB Conversion** page will be displayed. Refer to “[Conversion of file names in the IDB](#)” on page 279.

7. This step is performed only for a Cell Manager upgrade. If the Installation Server installed on a client other than the Cell Manager is being upgraded, this step does not occur.

The Setup Wizard enables you to install or upgrade the HP AutoPass utility if you want to download and install passwords for the purchased licenses directly through the internet from the HP password delivery center web server. For more information on the AutoPass utility, refer to

[“Obtaining and installing permanent passwords using the HP AutoPass utility”](#) on page 323.

By default, the **Start AutoPass installation** or the **Upgrade AutoPass installation** option is selected. It is recommended to install the HP AutoPass utility. If you do not want to install or upgrade AutoPass, deselect the option.

To start using Data Protector immediately after setup, select **Start the Data Protector Manager GUI**.

To view the *HP Data Protector product announcements, software notes, and references*, select **Open the Product Announcements**.

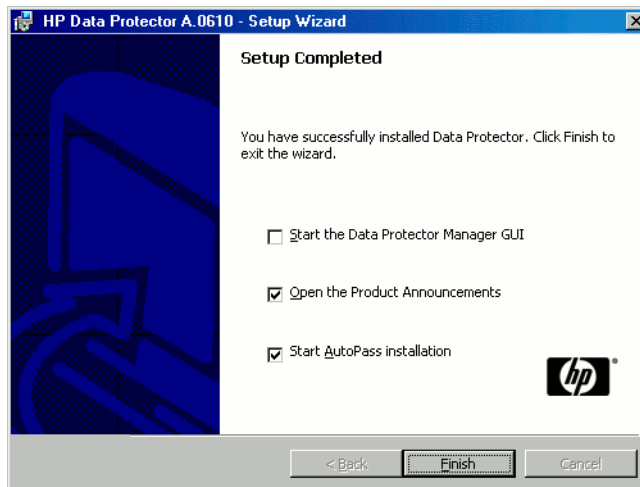

Figure 43 Selecting AutoPass for installation

8. Click **Finish**.

As soon as the procedure is completed, you can start using Data Protector.

What's next?

Once the Cell Manager and Installation Server systems are upgraded:

- The Data Protector IDB will be converted if you have UNIX clients in the cell to enable correct handling of non-ASCII characters in file names in the Data Protector. Refer to “[Conversion of file names in the IDB](#)” on page 279 for details about IDB conversion.
- Check if you have to apply any modifications to your configuration files. Refer to “[Checking configuration changes](#)” on page 264.

Checking configuration changes

Global options file

During the upgrade, the contents of the *old* global options file, residing in the `/etc/opt/omni/server/options` directory on UNIX Cell Manager, or in the `Data_Protector_home\Config\server\Options` directory on the Windows Cell Manager, are merged with the contents of the *new (default)* global options file on the Cell Manager:

- `/opt/omni/newconfig/etc/opt/omni/server/options` - UNIX Cell Manager
- `Data_Protector_home\NewConfig\Server\Options` - Windows Cell Manager

The *merged* file, which is named `global`, resides in the same location as the old one, `/etc/opt/omni/server/options` directory on UNIX Cell Manager, or in the `Data_Protector_home\Config\server\Options` directory on Windows Cell Manager, and is used by the upgraded version of the product. The *old* global options file is renamed to `global.1`, `global.2`, etc., depending on the number of upgrades performed.

The following applies when the merged file is created:

- Global options file variables that were active (uncommented) in the old file remain active in the merged file. The following comment, stating that the value of the variable was copied from the old file, is added to the merged file:

```
variable=value
# Data Protector A.06.10
# This value was automatically copied from previous version.
```

- Global options file variables, not used anymore, are commented (made inactive) in the merged file and added the following comment stating that the variable is no longer in use:

```
#variable=value
# Data Protector A.06.10
# This value is no longer in use.
```

- Variables with values, not supported anymore, are commented (made inactive) in the merged file. The following comment is added, containing a template (*variable_template*) and stating the previous value of this variable:

```
# variable=variable_template
# Data Protector A.06.10
# This variable cannot be transferred automatically.
# The previous setting was:
# variable=value
```

- Comments are not transferred to the newly merged file.

On Windows systems, the global options file is in the UNICODE format and can be edited using, for example, Notepad. After editing this file, make sure that you saved it in the UNICODE format.

The description of new options is in the merged global options file:

/etc/opt/omni/server/options/global on UNIX Cell Manager and *Data_Protector_home\Config\server\options\global* on the Windows Cell Manager. For details on how to use global options, see the *HP Data Protector troubleshooting guide*.

Manual steps

The following list summarizes the steps to be performed manually once the upgrade procedure has successfully completed:

- *omnirc* file

After upgrading the Cell Manager and Installation Server systems, you may want to edit the *omnirc* file. For the information on how to edit it, refer to “Using Omnirc Options” in the *HP Data Protector troubleshooting guide*.

- Command line

Refer to

“[Command line changes after upgrading to Data Protector A.06.10](#)” on page 447 for a list of commands that have been changed or provided with extended functionality. You have to check and modify the scripts that use the old commands. Refer to the corresponding man pages for usage synopsis.

- Default maximum size per DCBF directory

Default settings for already existing DCBF directories are not changed after an upgrade, only the newly created directories will have the default maximum size set to 16 GB. To manually change the maximum size of DC directory, use:

```
omnidbutil -modify_dcdir directory -maxsize size_in_MB
```

You need to change the settings when drives with large capacity, for example LTO 4, are used, and more than 10 million files are backed up on tape. In addition, make sure that the file system where DC directories reside supports large files.

What's next?

Once the Cell Manager and Installation Server(s) are installed and all required modifications implemented, it is recommended that you distribute the software to clients. Refer to ["Upgrading the clients"](#) on page 266.

Upgrading the clients

Upgrade sequence

For information about the sequence in which the client upgrade is performed, refer to ["Upgrade overview"](#) on page 249.

Upgrading clients remotely

For the procedure on how to upgrade the clients using the Installation Server, refer to ["Remote installation of Data Protector clients"](#) on page 77. On UNIX systems, you must upgrade the already present components before you add new components. After new components are added, the components from previous versions are not displayed by Data Protector. In this case, you have to reinstall them.

Upgrading clients locally

If you do not have an Installation Server installed on your network, or if for some reason you cannot distribute the Data Protector software to a client system, Data Protector clients can be upgraded locally.

To upgrade Windows clients locally, refer to ["Installing Windows clients"](#) on page 86. To upgrade UNIX clients locally, refer to ["Local installation of UNIX clients"](#) on page 146.

Novell NetWare

After upgrading any Novell NetWare client, you need to perform some additional steps that will enable you to perform any backup and restore of the NDS/eDirectory database. Refer to ["Local installation of the Novell NetWare clients"](#) on page 128 for details.

Linux clients

During upgrade of Linux clients, Data Protector binaries and configuration files are moved from `/usr/omni` to `/opt/omni` (binaries), or `/etc/opt/omni` (configuration files). Pre-exec and post-exec scripts are not moved to `/opt/omni`, but are copied to `/tmp/usr_omni`. You must manually copy them to `/opt/omni/lbin`.

If the `xinetd` service is used instead of `inetd`, the `/etc/xinetd.d/omni` file is *not* replaced and thus the settings remain unchanged. To check if the `xinetd` service is running, run the following command:

```
ps -e | grep xinetd
```

To replace your settings with the default Data Protector settings or to replace a corrupted file, remove the file and push any Data Protector software component from the Data Protector GUI. The `/etc/xinetd.d/omni` file is then installed with the default settings.

IMPORTANT:

By replacing the `/etc/xinetd.d/omni` file, your modifications are lost. To retain your modifications, create a backup copy and manually transfer the settings to the new file.

Upgrading clients configured on MC/ServiceGuard

If you are upgrading the client that uses MC/ServiceGuard, and if the Data Protector integration component to be upgraded is installed on the same node as the Cell Manager, first upgrade the physical nodes, and then perform the following:

1. Export the virtual host by running:

```
omnicc -export_host virtual_hostname
```

2. Re-import the virtual host by running:

```
omnicc -import_host virtual_hostname -virtual
```

Upgrading clients with integrations

If you are upgrading a Data Protector client that has the integration installed (such as Oracle, SAP R/3, Informix Server, Sybase, Microsoft Exchange Server, HP StorageWorks Disk Array XP, EMC Symmetrix, etc.), follow the steps described in sections below to successfully perform the upgrade:

- For instructions on how to upgrade the Oracle integration, refer to [“Upgrading the Oracle integration”](#) on page 268.
- For instructions on how to upgrade the SAP R/3 integration, refer to [“Upgrading the SAP R/3 integration”](#) on page 270.
- For instructions on how to upgrade the Informix Server integration, refer to [“Upgrading the Informix server integration on UNIX systems”](#) on page 271 and [“Upgrading the Informix server integration on Windows systems”](#) on page 272.
- For instructions on how to upgrade the Sybase integration, refer to [“Upgrading the Sybase integration on UNIX systems”](#) on page 274 and [“Upgrading the Sybase integration on Windows systems”](#) on page 275.
- For instructions on how to upgrade Microsoft Exchange, Microsoft SQL, HP StorageWorks Disk Array XP, EMC Symmetrix, etc., refer to [“Upgrading other integrations”](#) on page 278.

Upgrading the Oracle integration

The clients that have the Oracle integration installed are upgraded either locally by running the `omnisetup.sh -install oracle8` command on UNIX systems and the `setup.exe` command on Windows systems, or remotely by pushing the Oracle integration agent to the client using the Data Protector GUI. Note that on UNIX, if you are upgrading the client that does not reside on the Cell Manager, you do not need to specify the `-install oracle8` option. In this case, the setup will select the same components as installed on the system before the upgrade without issuing a prompt.

Data Protector MML

After upgrading a UNIX client with Oracle9i/10g, remove the symbolic link to the Data Protector MML because the link is no longer needed. For details, see the *HP Data Protector integration guide for Oracle and SAP*.

After upgrading a Windows client with Oracle8i, copy the file `Data_Protector_home\bin\orasbt.dll` to the `Oracle_home\bin` directory and restart the Oracle services. (TBD) .

New templates after upgrading

If you are upgrading from Data Protector A.05.10, the Oracle templates are replaced with newer versions. The new templates are located in the following directory:

`/opt/omni/newconfig/etc/opt/omni/server/dltemplates/lists/oracle8`
(on UNIX systems) or

Data_Protector_home\NewConfig\server\dltemplates\lists\oracle8
(on Windows systems).

To use the new templates, copy them after the upgrade to Data Protector A.06.10 to the /etc/opt/omni/server/dltemplates/lists/oracle8 (on UNIX systems) or

Data_Protector_home\Config\server\dltemplates\lists\oracle8
(on Windows systems) directory. If you wish to keep the old templates, save them under another name.

ZDB method configuration

Depending on whether the Oracle instance configuration file contains the `ORACLE_DBID` parameter or not, the ZDB method configuration file is set for Data Protector A.06.10 as follows:

- If the Oracle instance configuration file contains the `ORACLE_DBID` parameter (in Data Protector A.05.10 or A.05.50), the ZDB method configuration file is created for each database instance *during the upgrade*.

The Oracle ZDB method is not changed during the upgrade. For information on how to switch between the proxy-copy and backup set ZDB methods, refer to the *HP Data Protector zero downtime backup integration guide*.

Oracle ZDB upgrade

If you are upgrading from Data Protector A.05.10, the Oracle ZDB backup specifications are automatically upgraded at the end of a standard Oracle integration upgrade procedure.

The following steps are performed during a backup specification upgrade:

- The `OB2DMAP` and `OB2SMB` parameters are added to the *first* `RMAN ALLOCATE CHANNEL` command. The `OB2DMAP` parameter is set to the number of channels that were allocated before the upgrade. For example, with an `RMAN` script with 4 allocated channels, the `OB2DMAP` parameter will be set to 4.
- All `ALLOCATE CHANNEL` commands except the first one are removed from the scripts.
- If instant recovery is enabled, the `TABLESPACE` or `DATAFILES` backup objects are changed to `DATABASE` to allow only backups of the whole database.
- If the proxy copy backup method was used, all `RELEASE CHANNEL` commands are removed except the one referring to the first `ALOCATE CHANNEL` command.

Refer to the *HP Data Protector integration guide for Oracle and SAP* or *HP Data Protector zero downtime backup integration guide* for more details.

Configuring an Oracle instance for instant recovery

If the control files, recovery catalogs, or archive redo logs are located on the same volume group (if LVM is used) or source volume as the database files, you must either reconfigure the Oracle instance or set the `ZDB_ORA_INCLUDE_CF_OLF`, `ZDB_ORA_INCLUDE_SPF`, and `ZDB_ORA_NO_CHECKCONF_IR` `omnirc` variables. Refer to the *HP Data Protector zero downtime backup integration guide*.

Upgrading the SAP R/3 integration

The clients that have the SAP R/3 integration installed are upgraded either locally by running the `omnisetup.sh -install sap` command on UNIX systems and the `setup.exe` command on Windows systems, or remotely by pushing the SAP R/3 integration agent to the client using the Data Protector GUI. Note that on UNIX, if you are upgrading the client that does not reside on the Cell Manager, you do not need to specify the `-install sap` option. In this case, the setup will select the same components as installed on the system before the upgrade without issuing a prompt.

Data Protector MML

After upgrading a UNIX client with SAP R/3 running on Oracle9i/10g, remove the symbolic link to the Data Protector MML because the link is no longer needed. For details, see the *HP Data Protector integration guide for Oracle and SAP*.

After upgrading a Windows client with SAP R/3 running on Oracle8i, copy the file `Data_Protector_home\bin\orasbt.dll` to the `Oracle_home\bin` directory and restart the Oracle services. (TBD) This is necessary only if you plan to do backups and restores in the RMAN mode.

ORA_NLS_CHARACTERSET

After you upgrade a Data Protector A.05.10 or A.05.50 SAP R/3 client to Data Protector A.06.10, set the Data Protector `ORA_NLS_CHARACTERSET` parameter to the encoding used by the Oracle database. To set the parameter, use the Data Protector `util_cmd` command:

```
util_cmd -putopt SAP SAP_instance ORA_NLS_CHARACTERSET
'Oracle_encoding'
```

Example:

```
util_cmd -putopt SAP ICE ORA_NLS_CHARACTERSET 'US7ASCII'
```

SAP compliant ZDB sessions

SAP standards recommend that BRBACKUP is started on the backup system during ZDB sessions (SAP compliant ZDB sessions). Data Protector A.06.10 enables you to comply with these standards. First, configure the backup system as described in the SAP guide for Oracle (split mirror backup, software configuration) and install the Data Protector SAP R/3 Integration component on the backup system. Then, configure Data Protector for SAP compliant ZDB sessions as described in the *HP Data Protector zero downtime backup integration guide*.

Configuring an Oracle instance for instant recovery

If the control files, recovery catalogs, or archive redo logs are located on the same volume group (if LVM is used) or source volume as the database files, you have three options:

- Reconfigure the Oracle instance.
- Set the `ZDB_ORA_INCLUDE_CF_OLF`, `ZDB_ORA_INCLUDE_SPF`, and `ZDB_ORA_NO_CHECKCONF_IR` omnirc variables.
- Configure Data Protector to start BRBACKUP on the backup system (SAP compliant ZDB sessions).

For details , see the *HP Data Protector zero downtime backup integration guide*.

Upgrading the Informix server integration on UNIX systems

When upgrading the Informix Server integration from Data Protector A.05.10 to Data Protector A.06.10, there are, depending on the environment, three upgrade procedures:

Procedure 1

If the Informix Server client *does not reside* on the same system as the Cell Manager and it *is not configured* as a Data Protector cluster aware client, the Data Protector Informix Server configuration parameters are automatically moved from a Data Protector Informix Server client to the Cell Manager during the upgrade. No reconfiguration of the Informix Server databases is needed after the upgrade.

Upgrade the client either locally by running the `omnisetup.sh` command or remotely by pushing the Informix Server integration agent to the client using the Data Protector GUI.

Procedure 2

If the Informix Server client *does not reside* on the same system as the Cell Manager and it *is configured* as a Data Protector cluster aware client, the Data Protector Informix Server configuration parameters are automatically moved from the Data Protector Informix Server client to the Cell Manager during the upgrade. After the upgrade, the Informix Server databases must be reconfigured.

1. Upgrade the client either locally by running the `omnisetup.sh` command or remotely by pushing the Informix Server integration agent to the client using the Data Protector GUI.
2. Configure the Informix Server databases using the Data Protector GUI or CLI as described in the *HP Data Protector integration guide*.

Configure the Informix Server databases using the virtual hostname of Informix Server.

Procedure 3

If the Informix Server client *resides* on the same system as a *cluster-aware Cell Manager* and it *is either configured or not configured* as a Data Protector cluster aware client, the Data Protector Informix Server configuration parameters are not automatically moved from the Data Protector Informix Server client to the Cell Manager during the upgrade. After the upgrade, the Informix Server databases must be reconfigured.

1. Upgrade the client either locally by running the `omnisetup.sh` command or remotely by pushing the Informix Server integration agent to the client using the Data Protector GUI.
2. Configure the Informix Server databases using the Data Protector GUI or CLI as described in the *HP Data Protector integration guide*.

Upgrading the Informix server integration on Windows systems

When upgrading the Informix Server integration from Data Protector A.05.10 to Data Protector A.06.10, there are, depending on the environment, three upgrade procedures:

Procedure 1

If the Informix Server client *does not reside* on the same system as the Cell Manager and it *is not configured* as a Data Protector cluster aware client, the Data Protector Informix Server configuration parameters are automatically moved from the Data Protector Informix Server client to the Cell Manager during the upgrade. No reconfiguration of the Informix Server databases is needed after the upgrade.

Upgrade the client either locally by running the **setup.exe** command or remotely by pushing the Informix Server integration agent to the client using the Data Protector GUI.

Procedure 2

If the Informix Server client *does not reside* on the same system as the Cell Manager and it *is configured* as a Data Protector cluster aware client, the Data Protector Informix Server configuration parameters are automatically moved from the Data Protector Informix Server client to the Cell Manager during the upgrade. After the upgrade, the Informix Server databases must be reconfigured.

1. Upgrade the client either locally by running the **setup.exe** command or remotely by pushing the Informix Server integration agent to the client using the Data Protector GUI.
2. Configure the Informix Server databases using the Data Protector GUI or CLI as described in the *HP Data Protector integration guide*.

Configure the Informix Server databases using the virtual hostname of Informix Server.

Procedure 3

If the Informix Server client *resides* on the same system as a *cluster-aware Cell Manager* and it *is either configured or not configured* as a Data Protector cluster aware client, the Data Protector Informix Server configuration parameters are not automatically moved from the Data Protector Informix Server client to the Cell Manager during the upgrade. After the upgrade, the Informix Server databases must be reconfigured.

1. Upgrade the client either locally by running the **setup.exe** command or remotely by pushing the Informix Server integration agent to the client using the Data Protector GUI.
2. Configure the Informix Server databases using the Data Protector GUI or CLI as described in the *HP Data Protector integration guide*.

Upgrading the Sybase integration on UNIX systems

When upgrading the Sybase integration from Data Protector A.05.10 to Data Protector A.06.10, there are, depending on the environment, three upgrade procedures:

Procedure 1

If the Sybase client *does not reside* on the same system as the Cell Manager and it *is not configured* as a Data Protector cluster aware client, the Data Protector Sybase configuration parameters are automatically moved from the Data Protector Sybase client to the Cell Manager during the upgrade. No reconfiguration of the Sybase Server is needed after the upgrade.

Upgrade the client either locally by running the `omnisetup.sh` command or remotely by pushing the Sybase integration agent to the client using the Data Protector GUI.

Procedure 2

If the Sybase client *does not reside* on the same system as the Cell Manager and it *is configured* as a Data Protector cluster aware client, the Data Protector Sybase configuration parameters are automatically moved from the Data Protector Sybase client to the Cell Manager during the upgrade. After the upgrade, the Sybase Server must be reconfigured.

1. Upgrade the client either locally by running the **omnisetup.sh** command or remotely by pushing the Sybase integration agent to the client using the Data Protector GUI.
2. Configure the Sybase client using the Data Protector GUI or CLI as described in the *HP Data Protector integration guide*.

Configure the Sybase Server using the virtual hostname of the Sybase Server.

Procedure 3

If the Sybase client *resides* on the same system as a *cluster-aware Cell Manager* and it *is either configured or not configured* as a Data Protector cluster aware client, the Data Protector Sybase configuration parameters are not automatically moved from the Data Protector Sybase client to the Cell Manager during the upgrade. After the upgrade, the Sybase Server must be reconfigured.

1. Upgrade the client either locally by running the **omnisetup.sh** command or remotely by pushing the Sybase integration agent to the client using the Data Protector GUI.

2. Configure the Sybase Server using the Data Protector GUI or CLI as described in the *HP Data Protector integration guide*.

If the Sybase Server is configured as a Data Protector cluster aware client, configure it using the virtual hostname of the Sybase Server.

If the Sybase Server is not configured as a Data Protector cluster aware client, configure it using the hostname of the Sybase Server.

Upgrading the Sybase integration on Windows systems

When upgrading the Sybase integration from Data Protector A.05.10 to Data Protector A.06.10, there are, depending on the environment, three upgrade procedures:

Procedure 1

If the Sybase client *does not reside* on the same system as the Cell Manager and it *is not configured* as a Data Protector cluster aware client, the Data Protector Sybase configuration parameters are automatically moved from the Data Protector Sybase client to the Cell Manager during the upgrade. No reconfiguration of the Sybase Server is needed after the upgrade.

Upgrade the client either locally by running the **setup.exe** command or remotely by pushing the Sybase integration agent to the client using the Data Protector GUI.

Procedure 2

If the Sybase client *does not reside* on the same system as the Cell Manager and it *is configured* as a Data Protector cluster aware client, the Data Protector Sybase configuration parameters are automatically moved from the Data Protector Sybase client to the Cell Manager during the upgrade. After the upgrade, the Sybase Server must be reconfigured.

1. Upgrade the client either locally by running the **setup.exe** command or remotely by pushing the Sybase integration agent to the client using the Data Protector GUI.
2. Configure the Sybase client using the Data Protector GUI or CLI as described in the *HP Data Protector integration guide*.

Configure the Sybase Server using the virtual hostname of the Sybase SQL Server.

Procedure 3

If the Sybase client *resides* on the same system as a *cluster-aware Cell Manager* and it is *either configured or not configured* as a Data Protector cluster aware client, the Data Protector Sybase configuration parameters are not automatically moved from the Data Protector Sybase client to the Cell Manager during the upgrade. After the upgrade, the Sybase Server must be reconfigured.

1. Upgrade the client either locally by running the `setup.exe` command or remotely by pushing the Sybase integration agent to the client using the Data Protector GUI.
2. Configure the Sybase client using the Data Protector GUI or CLI as described in the *HP Data Protector integration guide*.

If the Sybase Server is configured as a Data Protector cluster aware client, configure it using the virtual hostname of the Sybase Server.

If the Sybase Server is not configured as a Data Protector cluster aware client, configure it using the hostname of the Sybase Server.

Upgrading the HP StorageWorks EVA integration

Upgrading the HP StorageWorks EVA Integration consists of upgrading from the HP StorageWorks EVA Agent (legacy) to the HP StorageWorks EVA SMI-S Agent. This upgrade is needed due to the EVA Agent (legacy) obsolescence.

Successful completion of the upgrade procedure results in:

- Upgrading the backup specifications created by the EVA Agent (legacy).
- Transferring the information on the backup sessions from the EVADB to the SMISDB to enable their restore by the SMI-S Agent.
- Transferring the login and disk group rules defined for the EVA Agent (legacy) to the SMISDB.

For detailed information on the supported versions/releases of the dependent products, as well as for a list of the platforms on which the SMI-S Agent is supported, refer to the *HP Data Protector product announcements, software notes, and references*.

Prerequisites

- Make sure you meet the minimum requirements for the operating systems on which the SMI-S Agent is supported.
- There must be no running EVA backups. The upgrade procedure may cause the backup to fail; in this case, no session information will appear in the SMIDB and a restore from that session will not be possible.

- Start the agent upgrade only after the Cell Manager upgrade is completed.

Upgrade procedure

To upgrade from the HP StorageWorks EVA Agent (legacy) to the HP StorageWorks EVA SMI-S Agent, carry out the steps described below:

1. On the Cell Manager, run the `upgrade_cm_from_evaa` command to upgrade all EVADB entries to SMISDB entries. Execute this command only after the Cell Manager is completed.

The following information is transferred:

- Backup specifications and backup sessions (replicas) created by the EVA Agent (legacy).
- The login entries related to the EVA Management Appliance.

Consider the following:

Login

- If a login entry is already present in the SMISDB, no new entries are created for that Management Appliance.
- Login user/password are assumed to be the same between CV EVA and a SMI-S Provider.
- The SMISDB login entry will always use port 5988.

Disk group rules

- If a rule for a certain disk group is already present in the SMISDB, no updates are made.
- All disk group rules defined for the EVA Agent (legacy) are added at the end of the existing SMISDB disk group rules.

For information on the `upgrade_cm_from_evaa` command, see the *HP Data Protector command line interface reference*.

2. On the application system, run the `omnisetup.sh -install smisa` command on UNIX systems or the `setup.exe` command on Windows systems if you perform a local upgrade. If you upgrade remotely, push the EVA SMI-S Agent to the client using the Add Components GUI wizard and selecting HP StorageWorks EVA SMI-S Agent.

The pre-exec script checks if the EVAA package exists on the system. If the package is detected, the information about it is removed from the Cell Manager.

Along with uninstallation of the EVAA package, the information on the EVA backup sessions (replicas) created by the EVA Agent (legacy) is transferred from the EVADB to the SMISDB. It means that after the upgrade, you will be able to restore the backup sessions created by the EVA Agent (legacy) using the SMI-S Agent.

3. After you have upgraded the application system, you need to upgrade the backup system as well. The scheduled backup specifications will not work until both the application and the backup systems are successfully upgraded.
4. Manually verify the `omnirc` file to make sure that `omnirc` variables have been successfully upgraded.

Upgrading other integrations

If the Data Protector client has the Microsoft Exchange, Microsoft SQL, HP StorageWorks Disk Array XP, EMC Symmetrix or some other integration installed, upgrade such client either locally using the `omnisetup.sh -install component_list` command on UNIX systems and the `setup.exe` command on Windows systems, or remotely using the Data Protector GUI. For a list of the Data Protector component codes, refer to “[Local installation of UNIX clients](#)” on page 146. Note that if you are upgrading the client that does not reside on the Cell Manager, you do not need to specify the `-install component_list` option. In this case, the setup will select the same components as installed on the system before the upgrade without issuing a prompt.

Upgrading in a MoM environment

You can upgrade a MoM Environment sequentially. However, note the following limitations:

Limitations

- After upgrading the MoM Manager/CMMDB Server, you cannot perform a restore of a Data Protector A.05.10 or A.05.50 filesystem or integration from

the Data Protector A.06.10 MoM GUI. Therefore, use either the old MoM GUI for restore or upgrade the clients.

You can perform filesystem and integration *backup* of Data Protector A.05.10 or A.05.50 clients from the Data Protector A.06.10 MoM GUI.

- You cannot use **distributed file media format** with your file libraries until all Cell Managers have been upgraded to Data Protector A.06.10.

To upgrade your MoM environment to Data Protector A.06.10, proceed as follows:

1. Upgrade the MoM Manager/CMMDB Server to Data Protector A.06.10.

During the upgrade, Cell Managers in a MoM environment must not be operational. After the upgrade, the MoM Manager can still work with the old Cell Managers.

2. Upgrade each client Cell Manager in a MoM environment.

For the upgrade procedure, refer to

[“Upgrading the UNIX Cell Manager and Installation Server”](#) on page 253 and [“Upgrading the Windows Cell Manager and Installation Server”](#) on page 259.

3. Upgrade clients with configured devices.
4. Upgrade clients with application integrations.

After this part of the upgrade is finished, you can backup and restore filesystems and integrations with the Data Protector A.06.10 MoM GUI.

Conversion of file names in the IDB

Data Protector A.06.00 has improved handling and display of file names created with different locales on different platforms. This requires a conversion of the existing file names in the IDB for some specific cell configurations if you are upgrading from Data Protector A.05.10.

The conversion of file names in the IDB must be performed. Otherwise, the browsing and restore selection of file names containing non-ASCII characters depend on many factors. The probability of undesirable results is thus high.

The conversion is performed:

- On the UNIX Cell Manager as a part of post-upgrade backups of Windows clients.
- On the Windows Cell Manager as a background process after the upgrade of the Cell Manager.

You will be prompted, if it is needed to perform the IDB conversion.

Table 10 on page 280 (for Windows Cell Manager) and Table 11 on page 281 describe the impact of file name conversion on the Cell Manager if you are upgrading from Data Protector A.05.10.

Table 10 File name conversion impact on a Windows Cell Manager

	UNIX and Other Clients	Windows Clients
Needs IDB conversion	Yes. ¹	No.
Backup before the conversion, client not upgraded	Problematic. ² Any client with non-ASCII characters in backup specifications (trees, exclude lists, etc.) must be upgraded to Data Protector A.06.10. Data Protector logs all such clients in the Data Protector Event Log during upgrade to help you prioritize your upgrade tasks.	No problems.
Backup before the conversion, client upgraded to A.06.10	No problems. If a client is being backed up while the conversion is running and IDB data for this particular client is being converted, the backup will switch to <code>No log</code> mode for this session.	No problems.
Display of files for restore before the conversion, selecting non-ASCII file names/trees for restore	Problematic. ³ The correct display (and selection for restore) of non-ASCII characters in the Data Protector GUI is impossible until the file names in the IDB for this client are converted.	No problems.
Backup after the conversion	No problems. The client must be upgraded to Data Protector A.06.10.	No problems.
Display and restore of files after the conversion	No problems. The client must be upgraded to Data Protector A.06.10.	No problems.

	UNIX and Other Clients	Windows Clients
Disk Agent compatibility (earlier versions) ⁴	Data Protector A.05.10 = No, A.05.50 = YES ⁴ .	Data Protector A.05.10 = YES ⁴ , A.05.50.= YES. ⁴

Table 11 File name conversion impact on a UNIX Cell Manager

	UNIX and Other Clients	Windows Clients
Needs IDB conversion	No.	Yes. ¹
Backup during the conversion period, client not upgraded	No problems.	Problematic. ² Any client with non-ASCII characters in backup specifications (trees, exclude lists, etc.) must be upgraded to Data Protector A.06.10. Data Protector logs all such clients in the Data Protector Event Log to help you prioritize your upgrade tasks.
Backup during the conversion period, client upgraded to A.06.10	No problems.	No problems. Note that backing up Windows clients during the conversion period is required. IDB data for each client is automatically converted while the client is being backed up. You need to perform a full backup to convert all file names stored in the IDB for this client.
Display of files for restore before the conversion, selecting non-ASCII file names/trees for restore	No problems.	Problematic. ³ The correct display (and selection for restore) of non-ASCII characters in the Data Protector GUI is impossible unless a full backup is performed after the upgrade of the Cell Manager.
Backup after the conversion period	No problems.	No problems. The client must be upgraded to Data Protector A.06.10.

	UNIX and Other Clients	Windows Clients
Display and restore of files after the conversion	No problems.	No problems. The client must be upgraded to Data Protector A.06.10.
Disk Agent compatibility (earlier versions) ⁴	⁴ , A.05.10 = YES ⁴ , A.05.50.= YES ⁴	Data Protector A.05.10 = No, A.05.50 = YES ⁴

¹If the file name conversion is not performed, the number of file names in the Catalog Database (CDB) part of IDB will grow for the amount of file names with non-ASCII characters in file names being backed up. Files and directories that require conversion but have not been converted yet, cannot be selected for restore. You can restore them only by restoring a parent tree containing only ASCII characters to a temporary location.

²Restrictions do not apply if file names (trees) in the backup specification contain only ASCII characters. If so, all files and directories within a tree are backed up and their names are stored in the IDB correctly even if file names (trees) contain non-ASCII characters.

³Restrictions do not apply if the file name (tree) you are restoring contains only ASCII characters. Otherwise, you can restore them by restoring a parent tree containing only ASCII characters to a temporary location. All files and directories within such parent tree will be restored with their original file names (even if they are not displayed correctly in the Data Protector GUI) provided that they are restored to the original platform.

⁴Filesystem Disk Agent compatibility with the Data Protector A.06.10 Cell Manager. The support for Disk Agent from earlier versions is limited to 2 weeks. During this period, you should upgrade all clients in the cell.

Remarks

- Regardless of file name handling issues, when a file is backed up and restored, the original byte sequence of the file body is retained.
- File names consisting of 7 bit ASCII characters only are fully supported for all combinations of platforms for all components involved (Cell Manager, client, GUI). For non-ASCII characters in file names, specific setup and configuration is required for proper handling of file names.

IDB conversion can take quite some time and system resources to complete, depending on the size of the filename part of the IDB and your cell configuration. However, this will not affect the success of your backups or restores.

IDB conversion on a Windows Cell Manager

Introduction

This section applies only for Windows Cell Managers that have non-Windows clients in the cell and are being upgraded from Data Protector A.05.10. If you are upgrading from A.05.50, no conversion is needed.

IDB conversion will take some time, depending on the size of the IDB and the configuration of your cell, but it does not affect the success of your backups or restores. The conversion is performed as a background process in a single run for all non-Windows clients in the cell, while Data Protector is fully operational. It first converts all data for one client before proceeding with conversion of the next client's data. After it is finished, IDB conversion is complete and does not need to be performed again.

If the filenames do not include non-ASCII characters, the IDB conversion will still be run, but nothing will be changed in the IDB.

IDB conversion will not affect the IDB size.

How IDB conversion is performed

After the upgrade of Data Protector is finished, the Data Protector Setup Wizard offers you conversion of filenames in the IDB.

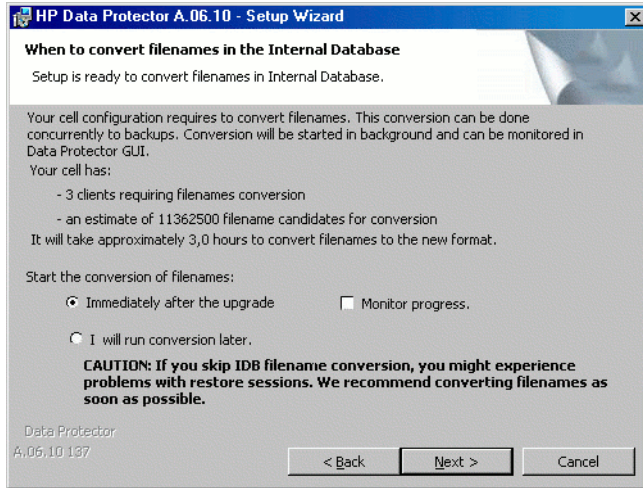

Figure 44 IDB conversion after upgrade

You are given a rough estimate of how long the IDB conversion will take to finish. The estimate is based on the number of non-Windows clients in the cell and the number of their files stored in the IDB.

If you postpone the conversion to later, you will have to run the IDB conversion manually using the `omnidbupgrade` command. Refer to *HP Data Protector command line interface reference* for details.

 **NOTE:**

It is recommended to perform IDB conversion and to upgrade the Disk Agents on clients as soon as possible.

You can check the status of the IDB conversion (data for which clients has already been converted) in the Data Protector GUI in the Monitor Context.

Backup during conversion

Backups during IDB filename conversion are possible, because the conversion runs in the background, while Data Protector is fully operational.

If the client's data in the IDB is being converted during the backup of this client then the backup is done using the `NO LOG` option (and hence no information about backed up files and directories is logged to the IDB for this client in this session).

Restore during conversion

Restore *during* the conversion of file names is possible. However, only restores of entire objects or selections of directories/files from non-Windows systems, containing 7-bit ASCII characters, are safe.

If files or directories you have selected for restore to a specific client contain non-ASCII characters (and originate from a non-Windows platform), wait for the IDB conversion of that client's data to finish. The Disk Agent on that client must be upgraded prior to the restore.

Backup and restore after IDB conversion

After the whole IDB has been converted and all Disk Agents on all clients in the cell have been upgraded to A.06.10 version, backup and restore will operate normally.

IDB conversion on a UNIX Cell Manager

Introduction

This section applies only for UNIX Cell Managers with Windows clients in the cell are being upgraded from Data Protector A.05.10. If you are upgrading from A.05.50, no conversion is needed.

IDB conversion takes some time, depending on the size of the IDB and the configuration of your cell, but it will not affect the success of your backups or restores. The conversion is being performed as a background process during backups of Windows clients in the cell for a specific period. After a full backup of all filesystem backup objects of all Windows clients in the cell is performed, IDB conversion is complete and does not need to be performed again.

The conversion of filenames in the IDB during backups will by default run for one month, which is defined by the `ConvertFilenamesInIDBDuringBackup` global option. See the *HP Data Protector troubleshooting guide* for details on how to edit the global options file.

Impact on performance

The conversion of file names in the IDB has impact on performance. While the conversion is running (the `ConvertFilenamesInIDBDuringBackup` global option is enabled), a backup of a Windows client is slower until the first full backup of the client is performed. Please refer to the *HP Data Protector product announcements, software notes, and references* for detailed information.

Limitations

Consider the following limitations:

- It is possible that a file, backed up with the previous version of Data Protector and stored in the IDB using the old encoding, has been deleted from the client before the IDB conversion. In this case, the filename will not be converted in the IDB. The same situation occurs if no backups have been performed during the conversion period (defined by the `ConvertFileNamesInIDBDuringBackup` global option). This makes the restore of such file more difficult if it uses non-ASCII characters in the filename. See the *HP Data Protector troubleshooting guide* for a workaround.
- For other limitations, refer to [Table 11](#) on page 281.

Upgrading from the Single Server Edition

You can perform the upgrade from one of the following:

- From earlier versions of the Single Server Edition (SSE) to Data Protector A.06.10 Single Server Edition. For details, refer to [“Upgrading from earlier versions of SSE to Data Protector A.06.10 SSE”](#) on page 286.
- From Data Protector A.06.10 Single Server Edition to Data Protector A.06.10. For details, refer to [“Upgrading from Data Protector A.06.10 SSE to Data Protector A.06.10”](#) on page 286.

Upgrading from earlier versions of SSE to Data Protector A.06.10 SSE

The upgrade procedure from earlier versions of SSE to Data Protector A.06.10 SSE is the same as the upgrade procedure from earlier versions of Data Protector to Data Protector A.06.10. For the information, refer to [“Upgrading from Data Protector A.05.10, A.05.50, and A.06.00”](#) on page 252.

Upgrading from Data Protector A.06.10 SSE to Data Protector A.06.10

Licenses

You need to have a license to perform the upgrade from Data Protector A.06.10 Single Server Edition to Data Protector A.06.10. For details about licensing, refer to [Chapter 5](#) on page 309.

The upgrade from Data Protector A.06.10 Single Server Edition to Data Protector A.06.10 is offered for two possible scenarios:

- If you have the Data Protector Single Server Edition installed on one system (Cell Manager) only. Refer to “[Upgrading the Cell Manager](#)” on page 287.
- If you have the Data Protector Single Server Edition installed on multiple systems and you want to merge these cells. Refer to “[Upgrading from multiple installations](#)” on page 287.

 **NOTE:**

If you want to upgrade from a previous version of the Single Server Edition to a full Data Protector installation, first upgrade your Single Server Edition to the full installation of the same version level. To upgrade this full installation to Data Protector A.06.10, refer to “[Upgrading from Data Protector A.05.10, A.05.50, and A.06.00](#)” on page 252.

Upgrading the Cell Manager

To upgrade the Single Server Edition Cell Manager, do the following:

1. Remove the Single Server Edition license:
 - on Windows: `del Data_Protector_home\Config\server\Cell\lic.dat`
 - on UNIX: `rm /etc/opt/omni/server/cell/lic.dat`
2. Start the Data Protector GUI and add a permanent password.

Upgrading from multiple installations

To upgrade the Data Protector Single Server Edition installed on multiple systems, proceed as follows:

1. Select one of the existing Single Server Edition systems to be the new Cell Manager. Refer to “[Choosing the Cell Manager system](#)” on page 37.

2. Upgrade the selected Cell Manager by performing the following:
 - a. Remove the Single Server Edition license:

```
del Data_Protector_home\Config\server\Cell\lic.dat (on Windows systems) or  
rm /etc/opt/omni/server/cell/lic.dat (on UNIX systems)
```
 - b. Start the Data Protector GUI and add a permanent password.
3. Import the other Single Server Edition systems into the newly created Cell Manager system as clients using the GUI.
4. Uninstall the Data Protector Single Server Edition from the other systems. Refer to “[Uninstalling Data Protector software](#)” on page 231.
5. If needed, import the media to the new Cell Manager.

Perform this step if you intend to frequently restore from the media created on the other Single Server Edition systems. If the probability of these restores is relatively low, the `List from media` restore can be used. See the *online Help index: “importing, media”* for the information about importing media and details about the `List from media` restore.

Upgrading from HP StorageWorks Application Recovery Manager A.06.00

Overview

Application Recovery Manager is a scalable recovery software solution providing automated backup and recovery of Exchange and SQL application data designed to improve application availability with data recovery in minutes.

Data Protector A.06.10 supports the upgrade from Application Recovery Manager A.06.00 and supports all Application Recovery Manager A.06.00 features. The configuration and internal database are retained after upgrade.

Limitations

- Changing the Cell Manager platform is not supported in the A.06.10 release of Data Protector. Upgrades are only supported on the same Cell Manager platform (32-bit Windows to 32-bit Windows or 64-bit Windows to 64-bit Windows).

Upgrade procedure

The procedures for upgrading from Application Recovery Manager A.06.00 and older versions of Data Protector to Data Protector A.06.10 are identical. See [Upgrading the Cell Manager](#) and [Upgrading the clients](#).

Internal database backup after the upgrade

Old backups of the internal database created with `dbtool.pl` are not usable with Data Protector. You must configure a new backup specification to back up the internal database and configuration. See the online Help index: "IDB, configuring backups".

Apart from using a tape device, the IDB backup in Data Protector differs from Application Recovery Manager in the following details:

- the Data Protector services are not stopped during the backup as with `dbtool.pl`
- the VSS database is not backed up

Upgrade of backup specifications

Backup specification in Application Recovery Manager do not contain tape devices. After the upgrade to Data Protector, the backup specifications can be used only for ZDB to disk. To use tape functionality (ZDB to disk+tape, ZDB to tape), you must reconfigure the backup specifications, specifying the tape device.

Changes in omnib usage

If no options are specified, Data Protector defaults to ZDB to disk+tape. Application Recovery Manager backup sessions started from the CLI using the `omnib` command will therefore fail due to missing tape devices. To keep your existing backup specifications without reconfiguring them for ZDB to disk+tape, use the `-disk_only` option to run ZDB to disk.

Upgrading from Windows NT to newer version of Windows

If you have the Cell Manager installed on the Windows NT system, you must upgrade the operating system to a newer version, as Windows NT is not supported by Data Protector A.06.10 as a Cell Manager platform.

If you want to upgrade your operating system from Windows NT to a newer version of Windows, you have to consider the impact of this upgrade on Data Protector.

If you have Data Protector A.05.10 Cell Manager installed on Windows NT, and you want to upgrade it to Data Protector A.06.10, perform the upgrade in the following sequence:

1. Upgrade the operating system from Windows NT to a newer version of Windows. For more information, refer to Windows documentation.
2. Upgrade the Data Protector A.05.10 Cell Manager to Data Protector A.06.10. For the procedure, refer to [“Upgrading from Data Protector A.05.10, A.05.50, and A.06.00”](#) on page 252.

Upgrading from Solaris 8 to Solaris 9

If you have Data Protector A.06.10 Disk Agent (DA) installed on Solaris 8, and you want to upgrade the operating system to Solaris 9, consider the impact of this upgrade on Data Protector. It is recommended to replace the generic Solaris DA installed on the system with the Solaris 9 DA to ensure proper operation of Data Protector and enable advanced backup options for Solaris 9, such as backup of extended attributes.

Perform the upgrade in the following sequence:

1. Upgrade the operating system from Solaris 8 to Solaris 9. For more information, refer to Solaris documentation.
2. Remotely install the Disk Agent on the upgraded system using an Installation Server. This will replace the generic Solaris Disk Agent with Solaris 9 Disk Agent. Refer to [“Remote installation of Data Protector clients”](#) on page 77 or to `ob2install` man page.

Migrating from HP-UX 11.x (PA-RISC) to HP-UX 11.23/11.31 (IA-64)

This section describes the procedure for migrating your existing Cell Manager from a PA-RISC architecture based HP-UX 11.x system to an HP-UX 11.23/11.31 system for the Intel Itanium 2 (IA-64) architecture.

Limitations

For details on supported operating system versions, platforms, processor architectures and Data Protector components as well as required patches, general limitations, and

installation requirements, see the *HP Data Protector product announcements, software notes, and references*.

- The migration is supported only from the Data Protector A.06.10 Cell Manager on a PA-RISC based HP-UX 11.x system.
- For the supported combinations of MoM configurations, refer to “[MoM specifics](#)” on page 294.

Prerequisite

- Before the migration, the Data Protector Cell Manager on a PA-RISC architecture based HP-UX 11.x system must be upgraded to Data Protector A.06.10.

Recommendation

- It is recommended to perform the conversion of file names in the IDB prior to migration. Refer to “[Conversion of file names in the IDB](#)” on page 279.

Licenses

The new Cell Manager (IA-64 system) will have a different IP address as the old Cell Manager, therefore you should apply for the licenses migration prior to the migration. For a limited amount of time, licenses on both system will be operational. If licenses are based on an IP range and the new Cell Manager’s IP address is within this range, no license reconfiguration is necessary. Refer to “[License migration to Data Protector A.06.10](#)” on page 362 for details.



NOTE:

On Cell Manager platforms where the original Data Protector GUI is not supported, you can use the Data Protector Java GUI or install the original Data Protector GUI on a system where it is supported. Use the `omniusers` command to create a remote user account on the new Cell Manager. You can then use this user account on any system with the Data Protector GUI installed to start the GUI and connect to the new Cell Manager. Refer to the `omniusers` man page.

Migration procedure

Perform the migration procedure as follows:

1. Install a Data Protector client on the IA-64 system and import it to the old Cell Manager's cell. If you are planning to configure Data Protector in a cluster, install the client on the primary node. Refer to ["Installing HP-UX clients"](#) on page 93.
2. Run the following command on the *old* Cell Manager to add the hostname of the IA-64 system to the list of trusted hosts on secured clients:
omnigrate.pl -prepare_clients *New_CM_Name*, where the *New_CM_Name* is the client name of the IA-64 system from the previous step.
For more information about trusted hosts and securing Data Protector clients, refer to ["Securing clients"](#) on page 219 and ["Host trusts"](#) on page 228.
3. Back up the IDB. Make sure that the used media can later be accessed on the new Cell Manager system. Refer to the online Help index keyword "IDB backup".
4. Restore the IDB to a temporary location on the IA-64 system. Refer to online Help index keyword "IDB restore".
5. Uninstall the Data Protector client from the IA-64 system. Refer to ["Uninstalling a Data Protector client"](#) on page 232.
6. Install Data Protector Cell Manager on the IA-64 system. If you are planning to configure Data Protector in a cluster, install the Cell Manager on the primary node as a *standalone* Cell Manager (not cluster aware). Refer to ["Installing the Data Protector Cell Manager \(CM\) and Installation Server\(s\) \(IS\)"](#) on page 42.
7. If you changed the default Data Protector lnet port on the old Cell Manager, set the same lnet port also on the new Cell Manager. Refer to ["Changing the default port number"](#) on page 399.
8. Move the restored IDB (residing in a temporary location on the new Cell Manager), and configuration data to the same location on the new Cell Manager as it was on the old Cell Manager. Refer to online Help index keyword "IDB restore".

If the old Cell Manager was cluster-aware, comment out the `SHARED_DISK_ROOT` and `CS_SERVICE_HOSTNAME` variables in the `/etc/opt/omni/server/sg/sg.conf` file. This is necessary even if the new Cell Manager will be cluster-aware.

9. To migrate the IDB and clients to the new Cell Manager, and to reconfigure the Cell Manager's settings, perform the following steps on the *new* Cell Manager:
 - If you want to configure a standalone IA-64 Cell Manager, run the `omnimigrate.pl -configure` command. Refer to the `omnimigrate.pl man` page.
 - If you want to configure a cluster-aware IA-64 Cell Manager:
 - a. Run the `omnimigrate -configure_idb` command to configure the IDB from the old Cell Manager for use on the new Cell Manager. Refer to the `omnimigrate.pl man` page.
 - b. Run the `omnimigrate -configure_cm` command to reconfigure the configuration data transferred from the old Cell Manager for use on the new Cell Manager. Refer to the `omnimigrate.pl man` page.
 - c. Export the old virtual server from the cell by running the `omnicc -export_host Old_CM_Name`.
 - d. Configure the primary and secondary Cell Manager. Refer to the online Help index keyword "MC/ServiceGuard integration configuring".
 - e. Run the `omnimigrate -configure_clients` command to migrate the clients from the old Cell Manager to the new Cell Manager. Note that the old Cell Manager will keep the clients in the configuration files although it will not be their Cell Manager anymore.

**NOTE:**

If the `/etc/opt/omni/server` directory is located on the shared cluster volume, the configuration changes made by the `omnimigrate.pl` script will affect all nodes in the cluster.

**NOTE:**

The old Cell Manager will automatically become a client in the new cell. You can uninstall the Cell Manager component from the old Cell Manager, because it is not necessary anymore. Refer to "[Changing Data Protector software components](#)" on page 245.

10. Configure the licenses on the new Cell Manager. Refer to "[Data Protector A.06.10 product structure and licenses](#)" on page 347.

11. Create a remote user account on the new Cell Manager and use the newly created user account on any other system with the Data Protector GUI installed to start the GUI and connect to the Cell Manager. Refer to the `omniusers` man page for details.
12. Additional steps are required if the following is true:
 - Your cell is a part of the MoM environment. Refer to “[MoM specifics](#)” on page 294
 - Your cell works across a firewall. Reconfigure all firewall related settings on the new Cell Manager. Refer to online Help index keyword “firewall environments”.
 - You want to have an Installation Server on your new Cell Manager. Refer to “[Installation Server specifics](#)” on page 295.

MoM specifics

If the new Cell Manager will be configured in the MoM, additional steps are required after the basic migration procedure has been completed. The required steps depend on the configuration of the MoM for the old and new Cell Managers in your environment. The supported combinations are:

- The old Cell Manager was a MoM client; the new Cell Manager will be a MoM client of the same MoM Manager.

Perform the following steps:

1. On the MoM Manager, export the old Cell Manager from the MoM Manager cell and import the new Cell Manager. Refer to the online Help index keyword “client systems exporting”.
2. Add the MoM administrator to the users list on the new Cell Manager. Refer to the online Help index keyword “MoM administrator, adding”.

- The old Cell Manager was a MoM Manager; the new Cell Manager will be a MoM Manager.

If the old MoM Manager was the only client in the MoM, no action is necessary. Otherwise, perform the following steps:

1. On the old MoM Manager (the old Cell Manager), export all MoM clients.
2. On the new MoM Manager (the new Cell Manager), import all MoM clients.
3. Add the MoM administrator to the users list on all MoM clients.

 **NOTE:**

On Cell Manager platforms where the original Data Protector GUI is not supported, you can use the Data Protector Java GUI or install the original Data Protector GUI on a system where it is supported. Use `omniusers` command to create a remote user account on the new Cell Manager. You can then use this user account on any system with the Data Protector GUI installed to start the GUI and connect to the new Cell Manager. Refer to the `omniusers` man page.

Installation Server specifics

The migration of the Installation Server is not done as part of the Cell Manager migration. If Installation Server is installed on your old Cell Manager, it will not be migrated to the new Cell Manager and will stay the Installation Server for your cell.

If you want to use the new Cell Manager also as an Installation Server, install the Installation Server component on the new Cell Manager after the migration and import it in the cell. Refer to the online Help index keyword “Installation Server”.

Migrating from 32-bit/64-bit Windows to 64-bit Windows/Windows Server 2008

This section describes the procedure for migrating your existing Cell Manager from a 32-bit Windows system to a 64-bit Windows system, or from a 64-bit Windows system to a 64-bit Windows Server 2008 system.

Limitations

See the HP Data Protector product announcements, software notes, and references for details on supported operating system versions, platforms, processors and Data Protector components as well as required patches, general limitations, and installation requirements.

Prerequisite

- Before the migration, the Data Protector Cell Manager on a 32-bit Windows system must be upgraded to Data Protector A.06.10.

Recommendation

- In the case of upgrade from Data Protector A.05.10, it is recommended to perform the conversion of file names in the IDB prior to migration. See [“Conversion of file names in the IDB”](#) on page 279.

Licenses

The new Cell Manager will have a different IP address than the old Cell Manager, therefore you should apply for license migration prior to the migration. For a limited amount of time, licenses on both systems will be operational. If your licenses are based on an IP range and the new Cell Manager’s IP address is within this range, no license reconfiguration is necessary. See [“License migration to Data Protector A.06.10”](#) on page 362 for details.

Migration procedure

Perform the migration as follows:

1. Install a Data Protector client on the 64-bit Windows system or a 64-bit Windows Server 2008 system that will become your new Cell Manager. For details, see [“Installing Windows clients”](#) on page 86.
2. Import the system to the old Cell Manager’s cell.
3. On the *old* Cell Manager, add the hostname of the new Cell Manager to the list of trusted hosts on secured clients. From the directory `Data_Protector_home\bin`, run:

```
perl winomnigrate.pl -prepare_clients New_CM_Name
```

New_CM_Name is the client name of the new Cell Manager from the previous step. For details on `winomnigrate.pl`, see [HP Data Protector command line interface reference](#).

For more information about trusted hosts and securing Data Protector clients, see [“Securing clients”](#) on page 219 and [“Host trusts”](#) on page 228.

4. Back up the IDB. Make sure that the used media can later be accessed on the new Cell Manager system. See the online Help index: “IDB backup”.
5. Restore the IDB to a temporary location on the new Cell Manager. Depending on which option you choose for the IDB backup, you may have to configure the device and import the catalog from the appropriate media. Once the IDB backup object is in the IDB, you can restore the IDB in order to move the configuration data to the new system. See the online Help index: “IDB restore”.

6. Uninstall the Data Protector client from the new Cell Manager. See [“Uninstalling a Data Protector client”](#) on page 232.
7. Install Data Protector Cell Manager on the new Cell Manager. See [“Installing the Data Protector Cell Manager \(CM\) and Installation Server\(s\) \(IS\)”](#) on page 42.
8. If you changed the default Data Protector Inet port on the old Cell Manager, set the same Inet port on the new Cell Manager. See [“Changing the default port number”](#) on page 399.
9. Move the restored IDB (residing in a temporary location on the new Cell Manager) and configuration data to the same location on the new Cell Manager as it was on the old Cell Manager. Do not restart the Data Protector services. See the online Help index: “IDB restore”.

10. To migrate the IDB and clients to the new Cell Manager and to reconfigure the Cell Manager's settings, perform the following steps on the *new* Cell Manager:
 - Configure a standalone Cell Manager. From the directory `Data_Protector_home\bin`, run:
`perl.exe winomnimigrate.pl -configure`
 - To configure a cluster-aware Cell Manager:
 - a. From the directory `Data_Protector_home\bin`, run `perl.exe winomnimigrate.pl -configure_idb` to configure the IDB from the old Cell Manager for use on the new Cell Manager.
 - b. From the directory `Data_Protector_home\bin`, run `perl.exe winomnimigrate.pl -configure_cm` to reconfigure the configuration data transferred from the old Cell Manager for use on the new Cell Manager.
 - c. Export the old virtual server from the cell by running `omnicc -export_host Old_CM_Name`.
 - d. From the directory `Data_Protector_home\bin`, run `perl.exe winomnimigrate.pl -configure_clients` to migrate the clients from the old Cell Manager to the new Cell Manager. Note that the old Cell Manager will keep the clients in the configuration files although it will not be their Cell Manager anymore.

**NOTE:**

The old Cell Manager will automatically become a client in the new cell. You can uninstall the Cell Manager component from the old Cell Manager, because it is not necessary anymore. See [“Changing Data Protector software components”](#) on page 245.

11. If you installed the new 64-bit Cell Manager in a different directory than the one in which the old Cell Manager was installed, the internal links in the IDB still include the old Cell Manager paths. Manually add the new paths of the Detail Catalog Directories on the new Cell Manager using the Data Protector GUI. See the online Help index: [“creating DC directories”](#).
12. Configure the licenses on the new Cell Manager. See [“Data Protector A.06.10 product structure and licenses”](#) on page 347.

13. Additional steps are required if:

- Your cell is a part of the MoM environment. See “[MoM specifics](#)” on page 299.
- Your cell works across a firewall. Reconfigure all firewall related settings on the new Cell Manager. See the online Help index: “[firewall environments](#)”.
- You want to have an Installation Server on your new Cell Manager. See “[Installation Server specifics](#)” on page 299.

MoM specifics

If the new Cell Manager will be configured in the MoM, additional steps are required after the basic migration procedure has been completed. The required steps depend on the configuration of the MoM for the old and new Cell Managers in your environment. The supported combinations are:

- The old Cell Manager was a MoM client; the new Cell Manager will be a MoM client of the same MoM Manager.

Perform the following steps:

1. On the MoM Manager, export the old Cell Manager from the MoM Manager cell and import the new Cell Manager. See the online Help index: “[client systems, exporting](#)”.
2. Add the MoM administrator to the user list on the new Cell Manager. See the online Help index: “[MoM administrator, adding](#)”.

- The old Cell Manager was a MoM Manager; the new Cell Manager will be a MoM Manager.

If the old MoM Manager was the only client in the MoM, no action is necessary. Otherwise, perform the following steps:

1. On the old MoM Manager (the old Cell Manager), export all MoM clients.
2. On the new MoM Manager (the new Cell Manager), import all MoM clients.
3. Add the MoM administrator to the user list on all MoM clients.

Installation Server specifics

The migration of the Installation Server is not performed as part of the Cell Manager migration. If Installation Server is installed on your old Cell Manager, it will not be migrated to the new Cell Manager.

If you want to use the new Cell Manager also as an Installation Server, install the Installation Server component on the new Cell Manager after the migration and import it to the cell. See the online Help index: “[Installation Server](#)”.

Upgrading the Cell Manager configured on MC/ServiceGuard

During an upgrade procedure, only the database is upgraded, and the old version of the product is removed. Data Protector A.06.10 is installed with the default selection of agents, and other agents are removed. In order to obtain a configuration equivalent to the state before the upgrade, you must manually select any other agents during the upgrade procedure or reinstall them afterwards on each physical node.

The upgrade procedure from Data Protector A.05.10, Data Protector A.05.50, or Data Protector A.06.00 consists of upgrading the primary and secondary nodes. Follow the steps described below:

Primary node

Log on to the primary node and perform the following steps:

1. Stop the old OmniBack/Data Protector package by running the `cmhaltpkg pkg_name` command (where `pkg_name` is the name of the cluster package). For example:

```
cmhaltpkg ob2cl
```

2. Activate the volume group in exclusive mode:

```
vgchange -a e -q y vg_name
```

For example:

```
vgchange -a e -q y /dev/vg_ob2cm
```

3. Mount the logical volume to the shared disk:

```
mount lv_path shared_disk
```

The `lv_path` parameter is the path name of the logical volume, and `shared_disk` is the mount point or a shared directory. For example:

```
mount /dev/vg_ob2cm/lv_ob2cm /omni_shared
```

4. Upgrade the Cell Manager following the procedure described in the sections below. Note that some of the steps are different depending on the product version you are upgrading from to Data Protector A.06.10. See [“Upgrading the UNIX Cell Manager and Installation Server”](#) on page 253.
5. Stop the Data Protector services if they are running:

```
/opt/omni/sbin/omnisv -stop
```

6. Unmount the shared disk:

```
umount shared_disk
```

For example:

```
umount /omni_shared
```

7. Deactivate the volume group:

```
vgchange -a n vg_name
```

For example:

```
vgchange -a n /dev/vg_ob2cm
```

Secondary node

Log on to the secondary node and perform the following steps:

1. Activate the volume group in exclusive mode:

```
vgchange -a e -q y vg_name
```

2. Mount the logical volume to the shared disk:

```
mount lv_path shared_disk
```

3. Upgrade the Cell Manager. The steps are different depending on the product version you are upgrading from to Data Protector A.06.10. Follow the steps described in [“Upgrading the UNIX Cell Manager and Installation Server”](#) on page 253.

4. Rename the `csfailover.sh` and `mafailover.ksh` startup scripts in the `/etc/opt/omni/server/sg` directory (for example, to `csfailover_DP51.sh` and `mafailover_DP51.ksh`) and copy the new `csfailover.sh` and the `mafailover.ksh` scripts from the `/opt/omni/newconfig/etc/opt/omni/server/sg` directory to the `/etc/opt/omni/server/sg` directory.

If you customized your old startup scripts, reimplement the changes also in the new startup scripts.

 **NOTE:**

The default paths of some configuration, log and (on UNIX) database files has been changed in Data Protector A.06.10. Some of the files are now split in the server and client directory. Refer to [“Configuration files on UNIX”](#) on page 444.

5. Stop the Data Protector services if they are running:

```
/opt/omni/sbin/omnisv -stop
```

6. Unmount the shared disk:

```
umount shared_disk
```

7. Deactivate the volume group:

```
vgchange -a n vg_name
```

Primary node

Log on to the primary node again and perform the following steps:

1. Restart the Data Protector package:

```
cmrunpkg pkg_name
```

Make sure that the package switching and switching for nodes options are enabled.

2. Configure the Cell Manager. Make sure not to be positioned in the `/etc/opt/omni` or `/var/opt/omni` directory or their subdirectories when running the script. Make also sure to have no mounted subdirectories in the `/etc/opt/omni` or `/var/opt/omni`. Run:

```
/opt/omni/sbin/install/omniforsg.ksh -primary -upgrade
```

3. Stop the Data Protector services if they are running:

```
/opt/omni/sbin/omnisv -stop
```

4. Unmount the shared disk:

```
umount shared_disk
```

5. Deactivate the volume group:

```
vgchange -a n vg_name
```

Secondary node

Log on to the secondary node again and perform the following steps:

1. Restart the Data Protector package:

```
cmrunpkg pkg_name
```

Make sure that the package switching and switching for nodes options are enabled.

2. Configure the Cell Manager. Make sure not to be positioned in the `/etc/opt/omni` or `/var/opt/omni` directory or their subdirectories when running the script. Make also sure to have no mounted subdirectories in the `/etc/opt/omni` or `/var/opt/omni`. Run:

```
/opt/omni/sbin/install/omniforsg.ksh -secondary /share  
-upgrade
```

3. Stop the Data Protector services if they are running:

```
/opt/omni/sbin/omnisv -stop
```

4. Unmount the shared disk:

```
umount shared_disk
```

5. Deactivate the volume group:

```
vgchange -a n vg_name
```

Primary node

Log on to the primary node again and perform the following steps:

1. Restart the Data Protector package:

```
cmrunpkg pkg_name
```

Make sure that the package switching and switching for nodes options are enabled.

2. Re-import the virtual host:

```
omnicc -import_host virtual_hostname -virtual
```

3. Change the Cell Manager name in the IDB:

```
omnidbutil -change_cell_name
```

4. If you have the Installation Server in the same package as the Cell Manager, import the Installation Server virtual hostname:

```
omnicc -import_is virtual_hostname
```

 **NOTE:**

All requests coming from the Cell Managers are logged in the `/var/opt/omni/log/inet.log` file on clients. To prevent unnecessary log entries, secure the clients. Refer to “[Security considerations](#)” on page 216 for information on how to secure a cell.

Upgrading the Cell Manager configured on Microsoft Cluster Server

The upgrade of Data Protector A.05.10, A.05.50 or A.06.00 Cell Manager to Data Protector A.06.10 on Microsoft Cluster Server (MSCS) is performed locally, from the Windows installation DVD-ROM.

 **NOTE:**

It is recommended that all cluster nodes have MSI 2.0 installed.

To perform the upgrade, proceed as follows:

1. Insert the Windows installation DVD-ROM and run `\Windows_other\i386\setup.exe`. It is recommended to start the setup on the currently active virtual server node.

Setup automatically detects the old version of the product and prompts you to upgrade it to Data Protector A.06.10.

Click **Next** to continue.

2. Data Protector automatically selects the components that were installed.

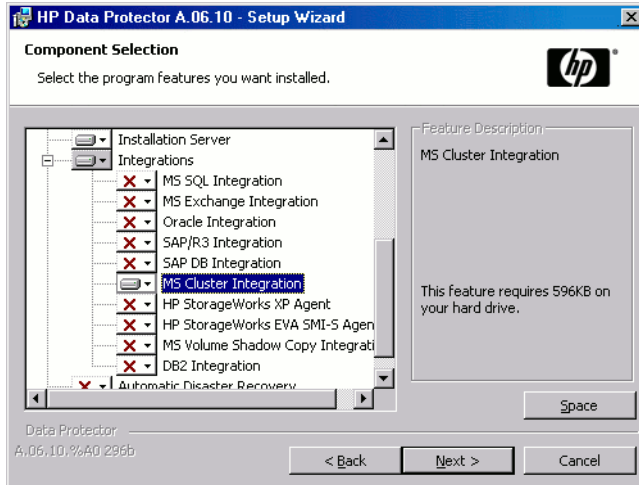

Figure 45 Selecting the components

3. The component selection summary list is displayed. Click **Install** to perform the upgrade.

Note that after the upgrade, every node has the same component set.

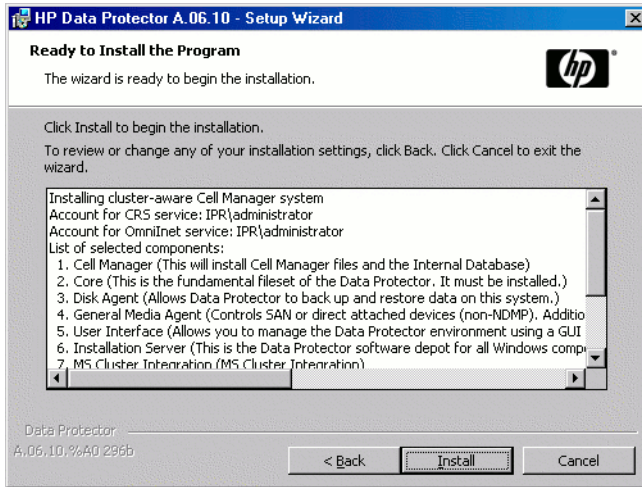

Figure 46 Component selection summary page

4. The **Installation status** page is displayed. Click **Next**.

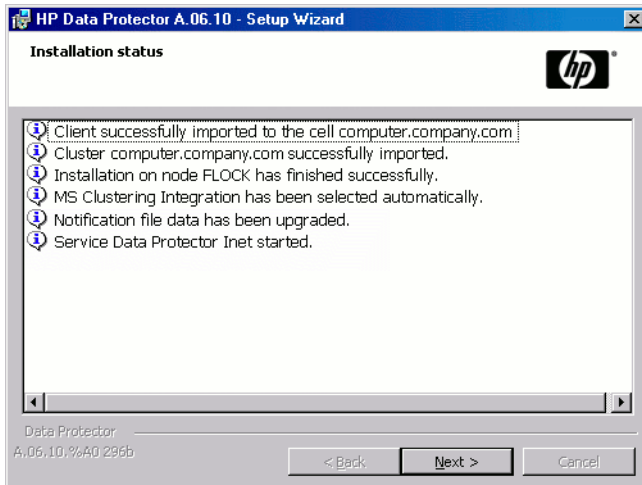

Figure 47 Installation status page

5. If you have UNIX clients in the cell, the IDB Conversion page will be displayed. Refer to "[Conversion of file names in the IDB](#)" on page 279.

6. To start using Data Protector immediately after setup, select **Start the Data Protector Manager GUI**.

To view the *HP Data Protector product announcements, software notes, and references*, select **Open the Product Announcements**.

It is *not* recommended to install the HP AutoPass utility on Microsoft Cluster Server, because it will be installed only on one node and not on all nodes. However, if you install AutoPass, you must uninstall Data Protector from the same node on which it was installed, when you decide to remove Data Protector from the system.

Click **Finish**.

 **NOTE:**

If you are upgrading cluster-aware clients, first upgrade every cluster node separately, and then re-import the virtual server. The remote upgrade is not supported.

5 Data Protector licensing

In this chapter

This chapter contains information about how Data Protector licenses are checked and reported, and about how to obtain and install Data Protector passwords.

Introduction

The Data Protector A.06.10 product structure and licensing consists of three main categories:

1. Starter Packs
2. Drive Extensions and Library Extensions
3. Functional Extensions



NOTE:

The UNIX product licenses operate on all platforms, providing the functionality regardless of the platform, while the Windows product licenses operate on the Windows, Linux, and NetWare platforms only.

Passwords are bound to the Cell Manager and are valid for the entire Data Protector cell. Clients do not require any license for filesystem or disk image backups.

License checking and reporting

Data Protector licenses are checked and if missing, reported during various Data Protector operations, for example:

- As a part of the Data Protector checking and maintenance mechanism, the licenses are checked and, if missing, reported in the Data Protector Event Log. Data

Protector Event Log is located on the Cell Manager in *Data_Protector_home\log\server\Ob2EventLog.txt*. For more information on Data Protector checking and maintenance mechanism, see the online Help index: "Event Log, Data Protector".

- When the Data Protector User Interface is started, if there are any missing licenses reported in the Data Protector Event Log, an Event Log notification is displayed. For more information on Data Protector Event Log, see the online Help index: "Event Log, Data Protector".
- When a Data Protector session is started, the licenses are checked and, if missing, reported.

Data Protector licenses are with regard to their characteristics grouped as follows:

- Cell Manager related licenses
- entity based licenses
- capacity based licenses

Cell Manager related licenses

The Data Protector Cell Manager related licenses are:

- Starter packs
- Manager-of-Managers Extension
- Single Server Edition

When a certain Data Protector component, such as the Cell Manager (included in the Starter Pack) or the Manager-of-Managers is present in the cell, only the presence of the required basic or special license is checked.

Entity based licenses

The Data Protector entity based license are:

- Library extension for one library with 61-250 slots and for one library with unlimited slots.
- Drive extension for SAN / UNIX / NAS and Drive extension for Windows / NetWare / Linux (Intel)
- On-line extension for one UNIX system and On-line extension for one Windows / Linux system

When any of the items that are the subject of the source based licenses is configured in the cell, the presence and number of the required entity based licenses is checked.

Data Protector checks the number of configured entity based items against the number of entity based licenses. If there are less licenses than configured items, Data Protector issues a notification.

With the first two licenses from the above list the following applies:

When a backup device is configured in a SAN environment for several Data Protector clients, multipath functionality must be used for Data Protector to recognize it as a single backup device.

Capacity based licenses

The Data Protector capacity based licenses are:

- Zero Downtime Backup (ZDB) for HP StorageWorks XP for 1 TB and 10 TB
- Zero Downtime Backup for HP StorageWorks Enterprise Virtual Array for 1 TB and 10 TB
- Zero Downtime Backup for EMC Symmetrix DMX 1 TB and for 10 TB
- Instant Recovery for HP StorageWorks Enterprise Virtual Array for 1TB and 10 TB
- Direct Backup for HP StorageWorks disk array XP for 1 TB and 10TB
- Direct Backup for HP StorageWorks Enterprise Virtual Array for 1TB and for 10 TB
- Direct Backup using NDMP for 1 TB and for 10 TB
- Advanced backup to disk for 1 TB, for 10 TB, and for 100 TB

The advanced backup to disk capacity based license is treated differently than other licenses in this group. See [“The advanced backup to disk license”](#) on page 313.

When a capacity based license (other than the advanced backup to disk license) is being checked, the amount of *total* disk space on logical units that have been backed up is compared to the capacity of licenses installed.

License checking is done in such a way as not to prevent you from performing instant recovery or a backup even if you have run out of licensed capacity. In these circumstances a warning message appears during the backup session informing you that you have exceeded your licensed capacity.

Capacity of used disks is calculated based on historical information gathered during each ZDB or direct backup session. The time interval taken into account is twenty-four hours. Data Protector calculates used disk capacity based on the disks that were used in all sessions in the last twenty-four hours and compares the calculated capacity with the licensed capacity.

If a license violation occurs, a warning message is issued during the backup. In addition, the license reporting tool is run daily and writes a notification to the Data Protector Event Log if the licensed capacity is exceeded.

Used capacity calculation

The used capacity calculation calculates the licensed capacity of each disk array type used in the past twenty-four hours. Disks used two or more times in the specified time interval are only counted once. Disk array units are identified by their identification numbers taken from each array. The use of array identification numbers means that it is possible to know when an array has already been counted.

If a ZDB backup has been run that includes instant recovery or direct backup, the original unit's total capacity is calculated both for ZDB used capacity per disk array, and in addition, that used for instant recovery or direct backup capacity per disk array.

For example, imagine a scenario where there are two EVA disk arrays. On one array there is a single disk (App. 1) with a capacity of 200 GB being used for data protection. An instant recovery option is included with each backup session which are triggered three times a day. Three snapshots at a time are kept, these are rotated for instant recovery purposes. On the second disk array there are two disks (App. 2 and App. 3) with capacities of 150 GB and 120GB respectively. Backup is run once a day on App.2 disk and the snapshot is deleted after the data is moved to tape. On App. 3, backup is run three times a day and five different snapshots are rotated for instant recovery. See [Figure 48](#) on page 313.

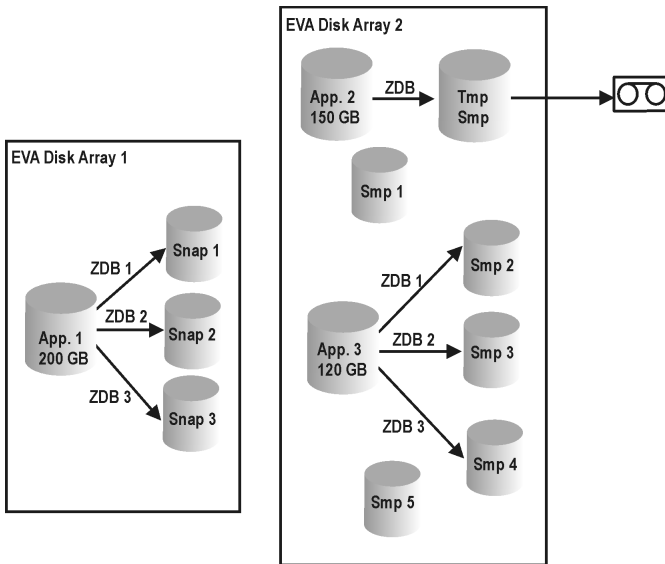

Figure 48 Used capacity calculation scenario

The calculation for ZDB used capacity counts all disks used in backup sessions in the last twenty-four hours $200\text{ GB (App.1)} + 150\text{ GB (App.2)} + 120\text{ GB (App.3)} = 470\text{ GB}$.

Calculations for instant recovery used capacity count source capacity for ZDB sessions that left data for instant recovery purposes. The same disk is only counted once $200\text{ GB (App.1)} + 120\text{ GB (App.3)} = 320\text{ GB}$.

The advanced backup to disk license

The advanced backup to disk license is required to back up to a Data Protector file library. Optionally, it can be used for a Virtual Tape Library instead of drive and library licenses. This license is required once per terabyte (TB) usable native capacity of backup disk storage.



TIP:

Additional 10 TB and 100 TB licenses are also available, which are more cost efficient than $10 \times 1\text{ TB}$ or $100 \times 1\text{ TB}$ licenses.

Usable native capacity of a Data Protector file library is the physical size on disk of the directories containing the file libraries, as reported by the file system. Usable

native capacity of a virtual tape library (VTL) is the physical size on disk of the virtual tape library consumed by all protected Data Protector backups. If Data Protector is using the VTL exclusively, it is recommended to license a quantity matching the physical capacity of the VTL. HP calls the physical VTL capacity “usable native capacity” (other vendors call it “raw capacity”)

Due to this physical size licensing concept, compression rates and deduplication rates do not need to be considered.

Note that VTL replication does not require additional licenses. No drive and library licenses are required for the tape library controlled by the HP VLS 6000/9000.

- The physical library connected to the VLS is not accessible by Data Protector directly and not licensed within Data Protector.
- The virtual media is subject to TB based licensing unless it is removed from the VLS.
- The physical media is not licensed within Data Protector.

Usable capacity differs from raw capacity in that RAID overhead is excluded. This means the RAID configuration does not need to be considered.

The backup disk storage can be distributed over multiple disk arrays and systems.

Drive and library licenses are required for file devices, but not for advanced backup to disk. In the same way, advanced backup to disk cannot be licensed with drive and library licenses.

It does not matter whether UNIX or Windows powers the backup disk.

Usable native capacity for the Data Protector file library on any disk does not charge extra for compression. Compression can be provided by the underlying operating system or by NAS (Network Attached Storage) via NFS (Network File System) or CIFS (Common Internet File System). Single instancing or deduplication of a NAS appliance falls into this category too. For Data Protector A.05.50, a patch is required for usable native capacity licensing of the Data Protector file library with no extra charge of single instancing and compression of 3rd party providers. For Data Protector A.06.00, a patch is required for VTL “usable native capacity” based licensing.

In case of central licensing with MoM, at minimum 1 TB needs to be assigned to each cell using the advanced backup to disk functionality.

Data Protector synthetic full and virtual full backup: Virtual full backups and the incremental backups to be consolidated into a synthetic/virtual full backup must be stored in the Data Protector file library, which requires this license.

Examples:

- One backup disk array with a total usable native capacity of 2.5 TB, fully used for advanced backup to disk, requires 3 x B7038AA.

- One backup disk array with a total raw capacity of 2.5 TB, fully configured in RAID 1 (mirroring) has only a usable native capacity of 1.25 TB and would only require 2 x B7038AA, if fully used for advanced backup to disk.
- Two backup disk arrays with a total usable native capacity of 2.5 TB each, fully used for advanced backup to disk, require 5 x B7038AA.
- 10 blade servers with 0.75 TB usable native capacity each, fully used for advanced backup to disk, require 8 x B7038AA.

 **NOTE:**

- Data Protector is not able to report the required amount of licenses due to the missing instrumentation and interfaces of today's Virtual Tape Libraries and some files servers hosting the Data Protector file library.
 - By default, Data Protector treats virtual tape library devices as ordinary libraries (such as SCSI II libraries). To utilize the advanced backup to disk licenses, the device must be marked as a virtual tape library during the device configuration. See the online Help index: "virtual tape library".
-

Capacity based licensing examples

This section provides examples of how capacity based licensing is calculated.

Example 1

[Figure 49](#) and shows a situation where data from one 800 GB logical unit is backed up three times a day in a ZDB-to-disk session.

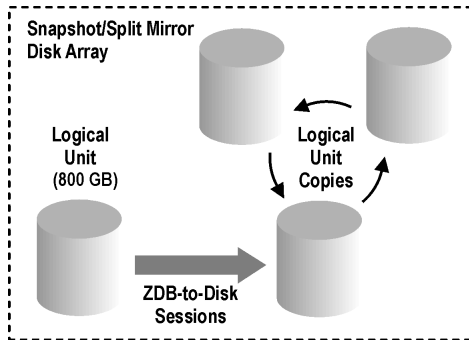

Figure 49 ZDB-to-Disk sessions

Three split mirror or snapshot copies (replicas) are rotated and kept for the purpose of instant recovery. The capacity based licensing is calculated as follows:

One 800 GB logical unit is used for ZDB-to-disk sessions:

$1 \times 800 \text{ GB} = 0.8 \text{ TB}$ for the “Zero Downtime Backup for 1 TB” license.

Three replicas of the same 800 GB logical unit are kept for the purpose of instant recovery. Note that it is the capacity of source volumes and not the capacity of replica that is the subject of the license:

$1 \times 800 \text{ GB} = 0.8 \text{ TB}$ for the “Instant Recovery for 1 TB” license.

One “Zero Downtime Backup for 1 TB” license and one “Instant Recovery for 1 TB” license are sufficient for this situation.

Example 2

Figure 50 on page 317 shows a situation where data from one 800 GB logical unit is backed up twice a day in a ZDB-to-tape session. Split mirror or snapshot copies (replicas) are, therefore, not kept for instant recovery. The capacity based licensing is calculated as follows:

One 800 GB logical unit is used for ZDB-to-disk sessions:

$1 \times 800 \text{ GB} = 0.8 \text{ TB}$ for the “Zero Downtime Backup for 1 TB license.

One “Zero Downtime Backup for 1 TB” license is sufficient.

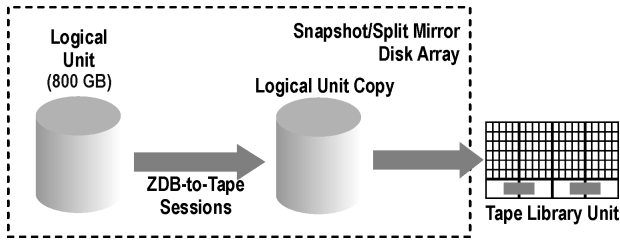

Figure 50 ZDB-to-Tape sessions

Example 3

Figure 51 on page 318 shows a situation where data from one 800 GB logical unit is backed up three times a day in a ZDB-to-disk+tape session. Five split mirror or snapshot copies (replicas) are rotated and kept for the purpose of instant recovery. The capacity based licensing is calculated as follows:

One 800 GB logical unit is used for ZDB-to-disk+tape sessions:

$1 \times 800 \text{ GB} = 0.8 \text{ TB}$ for the “Zero Downtime Backup for 1 TB” license.

Five replicas of the same 800 GB logical unit are kept for the purpose of instant recovery. Note that it is the capacity of source volumes and not the capacity of replica that is the subject of the license:

$1 \times 800 \text{ GB} = 0.8 \text{ TB}$ for the “Instant Recovery for 1 TB” license.

One “Zero Downtime Backup for 1 TB” license and one “Instant Recovery for 1 TB” license are sufficient.

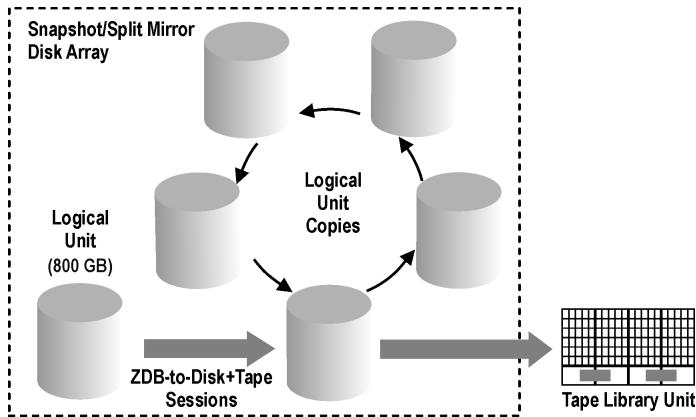

Figure 51 ZDB-to-Disk+Tape sessions

Example 4

Figure 52 on page 319 shows a situation where data from one 800 GB logical unit is backed up 4 times a day in a direct backup session. Three split mirror or snapshot copies (replicas) created during the direct backup session are rotated and kept for the purpose of instant recovery. The capacity based licensing is calculated as follows:

One 800 GB logical unit is used for direct backup sessions:

$$1 \times 800 \text{ GB} = 0.8 \text{ TB for the "Direct Backup for 1 TB" license.}$$

The same 800 GB logical unit is used for ZDB-to-disk+tape sessions and is therefore subject of another license:

$$1 \times 800 \text{ GB} = 0.8 \text{ TB for the "Zero Downtime Backup for 1 TB" license.}$$

Three replicas of the same 800 GB logical unit are kept for the purpose of instant recovery. Note that it is the capacity of source volumes and not the capacity of replica that is the subject of the license:

$$1 \times 800 \text{ GB} = 0.8 \text{ TB for the "Instant Recovery for 1 TB" license.}$$

One "Direct Backup for 1 TB" license, one "Zero Downtime Backup for 1 TB" license and one "Instant Recovery for 1 TB" license are sufficient for the situation shown in Figure 52 on page 319.

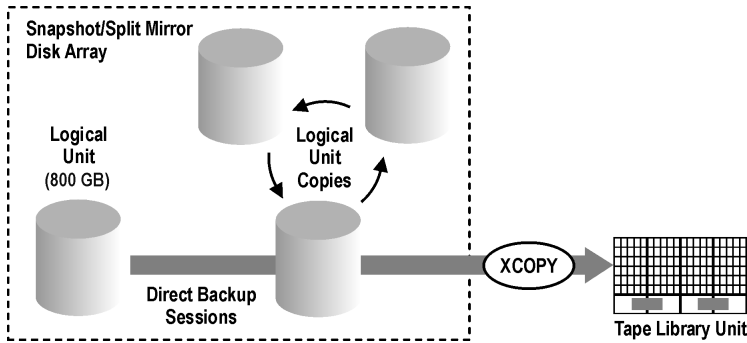

Figure 52 Direct backup sessions

Example 5

One 200 GB logical unit, one 500 GB logical unit, one 120 GB logical unit, and one 300 GB logical unit are used in ZDB sessions:

$1 \times 200 \text{ GB} + 1 \times 500 \text{ GB} + 1 \times 120 \text{ GB} + 1 \times 300 \text{ GB} = 1.12 \text{ TB}$ for the “Zero Downtime Backup for 1 TB” license.

Split mirror or snapshot copies of one 200 GB logical unit, one 120 GB logical unit, and one 300 GB logical unit are kept for the purpose of instant recovery:

$1 \times 200 \text{ GB} + 1 \times 120 \text{ GB} + 1 \times 300 \text{ GB} = 0.62 \text{ TB}$ for the “Instant Recovery for 1 TB” license.

One 300 GB logical unit is used in direct backup sessions:

$1 \times 300 \text{ GB} = 0.3 \text{ TB}$ for the “Zero Downtime Backup for 1 TB” license.

One “Direct Backup for 1 TB” license, two “Zero Downtime Backup for 1 TB” licenses and one “Instant Recovery for 1 TB” license are sufficient if all four examples in figures [Figure 49](#) on page 316 to [Figure 53](#) on page 321 are configured in a cell.

Producing a license report on demand

To produce a license report, the Data Protector `omnicc` command is to be used. Enter the following command:

```
omnicc -check_licenses [-detail]
```

If the `-detail` option is not specified, the command returns information on whether the Data Protector licensing is covered or not.

If the `-detail` option is specified, a detailed report is produced. The following information is returned for every license in the cell: license name, licenses installed, licenses used and licenses required.

`omnicc` man page for more information. Note that the command does not list the expiration dates for the licenses. Depending on the environment and the number of licenses installed, the report may take some time to generate. To get the information on the licenses expiration dates, enter the following command:

```
omnicc -password_info
```



IMPORTANT:

In a MoM environment with the CMMDB configured, when producing a license report for the items that are subject to libraries and drives, the `omnicc` command must be run on the Cell Manager with the CMMDB installed.

Which licenses are available?

The following table shows the licenses available in this product. For details of each product number, refer to [Appendix A](#) on page 347 of this guide.

1. Starter Packs (obligatory)		all platforms	Windows	Linux	HP-UX	Solaris
LTU & DVDs	1x Cell	B6960IA/J/F	B6961AA	B6961DA	B6951AA	B6951DA
Starter Pack printed manuals	Amer. Eng/Jap/French		B6961BA	B6961CA	B6951BA	B6951CA
LTU only	1x Cell					
DVDs set	Includes 3 DVDs	B6960MA				
2. drive & library extensions		all platforms	Windows, NetWare, Linux		SAN, UNIX, NAS	
drive LTU	1x drive	B6957BA/B6958BA B6958CA	B6963AA		B6953AA	
library LTU	1x 61-250/unlimited slots					
	1x upgr. to unlimited slots					
3. functional extensions		all platforms	Windows & Linux		UNIX	
functional extensions printed manuals	Amer/Jap	B6960EA/J				
on-line backup LTU	1x system	BB618AA / BA	B6965BA		B6955BA	
encryption LTU	1x 1/10-server					
manager-of-mgrs. LTU	1x system		B6966AA		B6956AA	
adv. backup to disk LTU	1x TB/10x TB/100x TB	B7038AA/BA/CA				
Backup to IAP LTU	1x TB	B7039AA				
open file backup LTU	1x enterp. svr.	BA155AA				
	1x 1-server/1x10-servers	BA153AA/BA				
media operations LTU	1x2,000/10,000 media	B7100AA/B7101AA				
	1x unlimited media	B7102AA				
	CD only/manuals only	B7129AA/B7128AA				
		NDMP	HP XP	HP EVA	EMC	
ZDB LTU	1x TB /10x TB		B7023CA/DA	B7025CA/DA	B6959CA/DA	
instant recovery LTU	1x TB /10x TB		B7026CA/DA	B7028AA/DA		
direct backup LTU	1x TB /10x TB	B7022BA/DA	B7027AA/DA			
single server edition			Windows	HP-UX	Solaris	
LTU & media / LTU only			B7030AA/BA	B7020AA/BA	B7020DA/CA	
migration to starter pack			B7031AA	B7021AA	B7021DA	

Figure 53 HP Data Protector product structure TBD

New product numbers in the above table are colored red.

Data Protector leverages the product numbers of previous Data Protector versions. This is why existing Data Protector licenses remain valid after the migration. Refer to “Data Protector A.06.10 product structure and licenses” on page 347 for more information about available licenses.

Password considerations

Consider the following to help determine the right number of passwords.

- Instant-On passwords can be used on any Cell Manager candidate. For all other types of passwords, however, you must determine the related platform. This includes the system that will become the central Data Protector administration system, the Cell Manager. It is important to use Instant-On passwords to fully understand your cell configuration requirements before requesting a permanent password.

- Permanent licenses can be moved to a different Cell Manager. However, you need to use the License Move Form(s) and send them to the *HP Password Delivery Center (PDC)*.
- Passwords are installed on the Cell Manager and are valid for the entire cell.
- Centralized licensing is provided within the Manager-of-Managers (MoM) functionality. You can have all the licenses installed on the MoM system if you purchase multiple licenses for several cells.
- You need one Cell Manager license for each cell.
- The licenses are regularly checked by the software when you perform a Data Protector configuration task or start a backup session.
- Instant-On passwords can be used on any system, while evaluation and permanent passwords can be used only on the Cell Manager system for which you requested the licenses.
- If the system on which the Cell Manager is installed has more than one IP address (multihomed systems, RAS-servers, clusters), you can bind the license to any of the IP addresses.

 **NOTE:**

If you intend to change the IP address of the Cell Manager, to move the Cell Manager to another system or to move licenses from one cell to another (and you do not use the MoM functionality), you must contact the *HP Password Delivery Center (PDC)* in order to update the licenses. See [“Other ways of obtaining and installing permanent passwords”](#) on page 326 for information about contacting the HP Password Delivery Center.

Data Protector passwords

Once you have installed Data Protector product, you can start using it for 60 days. After this period, you must install a permanent password on the Cell Manager to enable the software. You may load the software on the Data Protector Cell Manager, but you cannot perform configuration tasks without a permanent password, because the licenses required for particular Data Protector functionality require passwords.

The Data Protector licensing requires one of the following passwords:

- Instant-On password
An Instant-On password is built in the product when first installed. You are able to use the software for 60 days after you have installed it on any system supported

by Data Protector. Within this period you must request your permanent password from the *HP Password Delivery Center (PDC)* and then install it.

- Permanent passwords

The Data Protector product is shipped with an *Entitlement Certificate* license that entitles you to obtain a permanent password. The permanent password permits you to configure a Data Protector cell with regard to your backup policy, provided that you have bought all required licenses. Before you request a permanent password, you must determine the Cell Manager system and understand your cell configuration requirements.

- Emergency password

Emergency or fallback passwords are available in case the currently installed passwords do not match the current system configuration due to an emergency. They will allow operation on any system for a duration of 120 days.

Emergency passwords are issued by the support organization. They must be requested by and are issued only to HP personnel. Please refer to your support contact or to the HP Licensing site at: <http://webware.hp.com>.

The purpose of an emergency password is to enable the backup operation while the original system configuration gets reconstructed or until you move to a new permanent installation. In case of moving the licenses, you need to fill out the License Move Form and send it to the *HP Password Delivery Center (PDC)* or go to the web page <http://webware.hp.com> where passwords can be generated, moved, and so on.

The recommended way of obtaining passwords is by using the HP AutoPass utility, which can be installed during the Cell Manager installation process. Refer to “[Obtaining and installing permanent passwords using the HP AutoPass utility](#)” on page 323 for instructions on how to obtain passwords using the HP AutoPass utility after it has been installed during the Cell Manager installation process.

Refer to “[Other ways of obtaining and installing permanent passwords](#)” on page 326 for instructions on how to obtain and install a password by means other than HP AutoPass utility.

Obtaining and installing permanent passwords using the HP AutoPass utility

The HP AutoPass utility lets you install passwords for your HP products’ purchased licenses directly through the internet from the HP password delivery center web server. Refer to the HP AutoPass online Help for more information on the HP AutoPass utility.

Prerequisites

To obtain and install permanent passwords using the HP AutoPass utility, the following conditions must be fulfilled:

- Install the HP AutoPass utility with the Cell Manager. If you did not have this utility installed on your system before the Data Protector installation, you can install it using the `omnisetup.sh` script (UNIX systems) or during the Cell Manager installation (Windows systems). You can also install AutoPass as a standalone product.
- Install JRE 1.4.2_08 or higher on the Cell Manager.
- On MC/ServiceGuard, the HP AutoPass utility must be installed on all nodes.
- You need a permanent license entitlement certificate.
- You need the HP order number for the purchased licenses.
- You need the IP address of the Cell Manager or of the Manager-of-Managers.
- To install AutoPass on HP-UX 11.23 (Itanium), make sure the following patches are installed:
 - PHSS_36343 1.0 aC++ Runtime (IA: A.06.15, PA: A.0376)
 - PHSS_37039 1.0 Integrity Unwind Library

Limitations

For HP AutoPass, the following limitations apply:

- The HP AutoPass utility is not installed on Windows x64, Windows Vista, Windows Server 2008, and Linux operating systems. TBD
- It is *not* recommended to install HP AutoPass in Microsoft Cluster, because it will be installed only on one node and not on all nodes.
- The `omniinstlic` command operates only if JRE 1.4.2_08 or higher is installed on the Cell Manager.

For additional prerequisites and limitations, refer to the HP AutoPass online Help.

The passwords are installed on the Cell Manager and are valid for the entire cell.

Procedure

The following is the procedure to obtain and install a permanent password:

1. Gather the information required to obtain a permanent password. Refer to the HP AutoPass online Help to see what information is required.

2. Order the password online using the *HP AutoPass utility*. To start the *HP AutoPass utility*, run the following command on the Cell Manager:

 **NOTE:**

In a Manager-of-Managers (MoM) environment, the `omniinstlic` command must be run either on the MoM system (if Data Protector centralized licensing *is* used) or on the Cell Manager for which the passwords are being ordered and installed (if Data Protector centralized licensing *is not* used).

`/opt/omni/sbin/omniinstlic` (UNIX Cell Manager) or

`Data_Protector_home\bin\omniinstlic` (Windows Cell Manager)

For more information on the `omniinstlic` command refer to its man page.

3. Follow the *HP AutoPass utility* wizard and enter the required information.

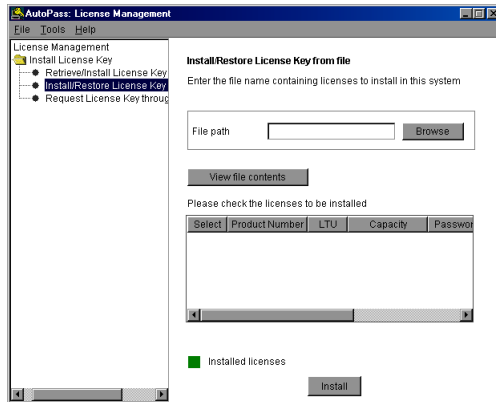

Figure 54 HP AutoPass wizard

In the last step of the wizard, clicking **Get password** will transfer permanent passwords for the purchased licenses from the *HP Password Delivery Center* to the Cell Manager.

Clicking **Finish** will install permanent passwords for the purchased licenses on the Cell Manager.

4. To verify the installed passwords, refer to “[Verifying the password](#)” on page 329 for instructions.

Standalone HP AutoPass installation

On Windows:

1. Download the up-to-date *AutoPass.msi* file from <http://autopass.india.hp.com:8080/cgi-bin/release.pl>. TBD
2. Run:

```
msiexec.exe /i FULLPATH\AutoPass.msi /qr  
INSTALLSTANDALONE=1 [AP_INSTALL_TYPE=0]  
[AP_PDF_FILE_PATH=PDFFILE]
```

On HP-UX:

1. Download the up-to-date *AutoPass.depot* file from <http://autopass.india.hp.com:8080/cgi-bin/release.pl>. TBD
2. Run the following command as root:

```
swinstall -s/Absolute_path_to_AutoPass.depot
```

On Solaris:

1. Download the up-to-date *AutoPass.pkg* file from <http://autopass.india.hp.com:8080/cgi-bin/release.pl>. TBD.
2. Run the following command as root:

```
pkgadd -d/Absolute_path_to_AutoPass.pkg
```

Other ways of obtaining and installing permanent passwords

Obtaining

The following is the procedure to obtain permanent passwords:

1. Gather the information required in the Permanent Password *Request Form*. See “[Data Protector licensing forms](#)” on page 367 to find the location of the forms and get instructions on how to fill them out.
2. See “[Data Protector A.06.10 product structure and licenses](#)” on page 347 for more information about the product structure. The *HP Password Delivery Center* will send your permanent password using the same method that you used when you sent your request. For example, if you sent your request by e-mail then you would receive your permanent password by e-mail.

3. Do one of the following:

- Go to the online *HP Password Delivery Center* site at <http://www.webware.hp.com>.
- Complete the *Permanent Password Request Form* and send it to the *HP Password Delivery Center* using one of the following (refer to the Entitlement Certificate shipped with the product for fax numbers, telephone numbers, email addresses, and hours of operation):
 - Faxing a form to the *HP Password Delivery Center*
 - Sending an e-mail to the *HP Password Delivery Center*

You can use the electronic version of the license forms that are included in the following files on the Cell Manager and the distribution media:

- On Windows Cell Manager:
`Data_Protector_home\Docs\license_forms.txt`
- On UNIX Cell Manager:
`/opt/omni/doc/C/license_forms_UNIX`
- On Windows installation DVD-ROM:
`Disk_Label:\Docs\license_forms.txt`

to “copy” and “paste” your message to the *HP Password Delivery Center (HP PDC)*.

You will receive your permanent password within 24 hours of sending your *Permanent Password Request Form*.

Installing

The following is the procedure to install a permanent password that the *HP Password Delivery Center (HP PDC)* has sent to you:

Prerequisite

You must have received permanent passwords sent from the *HP Password Delivery Center* and the Data Protector user interface must be installed on the Cell Manager. The passwords are installed on the Cell Manager and are valid for the entire cell.

Using the GUI

To install the permanent password using the Data Protector GUI, proceed as follows:

- 1.** In the Context List, click **Clients**.
- 2.** In the Scoping Pane, right-click **Data Protector Cell** and click **Add License**.

3. Type the password exactly as it appears on the *Password Certificate*.

A password consists of eight 4-character groups, separated by a space and followed by a string. Make sure that you do not have a line-feed or a return character within this sequence. The following is an example of a password:

```
4PXV EG9S B6WS 2VX3 5967 XEZX AAA9 MQJB "Product: "B6965BA
```

After you have typed in the password, check the following:

- Make sure the password appears correctly on the screen.
- Make sure there are no leading or trailing spaces, or extra characters.
- Double-check "1" (number one) characters and "l" (letter l) characters.
- Double-check "O" (uppercase letter O) characters and "0" (number zero) characters.
- Make sure that you have used the correct case. The password is case-sensitive.

Click **OK**.

The password is written to the following file:

- On Windows: *Data_Protector_home*\Config\server\Cell\lic.dat
- On UNIX: */etc/opt/omni/server/cell/lic.dat*

Using the CLI

To install the permanent password using the Data Protector CLI, proceed as follows:

- 1.** Log on to the Cell Manager.
- 2.** Run the following command:

- On Windows:

```
Data_Protector_home\bin\omnicc -install_license password
```

- On UNIX: */opt/omni/bin/omnicc -install_license password*

The *password* string must be entered exactly as it appears on the *Password Certificate*. It must be formatted as a single line and must not contain any embedded carriage returns. The password must be in quotes. If the password includes also a description in quotes, the quotes in this description must be preceded with backslashes. See the `omnicc` man page for an example and more information.

You can also append the password to the following file:

- On Windows: *Data_Protector_home*\config\server\cell\lic.dat
- On UNIX: */etc/opt/omni/server/cell/lic.dat*

If the file does not exist, create it with an editor, such as `vi` or Notepad. Refer to [Step 3](#) on page 328 in the procedure for the graphical user interface for an example of a password.

Verifying the password

Using the GUI

To verify if the password for the license you have installed is correct, proceed as follows in the Data Protector GUI:

1. In the Help menu, click **About**.
2. Click the **License** tab. All installed licenses are displayed. If the password you entered is not correct, it is listed with the remark `Password could not be decoded`.

Using the CLI

To verify if the password for the license you have installed is correct, use the following command:

- On Windows:

```
Data_Protector_home\bin\omnicc -password_info
```
- On UNIX:

```
/opt/omni/bin/omnicc -password_info
```

This command displays all installed licenses. If the password you entered is not correct, it is listed with the remark `Password could not be decoded`.

Finding the number of installed licenses

Using the GUI

Once you have installed a permanent password, you can check how many licenses are currently installed on the Cell Manager:

1. Start the Data Protector Manager.
2. In the menu bar, click **Help**, and then **About**. The About Manager window will open, displaying the installed licenses.

Using the CLI

If you use the command line, proceed as follows:

1. Log on to the Cell Manager.
2. Run the following command:
 - On Windows: `Data_Protector_home\bin\omnicc -query`
 - On UNIX: `/opt/omni/bin/omnicc -query`

A table listing the currently installed licenses will be displayed.

Moving licenses to another Cell Manager System

You must contact the *HP Password Delivery Center* in any of the following cases:

- If you wish to move the Cell Manager to another system.
- If you plan to move a license, installed on a Cell Manager not currently in use in the cell, to another Data Protector cell.

NOTE:

It is possible to move a UNIX license to another UNIX Cell Manager or to a Windows Cell Manager, but it is not possible to move a Windows license to a UNIX Cell Manager.

Use the following process to move licenses from one Cell Manager to another:

1. Fill out one *License Move Form* for each new Cell Manager and send it to the *HP Password Delivery Center*. If you want to move licenses for products, which can no longer be purchased, then please use the *License Move Forms* delivered with the previous version of the product. Refer to “[Data Protector licensing forms](#)” on page 367.

On the form, you must specify the number of licenses you want to move from the existing Cell Manager.

2. Delete the following file:
 - On Windows: `Data_Protector_home\config\server\cell\lic.dat`
 - On UNIX: `/etc/opt/omni/server/cell/lic.dat`
3. As soon as you have filled out the *License Move Form* and sent it to the *HP Password Delivery Center (PDC)*, you are legally obliged to delete all Data Protector passwords from the current Cell Manager.

4. Install the new passwords. You will receive one password for each new Cell Manager. You will also receive one new password for the current Cell Manager if licenses are left on the current Cell Manager. This new password replaces the current password entry on the current Cell Manager.

Centralized licensing

Data Protector allows you to configure centralized licensing for a whole multi-cell environment, which simplifies license management. All licenses are kept on the Manager-of-Managers (MoM) Manager system. Licenses are allocated to specific cells although they remain configured on the MoM Manager.

For more information on how to configure licenses, refer to the Data Protector online Help.

 **NOTE:**

It is possible to assign a UNIX license to another UNIX Cell Manager or to a Windows Cell Manager, but it is not possible to assign a Windows license to a UNIX Cell Manager.

The MoM functionality allows you to move (re-assign) licenses among the MoM cells. For more information, see the online Help index: “MoM environment”.

If you are installing a new Data Protector license, ensure that you check the MoM functionality before you request any licenses. If you decide to use centralized licensing at a later date, you will then have to go through the procedure of moving licenses.

 **NOTE:**

The MoM functionality allows for centralized licensing. This means you can install all licenses on the MoM Manager and then distribute them to the Cell Managers that belong to the MoM cell. You can later move (re-distribute) licenses among the MoM cells. For more information, see the online Help index: “MoM environment”.

The Data Protector order tool

Data Protector offers a simple tool, that can automatically generate a list of Data Protector product numbers needed for your environment. The Data Protector Order Tool guides you through the steps by asking simple questions about your system

configuration and intended use, displaying the structure of your cell based on the answers you provided so far.

After answering all the questions, the Order Tool will display a complete list of product numbers that need to be ordered for the environment that was described with your answers. See [Figure 55](#) on page 332 for an example.

The Order Tool is available on the Data Protector DVDs.

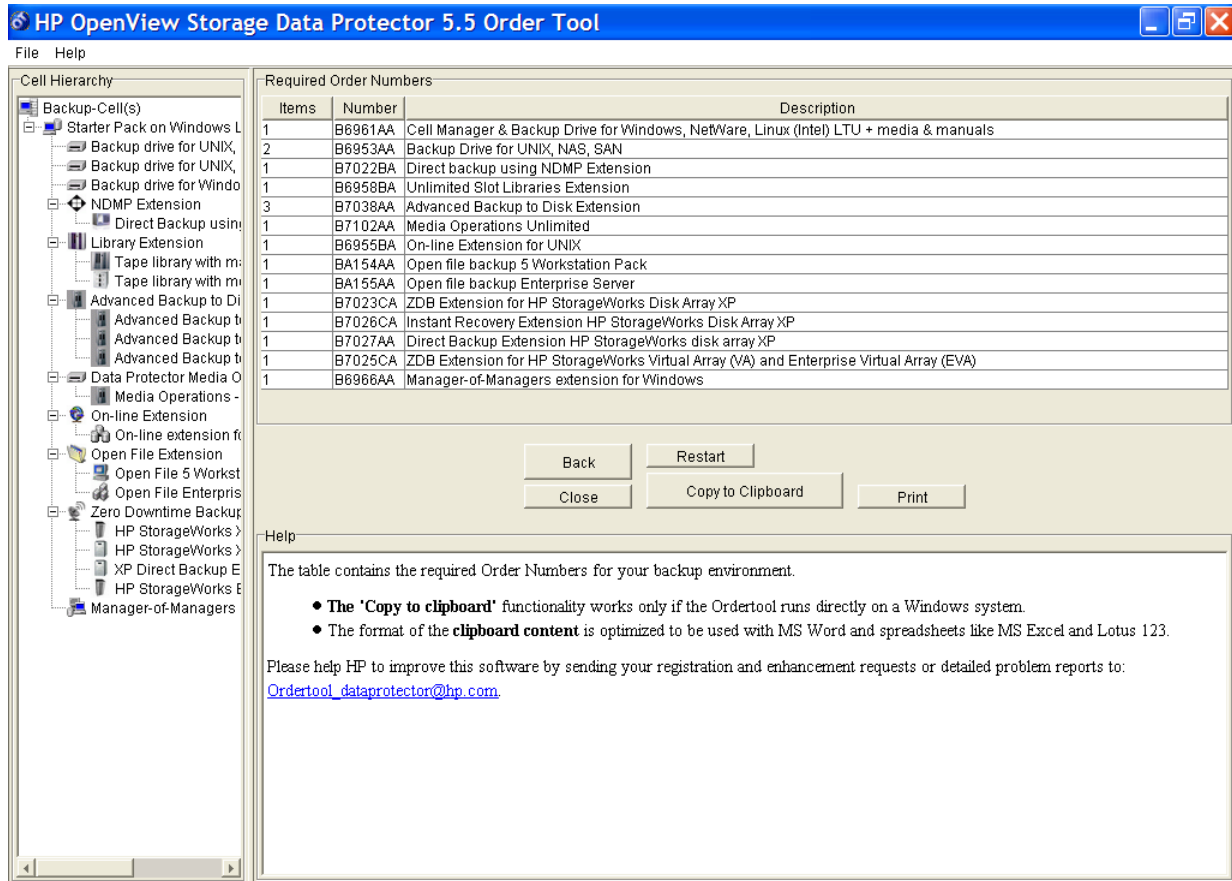

Figure 55 Data Protector order tool example TBD

6 Troubleshooting installation

In this chapter

This chapter contains information specific to installation related problems. For general troubleshooting information, see the *HP Data Protector troubleshooting guide*.

This chapter includes information on:

- “Name resolution problems when installing the Windows Cell Manager” on page 333
- “Verifying DNS connections within Data Protector cell” on page 334
- “Troubleshooting installation and upgrade of Data Protector” on page 337
- “Troubleshooting installation of the Data Protector Cell Manager on Solaris” on page 339
- “Troubleshooting installation of UNIX clients” on page 341
- “Verifying Data Protector client installation ” on page 341
- “Troubleshooting upgrade” on page 342
- “Using log files” on page 343
- “Creating installation execution traces” on page 345

Name resolution problems when installing the Windows Cell Manager

During the installation of the Data Protector Cell Manager on Windows, Data Protector detects and warns you if the DNS or the LMHOSTS file is not set up as required. In addition, Data Protector notifies you if the TCP/IP protocol is not installed on your system.

Problem

Name resolution fails when using DNS or LMHOSTS

If the name resolution fails, the “error expanding hostname” message is displayed and the installation is aborted.

- If you encounter resolution problems when using DNS, you get a warning message about your current DNS configuration.
- If you encounter resolution problems when using LMHOSTS file, you get a warning message to check your LMHOSTS file configuration.
- If you have not configured either DNS or LMHOSTS, you get a warning message to enable the DNS or the LMHOSTS resolution in the TCP/IP properties dialog.

Action

Check your DNS or LMHOSTS file configuration or activate it. See the [“Verifying DNS connections within Data Protector cell”](#) on page 334.

Problem

The TCP/IP protocol is not installed and configured on your system

Data Protector uses the TCP/IP protocol for network communications; it must be installed and configured on every client in the cell. Otherwise, the installation is aborted.

Action

Check the TCP/IP setup. For information, see [“Changing the default port number”](#) on page 399.

Verifying DNS connections within Data Protector cell

DNS (Domain Name System) is a name service for TCP/IP hosts. The DNS is configured with a list of host names and IP addresses, enabling users to specify remote systems by host names rather than by IP addresses. DNS ensures proper communication among the members of the Data Protector cell.

If DNS is not configured properly, name resolution problems may occur in the Data Protector cell and the members will not be able communicate with each other.

Data Protector provides the `omnicheck` command to verify the DNS connections among the members of the Data Protector cell. Although all possible connections in the cell can be checked with this command, it is enough to verify the following connections, which are essential in the Data Protector cell:

- Cell Manager to any other member of the cell and vice versa
- Media Agent to any other member of the cell and vice versa

Using the omnichk command

Limitations

- The command verifies connections among the cell members only; it does not verify DNS connections in general.
- It can be used only on Data Protector clients that have Data Protector A.05.10 or later installed. If the command encounters a client with an older Data Protector version, an error message is returned and the command resumes operation on the next client.

The `omnichk` command resides on the Cell Manager in the following directory:

Windows: `Data_Protector_home\bin`

UNIX: `/opt/omni/bin`

The synopsis of the `omnichk` command is:

```
omnichk -dns [-host Client | -full] [-verbose]
```

You can verify the following DNS connections in the Data Protector cell using different options:

- To check that the Cell Manager and every Media Agent in the cell resolve DNS connections to every Data Protector client in the cell properly and vice versa, run:
`omnichk -dns [-verbose]`
- To check that a particular Data Protector client resolves DNS connections to every Data Protector client in the cell properly and vice versa, run:
`omnichk -dns -host client [-verbose]`
where *client* is the name Data Protector client checked.
- To check all possible DNS connections in the cell, run:
`omnichk -dns -full [-verbose]`

When the `[-verbose]` option is specified, the command returns all the messages. If this option is not set (default), only the messages that are the result of failed checks are returned.

See the `omnichk` man page for more information.

[Table 12](#) on page 336 lists return messages for the `omnichk` command. If the return message indicates a DNS resolution problem, see the “Troubleshooting

Networking and Communication” chapter of the HP Data Protector troubleshooting guide.

Table 12 Return messages

Return Message	Meaning
<i>client_1</i> cannot connect to <i>client_2</i>	Timeout connecting to <i>client_2</i> .
<i>client_1</i> connects to <i>client_2</i> , but connected system presents itself as <i>client_3</i>	The <code>%SystemRoot%\System32\drivers\etc\hosts/etc/hosts</code> (UNIX systems) file on the <i>client_1</i> is not correctly configured or the hostname of the <i>client_2</i> does not match its DNS name.
<i>client_1</i> failed to connect to <i>client_2</i>	<i>client_2</i> is either unreachable (e.g. disconnected) or the <code>%SystemRoot%\System32\drivers\etc\hosts</code> (Windows systems) or <code>/etc/hosts</code> (UNIX systems) file on the <i>client_1</i> is not correctly configured.
checking connection between <i>client_1</i> and <i>client_2</i>	
all checks completed successfully.	
<i>number_of_failed_checks</i> checks failed.	
<i>client</i> is not a member of the cell.	
<i>client</i> contacted, but is apparently an older version. Hostname is not checked.	

Troubleshooting installation and upgrade of Data Protector

Problem

One of the following error messages is reported

- The Windows Installer Service could not be accessed.
- This application must be installed to run.
- This patch package could not be opened.
- The system cannot open the device or file specified.

After installation or upgrade to Data Protector A.06.10, Windows may report that some applications are not installed or that a reinstall is required.

The reason is an error in the Microsoft Installer upgrade procedure. Microsoft Installer version 1.x data information is not migrated to the Microsoft Installer version 2.x that Data Protector installs on the computer.

Action

On how to solve the problem, see article Q324906 in the Microsoft Knowledge Base.

Problem

Cell Manager installation on a Windows system, which is not part of any Windows domain, fails

The following error message is reported:

```
Setup is unable to match the password with the given account name.
```

Actions

Two solutions are available:

- Make the Windows system, on which you are installing the Cell Manager, part of a domain.
- Use the local administrator account for the CRS service.

Problem

The following error message is reported

```
msvcr71.dll file is not found
```

The MSVCR71.dll library (upper case) cannot be found, because only msvcr71.dll (lower case) is available on the network share. Since MSVCR71.dll and msvcr71.dll are not treated as the same files, setup.exe fails to find the appropriate dll.

Action

Rename the file from msvcr71.dll (lower case) to MSCVCR71.dll (upper case) or reconfigure the network share not to be case-sensitive.

Problem

Canceling of installation does not uninstall already installed components

If you cancel the Data Protector installation while some components have been already installed, Data Protector does not uninstall them. The installation finishes with an error.

Action

Manually uninstall already installed components after you cancelled the installation.

Problems with remote installation of Windows clients

Problem

Error starting setup process

When using Data Protector remote installation to update Windows clients, you get the following error:

```
Error starting setup process, err=[1326] Logon failure:  
unknown user name or bad password.
```

The problem is that the Data Protector Inet service on the remote computer is running under a user account that does not have access to the OmniBack share on the Installation Server computer. This is most probably a local user.

Action

Change the user for the Data Protector Inet service to one that can access the Data Protector share.

Troubleshooting installation of the Data Protector Cell Manager on Solaris

Problem

Unable to make temporary directory

During the installation of the Cell Manager on Solaris, a temporary directory cannot be created and the installation fails with the following error message:

```
Processing package instance OB2-CORE from
/tmp/DP_A0510_158_SUN78.pkg
pkgadd: ERROR: unable to make temporary directory
//tmp/old//installR.a0j3
```

Action

Manually create the missing temporary directory in the location provided in the error message and restart the installation procedure.

For example, if you get the above error message, create the following directory:
`//tmp/old//installR.a0j3`.

Troubleshooting installation of UNIX clients

Problem

Remote installation of UNIX clients fails

Remote installation or upgrade of a UNIX client fails with the following error message:

```
Installation/Upgrade session finished with errors.
```

When installing or upgrading UNIX clients remotely, the available disk space on a client system in the folder `/tmp` should be at least the size of the biggest package being installed. On Solaris client systems, the same amount of disk space should be available also in the `/var/tmp` folder.

Action

Check if you have enough disk space in the above mentioned directories and restart the installation or upgrade procedure.

For disk space requirements, see the *HP Data Protector product announcements, software notes, and references*.

Problem

Problems with the installation of an HP-UX client

When adding a new HP-UX client to a Data Protector cell, the following error message is displayed:

```
/tmp/omni_tmp/packet: you do not have the required permissions  
to perform this SD function.....
```

```
Access denied to root at to start agent on registered depot  
/tmp/omni_tmp/packet. No insert permission on host.
```

Action

Stop the `swagent` daemon and restart it by either killing the process and then restarting it by running the `/opt/omni/sbin/swagentd` command, or by running the `/opt/omni/sbin/swagentd -r` command.

Ensure that you have a local host, loopback entry in the hosts file (`/etc/hosts`).

Problem

Omniinet cannot be started after installing the UNIX Cell Manager

When starting the Cell Manager, the following error is displayed:

```
ERROR: Cannot start "omniinet" service, system error: [1053]  
Unknown error 1053.
```

Action

Check if the `inetd` or `xinetd` service is running:

HP-UX and Solaris: `ps -ef | grep inetd`

Linux: `ps -ef | grep xinetd`

To start the service, run:

HP-UX: `/usr/sbin/inetd`

Solaris: `/usr/sbin/inetd -s`

Linux: `rcxinetd start`

Troubleshooting installation of Windows XP clients

Problem

Remote installation of Windows clients fails

When a Windows XP system is a member of a workgroup and the Simple File Sharing security policy setting is turned on, users attempting to access this system through the network are forced to use the Guest account. During remote installation of a Data Protector client, Data Protector repeatedly asks for a valid username and password because administrator rights are required for the remote installation.

Action

Turn off Simple File Sharing: in Windows XP, open **Windows Explorer** or **My Computer**, click the **Tools** menu, click **Folder Options**, click the **View** tab, then clear the **Use simple file sharing (Recommended)** check box.

The Simple File Sharing policy is ignored:

- when the computer is a member of a domain
- when the Network access: Sharing and security model for local accounts security policy setting is set to Classic: Local users authenticate as themselves

Verifying Data Protector client installation

Verifying Data Protector client installation consists of the following:

- Checking the DNS configuration on the Cell Manager and client systems, and ensuring that the results of the `omnicheck -dns` command on the Cell Manager and client system match the specified system.
- Checking the software components installed on the client.
- Comparing the list of files required for a certain software component to be installed with the files installed on the client.
- Verifying the checksum for every read-only file required for a certain software component.

Prerequisite

An Installation Server must be available for the type of client system (UNIX, Windows) that you select.

Limitation

The verification procedure is not applicable for Novell NetWare and MPE clients.

To verify a Data Protector installation using the Data Protector GUI:

1. In the Context List, click **Clients**.
2. In the Scoping Pane, expand **Clients**, right-click the Cell Manager system, and then click **Check Installation** to start the wizard.
3. Follow the wizard to verify the installation of the systems in the cell. The Check Installation window opens, displaying the results of the installation.

See online Help for details.

If your installation has not succeeded, see [“Using log files”](#) on page 343.

On how to verify the installation on UNIX systems using the Data Protector CLI, see the `ob2install` man page.

Troubleshooting upgrade

Problem

IDB and configuration files are not available after upgrade

After upgrading the Cell Manager from a previous release version, the IDB and all configuration files are not available. This occurs if the upgrade procedure was interrupted for any reason.

Action

Restore Data Protector from the backup made before the upgrade, eliminate the reason of the interruption, and start the upgrade again.

Problem

Old Data Protector patches are not removed after upgrade

Old Data Protector patches are listed among installed programs if the `swlist` command is run after the Data Protector upgrade has finished. The patches were removed from your system during the upgrade, but they remained in the sw database.

To check which Data Protector patches are installed, see [“Verifying which Data Protector patches are installed”](#) on page 229.

Action

To remove the old patches from the sw database, run the following command:

```
swmodify -u patch.\* patch
```

For example, to remove a patch “PHSS_30143” from the sw database, run the following command:

```
swmodify -u PHSS_30143.\* PHSS_30143
```

Manual upgrade procedure

Normally, you upgrade Data Protector A.05.10, Data Protector A.05.50, or Data Protector A.06.00 on UNIX Cell Manager and Installation Server by running the `omnisetup.sh` command, which performs an automated upgrade procedure. However, you can also perform the upgrade manually. See [“Upgrading on HP-UX, Solaris, and Linux systems using native tools”](#) on page 388.

Using log files

If you run into problems installing Data Protector, you can examine any of the following log files to determine your problem:

- setup log files (Windows)
- system log files (UNIX)
- Data Protector log files

Which log files to check in case of installation problems depends on the type of the installation (local or remote) and on the operating system.

Local installation

In case of problems with local installation, check the following log files:

HP-UX Cell Manager:

- `/var/adm/sw/swinstall.log`
- `/var/adm/sw/swagent.log` (for more details)

On Solaris and Linux Cell Manager:

`/var/opt/omni/log/debug.log`

Windows clients (on the system where the setup is running):

- *Temp*\SetupLog.log
 - *Temp*\OB2DBG_*did*__setup_*HostName*_DebugNo_setup.txt (for more details)
- where:
- *did* (debugging ID) is the process ID of the first process that accepts the debugging parameters. This ID is used as an ID for the debugging session. All further processes will use this ID.
 - *HostName* is the name of the host where the trace file is created.
 - *DebugNo* is a number generated by Data Protector.
 - *TEMP*\CLUS_DBG_DebugNo.TXT (in cluster environments)

The location of the *Temp* directory is specified by the TEMP environment variable. To examine the value of this variable run the `set` command.

Remote installation

In case of problems with a remote installation, check the following log files:

UNIX Installation Server:

`/var/opt/omni/log/IS_install.log`

Windows clients (only on the remote client system):

- `SystemRoot\TEMP\OB2DBG_did_INSTALL_SERVICE_DebugNo_debug.txt`
- `SystemRoot\TEMP\CLUS_DBG_DebugNo.TXT`

where *Temp* is a directory specified in the TEMP environment variable and *SystemRoot* is a directory specified in the SystemRoot environment variable.

In case the setup log files are not created, run the remote installation with the debug option. See “[Creating installation execution traces](#)” on page 345.

Data Protector log files

The Data Protector log files listed below are located in:

Windows: `Data_Protector_home\log`

HP-UX, Solaris, and Linux: `/var/opt/omni/log` and
`/var/opt/omni/server/log`

Other UNIX: `/usr/omni/log`

Novell NetWare: `SYS:\USR\OMNI\LOG`

The following log files are important for troubleshooting installation:

<code>debug.log</code>	Contains unexpected conditions. While some can be meaningful to you, the information is mainly used by the support organization.
<code>inet.log</code>	Contains requests made to the Data Protector <code>inet</code> service. It can be useful to check the recent activity of Data Protector on clients.
<code>IS_install.log</code>	Contains a trace of remote installation and resides on the Installation Server.
<code>omnisv.log</code>	Contains information on when Data Protector services were stopped and started.
<code>upgrade.log</code>	This log is created during upgrade and contains upgrade core part (UCP) and upgrade detail part (UDP) messages.
<code>OB2_Upgrade.log</code>	This log is created during upgrade and contains traces of the upgrade process.

For more log files, see the *HP Data Protector troubleshooting guide*.

Creating installation execution traces

Run the installation with the `debug` option if this is requested by the HP Customer Support Service. For more information on debugging, including the debug options below, and preparing data to be sent to the HP Customer Support Service, see the *HP Data Protector troubleshooting guide*.

Windows:

For debugging remote installation on a Windows system, run the Data Protector GUI with the `debug` option:

```
Manager -debug 1-99 DebugPostfix
```

Once the session is finished/aborted, collect the debug output from the following locations:

- On the Installation Server system:

```
Data_Protector_home\tmp\OB2DBG_did__BM_  
Hostname_DebugNo_DebugPostfix
```

- On the remote system:

```
SystemRoot:\Temp\OB2DBG_did__INSTALL_SERVICE_Hostname_DebugNo_DebugPostfix
```

UNIX:

For debugging the installation on a UNIX system, run the Data Protector GUI with the debug option:

```
xomni -debug 1-99 DebugPostfix
```

or

```
xomniadmin -debug 1-99 Debug_postfix
```

Once the session is finished/aborted, collect the debug output from the Installation Server system's `tmp` directory.

A Appendix A

Data Protector A.06.10 product structure and licenses

This appendix explains the Data Protector product structure in detail, so that product numbers to be ordered can be easily identified.

The product structure is divided in different sections, as shown in [Figure 56](#) on page 348. When ordering a Data Protector solution, go through the sections as follows:

1. Select a Starter Pack. The appropriate product number depends on the operating system of your Cell Manager system.
2. Determine the number of configured drives in your environment and the tape libraries involved.
3. Identify what other functionality you need. The recommended functionality can range from on-line backup to instant recovery.

The required minimum is a Starter Pack license and media.

 **NOTE:**

The licenses delivered for the UNIX products can be applied to all operating systems.

1. Starter Packs (obligatory)		all platforms	Windows	Linux	HP-UX	Solaris
LTU & DVDs	1x Cell	B6960LA/J/F	B6961AA	B6961DA	B6951AA	B6951DA
Starter Pack printed manuals	Amer. Eng/Jap/French		B6961BA	B6961CA	B6951BA	B6951CA
LTU only	1x Cell					
DVDs set	Includes 3 DVDs	B6960MA				
2. drive & library extensions		all platforms	Windows, NetWare, Linux		SAN, UNIX, NAS	
drive LTU	1x drive	B6957BA/B6958BA B6958CA	B6963AA		B6953AA	
library LTU	1x 61-250/unlimited slots 1x upgr. to unlimited slots					
3. functional extensions		all platforms	Windows & Linux		UNIX	
functional extensions printed manuals	Amer/Jap	B6960EA/J	B6965BA		B6955BA	
on-line backup LTU	1x system	BB618AA / BA				
encryption LTU	1x 1/10-server	B7038AA/BA/CA B7039AA	B6966AA		B6956AA	
manager-of-mgrs. LTU	1x system					
adv. backup to disk LTU	1x TB/10x TB/100x TB	BA155AA BA153AA/BA	HP XP		HP EVA	
Backup to IAP LTU	1x TB					
open file backup LTU	1x <u>enterp. svr.</u>					
media operations LTU	1x 1-server/1x10-servers 1x2,000/10,000 media 1x unlimited media CD only/manuals only	B7100AA/B7101AA B7102AA B7129AA/B7128AA	NDMP		EMC	
ZDB LTU	1x TB /10x TB					
instant recovery LTU	1x TB /10x TB	B7022BA/DA	B7023CA/DA		B6959CA/DA	
direct backup LTU	1x TB /10x TB		B7026CA/DA B7027AA/DA		B7028AA/DA	
single server edition			Windows	HP-UX	Solaris	
LTU & media / LTU only migration to starter pack			B7030AA/BA B7031AA	B7020AA/BA B7021AA	B7020DA/CA B7021DA	

Figure 56 HP Data Protector product structure TBD

New product numbers in the above table are colored red.

Starter Packs

Table 13 on page 348 contains Data Protector A.06.10 Starter Pack license numbers.

Table 13 HP Data Protector Starter Pack license numbers

B6951AA	DVD and LTU for HP-UX
B6951BA	LTU only for HP-UX
B6951DA	DVD and LTU for Sun Solaris
B6951CA	LTU only for Sun Solaris

B6961AA	DVD and LTU for Windows
B6961BA	LTU only for Windows
B6961DA	DVD and LTU for Linux
B6961CA	LTU only for Linux
B6960MA	DVD set
B6960LA	Starter Pack manuals — printed (English)
B6960LJ	Starter Pack manuals — printed (Japanese)
B6960LF	Starter Pack manuals — printed (French)

The Starter Pack license-to-use (LTU) includes the license for:

- one Cell Manager on the specified platform
- unlimited number of Backup Agents on any platform
- one drive license (B6951xx contains 1xB6953AA, and B6961xx contains 1xB6963AA)
- built-in media management
- libraries up to 60 slots
- System Disaster Recovery options
- sophisticated reporting (in the Data Protector GUI and via the web)
- SAN support (with the Cell Manager on HP-UX, Solaris or Linux)
- service-centric management through integrations into HP OpenView

Media

Data Protector A.06.10 is delivered with two DVDs (UNIX and Windows). In case you require CDs, there is also a CD set available (B6960MB) consisting of 15 CDs. The DVD set is recommended.

Manuals

All manuals are available electronically on the DVDs, CDs, and at <http://www.hp.com/support/manuals>.

Printed manuals can be ordered with two different sets, the Starter Pack set and the Functional Extensions set. The Starter Pack manuals — printed includes the:

- *HP Data Protector concepts guide*
- *HP Data Protector installation and licensing guide*
- *HP Data Protector troubleshooting guide*
- *HP Data Protector disaster recovery guide*
- *HP Data Protector product announcements, software notes, and references*

 **NOTE:**

When ordering the DVD and LTU product numbers, you will receive a DVD case that includes DVDs, LTU, and the *HP Data Protector getting started guide*. Further printed manuals are not included. The manuals are electronically available on the DVD or at <http://www.hp.com/support/manuals> and can also be ordered separately.

Drive and library extensions

The following licenses are for one drive. You need as many licenses as there are drives in use at any point in time. This is typically the total number of configured drives to allow all drives to be used simultaneously. A backup drive can be a tape drive, a logical drive on disk (backup to disk using a file device), or Magneto Optical. The drive can be accessed and managed locally or via the network from a system with any Data Protector license. Drive licenses cannot be shared between multiple cells. For details of supported drives, see the Data Protector support matrices under specifications at <http://www.hp.com/support/manuals>.

Table 14 on page 350 and Table 16 on page 351 contain Data Protector A.06.10 Drive Extension and Library Extension license numbers, respectively.

Table 14 HP Data Protector drive extensions

B6953AA	for SAN, UNIX, and NAS
---------	------------------------

Includes the license-to-use (LTU) for one backup drive directly attached to a UNIX system, a NAS device, used in a SAN, or used for serverless backup.

Drives attached to HP MPE systems and OpenVMS systems require this license.

This LTU is also required for:

NAS systems managed via NDMP (for example, Network Appliance Filers and EMC Celerra File Servers), or NAS systems requiring a Data Protector proprietary Device Server (Media Agent), (for example, HP Storage Works NAS 8000).

NAS systems powered by Windows, NetWare or standard Linux which can run a standard Data Protector Device Server (Media Agent) only require Data Protector drive extensions for Windows, Netware, Linux (B6963AA).

It can also be used for single drives attached to Windows, NetWare, and Linux systems. However, in the case where the drive is not used in a SAN, it is cheaper to use LTU B6963AA.

Table 15 HP Data Protector drive extensions

B6963AA	for Windows, NetWare, and Linux
---------	---------------------------------

Includes the license-to-use (LTU) for one additional backup drive directly attached to a Windows, NetWare or Linux (Intel) system.

This license is valid for drives attached to NAS devices powered by Windows, NetWare or Linux, which can run a standard Data Protector Media Agent.

You need as many licenses as there are drives in use at any point in time. This is typically the total number of configured drives to enable all drives to be used simultaneously.

For details of supported drives, see the Data Protector support matrices under specifications at www.hp.com/go/dataprotector.

Table 16 HP Data Protector library extensions

B6957BA	for libraries with 61 to 250 slots
B6958BA	for libraries with unlimited slots
B6958CA	upgrade license to unlimited slots

The library extensions license-to-use (LTU) includes the license for managing tape libraries within one Data Protector cell. One license per library is required.

- StorageTek silos using ACSLS and GRAU/EMASS library systems using DAS require the license B6958BA.
- In case of library sharing between multiple cells, the Manager-of-Managers LTU is required for each cell to license the library across all cells with one license.
- This license is based on the physical slots inside the library, not logical slots.
- Libraries with the capability to create virtual partitions also require the license based on the number of physically available slots once per physical library.

Examples:

- One 120 slot library used within one cell partitioned into two 60 slots libraries requires one B6957BA.

- One 300 slot library shared between 3 cells (without Manager-of-Managers) using 100 slots each requires one B6957BA for each cell.
- One 300 slot library shared between 5 cells (without Manager-of-Managers) using 60 slots each does not require any library license.
- One 300 slot library shared between 3 cells using 100 slots each managed centrally via Manager-of-Managers with central media management and central licensing requires one B6958BA for all cells.

For details on supported libraries, see the Data Protector support matrices under specifications at <http://www.hp.com/support/manuals>.

Functional extensions

The tables in this section contain Data Protector A.06.10 Functional Extension license numbers.

Table 17 HP Data Protector on-line extension

B6955BA	for UNIX
B6965BA	for Windows or Linux

The on-line extension license-to-use (LTU) includes the license to perform on-line backup of databases and applications running on the specified platform.

- If a system runs multiple partitions, this LTU is required for each partition.
- In a cluster environment, each system participating in the cluster requires this LTU.
- In an Oracle Real Application Cluster (RAC), each cluster node with an installed Application Agent requires one on-line license.
- Each node with a configured Oracle DataGuard standby database in Data Protector requires this license.
- On-line backup licenses are required for Zero Downtime Backup (ZDB).
- The Windows 2003 filesystem snapshot feature VSS (Volume Shadow copy Service) is supported at no extra charge. However, on-line backup of databases which are not part of the operating system require this on-line backup extension. System configuration backup does not require the on-line backup extension.
- This LTU is required for Microsoft Exchange Single Mailbox backup.
- VMware Consolidated Backup (VCB) and VMware ESX Server backup require one Windows/Linux license per ESX server, VCB Proxy, and VMware Virtual Center participating in the backup and restore process. Script based VCB and ESX Server backup do not require an on-line backup license.

- This LTU is not required for HP Network Node Manager on-line backup.
- This LTU not required for HP Systems Insight Manager on-line backup.

For supported databases, see the Data Protector support matrices at <http://www.hp.com/support/manuals>.

Table 18 HP Data Protector open file backup extension

BA153AA	1 server
BA153BA	10 servers
BA154AA	5 workstations
BA155AA	1 enterprise server
BA152AA	CD

The Open File Backup Extension license-to-use (LTU) includes the license for open file backup of applications, databases, and e-mail files (for example, .pst - Microsoft Outlook files) running on specified servers that are not covered by the Data Protector Platform and integration matrixes.

The CD is included in the Data Protector Starter Pack DVD. It can also be ordered separately via BA152AA, which includes the open file backup CD.

For supported configurations, see the Data Protector support matrices under specification at <http://www.hp.com/support/manuals>.

Table 19 HP Data Protector Manager-of-Managers extension

B6956AA	for UNIX
B6966AA	for Windows or Linux

The Manager-of-Managers extension license-to-use (LTU) includes the license required for each Data Protector management server (Cell Manager) running on the specified platform to be part of a Manager-of-Managers environment.

This license is required to share tape libraries between multiple Data Protector cells. It is an ideal solution for central backup management of branch offices.

B6956AA can also be used for a Windows Cell Manager. However, ordering B6966AA is more affordable.

Table 20 HP Data Protector Media Operations extension

B7100AA	Entry level
B7101AA	Enterprise
B7102AA	Unlimited
B7128AA	Manuals
B7129AA	Media

- The Entry level includes the license-to-use (LTU) for 2000 media, one management server and unlimited clients.
- The Enterprise level includes the license-to-use (LTU) for 10000 media, one management server and unlimited clients.
- Unlimited includes the license-to-use (LTU) for unlimited media, one management server and unlimited clients.
- Media refers to the total number of tape media to be tracked in the Data Protector Media Operations internal database. The entry level and enterprise level licenses can be used in any combination to match your total number of tape media to be tracked.
- The Data Protector Media Operations CD is included in the Data Protector Starter Pack, but it can also be ordered separately via B7129AA.
- The Data Protector Media Operations manuals are included in the Data Protector Functional Extensions manuals pack, but they can be ordered separately via B7128AA.

Table 21 HP Data Protector advanced backup to disk extension

B7038AA	for 1 TB
B7038BA	for 10 TB
B7038CA	for 100 TB

The advanced backup to disk extension license-to-use (LTU) includes the license for the number of terabytes (TB) specified of usable native capacity of backup disk storage.

- The Advanced Backup to Disk license is required to back up to a Data Protector file library. Optionally, it can be used instead of drive licenses to back up to a Virtual Tape Library.
- Usable native capacity of a Data Protector file library is the physical size on disk of the directories containing the file libraries, as reported by the filesystem. Usable native capacity of a virtual tape library (VTL) is the physical size on disk of the virtual tape library consumed by all protected Data Protector backups. In case Data Protector is using the VTL exclusively, it is recommended to license a quantity matching the physical capacity of the VTL. HP calls the physical VTL capacity “usable native capacity” (other vendors call it “raw capacity”).
- Due to this physical size licensing concept compression rates and deduplication rates do not need to be considered.
- VTL replication does not require additional licenses. No drive and library licenses are required for the tape library controlled by the HP VLS 6000/9000.
 - The physical library connected to the VLS is not accessible by Data Protector directly and not licensed within Data Protector.
 - The virtual media is subject to TB based licensing unless it is removed from the VLS.
 - The physical media is not licensed within Data Protector.
- Usable capacity differs from raw capacity in that RAID overhead is excluded. This means the RAID configuration does not need to be considered.
- The backup disk storage can be distributed over multiple disk arrays and systems.
- Drive and library licenses are required for file devices, but not for advanced backup to disk. In the same way, advanced backup to disk cannot be licensed with drive and library licenses.
- It does not matter whether UNIX or Windows powers the backup disk.

 **NOTE:**

- Usable native capacity for the Data Protector file library on any disk does not charge extra for compression. Compression can be provided by the underlying operating system or by NAS (Network Attached Storage) via NFS (Network File System) or CIFS (Common Internet File System). Single instancing or deduplication of a NAS appliance falls into this category too. For Data Protector A.05.50, a patch is required for usable native capacity licensing of Data Protector file library with no extra charge of single instancing and compression of 3rd party providers. For Data Protector A.06.00, a patch is required for VTL “usable native capacity” based licensing.
 - In case of central licensing with MoM, at minimum 1 TB needs to be assigned to each cell using the advanced backup to disk functionality.
-

Data Protector synthetic full and virtual full backup: Virtual full backups and the incremental backups to be consolidated into a synthetic/virtual full backup must be stored in the Data Protector file library, which requires this license.

 **NOTE:**

- Data Protector is not able to report the required amount of licenses due to the missing instrumentation and interfaces of today's Virtual Tape Libraries and some files servers hosting the Data Protector file library.
- By default, Data Protector treats virtual tape library devices as ordinary libraries (such as SCSI II libraries). To utilize the advanced backup to disk licenses, the device must be marked as a virtual tape library during the device configuration. See the online Help index: "virtual tape library" for more information.

Examples:

- One backup disk array with a total usable native capacity of 2.5 TB, fully used for advanced backup to disk, requires 3 x B7038AA.
- One backup disk array with a total raw capacity of 2.5 TB, fully configured in RAID 1 (mirroring) has only a usable native capacity of 1.25 TB and would only require 2 x B7038AA, if fully used for advanced backup to disk.
- Two backup disk arrays with a total usable native capacity of 2.5 TB each, fully used for advanced backup to disk, require 5 x B7038AA.
- 10 blade servers with 0.75 TB usable native capacity each, fully used for advanced backup to disk, require 8 x B7038AA.

Table 22 HP Data Protector backup to HP IAP extension

B7039AA	for 1 TB
---------	----------

Includes the license-to-use (LTU) for 1 TB of archive disk storage. Required once per terabyte (TB) usable native capacity of archive disk storage.

- The "backup to HP IAP" license is required to back up to the HP Integrated Archive Platform (IAP).
- Usable native capacity is the usable space of the file system according to the underlying operating system.
- Usable capacity differs from raw capacity in that RAID overhead is excluded. This means the RAID configuration does not need to be considered.
- Does not require any drive and library LTU.

- Usable native capacity does not charge extra for compression. Compression can be provided by the underlying operating system. Single instancing falls into this category too.
- Replication to another HP IAP using the HP IAP built-in replication technology does not require any extra licenses.
- In case of central licensing with MoM, at minimum 1 TB needs to be assigned to each cell using the Backup to HP IAP functionality.

Example:

One HP IAP with a total usable native capacity of 2.5 TB, fully used for backup to HP IAP with single instancing, storing 100 TB of uncompressed data, requires 3 x B7039AA.

Table 23 HP Data Protector Zero Downtime Backup (ZDB) extension

B7023CA	for HP StorageWorks Disk Array XP, 1 TB
B7023DA	for HP StorageWorks Disk Array XP, 10 TB
B7025CA	for HP StorageWorks Enterprise Virtual Array, 1 TB
B7025DA	for HP StorageWorks Enterprise Virtual Array, 10 TB
B6959CA	for EMC Symmetrix / DMX, 1 TB
B6959DA	for EMC Symmetrix / DMX, 10 TB

The Zero Downtime Backup extension license-to-use (LTU) includes the license for the number of terabytes (TB) of used disk space capacity of the specified disk array protected by zero downtime backup (ZDB) and utilizing:

- HP Business Copy XP/EVA and/or HP Continuous Access XP/EVA or
- EMC TimeFinder and/or EMC SRDF

Used disk space capacity is the total capacity of all primary volumes on the disk array type used for Zero Downtime Backup or Instant Recovery. Primary means the original production data volumes. This amount represents the total usable capacity of these volumes matching with their configured LDEV sizes. Data Protector does not require licenses for the capacity consumed by secondary volumes, mirrors, or snapshots that are used for data protection.

- RAID overhead is excluded. This means the RAID configuration does not need to be considered.
- An on-line backup LTU (B6955BA, B6865BA) is required to run ZDB.

- ZDB via a Microsoft Windows 2003 VSS (Volume Shadow copy Service) hardware provider requires this ZDB extension LTU. For example, file system snapshot, Microsoft Exchange Server, or Microsoft SQL Server backup via an HP disk array provider.

Table 24 HP Data Protector Instant Recovery extension

B7026CA	for HP StorageWorks Disk Array XP, 1 TB
B7026DA	for HP StorageWorks Disk Array XP, 10 TB
B7028AA	for HP StorageWorks Enterprise Virtual Array, 1 TB
B7028DA	for HP StorageWorks Enterprise Virtual Array, 10 TB

The Instant Recovery extension license-to-use (LTU) includes the license for the number of terabytes (TB) specified of used disk space capacity, required for the Instant Recovery of the specified disk array type utilizing Instant Recovery. Data Protector Instant Recovery enables recovery of terabytes of data from one or multiple recovery disks in minutes, rather than recovery from tape, which could take hours.

Used disk space capacity is the total capacity of all volumes on the disk array types that are used for Zero Downtime Backup (ZDB) or Instant Recovery (IR). Primary means the original production data volumes. This amount represents the total usable capacity of these volumes corresponding with their configured LDEV sizes. Data Protector does not require licenses for the capacity consumed by secondary volumes, mirrors, or snapshots that are used for data protection.

- RAID overhead is excluded. This means the RAID configuration does not need to be considered.
- Requires a matching quantity of Data Protector ZDB LTUs which at the same time requires an on-line LTU.

Table 25 HP Data Protector direct backup extension

B7027AA	for HP StorageWorks Disk Array XP, 1 TB
B7027DA	for HP StorageWorks Disk Array XP, 10 TB

The direct backup extension license-to-use (LTU) includes the license to perform direct backup with HP StorageWorks Disk Array XP, required for the number of terabytes (TB) specified of used source disk space needed for direct (serverless) backup.

Requires a matching quantity of Data Protector ZDB LTUs, which at the same time require an on-line backup LTU.

Table 26 HP Data Protector direct backup using NDMP

B7022BA	for 1 TB
B7022DA	for 10 TB

Includes the license to perform the backup of the number of terabytes (TB) specified on one NDMP Server.

This license is required once per terabyte (TB) of used disk space for each filer backed up via NDMP (e.g., Network Appliance Filer or EMC Celerra File Server).

Used disk space capacity is the total capacity of all volumes of the filer backed up via NDMP. This amount represents the total usable capacity of these volumes matching with their configured LDEV sizes.

Table 27 HP Data Protector encryption extension

BB618AA	for 1 client
BB618BA	for 10 clients

Includes the license-to-use (LTU) and media to encrypt all data of one Data Protector client server or workstation. Required once for each Data Protector client (agent) with encryption configured.

- In cluster environments, each system in the cluster requires an LTU.

Table 28 HP Data Protector functional extensions printed manuals

B6960EA	English
B6960EJ	Japanese

Manuals are available electronically on the DVDs, CDs, and at <http://www.hp.com/support/manuals>. Printed manuals can be ordered with two different sets, the Starter Pack set and the Functional Extensions set. For a list of Starter Pack manuals, see “Manuals” on page 362.

The functional extensions manuals — printed, includes:

- *HP Data Protector integration guide for Microsoft applications: SQL Server, SharePoint Portal Server, Exchange Server, and Volume Shadow Copy Service*
- *HP Data Protector integration guide for Oracle and SAP*

- *HP Data Protector integration guide for IBM applications: Informix, DB2, and Lotus Notes/Domino*
- *HP Data Protector integration guide for Sybase, Network Node Manager, Network Data Management Protocol, and VMware*
- *HP Data Protector zero downtime backup integration guide*
- *HP Data Protector zero downtime backup concepts guide*
- *HP Data Protector zero downtime backup administrator's guide*
- *Integration Guide for HP Service Information Portal and HP Reporter*
- *HP Data Protector integration guide for HP Service Information Portal*
- *HP Data Protector integration guide for HP Operations Manager for UNIX*
- *HP Data Protector integration guide for HP Operations Manager for Windows*
- *OpenView operations for UNIX, product announcements, software notes, and references*
- *Data Protector media operations user's guide*
- *Data Protector media operations product announcements, software notes, and references*

Single Server Editions (SSE)

Table 29 on page 360 Contains Data Protector A.06.10 Single Server Edition Starter Pack license numbers.

Table 29 HP Data Protector SSE license numbers

B7020AA	SSE DVD and LTU for HP-UX
B7020BA	SSE LTU only for HP-UX
B7020DA	SSE DVD and LTU for Solaris
B7020CA	SSE LTU only for Solaris
B7030AA	SSE DVD and LTU for Windows
B7030BA	SSE LTU only for Windows
B7021AA	Migration to SSE for HP-UX
B7021DA	Migration to SSE for Solaris
B7031AA	Migration to SSE for Windows

B6960MA	DVD set
B6960LA	SSE manuals - printed (English)
B6960LJ	SSE manuals - printed (Japanese)
B6960LF	SSE manuals - printed (French)

License

The Single Server Edition license-to-use (LTU) includes the license to back up a single server on the specified platform with an unlimited number of UNIX and/or Windows workstations and one backup drive. Additionally, this edition can manage one autochanger/library with up to 10 slots.

Migration

The migration license-to-use (LTU) includes the license to migrate from the SSE or from Data Protector Express to Data Protector Starter Pack.

Migrate the Single Server Edition to the Starter Pack to obtain the following functionality:

- additional backup clients (agents) on any platform
- additional backup drives
- the ability to manage autoloaders/libraries with more than 10 slots
- system disaster recovery
- sophisticated reporting (in the Data Protector GUI and via the web)
- SAN support (with the management server for HP-UX, Solaris or Linux)
- service-centric management through integrations into OpenView

To order the migration LTU, a single server edition LTU is required.

Media

Data Protector A.06.10 will be delivered with two DVDs. In case you require CDs, there is also a CD set available (B6960MB) consisting of 15 CDs. The DVD set is recommended.

Manuals

All manuals are available electronically on the DVDs, CDs, and at <http://www.hp.com/support/manuals>.

Printed manuals can be ordered with two different sets, the Starter Pack set and the Functional Extensions set. The Starter Pack manuals — printed, includes:

- *HP Data Protector concepts guide*
- *HP Data Protector installation and licensing guide*
- *HP Data Protector troubleshooting guide*
- *HP Data Protector disaster recovery guide*
- *HP Data Protector product announcements, software notes, and references*

 **NOTE:**

The Single Server Edition for Windows can manage only Windows workstations.

For a list of Functional Extension manuals, see [Table 28](#) on page 359.

License migration to Data Protector A.06.10

Migration from previous versions of Data Protector is as follows:

Data Protector A.05.10, A.05.50, and A.06.00

Migrate directly to Data Protector A.06.10. No license migration is required or any other kind of migration. Data Protector A.05.10, A.05.50, and A.06.00 customers on support contract will receive Data Protector A.06.10 free of charge. Once you upgrade your environment to Data Protector A.06.10, the functionality you were using with A.05.10, A.05.50, or A.06.00 will be available with Data Protector A.06.10 at no additional cost. You only need to purchase new licenses if you want to acquire new functional extensions.

Graphical license overview

1 x B6961AA: Starter pack for Windows

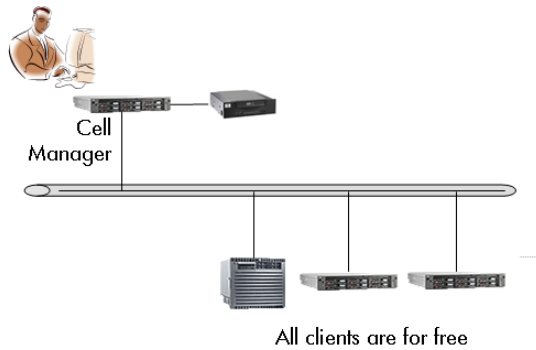

Figure 57 Starter Pack for HP-UX

1 x B6951AA: Starter pack for HP-UX
11 x B6953AA: Drive extension for UNIX, NAS, SAN
4 x B6963AA: Drive extension for Windows, NetWare, Linux (Intel)

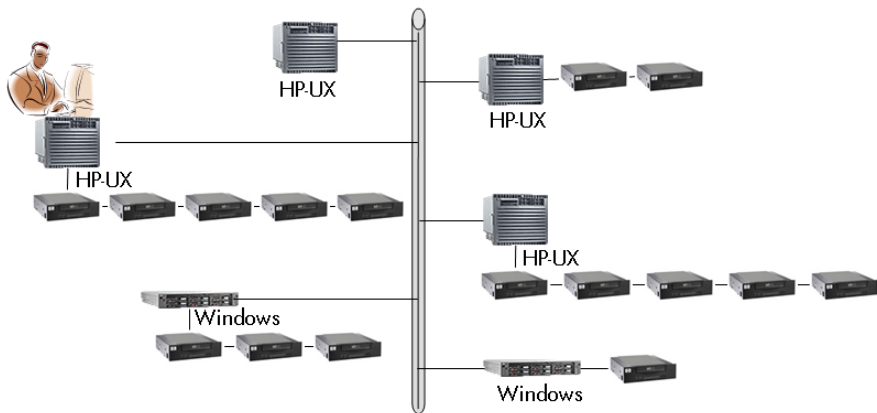

Figure 58 Mixed environment

1 x B6961AA: Starter pack for Windows
 9 x B6963AA: Drive extension for Windows, NetWare, Linux (Intel)
 4 x B6953AA: Drive extension for UNIX, NAS, SAN
 1 x B6957BA: Library extension with 61 - 250 slots
 1 x B6958BA: Library extension with unlimited slots

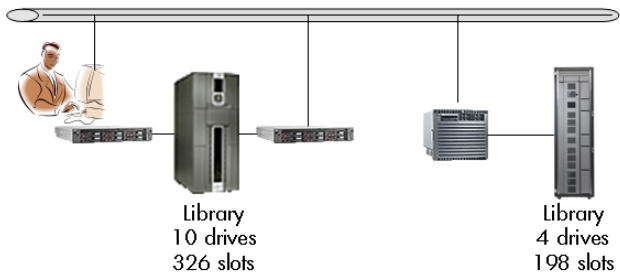

Figure 59 61 - 250 slot libraries - example 1

1 x B6951AA: Starter pack for HP-UX
 13 x B6953AA: Drive for UNIX, NAS, SAN
 1 x B6958BA: Library extension with unlimited slots
 1 x B6957BA: Library extension with 61 - 250 slots

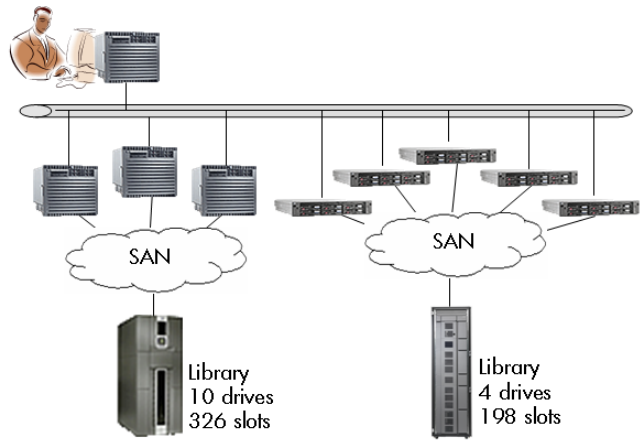

Figure 60 61 - 250 slot libraries - example 2

1 x B6951AA: Starter pack for HP-UX
 3 x B6953AA: Drive extension for UNIX, NAS, SAN
 3 x B6963AA: Drive extension for Windows, NetWare, Linux (Intel)
 4 x B6955BA: On-line extension for UNIX
 3 x B6965BA: On-line extension for Windows

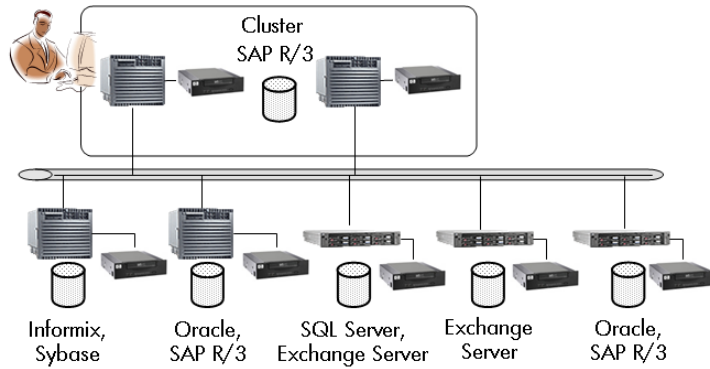

Figure 61 Online backup

3 x B6956AA: Manager-of-Managers extension for UNIX
 2 x B6966AA: Manager-of-Managers extension for Windows
 2 x B6957BA: Library extension with 61 - 250 slots

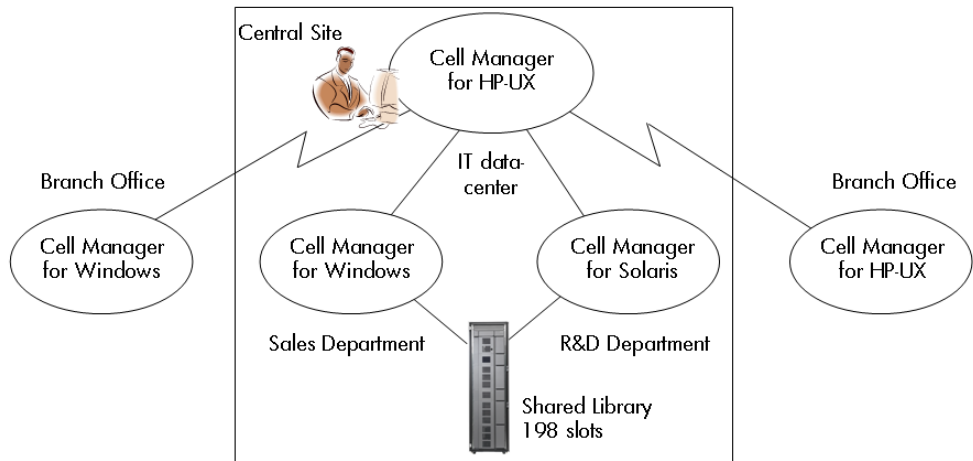

Figure 62 Manager-of-Managers

3 x B7038AA: Advanced backup to disk extension
 2 x B6951AA: Drive extension for UNIX, NAS, SAN

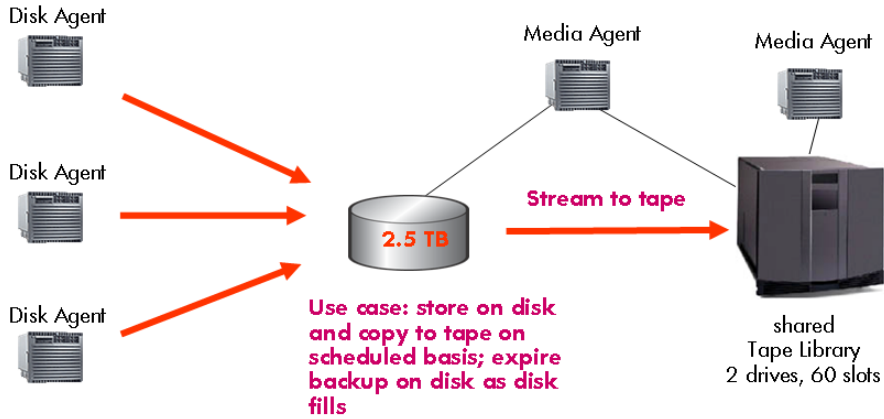
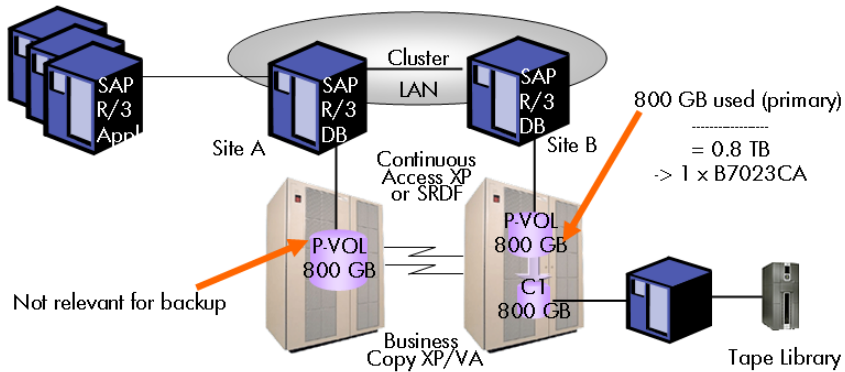

Figure 63 Advanced backup to disk

1 x B7023CA: zero downtime backup extension for HP StorageWorks XP



Note:

- zero downtime backup example - 800 GB LDEV
- RAID levels do not need to be considered (Only primary volumes need to be considered)
- Terabyte calculation also valid for instant recovery and direct backup

Figure 64 Zero downtime backup

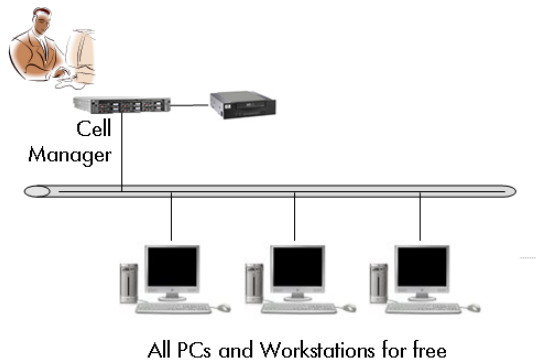

Figure 65 Single Server Edition

Data Protector licensing forms

This chapter discusses Data Protector Licensing forms. Fill them out to order permanent passwords using one of the following methods:

- Use the HP AutoPass utility to obtain and install permanent passwords directly through the internet from the HP password delivery center web server. Refer to “[Obtaining and installing permanent passwords using the HP AutoPass utility](#)” on page 323 for more information. This is the recommended method.
- Print the electronic version of the license forms that are included in the following files on the Cell Manager system and the distribution media:
 - HP-UX, Solaris, and Linux: `/opt/omni/doc/C/license_forms_UNIX`
 - Windows DVD-ROM: `Disk_Label:Docs\license_forms.txt`
 or use the electronic files to “copy” and “paste” your message to the *Password Delivery Center (PDC)*.
- Order permanent passwords using the online *Password Delivery Center* site at <http://www.webware.hp.com>.

 **IMPORTANT:**

Make sure that you type information clearly and that you do not forget the required fields.

The common fields in the licensing forms that you are required to fill out are briefly described beneath:

Personal Data	This field contains customer information, including to whom the new password should be delivered.
Licensing Data	Provide licensing information about your Data Protector cell.
Current Cell Manager	Enter the required information about your current Cell Manager.
New Cell Manager	Enter the required information about your New Cell Manager.
Order Number	Enter the <i>Order Number</i> printed on the <i>Entitlement Certificate</i> . The <i>Order Number</i> is required to verify that you are entitled to request a permanent password.
IP Address	<p>This field defines for which system the <i>Password Delivery Center</i> will generate the passwords. In case you want to use centralized licensing (MoM environments only) then this system must be the MoM Manager system.</p> <p>If the Cell Manager has the several LAN cards, you can enter any of the IP addresses. We recommend that you enter the primary one.</p> <p>If you have Data Protector in a MC/ServiceGuard or Microsoft Cluster environment, enter the IP address of your virtual server. See the online Help for more information on clusters.</p>

The *Password Delivery Center* Fax Numbers

Refer to the *Entitlement Certificate* shipped with your product for contact information.

Product License Type

In the fields next to the *Product Numbers*, enter the quantity of licenses you want to install on this Cell Manager. The quantity can be all or a subset of the licenses purchased with the *Order Number*.

B Appendix B

In this appendix

This Appendix provides some additional information about tasks that are beyond the scope of this guide but strongly influence the installation procedure.

Examples are given of system and device setup and configuration for Windows, HP-UX, Solaris, and Linux systems.

Installing on HP-UX, Solaris, and Linux systems using native tools

 **NOTE:**

The native installation procedures on HP-UX, Solaris, and Linux are only documented if you intend to install an Installation Server with a limited set of packages. It is recommended to install Data Protector using `omnisetup.sh`.

Installing a Cell Manager on HP-UX systems using `swinstall`

Follow the procedure below to install the UNIX Cell Manager on an HP-UX system:

1. Insert and mount the UNIX installation DVD-ROM and run the `/usr/sbin/swinstall` utility.

2. In the Specify Source window, select **Network Directory/CDROM**, and then enter:

- On a PA-RISC based HP-UX:

Mountpoint/hpux_pa/DP_DEPOT/DP_A0610_UX11x.sd_depot

- On a IA-64 based HP-UX:

Mountpoint/hpux_ia/DP_DEPOT/DP_A0610_UXia64.sd_depot

in the Source Depot Path. Then click **OK** to open the SD Install - Software Selection window.

3. In the list of available software packages for the installation, the Data Protector product is displayed under the name B6960MA. Double-click it to display the DATA-PROTECTOR product for UNIX. Double-click it to display the contents.

The following subproducts are included in the product:

OB2-CM Cell Manager software

OB2-DOCS Data Protector documentation subproduct that includes Data Protector manuals in PDF format and online Help (WebHelp).

OMNI-JGUI-P A Java-based graphical user interface. If you want to install the command-line interface on a client with Java GUI, you need to install the OB2-CC package.

4. Right-click **DATA-PROTECTOR**, and then click **Mark for Install** to install the whole software.

In case you do not need all subproducts, double-click **DATA-PROTECTOR** and then right-click an item from the list. Click **Unmark for Install** to exclude the package or **Mark for Install** to select it for installation.

Make sure that the *Marked?* status value next to the OB2-CM package is set to *Yes* if you are installing the Cell Manager for UNIX on the system. Refer to [Figure 66](#) on page 373.

 **NOTE:**

If you are using user IDs longer than 32 bits, you must remotely install the User Interface component (OMNI-CS) on the Cell Manager after you have installed the Core Cell Manager software component.

5. In the Actions list, click **Install (analysis)**, then click **OK** to proceed. If the **Install (analysis)** fails, displaying an error message, click **Logfile** to view the file.

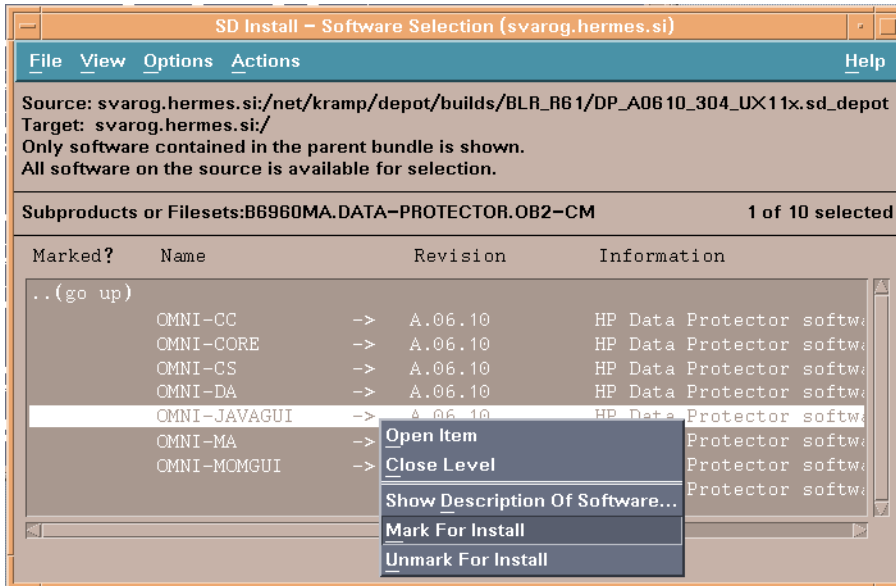

Figure 66 SD install - software selection window

 **NOTE:**

If you want to install software from a tape device across the network, you first need to mount the source directory on your computer.

Installing the Cell Manager on Solaris systems using pkgadd

Follow the procedure below to install the Cell Manager on a Solaris system:

1. Insert the UNIX installation DVD-ROM.

2. Change to the main *package_source* directory, i.e. the directory that contains the installation depot file (in this case *Mount_point/solaris/DP_DEPOT*).

The following sub-product packages related to Cell Manager installation are included in the product:

OB2-CORE	Data Protector Core software.
OB2-CC	Cell Console software. This contains the graphical user interface and the command-line interface.
OB2-CS	Cell Manager software.
OB2-DA	Disk Agent software. This is required, otherwise it is not possible to back up the IDB.

and optionally:

OB2-MA	The General Media Agent software. This is required if you want to attach a backup device to the Cell Manager.
OB2-DOCS	Data Protector documentation subproduct that includes Data Protector manuals in PDF format and online Help (WebHelp).
OB2-JGUI-P	A Java-based graphical user interface. If you want to install the command-line interface on a client with Java GUI, you need to install the OB2-CC package.

3. Use the `pkgadd` facility to install the above packages.

 **IMPORTANT:**

The sub-product packages on Solaris are dependent on each other. You should install the packages in the order in which they are listed above.

Run the following command to install each package:

```
pkgadd -d DP_A0610_SUN8.pkg package_name
```

4. Restart the Data Protector services:

```
/opt/omni/sbin/omnisv stop
```

```
/opt/omni/sbin/omnisv start
```

 **NOTE:**

If you installed the Cell Manager on Solaris 9 or Solaris 10, remotely install the Disk Agent on the Cell Manager using an Installation Server. This will replace the generic Solaris Disk Agent with the Solaris 9 or Solaris 10 Disk Agent. Refer to [“Remote installation of Data Protector clients”](#) on page 77 or to the `ob2install` man page.

Installing the Cell Manager on Linux systems using rpm

Follow the procedure below to install the Cell Manager on a Linux system:

1. Insert and mount the UNIX installation DVD-ROM.

2. Extract individual packages:

- Use `rpm2cpio` (recommended):

Change to the temporary directory where you want to extract the archives and run:

```
rpm2cpio pkg_source/ DP_A0610_GPLx86_64.rpm | cpio -ivd
```

Where `pkg_source` is the directory containing the installation archive (in this case `Mount_point/linux/DP_DEPOT`).

- Alternatively, use `rpm`:

Change to the directory containing the installation archive (in this case `Mount_point/linux/DP_DEPOT`, and run:

```
rpm -i DP_A0610_GPLx86_64.rpm
```

NOTE:

The above `rpm -i` command does not install the software. Instead, only individual rpm packages are copied to `/opt/omni`.

However, the package is still registered; therefore you need to remove the package `OB2-CM` after you finish the installation of individual packages.

3. Change to the directory where the individual packages are extracted:
- If you used `rpm2cpio`: `cd temporary_directory/opt/omni`
 - If you used `rpm`: `cd /opt/omni`

To install a package, run:

```
rpm -i package_name-A.06.10-1.x86_64.rpm
```

where `package_name` is the name of sub-product package.

The following packages must be installed:

OB2-CORE Data Protector Core software.

OB2-CC Cell Console software. This contains the command-line interface.

OB2-CS Cell Manager software.

OB2-DA Disk Agent software. This is required, otherwise it is not possible to back up the IDB.

Optionally, install:

OB2-MA The General Media Agent software. This is required if you want to attach a backup device to the Cell Manager.

OB2-DOCS Data Protector documentation subproduct that includes Data Protector manuals in PDF format and online Help (WebHelp).

OB2-JGUI-P A Java-based graphical user interface. If you want to install the command-line interface on a client with Java GUI, you need to install the OB2-CC package.

 **IMPORTANT:**

The sub-product packages on Linux are dependent on each other. You should install the packages in the order in which they are listed above.

4. Restart the Data Protector services:

```
/opt/omni/sbin/omnisv stop
```

```
/opt/omni/sbin/omnisv start
```

5. If you used `rpm` for unpacking the main rpm archive, remove the package OB2-CM:

```
rpm -e OB2-CM
```

Installing an Installation Server on HP-UX systems using `swinstall`

1. Insert and mount the UNIX installation DVD-ROM.
2. At the command line, type `/usr/sbin/swinstall` to run the installation program.
3. In the Specify Source window, select **NetworkPath/CDROM**, and then in the Source Depot Path text box, enter:

- On a PA-RISC based HP-UX:

```
Mount_point/hpux_pa/DP_DEPOT/DP_A0610_UX11x_IS.sd_depot.
```

- On a IA-64 based HP-UX:

```
Mount_point/hpux_ia/DP_DEPOT/DP_A0610_UXia64_IS.sd_depot.
```

Then open the SD Install - Software selection window.

4. In the SD Install - Software Selection window, double-click **DATA-PROTECTOR** to list the software for the installation. Right-click **OB2-IS**, and then click **Mark for Install**.
5. From the Actions menu, click **Install (analysis)**. Click **OK** to proceed.

When the installation is finished, the software depot for UNIX is located in the `/opt/omni/databases/vendor` directory.

 **IMPORTANT:**

If you do not install the Installation Server for UNIX on your network, you will have to install every UNIX client locally from the UNIX installation DVD-ROM.

Installing an Installation Server on Solaris systems using pkgadd

Local installation on Solaris

To install the Installation Server for UNIX on a Solaris system:

1. Insert the UNIX installation DVD-ROM.
2. Change to the `mainpackage_source` directory, that is the directory that contains the installation depot file (in this case `Mount_point/solaris/DP_DEPOT`).

The following sub-product packages related to Installation Server installation are included in the product:

OB2-CORE	Data Protector Core software. Note that this is already installed, if you are installing the Installation Server on the Cell Manager system.
OB2-C-IS	Installation Server Core software.
OB2-SOLUX	Disk Agent, Media Agent, and GUI push packets for remote Solaris systems.
OB2-OTHUX	Disk Agent and Media Agent push packets for remote non-Solaris UNIX systems.

Also, if you are setting up an independent Installation Server (that is, not on the Cell Manager) and want to use the user interface:

OB2-CC	Cell Console software. This contains the graphical user interface and the command-line interface.
--------	---

3. Use the `pkgadd` facility to install the above packages.

 **IMPORTANT:**

The sub-product packages on Solaris are dependent on each other. You should install the packages in the order in which they are listed above.

Run the following command to install each package:

```
pkgadd -d DP_A0610_SUN8_IS.pkg package_name
```

 **NOTE:**

The `pkgadd` facility can only be run locally, not remotely.

4. Once you have installed these components, use `pkgadd` to install the push packets for all the integration packages that you will want to install remotely. For instance:

OB2-INTGP	Data Protector Core Integrations software. This component is necessary if you want to install integrations.
OB2-ORACORE	Data Protector Core Oracle and SAP R/3 integration software. This component is necessary if you want to install the Data Protector SAP R/3 or Oracle integration.
OB2-SAPP	SAP Integration component.
OB2-SAPDBP	SAP DB Integration component.
OB2-INFP	Informix Integration component.
OB2-LOTP	Lotus Notes/Domino Integration component.
OB2-SYBP	Sybase Integration component.
OB2-OR8P	Oracle Integration component.
OB2-DB2P	DB2 Integration component.
OB2-EMCP	EMC Symmetrix Integration component.
OB2-SNAPP	HP StorageWorks Virtual Array.
OB2-SMISAP	HP StorageWorks Enterprise Virtual Array.
OB2-SSEAP	HP StorageWorks Disk Array XP.
OB2-NDMPP	The NDMP Media Agent software.
OB2-OVP	OpenView Integration component.
OB2-FRAP	French localization package.

When the installation is finished, the software depot for UNIX is located in the `/opt/omni/databases/vendor` directory.

 **IMPORTANT:**

If you do not install an Installation Server for UNIX on your network, you will have to install every UNIX client locally from the UNIX installation DVD-ROM.

 **IMPORTANT:**

If you want to install Data Protector to linked directories, for instance:

```
/opt/omni/ -> /prefix/opt/omni/  
/etc/opt/omni/ -> /prefix/etc/opt/omni/  
/var/opt/omni/ -> /prefix/var/opt/omni/
```

you must create the links before the installation and ensure that the destination directories exist.

 **NOTE:**

If you install the User Interface component (either the graphical user interface or the command-line interface), you should update your environment variables before using it. Refer to [“Setting environment variables”](#) on page 51 for more information.

If you intend to use the Data Protector user interface to perform backups or restores across platforms, refer to the HP Data Protector product announcements, software notes, and references for the limitations incurred.

What's next?

At this point, you should have the Installation Servers for UNIX installed on your network. Now you should perform the following tasks:

1. If you have set up an independent Installation Server (i.e. not on the Cell Manager) you must manually add (import) the system to the Data Protector cell. Refer to [“Importing an installation server to a cell”](#) on page 210.

 **NOTE:**

When an Installation Server is imported, the file `/etc/opt/omni/server/cell/installation_servers` on the Cell Manager is updated to list the installed push-packets. This can be used from the CLI to check the available push-packets. For this file to be kept up to date, you should export and re-import an Installation Server whenever push-packets are installed or deleted. This applies even if an Installation Server is installed on the same system as the Cell Manager.

2. Install the Installation Server for Windows in case you have any Windows systems in your Data Protector cell. Refer to [Prerequisites](#) on page 65.
3. Distribute the software to clients. Refer to [“Installing Data Protector clients”](#) on page 69.

Installing an Installation Server on Linux systems using rpm

Local installation on Linux

To install the Installation Server for UNIX on a Linux system:

1. Insert the UNIX installation DVD-ROM.

2. Extract individual packages:

- Use `rpm2cpio` (recommended):

Change to the temporary directory where you want to extract the archives and run:

```
rpm2cpio pkg_source/ DP_A0610_GPLx86_64.rpm | cpio -ivd
```

Where `pkg_source` is the directory containing the installation archive (in this case `Mount_point/linux/DP_DEPOT`).

- Alternatively, use `rpm`:

Change to the directory containing the installation archive (in this case `Mount_point/linux/DP_DEPOT`, and run:

```
rpm -i DP_A0610_GPLx86_64_IS.rpm
```

NOTE:

The above `rpm -i` command does not install the software. Instead, only individual rpm packages are copied to `/opt/omni`.

However, the package is still registered; therefore you need to remove the package `OB2-CM` after you finish the installation of individual packages.

3. Change to the directory where the individual packages are extracted:
- If you used `rpm2cpio`: `cd temporary_directory/opt/omni`
 - If you used `rpm`: `cd /opt/omni`

For each package, run:

```
rpm -i package_name-A.06.10-1.x86_64.rpm
```

The following sub-product packages (*package_name*) related to Installation Server installation are included in the product:

OB2-CORE	Data Protector Core software. Note that this is already installed, if you are installing the Installation Server on the Cell Manager system.
OB2-CORE-IS	Installation Server Core software.
OB2-LINUXP	Disk Agent, Media Agent, and GUI push packets for remote Linux systems.
OB2-OTHUXP	Disk Agent and Media Agent push packets for remote non-Linux systems.

Also, if you are setting up an independent Installation Server (that is, not on the Cell Manager) and want to use the user interface:

OB2-CC	Cell Console software. This contains the command-line interface.
OB2-DOCS	Data Protector documentation subproduct that includes Data Protector manuals in PDF format and online Help (WebHelp).
OB2-JGUI-P	A Java-based graphical user interface. If you want to install the command-line interface on a client with Java GUI, you need to install the OB2-CC package.

4. Once you have installed these components, use `rpm` to install the push packets for all the integration packages you will want to install remotely. For instance:

OB2-INTGP	Data Protector Core Integrations software. This component is necessary if you want to install integrations.
OB2-ORACORE	Data Protector Core Oracle and SAP R/3 integration software. This component is necessary if you want to install the Data Protector SAP R/3 or Oracle integration.
OB2-SAPP	SAP Integration component.
OB2-VMWARE	VMware Integration component.
OB2-SAPDBP	SAP DB Integration component.
OB2-INFP	Informix Integration component.
OB2-LOTP	Lotus Notes/Domino Integration component.
OB2-SYBP	Sybase Integration component.
OB2-OR8P	Oracle Integration component.
OB2-DB2P	DB2 Integration component.
OB2-EMCP	EMC Symmetrix Integration component.
OB2-SNAPP	HP StorageWorks Virtual Array.
OB2-SMISAP	HP StorageWorks Enterprise Virtual Array.
OB2-SSEAP	HP StorageWorks Disk Array XP.
OB2-NDMPP	The NDMP Media Agent software.
OB2-OVP	OpenView Integration component.

OB2-FRAP French localization package.

OB2-JPNP Japanese localization package.

When the installation is finished, the software depot for UNIX is located in the `/opt/omni/databases/vendor` directory.

 **IMPORTANT:**

If you do not install an Installation Server for UNIX on your network, you will have to install every UNIX client locally from the UNIX installation DVD-ROM.

- 5.** If you used `rpm` for unpacking the main rpm archive, remove the package OB2-CM:

```
rpm -e OB2-CM
```

 **IMPORTANT:**

If you want to install Data Protector to linked directories, for instance:

```
/opt/omni/ -> /prefix/opt/omni/
```

```
/etc/opt/omni/ -> /prefix/etc/opt/omni/
```

```
/var/opt/omni/ -> /prefix/var/opt/omni/
```

you must create the links before the installation and ensure that the destination directories exist.

What's next?

At this point, you should have the Installation Servers for UNIX installed on your network. Now you should perform the following tasks:

1. If you have set up an independent Installation Server (i.e. not on the Cell Manager) you must manually add (import) the system to the Data Protector cell. Refer to [“Importing an installation server to a cell”](#) on page 210.



NOTE:

When an Installation Server is imported, the file `/etc/opt/omni/server/cell/installation_servers` on the Cell Manager is updated to list the installed push-packets. This can be used from the CLI to check the available push-packets. For this file to be kept up to date, you should export and re-import an Installation Server whenever push-packets are installed or deleted. This applies even if an Installation Server is installed on the same system as the Cell Manager.

2. Install the Installation Server for Windows in case you have any Windows systems in your Data Protector cell. Refer to [Prerequisites](#) on page 65.
3. Distribute the software to clients. Refer to [“Installing Data Protector clients”](#) on page 69.

Installing the clients

The clients are not installed during a Cell Manager or Installation Server installation. The clients must be installed either by using `omnisetup.sh` or by pushing the installation components from the Data Protector GUI. For detailed information on how to install the clients, refer to [“Installing Data Protector clients”](#) on page 69.

Upgrading on HP-UX, Solaris, and Linux systems using native tools

Upgrading Data Protector on HP-UX systems using swinstall

An upgrade of a Cell Manager must be performed from UNIX installation DVD-ROM.

If you are upgrading a Cell Manager with an Installation Server installed, you must first upgrade the Cell Manager and then the Installation Server.

Client components that are installed on the Cell Manager system are *not* upgraded during a Cell Manager upgrade and must be upgraded either by using `omnisetup.sh` or by pushing the installation components from the Installation

Server. For details refer to [“Local installation of UNIX clients”](#) on page 146 or [“Remote installation of Data Protector clients”](#) on page 77.

Upgrade procedure

To upgrade Data Protector A.05.10 , A.05.50, or A.06.00 to Data Protector A.06.10, using `swinstall`, proceed as follows:

1. Log in as `root` and shut down the Data Protector services on the Cell Manager by running the `/opt/omni/sbin/omnisv -stop` command.
Type `ps -ef | grep omni` to verify whether all the services have been shut down. There must be no Data Protector services listed after executing the `ps -ef | grep omni` command.
2. To upgrade a Cell Manager or/and an Installation Server, follow the procedures described [“Installing a Cell Manager on HP-UX systems using swinstall”](#) on page 371 or/and [“Installing an Installation Server on HP-UX systems using swinstall”](#) on page 378.

The installation procedure will automatically detect the previous version and upgrade *only the selected* components. If a component that was installed in the previous version of Data Protector is not selected, it is *not* upgraded. Therefore, you must ensure that you select all components that must be upgraded.

NOTE:

The `Match what target has` option is *not* supported if you are upgrading both, the Cell Manager and Installation Server on the same system.

Upgrading Data Protector on Solaris systems using pkgadd

To upgrade the Solaris Cell Manager or Installation Server, uninstall the old version and install the new version of the product.

Client components that are installed on the Cell Manager system are *not* upgraded during a Cell Manager upgrade and must be upgraded either by using `omnisetup.sh` or by pushing the installation components from the Installation Server. For details refer to [“Local installation of UNIX clients”](#) on page 146 or [“Remote installation of Data Protector clients”](#) on page 77.

Upgrade procedure

To upgrade Data Protector A.05.10, A.05.50, or A.06.00 to Data Protector A.06.10 using `pkgadd`, proceed as follows:

1. Log in as `root` and shut down the Data Protector services on the Cell Manager by running the `/opt/omni/sbin/omnisv -stop` command.

Type `ps -ef | grep omni` to verify whether all the services have been shut down. There must be no Data Protector services listed after executing the `ps -ef | grep omni` command.

2. Uninstall Data Protector using `pkgrm`.

The configuration files and the database are preserved during this procedure.

3. Run the `pkginfo` command to verify that you uninstalled the old version of Data Protector. Old versions of Data Protector should not be listed.

Verify that the database and configuration files are still present. The following directories should still exist and contain binaries:

- `/opt/omni`
- `/var/opt/omni`
- `/etc/opt/omni`

4. If you are upgrading a Cell Manager, insert and mount the UNIX installation DVD-ROM and use `pkgadd` to install the Cell Manager. For detailed steps, refer to [“Installing the Cell Manager on Solaris systems using pkgadd”](#) on page 373.

If you are upgrading an Installation Server, insert and mount the UNIX installation DVD-ROM and install the Installation Server. For detailed steps, refer to [“Installing an Installation Server on Solaris systems using pkgadd”](#) on page 379.

NOTE:

If you upgraded the Cell Manager on Solaris 9 or Solaris 10, remotely install the Disk Agent on the Cell Manager after upgrade is complete, using an Installation Server. This will replace the generic Solaris Disk Agent with the Solaris 9 or Solaris 10 Disk Agent. Refer to [“Remote installation of Data Protector clients”](#) on page 77 or to the `ob2install` man page.

Upgrading Data Protector on Linux systems using rpm

To upgrade the Linux Cell Manager or Installation Server, uninstall the old version and install the new version of the product.

Client components that are installed on the Cell Manager system are *not* upgraded during a Cell Manager upgrade and must be upgraded either by using `omnisetup.sh` or by pushing the installation components from the Installation Server. For details refer to “[Local installation of UNIX clients](#)” on page 146 or “[Remote installation of Data Protector clients](#)” on page 77.

Upgrade procedure

To upgrade Data Protector A.05.10, A.05.50, or A.06.00 to Data Protector A.06.10 using `rpm`, proceed as follows:

1. Log in as `root` and shut down the Data Protector services on the Cell Manager by running the `/opt/omni/sbin/omnisv -stop` command.

Type `ps -ef | grep omni` to verify whether all the services have been shut down. There must be no Data Protector services listed after executing the `ps -ef | grep omni` command.

2. Uninstall Data Protector using `rpm`.

The configuration files and the database are preserved during this procedure.

3. Run the `rpm -q` command to verify that you uninstalled the old version of Data Protector. Old versions of Data Protector should not be listed.

Verify that the database and configuration files are still present. The following directories should still exist and contain binaries:

- `/opt/omni`
- `/var/opt/omni`
- `/etc/opt/omni`

4. If you are upgrading a Cell Manager, insert and mount the UNIX installation DVD-ROM and use `rpm` to install the Cell Manager. For detailed steps, refer to [Installing the Cell Manager on Linux systems using rpm](#).

If you are upgrading an Installation Server, insert and mount the UNIX installation DVD-ROM and install the Installation Server. For detailed steps, refer to [Installing an Installation Server on Linux systems using rpm](#).

Setting up the TCP/IP protocol on Windows systems

IMPORTANT:

Only the Microsoft implementation of the TCP/IP protocol is supported.

Data Protector uses the TCP/IP protocol for network communications and must be installed and configured on every client in the cell.

Entering a command using the Data Protector user interface establishes a connection to the Cell Manager through the TCP/IP protocol.

The TCP/IP protocol is a group of related protocols and utilities used for network communications. It consists of the TCP (Transmission Control Protocol) and the IP (Internet Protocol).

The TCP/IP software is installed on a hard disk, and each computer that uses this protocol must have the following addresses, usually assigned by the network administrator:

- The `IP address` for each network adapter card installed on the computer. This is a 32-bit number, usually displayed in the dotted quad or dotted decimal format.
- The `Subnet mask` for each network adapter card installed on the computer, which, combined with `IP address`, identifies the Network ID and the host ID. The `Subnet mask` is displayed in the same format as the `IP address`.
- The `Default Gateway` address is required for the default local gateway (IP router) to enable Internet access.

Prerequisites

Before installing the TCP/IP protocol on Windows computers, you need to know the following:

- There are different configuration options, depending on the type of Windows software installed on your computer.
A Windows Server computer can be configured as a Dynamic Host Configuration Protocol (DHCP) server, a Windows Internet Name Service (WINS) server, or a Domain Name System (DNS) server, among others. See the Windows online Help for details.
- You can configure the TCP/IP protocol automatically using DHCP as long as you have the DHCP server installed on your network.

The TCP/IP protocol must be configured manually if there is no DHCP server available on your network or if you configure the TCP/IP protocol on the DHCP server computer. See the Windows online Help for details.

- If you configure the TCP/IP manually, make sure that you are logged on as a member of the Administrator group for the local computer. To prevent duplicate addresses, make sure that all values are obtained from your network administrator. In addition to the IP address, Subnet mask, and Default gateway mentioned above, you need to obtain:
 - The name of your DNS domain and the IP addresses of the DNS servers, if you will be using DNS services.
 - The IP addresses for WINS servers if there are WINS servers available on your network.

Installing and configuring the TCP/IP protocol on Windows

The TCP/IP protocol on Windows systems is installed during the installation of the operating system.

To check the current TCP/IP settings on Windows 2000 system, proceed as follows:

- 1.** In the Windows Control Panel, double-click **Network** and **Dial-up Connections**, and then **Local Area Connection**.
- 2.** Click **Properties** and double-click **Internet Protocol (TCP/IP)**. You can then edit IP settings.

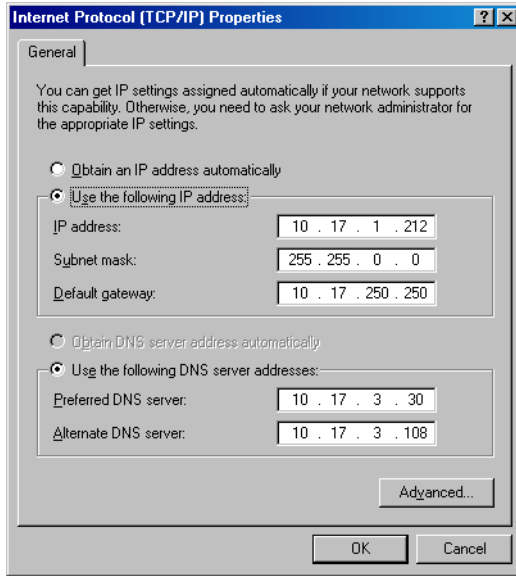

Figure 67 The TCP/IP properties window on Windows

To edit advanced settings, click **Advanced**.

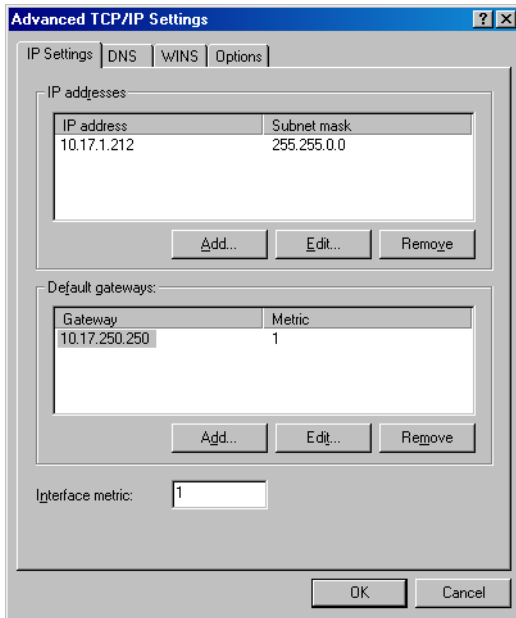

Figure 68 Advanced TCP/IP settings on Windows

DNS suffix

To configure the DNS suffix on a Windows 2000 system, right-click the **My Computer** icon on the desktop and then click **Properties, Network Identification, Properties, More**. The new DNS settings will take effect after the system is restarted.

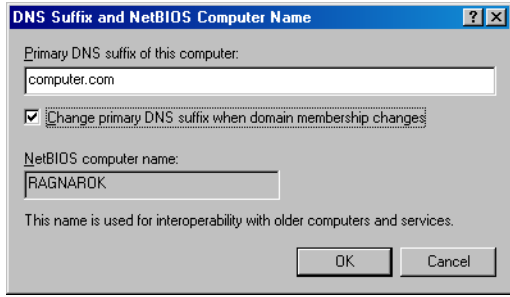

Figure 69 The DNS suffix and NetBIOS computer name on Windows

Checking the TCP/IP setup

An important aspect of the TCP/IP configuration process is the setup of a hostname resolution mechanism.

- If using hosts files, located in the `%SystemRoot%\system32\drivers\etc` folder, each system in the cell must be able to resolve the address of the Cell Manager, and of all systems with Media Agents and backup devices. The Cell Manager must be able to resolve the names of all systems in the cell.
- If using DNS, make sure the local DNS server is properly configured and specified in the IP settings for each system in the cell.

Once you have the TCP/IP protocol installed, you can use the `ping` and `ipconfig` utilities to verify that the TCP/IP setup is correct. If you have changed the TCP/IP settings, restart the computer first.

1. At the command line, type `ipconfig /all` to display the precise information on your TCP/IP configuration and the addresses that have been set for your network adapter. Check if the IP address and subnet mask are set correctly.
2. Type `ping your_IP_address` to confirm the software installation and configuration. By default, you should receive four echo packets.
3. Type `ping default_gateway`.

The gateway should be on your subnet. If you fail to ping the gateway, check if the gateway IP address is correct and that the gateway is operational.

4. If the previous steps have worked successfully, you are ready to test the name resolution. Enter the name of the system while running the `ping` command to test the hosts file and/or DNS. If your machine name was `kesukozi`, and the domain name was `campo.com`, you would enter: `ping kesukozi.campo.com`.

If this does not work, refer to

“[Installing and configuring the TCP/IP protocol on Windows](#)” on page 393, for steps required to access the `TCP/IP Properties` window. Here, verify that the domain name is correct. You should also check the hosts file and the DNS.

Be sure that the name resolution for the system, which is intended to be the Cell Manager, and the systems, which are intended to be the clients, is working in both ways:

- On the Cell Manager you can ping each client.
- On the clients you can ping the Cell Manager and each client with a Media Agent installed.

 **NOTE:**

When using the hosts file for the name resolution, the above test does not guarantee that name resolution works properly. In this case, you may want to use **DNS check tool** once Data Protector is installed.

 **IMPORTANT:**

If the name resolution, as specified above, is not working, Data Protector can not be installed properly.

Also note that the Windows computer name must be the same as the hostname. Otherwise, Data Protector setup reports a warning.

To check the hostname, refer to

“[Installing and configuring the TCP/IP protocol on Windows](#)” on page 393 for steps required to access the `TCP/IP Properties` window.

5. After Data Protector has been installed and a Data Protector cell has been created, you can use the DNS check tool to check that the Cell Manager and every client with a Media Agent installed resolve DNS connections to all other clients in the cell properly and vice versa. You do that by running the `omnicheck -dns` command from the `Data_Protector_home\bin` directory. Failed checks and the total number of failed checks are listed. For details, see [“Verifying DNS connections within Data Protector cell”](#) on page 334.

For detailed information on the `omnicheck` command, refer to the *HP Data Protector command line interface reference*.

MS Proxy

If the MS Proxy is installed, the port number 5555 is occupied and the Data Protector services fail. Solve the problem as follows:

1. Create a file, named `wspcfg.ini`, in the `Data_Protector_home\bin` directory.
2. Add the following lines to the file:

```
[OmniInet]Disable=1
```

Changing the Cell Manager name

When Data Protector is installed it uses the current hostname for the Cell Manager name. If you change the hostname of your Cell Manager, you need to update the Data Protector files manually.

IMPORTANT:

It is necessary to update the client information about the Cell Manager name. Before changing the hostname of your Cell Manager, export the clients from the cell. For the procedure, refer to [“Exporting clients from a cell”](#) on page 213. After you have changed the hostname, import the clients back to the cell. For the procedure, refer to the [“Importing clients to a cell”](#) on page 207.

NOTE:

Any devices and backup specifications that were configured using the old Cell Manager name must be modified to reflect the correct name.

On UNIX

On a UNIX Cell Manager, do the following:

1. Change the Cell Manager hostname entries in the following files:

```
/etc/opt/omni/client/cell_server  
/etc/opt/omni/server/cell/cell_info  
/etc/opt/omni/server/users/UserList
```
2. Verify that Name Resolution works among the members of a Data Protector cell.
3. Change the Cell Manager name in the IDB by running:

```
/opt/omni/sbin/omnidbutil -change_cell_name [old_host]
```

On Windows

On a Windows Cell Manager, do the following:

1. Change the Cell Manager hostname entries in the following files:

```
Data_Protector_home\config\server\cell\cell_info  
Data_Protector_home\config\server\users\userlist
```
2. Change the Cell Manager name in the following registry key:

```
\\HKEY_LOCAL_MACHINE\SOFTWARE\Hewlett-Packard\  
OpenView\OmniBack\Site\CellServer
```

Changing the default port number

The Data Protector `Inet` service (process), which starts other processes needed for backup and restore, should use the same port number on each system within the cell.

By default, Data Protector uses the port number 5555. To verify that this particular port number is not used by another program, you should view the `/etc/services` file on UNIX systems or run the `netstat -a` command on Windows systems. If the port number 5555 is already in use by another program, you must change this value to an unused port number. If the port number is not available only on client systems, you can change it after installing the Cell Manager. If the port number is not available on the system where you want to install the Cell Manager, you must change the port number before the installation.

UNIX

To change the port number on a UNIX system, follow the steps:

- Before you install the Cell Manager:
Create the file `/tmp/omni_tmp/socket.dat` with the required port number.
- After you installed the Cell Manager:

1. Edit the `/etc/services` file. By default, this file should contain the entry:

```
omni 5555/tcp # DATA-PROTECTOR
```

Replace the number 5555 with an unused port number.

2. If the files `/etc/opt/omni/client/customize/socket` and `/opt/omni/newconfog/etc/opt/omni/client/customize/socket` exist on the system, update their content with the required port number.
3. Restart the `Inet` service by terminating the process concerned using the `kill -HUP inetd_pid` command. To determine the process ID (`inetd_pid`), use the `ps -ef` command.
4. In the global options file, set a new value for the `Port` variable.
5. Restart the Data Protector services:

```
/opt/omni/sbin/omnisv stop
```

```
/opt/omni/sbin/omnisv start
```

Windows

To change the port number on a Windows system, follow the steps:

- Before you install the Cell Manager:
 1. From the command line, run `regedit` to open the Registry editor.
 2. Create the registry entry `InetPort` under the key `HKEY_LOCAL_MACHINE\SOFTWARE\Hewlett-Packard\OpenView\OmniBackII\Common`.
Name of the registry entry: `InetPort`
Type of the registry entry: `REG_SZ` (string)
Value of the registry entry: `port_number`
- After you installed the Cell Manager:
 1. From the command line, run `regedit` to open the Registry editor.
 2. Expand **HKEY_LOCAL_MACHINE, Software, Hewlett-Packard, OpenView, OmniBack**, and select **Common**.

3. Double-click **InetPort** to open the Edit String dialog box. In the Value data text box, enter an unused port number. The same must be done in the `Parameters` subfolder of the `Common` folder.
4. In the Windows Control Panel, go to Administrative Tools, Services, then select the **Data Protector Inet** service, and restart the service (click the **Restart** icon on the toolbar).

Novell NetWare

To change the port number on a Novell NetWare system, follow the steps:

1. Ensure that no Data Protector sessions are running in the cell.
2. From the Novell NetWare console, run the command `UNLOAD HPINET`.
3. Open the `AUTOEXEC.NCF` file and locate the following line in it:

```
LOAD HPINET.NLM -PORT 5555
```

Replace the entry `5555` with an unused port number.
4. Open the `SYS:\ETC\SERVICES` file and add the following line into it:

```
omni PortNumber/tcp
```

PortNumber must be the same as the port number used in step 3 of this procedure.
5. From the Novell NetWare console, run the command `WS2_32 RELOAD SERVICES` so that the file `SYS:\ETC\SERVICES` is re-read.
6. Run the command `LOAD HPINET` to reload `HPINET`.

Preparing a NIS server

This procedure enables your NIS server to recognize your Data Protector Cell Manager.

To add the Data Protector information to your NIS server, follow these steps:

1. Log in as `root` on the NIS server.

2. If you are managing the `/etc/services` file via NIS, append the following line to the `/etc/services` file:

```
omni 5555/tcp # Data Protector for Data Protector inet
server
```

Replace 5555 with an alternative if this port is not available. See [“Changing the default port number”](#) on page 399.

If you are managing the `/etc/inetd.conf` file via NIS, append the following line to the `/etc/inetd.conf` file:

```
#Data Protector
omni stream tcp nowait root /opt/omni/lbin/inet -log
/var/opt/omni/log/inet.log
```

3. Run the following command so that the NIS server reads the file and updates the configuration.

```
cd /var/yp; make
```



NOTE:

In the NIS environment, the `nsswitch.conf` file defines the order in which different configuration files will be used. For example, you can define whether the `/etc/inetd.conf` file will be used on the local machine or from the NIS server. You can also insert a sentence in the file, stating that the `nsswitch.conf` file controls where the names are kept. See the man pages for detailed information.

If you have already installed Data Protector, you must prepare the NIS server, and then restart the `inet` service by killing the process concerned, using the command `kill -HUP pid` on every NIS client that is also a Data Protector client.

Troubleshooting

- If the Data Protector Inet service does not start after you have installed Data Protector in your NIS environment, check the `/etc/nsswitch.conf` file.

If you find the following line:

```
services: nis [NOTFOUND=RETURN] files
```

replace the line with:

```
services: nis [NOTFOUND=CONTINUE] files
```

Using tape and robotics drivers on Windows

Data Protector supports the native tape drivers that are loaded by default for an enabled tape drive attached to a Windows system. The Windows native drivers loaded for Medium changers (robotics) devices are not supported by Data Protector.

In the examples below, an HP 4mm DDS tape device is attached to the Windows system. The native driver loaded for medium changer devices needs to be disabled if the HP 4mm DDS tape device is connected to the Windows system and will be configured for use with Data Protector. This section describes the related procedures.

Tape drivers

A driver is usually delivered with Windows, if the device is listed in the Hardware Compatibility List (HCL). HCL is a list of the devices supported by Windows and can be found at the following site:

<http://www.microsoft.com/whdc/hcl/default.msp>

The device drivers then load automatically for all enabled devices once the computer has been started. You do not need to load the native tape driver separately, but you can update it. To update or replace the native tape driver on a Windows system, proceed as follows:

1. In the Windows Control Panel, double-click **Administrative Tools**.
2. In the **Administrative Tools** window, double-click the **Computer Management**. Click **Device Manager**.
3. Expand Tape Drives. To check which driver is currently loaded for the device, right-click the tape drive and then click **Properties**.
4. Select the **Driver** tab and click **Update Driver**. See [Figure 70](#) on page 404. Then, follow the wizard, where you can specify if you want to update the currently installed native tape driver or replace it with a different one.
5. Restart the system to apply the changes.



Figure 70 Driver properties

 **IMPORTANT:**

If a device has already been configured for Data Protector without using the native tape driver, you have to rename the device files for all configured Data Protector backup devices that reference the particular tape drive (for example, from `scsi1:0:4:0` to `tape3:0:4:0`).

Refer to [“Creating device files \(SCSI Addresses\) on Windows”](#) on page 407 for details.

Robotics drivers

On Windows, the robotics drivers are automatically loaded for enabled tape libraries. In order to use the library robotics with Data Protector, you have to disable the respective driver.

An HP 1557A tape library using the 4mm DDS tapes is used in the example below. Proceed as follows to disable the automatically loaded robotics driver (`ddsmc.sys`) on a Windows system:

1. In the Windows Control Panel, double-click **Administrative Tools**.
2. In the Administrative Tools window, double-click the **Computer Management**. Click **Device Manager**.

-
-
3. In the Results Area of the Device Manager window, expand Medium Changers.

4. To check which driver is currently loaded, right-click the **4mm DDS Medium Changer** and then **Properties**.

Select the **Driver** tab and click **Driver details**. In this case, the following window will display:

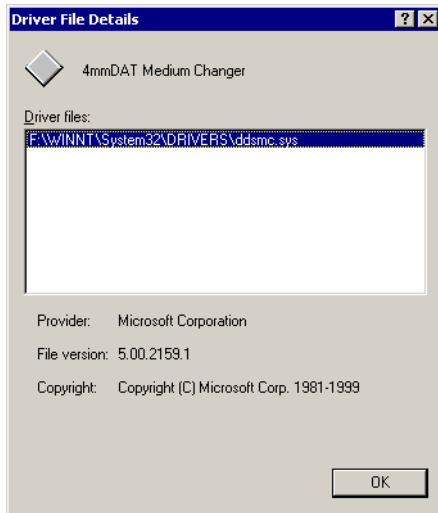

Figure 71 Medium changer properties

To disable the native robotics driver, right-click the **4mm DDS Medium Changer** and then select **Disable**.

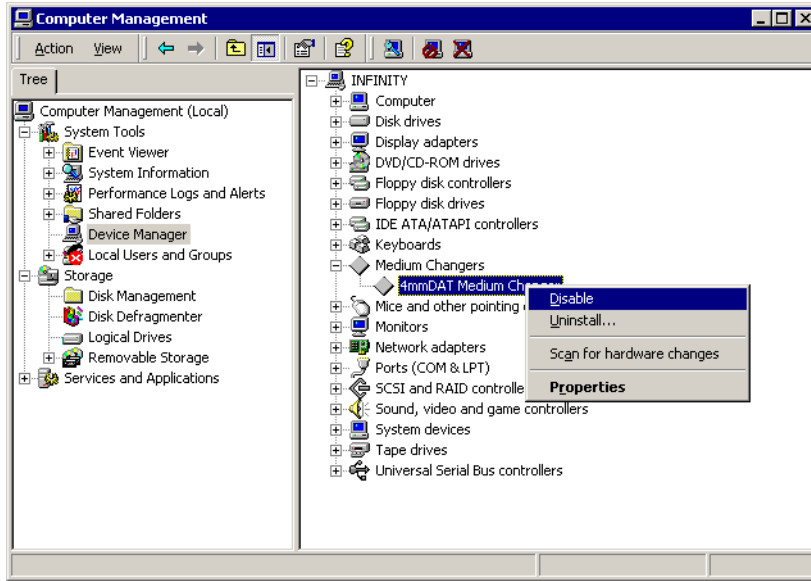

Figure 72 Disabling robotics drivers

5. Restart the system to apply the changes. The robotics can now be configured with Data Protector.

Creating device files (SCSI Addresses) on Windows

The tape device filename syntax depends on whether the native tape driver was loaded (`tapeN:B:T:L`) or unloaded (`scsiP:B:T:L`) for a tape drive.

Windows using the native tape driver

To create a device file for a tape drive connected to a Windows system that uses the native tape driver, proceed as follows:

1. In the Windows Control Panel, double-click **Administrative Tools**.
2. In the Administrative Tools window, double-click the **Computer Management**. Expand Removable Storage, then Physical Locations. Right-click the tape drive and select **Properties**.
3. If the native tape driver is loaded, the device file name is displayed in the General property page. Otherwise, you can find the relevant information in the Device Information property page. See [Figure 73](#) on page 408.

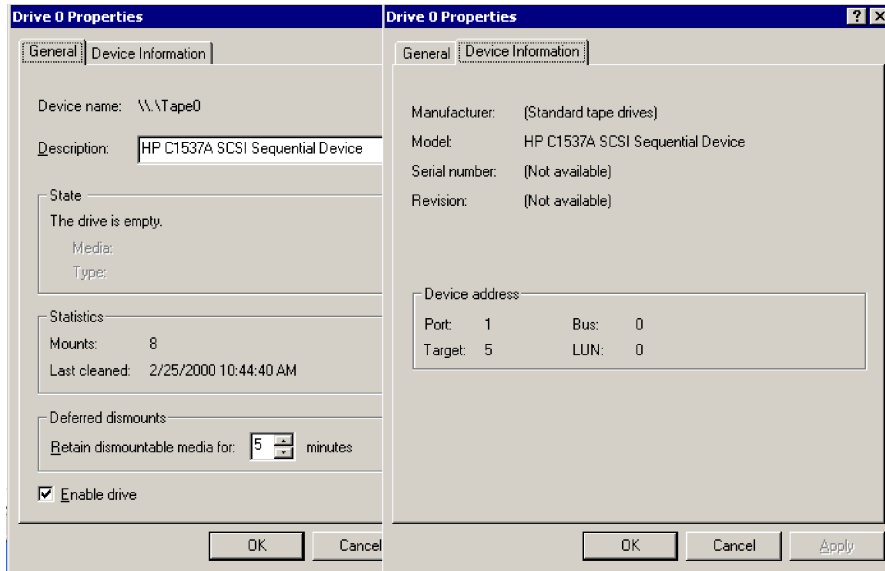

Figure 73 Tape drive properties

The file name for the tape drive in [Figure 73](#) on page 408 is created as follows:

Native Tape Driver Used Tape0 or
Tape0:0:5:0

Native Tape Driver NOT Used scsi1:0:5:0

Magneto-optical devices

If you connect a magneto-optical device to a Windows system, a drive letter is assigned to the device after you reboot the system. This drive letter is then used when you create the device file. For example, `E:` is the device file created for a magneto-optical drive which has been assigned a drive letter `E`.

SCSI robotics configuration on HP-UX

On the HP-UX systems, a SCSI Pass-Through Driver is used to manage the SCSI controller *and* control device (also referred to as robotics or picker) of the Tape Library devices (like HP StorageWorks 12000e). The control device in a library is responsible for loading/unloading media to/from the drives and importing/exporting media to/from such a device.

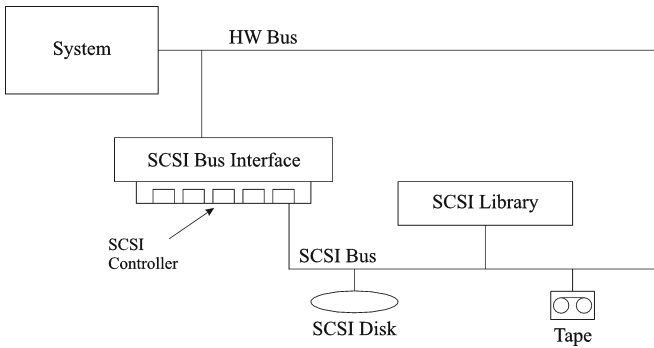

Figure 74 SCSI controlled devices

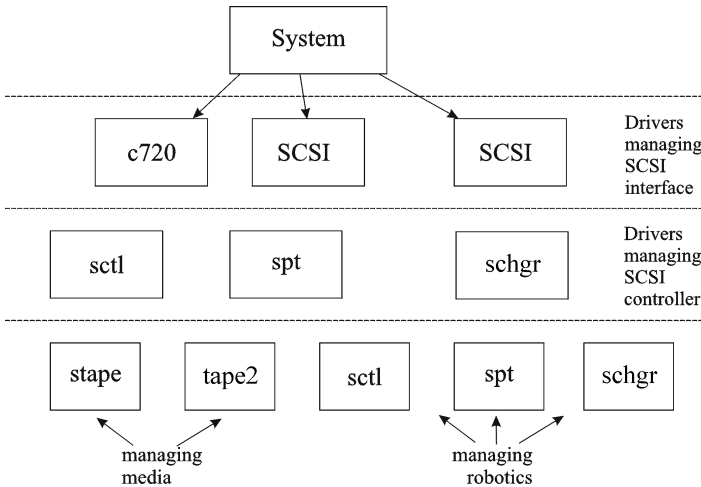

Figure 75 Managing devices

The type of SCSI Robotic Driver in use depends on the hardware. Systems equipped with the *GSC/HSC* or *PCI* bus have the SCSI Autochanger Driver named *schgr*, and systems equipped with the *EISA* bus have the SCSI Pass-Through Driver named *sctl*, which is already built in the kernel. However, the SCSI Pass-Through Driver used on HP Servers with an *NIO* Bus is named *spt*. It is installed on the system without being built into the kernel by default.

If the SCSI Robotic Driver driver has not already been linked to your current kernel, you have to add it yourself and assign it to the robotics of the connected Tape libraries.

The steps beneath explain how to *manually* add the SCSI Robotic Driver to the kernel and manually rebuild a new one.

**TIP:**

On the HP-UX platform, you can also build the kernel using the *HP System Administration Manager (SAM)* utility. See “[Installing HP-UX clients](#)” on page 93 in Chapter 2.

Use the `/opt/omni/sbin/ioscan -f` command to check whether or not the SCSI Robotic Driver is assigned to the library that you want to configure.

```

root@superhik$ ioscan -f
-----
Class      I  H/W Path      Driver      S/W State H/W Type  Description
-----
bc         0                root        CLAIMED   BUS_NEXUS
bc         1  8                ccio        CLAIMED   BUS_NEXUS  I/O Adapter
unknown   -1 8/0             CLAIMED   DEVICE    BSC-to-PCI Bus Bridge
ext_bus    0 8/12            c720        CLAIMED   INTERFACE BSC Fast/Wide SCSI Interfac
e
target    0 8/12.0          tgt         CLAIMED   DEVICE
disk      0 8/12.0.0        sdisk      CLAIMED   DEVICE    SEAGATE ST19171W
target    1 8/12.1          tgt         CLAIMED   DEVICE
tape      5 8/12.1.0        stape      CLAIMED   DEVICE    QUANTUM DLT7000
target    2 8/12.2          tgt         CLAIMED   DEVICE
ctl       0 8/12.2.0        sctl       CLAIMED   DEVICE    EXABYTE EXB-210
target    3 8/12.7          tgt         CLAIMED   DEVICE
ctl       0 8/12.7.0        sctl       CLAIMED   DEVICE
ba        0 8/16            bus_adapter CLAIMED   BUS_NEXUS  Core I/O Adapter
ext_bus    2 8/16/0          CentIf     CLAIMED   INTERFACE Built-in Parallel Interface
audio     0 8/16/1          audio      CLAIMED   INTERFACE Built-in Audio
tty       0 8/16/4          asio0     CLAIMED   INTERFACE Built-in RS-232C
ext_bus    1 8/16/5          c720        CLAIMED   INTERFACE Built-in SCSI
target    4 8/16/5.2        tgt         CLAIMED   DEVICE
disk      2 8/16/5.2.0      sdisk      CLAIMED   DEVICE    TOSHIBA CD-ROM XM-5401TA
target    7 8/16/5.3        tgt         NO_HW    DEVICE
tape      3 8/16/5.3.0      stape      NO_HW    DEVICE    SONY SDX-300C
target    6 8/16/5.5        tgt         NO_HW    DEVICE
tape      0 8/16/5.5.0      stape      NO_HW    DEVICE    SONY SDX-300C
target    5 8/16/5.7        tgt         CLAIMED   DEVICE

```

Figure 76 Status of the SCSI pass-through driver (sctl)

In [Figure 76](#) on page 410, you can see the `sctl` SCSI Pass-Through Driver assigned to the control device of the Exabyte tape device. The matching hardware path (H/W Path) is `8/12.2.0`. (SCSI=2, LUN=0)

There is also a tape drive connected to the same SCSI bus, but the driver controlling the tape drive is `stape`. The matching hardware path (H/W Path) is `8/12.1.0`. (SCSI=0, LUN=0)

**IMPORTANT:**

The SCSI address 7 is always used by SCSI controllers, although the corresponding line may not appear in the output of the `ioscan -f` command. In this example, the controller is managed by `sctl`.

```
# ioscscan -f
Class      I  H/W Path  Driver  S/W State H/W Type  Description
-----
bc         0          root    CLAIMED  BUS_NEXUS
ext_bus    0  52        scsi1   CLAIMED  INTERFACE HP 20655A - SCSI Interface
target     4  52.1      target  CLAIMED  DEVICE
disk       4  52.1.0    disc3   CLAIMED  DEVICE      SEAGATE ST15150N
target     1  52.2      target  CLAIMED  DEVICE
disk       0  52.2.0    disc3   CLAIMED  DEVICE      TOSHIBA CD-ROM XM-4101TA
target     3  52.4      target  CLAIMED  DEVICE
tape       0  52.4.0    tape2   CLAIMED  DEVICE      HP C1533A
spt        1  52.4.1    spt     CLAIMED  DEVICE      HP C1553A
target     6  52.5      target  CLAIMED  DEVICE
disk       5  52.5.0    disc3   CLAIMED  DEVICE      SEAGATE ST15150N
target     2  52.6      target  CLAIMED  DEVICE
disk       1  52.6.0    disc3   CLAIMED  DEVICE      SEAGATE ST15150N
lammux    0  56        lammux0 CLAIMED  INTERFACE LAN/Console
tty        0  56.0      mux4    CLAIMED  INTERFACE
lan        0  56.1      lan3    CLAIMED  INTERFACE
lanttty   0  56.2      lanttty CLAIMED  INTERFACE
processor  0  62        processor CLAIMED  PROCESSOR Processor
memory     0  63        memory  CLAIMED  MEMORY      Memory
# █
```

Figure 77 Status of the SCSI pass-through driver - spt

In [Figure 77](#) on page 411, you can see an example of a connected tape device with robotics controlled by the `spt` SCSI Pass-Through Driver. The particular device is an HP StorageWorks 12000e tape library device that uses the SCSI address 4 and is connected to the SCSI bus with the H/W Path 52. The matching hardware path is 52.4.1. The robotics is correctly assigned to the `spt` SCSI Pass-Through Driver.

If the `sctl`, `spt`, or `schgr` driver is not assigned to the robotics, you have to add the H/W Path of the robotics to the driver statement in the `system` file and rebuild the kernel. Follow the procedure below.

The following procedure explains how to *manually* add a SCSI Robotic Driver to the kernel, assign it to the robotics, and then manually rebuild a new kernel:

1. Login as a `root` user and switch to the build directory:

```
cd /stand/build
```

2. Create a new system file from your existing kernel:

```
/usr/sbin/sysadm/system_prep -s system
```

3. Check which SCSI Robotic Driver is already built in your current kernel. From the `/stand` directory, enter the following command:

```
grep SCSI Robotic Driver system
```

where the *SCSI Robotic Driver* can be either `spt`, `sctl`, or `schgr`. The `system` will display the corresponding line if the driver is already built in the current kernel.

4. Use an editor to append a driver statement:

```
driver H/W Path spt
```

to the `/stand/build/system` file, where *H/W Path* is the complete hardware path of the device.

For the HP StorageWorks 12000e Tape library from the previous example you would enter:

```
driver 52.4.1 spt
```

For several libraries connected to the same system, you have to add a driver line for each library robotics with the appropriate hardware path.

When configuring the `schgr` driver, append the following line to a driver statement:

```
schgr
```

5. Enter the `mk_kernel -s./system` command to build a new kernel.
6. Save the original old system file using a different name and move the new system file to the original name so that it becomes the current one:

```
mv /stand/system /stand/system.prev
```

```
mv /stand/build/system /stand/system
```

7. Save the old kernel with a different name and move the new kernel to the original name so that it becomes the current one:

```
mv /stand/vmunix /stand/vmunix.prev
```

```
mv /stand/vmunix_test /stand/vmunix
```

8. Reboot the system from the new kernel by entering the following command:

```
shutdown -r 0
```

9. Once you have rebooted the system, verify the changes you have made using the `/usr/sbin/ioscan -f` command.

Creating device files on HP-UX

Prerequisites

Before you create a device file, you should have the backup device already connected to the system. Use the `/usr/sbin/ioscan -f` command to check whether the

device is properly connected. Use the `/usr/sbin/infs -e` command to create device files for some backup devices automatically.

If the device files that correspond to a particular backup device have not been created during the system initialization (boot process) or after running the `infs -e` command, you have to create them manually. This is the case with the device files required to manage the library control device (library robotics).

We will use an example of creating a device file for the robotics of the HP StorageWorks 12000e library device connected to an HP-UX system. The device file for the tape drive has already been created automatically after the reboot of the system, while the device file for the control device must be created manually.

In [Figure 77](#) on page 411, you can see the output of the `ioscan -f` command on the selected HP-UX system.

```
# ioscan -f
Class I H/W Path Driver S/W State H/W Type Description
-----
bc 0 root CLAIMED BUS NEXUS
ext_bus 0 52 scsi1 CLAIMED INTERFACE HP 28655A - SCSI Interface
target 4 52.1 target CLAIMED DEVICE
disk 4 52.1.0 disc3 CLAIMED DEVICE SEAGATE ST15150N
target 1 52.2 target CLAIMED DEVICE
disk 0 52.2.0 disc3 CLAIMED DEVICE TOSHIBA CD-ROM XM-4101TA
target 3 52.4 target CLAIMED DEVICE
tape 0 52.4.0 tape2 CLAIMED DEVICE HP C1533A
spt 1 52.4.1 spt CLAIMED DEVICE HP C1553A
target 6 52.5 target CLAIMED DEVICE
disk 5 52.5.0 disc3 CLAIMED DEVICE SEAGATE ST15150N
target 2 52.6 target CLAIMED DEVICE
disk 1 52.6.0 disc3 CLAIMED DEVICE SEAGATE ST15150N
lanmux 0 56 lanmux0 CLAIMED INTERFACE LAN/Console
tty 0 56.0 mux4 CLAIMED INTERFACE
lan 0 56.1 lan3 CLAIMED INTERFACE
lantty 0 56.2 lantty0 CLAIMED INTERFACE
processor 0 62 processor CLAIMED PROCESSOR Processor
memory 0 63 memory CLAIMED MEMORY Memory
#
```

Figure 78 List of connected devices

The SCSI bus interface is controlled by the `scsi1` system driver. This is a SCSI NIO interface. To access the library robotics on the SCSI NIO bus we must use the `spt` SCSI Pass-Through driver that is already installed and assigned to the robotics of the HP StorageWorks 12000e Tape device that uses the hardware path `52.4.1`.



NOTE:

If you do not use a SCSI NIO based bus interface, the `spt` driver is not required but the `sc11` driver is used instead.

To create the device file, you need to know the *Major number* character of the SCSI Pass-Through driver and the *Minor Number* character, which does not depend on the SCSI Pass-Through driver you use.

To obtain the character *Major number* belonging to `spt`, run the system command:

```
lsdev -d spt
```

In the example (see [Figure 78](#) on page 413) the command reported the *Major number* character 75.

To obtain the character *Major number* belonging to `sct1`, run the system command:

```
lsdev -d sct1
```

In our case, the command reported the *Major number* character 203.

The *Minor Number* character, regardless of which SCSI Pass-Through driver is in use, has the following format:

```
0xIIITL00
```

I -> The *Instance number* of the SCSI bus interface (NOT of the device) reported by the `ioscan -f` output is in the second column, labeled with **I**. In the example, the instance number is 0, so we must enter two hexadecimal digits, 00.

T -> The SCSI address of the library robotics. In the example, the SCSI address is 4, so we must enter 4.

L -> The LUN number of the library robotics. In the example, the LUN number is 1, so we must enter 1.

00 -> Two hexadecimal zeroes.

Creating the device file

The following command is used to create the device file:

```
mknod /dev/spt/devfile_name c Major # Minor #
```

Usually the device files for `spt` are located in the `/dev/spt` or `/dev/scsi` directory. In this case, we will name the control device file `/dev/spt/SS12000e`.

Thus, the complete command for creating a device file named `SS12000e` in the `/dev/spt` directory is:

```
mknod /dev/spt/SS12000e c 75 0x004100
```

If we create a device file for `sct1`, which is named `SS12000e` and located in the `/dev/scsi` directory, the complete command is:

```
mknod /dev/scsi/SS12000e c 203 0x004100
```

Setting a SCSI controller's parameters

Data Protector allows you to change the device's block size, which requires an additional configuration on some SCSI controllers: in order to enable writing of block sizes larger than 64K, some SCSI controllers need to have their parameters set differently.

On Windows systems, you set the SCSI controller's parameters by editing the registry value for Adaptec SCSI controllers, and for some controllers with Adaptec's chipsets:

1. Set the following registry value:
`\\HKEY_LOCAL_MACHINE\SYSTEM\CurrentControlSet\Services\aic78xx\Parameters\Device0\MaximumSGList`
2. Enter a `DWORD` value containing the number of 4 kB blocks, increased by one.
$$\text{MaximumSGList} = (\text{OBBlockSize in kB} / 4) + 1$$

For example, to enable block sizes up to 260 kB, `MaximumSGList` has to be at least $(260 / 4) + 1 = 66$.
3. Restart the system.

 **NOTE:**

This registry value sets the upper limit of the block size. The actual block size for a device must be configured using the Data Protector GUI for device configuration.

Finding the unused SCSI addresses on HP-UX

A backup device connected to an HP-UX system is accessed and controlled through a device file that must exist for each physical device. Before you can create the device file, you have to find out which SCSI addresses (ports) are still unused and available for a new device.

On HP-UX, the `/usr/sbin/ioscan -f system` command is used to display the list of the SCSI addresses that are already occupied. Thus, the addresses not listed in the output of the `/usr/sbin/ioscan -f` command are still unused.

In [Figure 79](#) on page 416, there is the output of the `/usr/sbin/ioscan -f` command on an HP-UX 11.x system.

```
# ioscan -f
Class      I  H/W Path  Driver  S/W State H/W Type  Description
-----
bc         0          root    CLAIMED  BUS_NEXUS
ext_bus   0  52        scs11   CLAIMED  INTERFACE HP 28655A - SCSI Interface
target    4  52.1      target  CLAIMED  DEVICE
disk      4  52.1.0    disc3   CLAIMED  DEVICE      SEAGATE ST15150N
target    1  52.2      target  CLAIMED  DEVICE
disk      0  52.2.0    disc3   CLAIMED  DEVICE      TOSHIBA CD-ROM XM-4101TA
target    3  52.4      target  CLAIMED  DEVICE
tape      0  52.4.0    tape2   CLAIMED  DEVICE      HP C1533A
spt       1  52.4.1    spt     CLAIMED  DEVICE      HP C1553A
target    6  52.5      target  CLAIMED  DEVICE
disk      5  52.5.0    disc3   CLAIMED  DEVICE      SEAGATE ST15150N
target    2  52.6      target  CLAIMED  DEVICE
disk      1  52.6.0    disc3   CLAIMED  DEVICE      SEAGATE ST15150N
lammux   0  56        lammux0 CLAIMED  INTERFACE LAN/Console
tty       0  56.0      mux4    CLAIMED  INTERFACE
lan       0  56.1      lan3    CLAIMED  INTERFACE
lantty   0  56.2      lantty0 CLAIMED  INTERFACE
processor 0  62        processor CLAIMED  PROCESSOR Processor
memory   0  63        memory  CLAIMED  MEMORY      Memory
# █
```

Figure 79 The output of `ioscan -f` on an HP-UX system:

Only the third (H/W Path) and the fifth (S/W State) columns are relevant for the purpose of determining the available SCSI addresses. A dismembered (H/W Path) format would look like this:

SCSI_bus_H/W_Path.SCSI_address.LUN_number

In this particular case, there is just one SCSI bus, using the H/W Path 52. On this bus, you can use the SCSI addresses 0 and 3 because they do not appear in the list.

You can see in [Figure 79](#) on page 416 which SCSI addresses on the selected SCSI bus are already occupied:

- SCSI address 1 by a SCSI disk
- SCSI address 2 by a CD-ROM
- SCSI address 4, LUN 0, by a tape drive
- SCSI address 4, LUN 1, by the tape library robotics
- SCSI address 5 by a SCSI disk
- SCSI address 6 by a SCSI disk
- SCSI address 7 by a SCSI controller



NOTE:

The SCSI address number 7 is *not* listed although it is, by default, occupied by the SCSI controller.

All devices have the S/W State value set to CLAIMED and the H/W Type value set to H/W DEVICE, meaning that the devices are currently connected. If there was

an UNCLAIMED value in the S/W State or NO-HW in the H/W Type column it would mean that the system cannot access the device.

The SCSI address 4 is claimed by the tape library that has the tape drive with LUN 0 and the robotics with LUN 1. The drive is controlled by the `tape2` driver and the robotics is controlled by the `spt` SCSI Pass-Through driver. Looking at the description, you can see that the device is an HP StorageWorks 12000e library; it is easily recognized among the SCSI libraries because it uses the same SCSI address for the tape drive and robotics but uses different LUNs.

The whole SCSI bus is controlled by the `scsi1` interface module.

Finding the unused SCSI target IDs on Solaris

A backup device connected to a Solaris system is accessed and controlled through a device file. This device file is created automatically by the Solaris operating system, in the directory `/dev/rmt`, when the backup device is connected and the client system and backup device are powered up.

Before the backup device is connected, however, the available SCSI addresses must be checked and the address of the backup device set to an address not already allocated.

To list the available SCSI addresses on a Solaris system:

1. Stop the system by pressing **Stop** and **A**.
2. Run the **probe-scsi-all** command at the `ok` prompt:

```
probe-scsi-all
```

You may be asked by the system to start the `reset-all` command before executing the `probe-scsi-all` command

3. To return to normal operation, enter **go** at the `ok` prompt:

```
go
```

After listing the available addresses and choosing one to use for your backup device, you must update the relevant configuration files before connecting and starting up the device. Refer to the next section for instructions on updating the configuration files.

Updating the device and driver configuration on a Solaris system

Updating configuration files

The following configuration files are used for device and driver configuration. They must be checked, and if necessary, edited before attached devices can be used:

- `st.conf`
- `sst.conf`

`st.conf`: all devices

This file is required on each Data Protector Solaris client with a tape device connected. It must contain device information and one or more SCSI addresses for each backup device connected to that client. A single SCSI entry is required for a single-drive device and multiple SCSI entries are required for a multi-drive library device.

1. Check the unused SCSI addresses on the client, as described in the previous section, and choose an address for the device you want to attach.
2. Set the chosen SCSI address(es) on the backup device.
3. Power down the client system.
4. Attach the backup device.
5. First power up the device and then the client system.
6. Stop the system by pressing `Stop` and `A`.
7. Enter the **`probe-scsi-all`** command at the `ok` prompt:

```
probe-scsi-all
```

This will provide information on the attached SCSI devices, including the correct device ID. string for the newly attached backup device.

8. Return to normal running:

```
go
```

9. Edit the `/kernel/drv/st.conf` file. This file is used by the Solaris `st` (SCSI tape) driver. It contains a list of devices officially supported by Solaris and a set of configuration entries for third party devices. If you are using a supported device, it should be possible to connect the device and use it without any further configuration. Otherwise, you should add the following types of entries to `st.conf`:

- A tape configuration list entry (plus a tape data variable definition). Example entries are supplied in the file, commented out. You can use one of these, if applicable, or modify one to suit your needs.

The entry must come before the first `name=` entry in the file and the required format is as follows:

```
tape-config-list= "Tape unit", "Tape reference name", "Tape data";
```

where:

Tape unit

The vendor and product ID string for the tape device. This must be correctly specified as described in the device manufacturer's documentation.

Tape reference name

The name you choose, by which the system will identify the tape device. The name you provide does not change the tape product ID, but when the system boots, the reference name will be displayed in the list of peripheral devices recognized by the system.

Tape data

A variable that references a series of additional tape device configuration items. The variable definition must also be supplied and be correctly specified, as described in the device manufacturer's documentation.

For example:

```
tape-config-list= "Quantum DLT4000", "Quantum DLT4000",  
"DLT-data";
```

```
DLT-data = 1,0x38,0,0xD639,4,0x80,0x81,0x82,0x83,2;
```

The second parameter, 0x38, designates the DLTape tape type as "other SCSI drive". The value specified here should be defined in `/usr/include/sys/mtio.h`.



NOTE:

Ensure that the last entry in the tape-config-list is terminated with a semi-colon (;).

- For multidrive devices, target entries as follows:

```
name="st" class="scsi"
```

```
target=X lun=Y;
```

where:

X is the SCSI port assigned to the data drive (or robotic mechanism).

Y is the logical unit value.

For example:

```
name="st" class="scsi"
```

```
target=1 lun=0;
```

```
name="st" class="scsi"
```

```
target=2 lun=0
```

Normally target entries are required in `st.conf` only for the drives, not for the robotics mechanism, which is on a different target. Entries for these are usually provided in the `sst.conf` file (See below). However, there are some devices, for example the HP StorageWorks 24x6, that treat the robotics mechanism similar to another drive. In this case two entries with the same target are required (one for the drive and one for the robotics), but with different LUNs.

For example:

```
name="st" class="scsi"
```

```
target=1 lun=0;
```

```
name="st" class="scsi"
```

```
target=1 lun=1
```

sst.conf: library devices

This file is required on each Data Protector Solaris client to which a multi-drive library device is connected. Generally speaking, it requires an entry for the SCSI address of the robotic mechanism of each library device connected to the client (there are some exceptions, such as the HP StorageWorks 24x6 mentioned in the previous section).

1. Copy the `sst` driver (module) and configuration file `sst.conf` to the required directory:

- For 32-bit operating systems:

```
$cp /opt/omni/spt/sst /usr/kernel/drv/sst
```

```
$cp /opt/omni/spt/sst.conf /usr/kernel/drv/sst.conf
```

- For 64-bit operating systems:

```
$cp /opt/omni/spt/sst.64bit /usr/kernel/drv/sparcv9/sst
```

```
$cp /opt/omni/spt/sst.conf /usr/kernel/drv/sst.conf
```

2. Edit the `sst.conf` file and add the following entry:

```
name="sst" class="scsi" target=X lun=Y;
```

where:

`X` is the SCSI address of the robotic mechanism.

`Y` is the logical unit.

For example:

```
name="sst" class="scsi" target=6 lun=0;
```

3. Add the driver to the Solaris kernel:

```
add_drv sst
```

Creating and checking device files

After setting up the configuration files and installing the drivers, you can create new device files as follows:

1. Remove all existing device files from the `/dev/rmt` directory:

```
cd /dev/rmt rm *
```

2. Enter the following to shut down the system:

```
shutdown -i0 -g0
```

3. Reboot the system:

```
boot -rv
```

The `r` switch in the `boot` command enables a kernel compile and includes the creation of device special files used for communication with the tape device. The `v` switch enables verbose mode display of system startup. With verbose mode, the system should indicate that the device is attached by displaying the *Tape reference name* string you selected during the `/devices` directory configuration phase of boot.

4. Enter the following command to verify the installation:

```
mt -t /dev/rmt/0 status
```

The output of this command depends on the configured drive. It will be similar to the following:

```
Quantum DLT7000 tape drive: sense key(0x6)= Unit Attention  
residual= 0 retries= 0 file no= 0 block no= 0
```

5. When the reboot has completed, you can check the device files that have been created using the command `ls -all`. For a library device, the output of this command might be:

```
/dev/rmt/0hb          for a first tape drive
```

```
/dev/rmt/1hb          for a second tape drive
```

```
/dev/rsst6            for a robotic drive
```

Finding unused SCSI target IDs on a Windows system

Follow the steps below to determine the unused SCSI Target IDs (SCSI Addresses) on a Windows system:

1. In the Windows Control Panel, click **SCSI Adapters**.

2. For each device connected to a SCSI Adapter in the list, check its properties. Double-click the name of a device, and then click **Settings** to open the property page. See [Figure 80](#) on page 423.

Remember the SCSI Target IDs and LUNs (Logical Unit Numbers) assigned to the device. This way you can find out which SCSI Target IDs and LUNs are already occupied.

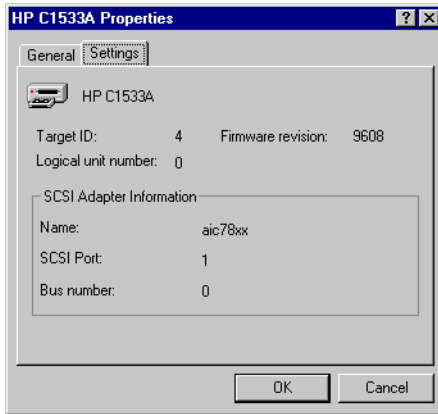

Figure 80 Device settings

Setting SCSI IDs on an HP StorageWorks 330fx library

Once you have chosen the unused SCSI IDs for the robotics and drives, you can check and configure them using the Control Panel of the library device.

EXAMPLE: If you have a library model HP StorageWorks 330fx, you can find the configured SCSI IDs as follows:

1. From the READY state, press **NEXT**, and then ADMIN* will appear.
2. Press **ENTER**, and then you will be asked for the password. Enter the password.
3. TEST* will appear, press **NEXT** until SCSI IDs* appears.
4. Press **ENTER**. VIEW IDs* appears.
5. Press **ENTER**. JKBX ID 6 LUN 0 appears.
6. Press **NEXT**. DRV 1 ID 5 LUN 0 appears.
7. Press **NEXT**. DRV 2 ID 4 LUN 0 appears, etc.

You can return to the `READY` state by pressing `CANCEL` several times.

Connecting backup devices

The following procedure describes the general steps to follow in order to connect a backup device to an HP-UX, Solaris, Linux or Windows system.

1. Select the client to which you will connect the backup device.
2. Install a Media Agent on the selected system. See [“Remote installation of Data Protector clients”](#) on page 77.
3. Determine the unused SCSI address that can be used by the device. For HP-UX systems, see [“Finding the unused SCSI addresses on HP-UX”](#) on page 415. For Solaris systems, see [“Finding the unused SCSI target IDs on Solaris”](#) on page 417. For a Windows system, see [“Finding unused SCSI target IDs on a Windows system”](#) on page 422.
 - If connecting to an HP-UX system, check that the required drivers are *installed* and *built* into the current kernel. See [“Checking the kernel configuration on HP-UX”](#) on page 94.
If you need to configure a SCSI Pass-Through Driver, see [“SCSI robotics configuration on HP-UX”](#) on page 408.
 - If connecting to a Solaris system, check that the required drivers are installed and the configuration files are updated for the device to be installed. See [“Updating the device and driver configuration on a Solaris system”](#) on page 418. This also tells you how to update the `sst.conf` file if you need to configure a SCSI Pass-Through Driver.
 - If connecting to a Windows client, the native tape driver can be loaded or disabled, depending on the Windows system version. See [“Using tape and robotics drivers on Windows”](#) on page 403.
If you load the native tape driver for a device which has been already configured in Data Protector and did not use the native tape driver, make sure that you rename the device filenames for all configured Data Protector logical devices that reference this specific device (for example, from `scsi1:0:4:0` to `tape3:0:4:0`).
For more information on an appropriate device filename, see [“Creating device files \(SCSI Addresses\) on Windows”](#) on page 407.

4. Set the SCSI addresses (IDs) on the device. Depending on the device type, this can be usually done using the switches on the device. For details, see the documentation that comes with the device.

For an example, see

“[Setting SCSI IDs on an HP StorageWorks 330fx library](#)” on page 423.

Refer to <http://www.hp.com/support/manuals> for details about supported devices.

 **NOTE:**

On a Windows systems with the Adaptec SCSI adapter installed and a SCSI device connected, the `Host Adapter BIOS` option must be enabled so that the system does not have problems issuing SCSI commands.

To set the Host Adapter BIOS option, press **Ctrl+A** during the boot of the system to enter the SCSI Adapter menu, then select

Configure/View Host Adapter Settings > Advanced Configuration Options and enable Host Adapter BIOS.

5. First, switch on the device, and then the computer, and then wait until the boot process completes. Verify that the system correctly recognizes your new backup device.

- On an HP-UX system, use the `ioscan` utility

```
/usr/sbin/ioscan -fn
```

to display a list of connected devices with the corresponding hardware paths and device files, where you should find your newly connected device with the correct SCSI addresses.

If the device file has not been created automatically, during the boot process, you must create it manually. See [“Creating device files on HP-UX”](#) on page 412.

- On a Solaris system, run the `ls -all` command on the `/dev/rmt` directory to display a list of connected devices with the corresponding hardware paths and device files, where you should find your newly connected device with the correct SCSI addresses.
- On a Linux system, run the `ls -all` command on the `/dev/rmt` directory to display a list of connected devices with the corresponding hardware paths and device files, where you should find your newly connected device with the correct SCSI addresses.
- On a Windows system, you can verify that the system correctly recognizes your new backup device if you use the `devbra` utility. In the `Data_Protector_home\bin` directory, run:

```
devbra -dev
```

In the output of the `devbra` command you will find the following lines for each connected and properly recognized device:

```
backup device specification
hardware_path
media_type
.....
```

For example, the following output:

```
HP:C1533A
tape3:0:4:0
DDS
...
...
```

means that an HP DDS tape device (with the native tape driver loaded) has the Drive instance number 3, and is connected to the SCSI bus 0, the SCSI Target ID 4 and LUN number 0.

Or, the following output:

```
HP:C1533A
scsi1:0:4:0
DDS
...
...
```

means that an HP DDS tape device (with the native tape driver unloaded) is connected to the SCSI port 1, SCSI bus 0, and the tape drive has the SCSI Target ID 4, and LUN number 0.

- On an AIX system, use the `lsdev` utility

```
lsdev -C
```

to display the list of connected devices with the corresponding device files.

Hardware compression

Most modern backup devices provide built-in hardware compression that can be enabled when you create a device file or SCSI address in the device configuration procedure. Refer to the online Help for detailed steps.

Hardware compression is done by a device that receives the original data from a Media Agent client and writes it to the tape in compressed mode. Hardware compression increases the speed at which a tape drive can receive data, because less data is written to the tape.

When software compression is used and hardware compression is disabled, the data is compressed by the Disk Agent and sent compressed to a Media Agent. The compression algorithm can take a substantial amount of resources from the Disk Agent system if software compression is used, but this reduces the network load.

To enable hardware compression on Windows, add "C" to the end of the device/drive SCSI address, for example: `scsi:0:3:0C` (or `tape2:0:1:0C` if tape driver is loaded). If the device supports hardware compression, it will be used, otherwise the C option will be ignored.

To disable hardware compression on Windows, add "N" to the end of the device/drive SCSI address, for example: `scsi:0:3:0:N`.

To enable/disable hardware compression on UNIX, select a proper device file. Consult the device and operating system documentation for details.

What's next?

At this stage, you should have the backup devices connected that enable you to configure backup devices and media pools. See the online Help index: “configuring, backup devices” for more information about further configuration tasks.

You must have a Media Agent installed on your system. See “[Remote installation of Data Protector clients](#)” on page 77 for instructions how to do that.

The following sections describe how to connect an HP StorageWorks Standalone 24 Tape Device, HP StorageWorks 12000e Library, and HP StorageWorks DLT Library 28/48-Slot to an HP-UX and a Windows system.

Connecting an HP StorageWorks 24 standalone device

The StorageWorks 24 DDS backup device is a standalone tape drive based on DDS3 technology.

Connecting to an HP-UX system

Follow the steps below to connect the HP StorageWorks 24 Standalone device to an HP-UX system:

1. Check that the required drivers (`stape` or `tape2`) are *installed* and *built* into the current kernel. See “[Checking the kernel configuration on HP-UX](#)” on page 94.
2. Determine an unused SCSI address that can be used by the tape drive. See “[Finding the unused SCSI addresses on HP-UX](#)” on page 415.
3. Set the SCSI addresses (IDs) on the device. Use the switches at the back of the device.

For details, see the documentation that comes with the device.

4. First, switch on the device, and then the computer, and wait until the boot process completes.
5. Verify that the system correctly recognizes the newly connected tape drive. Use the `ioscan` utility:

```
/usr/sbin/ioscan -fn
```

to display a list of connected devices with the corresponding hardware paths and device files, where you should find your newly connected tape drive, which has the correct SCSI address. The device file for the drive has been created during the boot process.

What's next?

After properly connecting the device, see the online Help index: "configuring, backup devices" for instructions about configuring a Data Protector backup device for your newly connected device.

Connecting to a Windows system

Follow the steps below to connect the HP StorageWorks 24 Standalone device to a Windows system:

1. Determine an unused SCSI address (Target ID) that can be used by the tape drive. See "[Finding unused SCSI target IDs on a Windows system](#)" on page 422.
2. Set the SCSI addresses (IDs) on the device. Use the switches at the back of the device. For details, see the documentation that comes with the device.
3. First, switch on the device, and then the computer, and then wait until the boot process completes.
4. Verify that the system correctly recognizes the newly connected tape drive. Run the `devbra` command from the `Data_Protector_home\bin` directory. Enter

```
devbra -dev
```

In the output of the `devbra` command, you should find the newly connected tape drive of the HP StorageWorks 24 Standalone device.

What's next?

After properly connecting the device, see the online Help index: "configuring, backup devices" for instructions about configuring a Data Protector backup device for your newly connected device.

Connecting an HP StorageWorks DAT Autoloader

Both the HP StorageWorks 12000e and the StorageWorks DAT24x6 libraries have a repository for six cartridges, one drive, and one robotic arm used for moving cartridges to and from the drive. The two libraries also have built-in dirty tape detection.

Connecting to an HP-UX system

Follow the steps below to connect the HP StorageWorks 12000e library device to an HP-UX system:

1. On the rear side of the autoloader, set the mode switch to 6 .

2. Check that the required drivers (`stape` or `tape2`) are *installed* and *built* into the current kernel. See [“Checking the kernel configuration on HP-UX”](#) on page 94.
3. Check that the required SCSI Pass-Through drivers (`sctl` or `spt`) are *installed* and *built* into the current kernel. See [“SCSI robotics configuration on HP-UX”](#) on page 408.
4. Determine an unused SCSI address that can be used by the tape drive and the robotics. See [“Finding the unused SCSI addresses on HP-UX”](#) on page 415.

 **NOTE:**

The HP StorageWorks 12000e Library uses the same SCSI address for the tape drive and for the robotics, but uses different LUN numbers.

5. Set the SCSI addresses (IDs) on the device. For details, see the documentation that comes with the device.
6. First, switch on the device, and then the computer, and then wait until the boot process completes.
7. Verify that the system correctly recognizes the newly connected tape drive. Use the `ioscan` utility

```
/usr/sbin/ioscan -fn
```

to display a list of connected devices with the corresponding hardware paths and device files, where you should find your newly connected tape drive, having the correct SCSI address.

8. The device file for the drive has been created during the boot process, while the device file for the robotics must be created manually. See [“Creating device files on HP-UX”](#) on page 412.
9. Verify that the system correctly recognizes the newly created device file for the library robotics. Run the `ioscan` utility:

```
/usr/sbin/ioscan -fn
```

You should see your newly created device file in the output of the command.

What's next?

After properly connecting the library device, see the online Help index: “configuring, backup devices” for instructions about configuring a Data Protector backup device for your newly connected device.

Connecting to a Windows system

Follow the steps below to connect the HP StorageWorks 12000e library device to a Windows system:

1. On the rear side of the autoloader, set the mode switch to 6 .
2. Determine an unused SCSI address that can be used by the tape drive and for the robotics. See [“Finding unused SCSI target IDs on a Windows system”](#) on page 422.
3. Set the SCSI addresses (IDs) on the device. For details, see the documentation that comes with the device.

 **NOTE:**

The HP StorageWorks 12000e Library uses the same SCSI address for the tape drive and for the robotics, but uses different LUN numbers.

4. First, switch on the device, and then the computer, and wait until the boot process completes.
5. Verify that the system correctly recognizes the newly connected tape drive and the robotics. In the `Data_Protector_home\bin` directory, run:

```
devbra -dev
```

In the output of the `devbra` command, you should find the newly connected tape drive and the robotics of the HP StorageWorks 12000e Library device.

What's next?

After properly connecting the library device, see the online Help index: “configuring, backup devices” for instructions about configuring a Data Protector backup device for your newly connected device.

Connecting an HP StorageWorks DLT Library 28/48-Slot

The HP StorageWorks DLT Library 28/48-Slot is a multi-drive library for enterprise environments with 80-600 GB to back up. It has four DLT 4000 or DLT 7000 drives with multiple data channels, a mail slot, and a barcode reader.

Connecting to an HP-UX system

Follow the steps below to connect the HP StorageWorks DLT Library 28/48-Slot library device to an HP-UX system:

1. Check that the required drivers (`stape` or `tape2`) drivers are *installed* and *built* into the current kernel. See [“Checking the kernel configuration on HP-UX”](#) on page 94.
2. Check that the required SCSI Pass-Through drivers (`sctl` or `spt`) are *installed* and *built* into the current kernel. See [“SCSI robotics configuration on HP-UX”](#) on page 408.
3. Determine an unused SCSI address that can be used by the tape drive and the robotics. See [“Finding the unused SCSI addresses on HP-UX”](#) on page 415.



NOTE:

The HP StorageWorks DLT Library 28/48-Slot has four tape drives and the robotics, so you need five unused SCSI addresses in case you will be using all tape drives. The tape drives and the robotics must use different SCSI addresses.

4. Set the SCSI addresses (IDs) on the device. For details, see the documentation that comes with the device.
5. Switch on the device, and then the computer, and wait until the boot process completes.
6. Verify that the system correctly recognizes the newly connected tape drives. Use the `ioscan` utility

```
/usr/sbin/ioscan -fn
```

to display a list of connected devices with the corresponding hardware paths and device files, where you must find your newly connected tape drives, having the correct SCSI addresses.

7. The device files for the drives have been created during the boot process, while the device file for the robotics must be created manually. See [“Creating device files on HP-UX”](#) on page 412.
8. Verify that the system correctly recognizes the newly created device file for the library robotics. Use the `ioscan` utility:

```
/usr/sbin/ioscan -fn
```

You should see your newly created device file in the output of the command.

What's next?

After properly connecting the HP StorageWorks DLT Library 28/48-Slot library device, see the online Help index: "configuring, backup devices" for instructions about configuring a Data Protector backup device for your newly connected device.

Connecting to a Solaris system

To configure the HP C5173-7000 library device on a Solaris system, follow the steps below. For this example, it is assumed that two drives are to be allocated to Data Protector:

1. Copy the `sst` driver (module) and configuration file `sst.conf` to the required directory:

- For 32-bit operating systems:

```
$cp /opt/omni/spt/sst /usr/kernel/drv/sst
$cp /opt/omni/spt/sst.conf /usr/kernel/drv/sst.conf
```

- For 64-bit operating systems:

```
$cp /opt/omni/spt/sst.64 /usr/kernel/drv/sparcv9 /sst
$cp /opt/omni/spt/sst.conf /usr/kernel/drv
/sparcv9/sst.conf
```

2. Add the driver to the Solaris kernel:

```
add_drv sst
```

3. Remove all existing device files from the `/dev/rmt` directory:

```
cd /dev/rmt rm *
```

4. Stop the system by pressing **Stop** and **A**.

5. Run the `probe-scsi-all` command at the "ok" prompt to check which SCSI addresses are available for use.

```
ok probe-scsi-all
```

The system may ask you to start the `reset-all` command before executing the `probe-scsi-all` command.

In our case, we will use port 6 for the SCSI control device, port 2 for the first drive, and port 1 for the second drive; lun is 0)

6. Return to normal running:

```
ok go
```

7. Copy the `st.conf` configuration file into the required directory:

```
$cp /opt/omni/spt/st.conf /kernel/drv/st.conf
```

The `st.conf` file is present on each Solaris Data Protector client and contains SCSI addresses for each backup device connected to the client.

8. Edit the `/kernel/drv/st.conf` file and add the following lines:

```
tape-config-list= "QUANTUM DLT7000", "Digital DLT7000",  
"DLT-data3";
```

```
DLT-data3 = 1,0x77,0,0x8639,4,0x82,0x83,0x84,0x85,3;
```

```
name="st" class="scsi"
```

```
target=1 lun=0;
```

```
name="st" class="scsi"
```

```
target=2 lun=0;
```

```
name="st" class="scsi"
```

```
target=6 lun=0;
```

These entries provide the SCSI addresses for drive 1, drive 2, and the robotic drive, respectively.

9. Edit the `sst.conf` file (that you copied across in step [Step 1](#) on page 433 and add the following line:

```
name="sst" class="scsi" target=6 lun=0;
```

 **NOTE:**

This entry must match that for the robotic drive in the `st.conf` file. See step [Step 8](#) on page 434 above.

10. Power down the client system and attach the library device.

11. Power up the library device first and then the client system.

The system will now boot and automatically create device files for the robotic drive and tape drives. These can be listed using the command `ls -all`. In our case:

`/dev/rmt/0hb` for a first tape drive

`/dev/rmt/1hb` for a second tape drive

`/dev/rsst6` for a robotic drive

What's next?

After properly connecting the HP StorageWorks DLT Library 28/48-Slot library device, see the online Help index: "configuring, backup devices" for instructions about configuring a Data Protector backup device for your newly connected device.

Connecting to a Windows system

Follow the steps below to connect the HP StorageWorks DLT 28/48-Slot library device to a Windows system:

1. Determine the unused SCSI addresses (Target IDs) that can be used by the tape drive and by the robotics. See ["Finding unused SCSI target IDs on a Windows system"](#) on page 422.
2. Set the SCSI addresses (Target IDs) on the device. For details, see the documentation that comes with the device.

 **NOTE:**

The HP StorageWorks DLT Library 28/48-Slot has four tape drives and the robotics, so you need five unused SCSI addresses in case you will be using all tape drives. The tape drives and the robotics must use different SCSI Target IDs.

3. First, switch on the device, then the computer, and then wait until the boot process completes.

4. Verify that the system correctly recognizes the newly connected tape drives and the robotics. In the `Data_Protector_home\bin` directory, run:

```
devbra -dev
```

In the output of the `devbra` command, you should find the newly connected tape drives and the robotics of the HP StorageWorks DLT Library 28/48-Slot library device.

What's next?

After properly connecting the HP StorageWorks DLT Library 28/48-Slot library device, see the online Help index: "configuring, backup devices" for instructions about configuring a Data Protector backup device for your newly connected library device.

Connecting a Seagate Viper 200 LTO Ultrium Tape Drive

The Seagate Viper 200 LTO Ultrium Tape Drive is a standalone device for enterprise environments with 100-200 GB to back up.

Connecting to a Solaris system

To configure the Seagate Viper 200 LTO Ultrium Tape Drive on a Solaris system, follow the steps below:

1. Determine the unused SCSI addresses that can be used by the tape drive. Run the `modinfo` or `dmesg` command to find the SCSI controllers in use and the SCSI target devices installed:

```
dmesg | egrep "target" | sort | uniq
```

The following output should be received:

```
sd32 at ithps0: target 2 lun 0
sd34 at ithps0: target 4 lun 0
st21 at ithps1: target 0 lun 0
st22 at ithps1: target 1 lun 0
```

 **NOTE:**

It is recommended that you use either a `glm` or `isp` SCSI controller when connecting the Viper 200 LTO device to a Solaris system. It is also recommended that you use either Ultra2 SCSI or Ultra3 SCSI controllers.

2. Edit the `/kernel/drv/st.conf` file and add the following lines:

```
tape-config-list=
"SEAGATE_ULTRIUM06242-XXX" , "SEAGATE_LTO" , \
"SEAGATE_LTO";
SEAGATE_LTO = 1, 0x7a, 0, 0x1d679, 4, 0x00, 0x00, 0x00, \
0x00, 1;
```

3. Power down the client system and attach the device.
4. Power up the device first and then the client system.

The system will now boot and automatically create device files for the tape drive. These can be listed using the command `ls -all`.

What's next?

After properly connecting the Seagate Viper 200 LTO Ultrium Tape Drive, see the online Help index: "configuring, backup devices" for instructions about configuring a Data Protector backup device for your newly connected device.

Connecting to a Windows system

Follow the steps below to connect the Seagate Viper 200 LTO Ultrium Tape Drive to a Windows system:

1. Determine the unused SCSI addresses (Target IDs) that can be used by the tape drive. See “[Finding unused SCSI target IDs on a Windows system](#)” on page 422.
2. Set the SCSI addresses (Target IDs) on the device. For details, see the documentation that comes with the device.
1. First, switch on the device, then the computer, and then wait until the boot process completes.
2. Verify that the system correctly recognizes the newly connected tape drives and the robotics. In the `Data_Protector_home\bin` directory, run:

```
devbra -dev
```

In the output of the `devbra` command, you should find the newly connected tape drive of the Seagate Viper 200 LTO Ultrium Tape Drive.

What's next?

After properly connecting the Seagate Viper 200 LTO Ultrium Tape Drive, see the online Help index: “[configuring, backup devices](#)” for instructions about configuring a Data Protector backup device for your newly connected device.

NOTE:

When configuring the Seagate Viper 200 LTO Ultrium Tape Drive with Data Protector, make sure that the compression mode is set. This is done by specifying the `C` parameter after the SCSI address of the drive, for example:

```
scsi2:0:0:0C
```

Checking the General Media Agent Installation on Novell NetWare

After you have installed the General Media Agent on the Novell NetWare platform, you should verify the installation by performing the following tasks:

- Identify the storage device.
- Test the General Media Agent startup at the Novell NetWare server's console.

- Test `HPUMA.NLM` and `HPDEVBRA.NLM` startup at the Novell NetWare server's console.

Identifying the storage device

Use the following convention to identify a storage device in the Novell NetWare environment:

*adapter identification number:target identification number:
logical unit numbercompression*

For example, string "0:2:0N" identifies a storage device as adapter ID 0, target ID 2, a logical unit number (LUN) 0, and no compression.

Another example is string "1:1:0C" that identifies a storage device as adapter ID 1, target ID 1, a Logical Unit Number (LUN) 0, with compression.

Testing the general Media Agent startup

Once you have the General Media Agent installed on the Novell NetWare system, you can test a startup of a backup Media Agent `HPBMA.NLM` at the Novell NetWare server's console.

The example below uses the Adaptec host bus adapter, `AHA-2940`, to access the exchanger tape device of the HP StorageWorks Tape 12000e library device.

The following conditions should be fulfilled before you start any of the Data Protector *.NLM components:

- `HPINET` must be up and running.
- The Adaptec SCSI host adapter driver must be up and running.
- The General Media Agent software must be located in the `SYS:USR\OMNI\BIN` directory.
- The storage device must be correctly installed and connected.
- The Adaptec host bus adapter and the TCP/IP communication protocol must be properly installed, and up and running.

Once the required conditions have been verified, proceed as follows:

1. Enter the following to load HPBMA.NLM:

```
LOAD HPBMA -name testbma -type type_number -policy  
policy_number -ioctl control_device -dev data_device -tty  
tty_number
```

The *type type_number* option is the Data Protector device type. Possible values for *type_number* are:

- 1=DAT/DDS
- 2 = Quarter Inch Cartridge(QIC)
- 3 = 8mm - Exabyte
- 9 = Generic Magnetic tape device
- 10 = Digital Linear Tape (DLT)

The *policy policy_number* option is the Data Protector way to use the device. Possible values are:

- 1= standalone device
- 10= SCSI - II library

The *ioctl control_device* option defines the SCSI address of the robotics control. It has the following form:

```
adapter_identification_number:target_identification_number:logical_unit_number
```

For example:

- 0:1:1 =>The control device (robotics) uses the SCSI adapter 0, has the SCSI address 1, and has the LUN 1.

The *dev data_device* option defines the SCSI address of the robotics control. It has the following form:

```
adapter_identification_number:target_identification_number:logical_unit_number:compression
```

For example:

- 0:1:1C =>The control device (robotics) is uses SCSI adapter 0, has the SCSI address 1, and has the LUN 1. The data compression has been set.

The *-tty tty_number* is the TCP/IP communication protocol port number.

The Console Media Agent, HPCONMA.NLM, starts and you will be prompted by the following screen:

```
*** MA listening on port: number
```

```
SLOT: [Load(2), Peek(2), Stop(0), Abort(0)]
```

SLOT: _

The currently available commands are:

Load(2) – The command is used for loading the tape into the drive and requires two arguments:

Load Slot numberflipping flag

The flipping flag can be set either to 0 or to 1, meaning that the medium does not flip if the value is 0 or it flips if the value is 1.

Stop(0) – Completes the current session normally.

Abort(0) – Aborts the current session.

In this example, you will load the tape from SLOT 3 with no flipping of the medium.

2. Enter the command to load the tape from SLOT 3 with no flipping of the medium.

```
SLOT:LOAD 3 0
```

Once the tape is loaded in the drive, the following message will be displayed:

```
CHECK: [Deny(0), Init(1), Seek(2), Abort(0)]
```

```
CHECK: _
```

The available commands are:

Deny(0) – Denies the current action.

Init(1) – Initializes the loaded tape and requires one parameter:

Init(1) medium_id

Seek(2) – Seeks to the requested position. The argument string is:

Seek segment_numberblock number

Abort(0) – Aborts the current session.

3. To initialize the tape, enter

```
CHECK: Init test
```

4. Switch from Backup Media Agent screen to the Novell NetWare console and start the backup session using the General Media Agent action/request command.



NOTE:

The Data Protector Disk Agent should be started at the selected host using `load -ma host port` to enable proper General Media Agent and Disk Agent communication and to display the correct backup session operations port number as the `HPCONMA.NLM` starts. A message will appear after the successful backup session.

5. To successfully terminate the Backup Media Agent, press **CTRL-C** at the Backup Media Agent screen. The Console Attention Request prompt appears after a short time-out:

```
ATT:[Stop(0), Abort(0), Disconnect(1)] Run Stop to successfully
complete the session.
```

Testing the HPUMA.NLM and the HPDEVBRA.NLM startup

Loading `HPUMA.NLM` at the server's console allows you to test the SCSI commands manually.

Load `HPUMA.NLM` with the following command:

```
LOAD HPUMA.NLM -ioctl control_device -dev data_device
-tty
```

The `ioctl control_device` option defines the SCSI address of the robotics control. It has the following form:

```
adapter_identification_number:target_identification_number.logical_unit_number
```

For example:

- `0:1:1` =>The control device (robotics) uses the SCSI adapter 0, has the SCSI address 1, and uses the LUN 1.

The `dev data_device` option defines the SCSI address of the robotics control. It has the form:

```
adapter_identification_number:target_identification_number.logical_unit_number:compression
```

For example:

- 0:1:1C =>The control device (robotics) uses SCSI adapter 0, has the SCSI address 1, and uses the LUN 1. The data compression has been set.

The `-tty` option is necessary to interact with the Novell NetWare server's console.

The HPUMA starts and you are prompted with the following screen:

```
prompt
```

where prompt has the following form:

```
adapter_identification_number:target_identification_
number:logical_unit_number For example,
```

```
0:2:1
```

To see the available commands, type `HELP` in the HPUMA screen. For example, to see which slots and drive(s) are full or empty, type `STAT` at the prompt.

When you have finished, type `BYE` to close the HPUMA screen.

Loading `HPDEVBRA.NLM` locally enables you to get information on the devices both installed and detected on the Novell NetWare server.

To load `HPDEVBRA.NLM` at the server console, enter the following command:

```
LOAD HPDEVBRA.NLM -dev
```

where the `-dev` option is necessary to list all devices attached onto the Novell NetWare server.

To see the currently available commands, load `HPDEVBRA.NLM` with `HELP` option:

```
LOAD HPDEVBRA -HELP
```

Installing Data Protector on Microsoft Cluster with Veritas Volume Manager

To install Data Protector on Microsoft Cluster Server (MSCS) with Veritas Volume Manager, first follow the general procedure for installation of Data Protector on MSCS. See "[Installing Data Protector on Microsoft Cluster Server](#)" on page 191.

After you have completed the installation, some additional steps are required to enable the `Data Protector Inet` service to differentiate between local and cluster disk resources which use their own resource driver and not the Microsoft resource driver:

1. Run the `omnisv -stop` command on the Cell Manager to stop the Data Protector services/processes: `Data_Protector_home\bin\omnisv -stop`

2. Define a new system environment variable

OB2CLUSTERDISKTYPES with Volume Manager Disk Group as a value, or set the `omnirc` variable on both cluster nodes as follows:

```
OB2CLUSTERDISKTYPES=Volume Manager Disk Group
```

If you want to specify additional proprietary disk resources, such as NetRAID4 disk, simply append the resource type name to the

OB2CLUSTERDISKTYPES environment variable value:

```
OB2CLUSTERDISKTYPES=Volume Manager Disk Group;NETRaid4M  
Diskset
```

For more information on using the `omnirc` file variables, see the *HP Data Protector troubleshooting guide*.

3. Run the `omnisv -start` command to start the

services/processes:`Data_Protector_home\bin\omnisv -start`

Configuration files path changes in Data Protector A.06.10

The default paths of some configuration, log and (on UNIX) database files has been changed in Data Protector A.06.10. Some of the files are now split in the `server` and `client` directory.

Check the following tables for the changes and modify the paths, if necessary.

Configuration files on UNIX

Client configuration files

The following table represents the files and directory that are moved from the `/etc/opt/omni` to the `/etc/opt/omni/client` directory during the upgrade.

Table 30 The content of the new `/etc/opt/omni/client` directory

Old Path	Current Path
<code>/etc/opt/omni/cell/cell_server</code>	<code>/etc/opt/omni/client/cell_server</code>
<code>/etc/opt/omni/cell/omni_format</code>	<code>/etc/opt/omni/client/omni_format</code>

Old Path	Current Path
/etc/opt/omni/cell/omni_info	/etc/opt/omni/client/omni_info
/etc/opt/omni/cell/allow_hosts	/etc/opt/omni/client/allow_hosts
/etc/opt/omni/cell/deny_hosts	/etc/opt/omni/client/deny_hosts
/etc/opt/omni/customize	/etc/opt/omni/client/customize

Cell Manager configuration and log files

The rest of the content of the `/etc/opt/omni` directory is moved to the `/etc/opt/omni/server` directory. For example, the `/etc/opt/omni/cell/cell_info` file is now located in the `/etc/opt/omni/server/cell` directory.

The following table represents the files and directories that are moved from the `/var/opt/omni` directory to the `/var/opt/omni/server` directory during the upgrade.

Table 31 The content of the new `/var/opt/omni/server` directory

Old Path	Current Path
/var/opt/omni/db40	/var/opt/omni/server/db40
/var/opt/omni/sessions	/var/opt/omni/server/sessions
/var/opt/omni/log/log_file	/var/opt/omni/server/log/log_file

where `log_file` represents any of the following files: `HealthCheck.log`, `Check_*.txt`, `Ob2Event*`, `lic.log`, `omnisv.log`, `media.log`, `sm.log`, `crsevents.log`, `security.log`, `purge.log`, `readascii.log`, `cleaning.log`, `upgrade.log`, `trace.log`, and `cluster.log`.

All other directories (for example, `/var/opt/omni/tmp`, `/var/opt/omni/windu`, or `/var/opt/omni/emc`) and log files (for example, `/var/opt/omni/log/debug.log`) are not moved.

Configuration files on Windows

Client configuration files

The following table represents the files and directories that are moved from the *Data_Protector_home\Config* directory to the *Data_Protector_home\Config\client* and the *Data_Protector_home\tmp* directories during the upgrade.

Table 32 The content of the new *Data_Protector_home\Config\client* directory

Old Path	Current Path
<i>Data_Protector_home\Config\cell\cell_server</i>	<i>Data_Protector_home\Config\client\cell_server</i>
<i>Data_Protector_home\Config\cell\ami_format</i>	<i>Data_Protector_home\Config\client\ami_format</i>
<i>Data_Protector_home\Config\cell\ami_info</i>	<i>Data_Protector_home\Config\client\ami_info</i>
<i>Data_Protector_home\Config\cell\allow_hosts</i>	<i>Data_Protector_home\Config\client\allow_hosts</i>
<i>Data_Protector_home\Config\cell\deny_hosts</i>	<i>Data_Protector_home\Config\client\deny_hosts</i>
<i>Data_Protector_home\Config\EMC</i>	<i>Data_Protector_home\Config\client\EMC</i>
<i>Data_Protector_home\Config\tmp\EMC</i>	<i>Data_Protector_home\tmp\EMC</i>

Cell Manager configuration files

The rest of the content of the *Data_Protector_home\Config* directory is moved to the *Data_Protector_home\Config\Server* directory. For example, the *Data_Protector_home\Config\cell\cell_info* file is now located in the *Data_Protector_home\Config\Server\cell* directory.

Log files

The following files are moved from the *Data_Protector_home\log* directory to the *Data_Protector_home\log\server* directory: *HealthCheck.log*, *Check_*.txt*, *Ob2Event**, *lic.log*, *omnisv.log*, *media.log*, *sm.log*, *crsevents.log*, *security.log*, *purge.log*, *readascii.log*, *cleaning.log*, *upgrade.log*, *trace.log*, and *cluster.log*.

All other log files (for example, *Data_Protector_home\log\debug.log*) are not moved.

Command line changes after upgrading to Data Protector A.06.10

The commands listed in this chapter have been changed or provide extended functionality in terms of new options in Data Protector A.06.10. Check and modify the scripts that use the old commands. For usage synopses, see the HP Data Protector command line interface reference or the corresponding man pages.

Depending on the version from which you upgraded your Cell Manager, refer to the corresponding table:

- After upgrading from Data Protector A.05.10, see [Table 33](#) on page 447.
- After upgrading from Data Protector A.05.50, see [Table 34](#) on page 455.
- After upgrading from Data Protector A.06.00, see [Table 35](#) on page 460.
- After upgrading from Application Recovery Manager A.06.00, see [Table 36](#) on page 464.

Table 33 Upgrade from Data Protector A.05.10

Command	Subcommand/Option	Status
ob2install	sapdb	NEW SOFTWARE COMPONENTS
	smisa	
	sps	
	vmware	
	acs	OBSOLETE SOFTWARE COMPONENTS
	das	
	momgui	
omnib	-sapdb_list	NEW INTEGRATION
	-mssps_list	

Command	Subcommand/Option	Status
	-vmware_list	
	-vss_list	OBSOLETED OPTION
	-msvssw_list	NEW OPTIONS
	-share_info	
	-mirror	
	-enh_incr	
	-async	
	-encode aes256	
omnicc	-check_licenses	NEW OPTIONS
	-detail	
	-update_all	
	-force_cs	
	-list_trusted_hosts	
	-secure_client	
	-unsecure_client	
	-trusted_hosts	
omniclus	-applid	CHANGED OPTION
omnicreated1	-smis	NEW OPTIONS FOR HP
	-instant_recovery	

Command	Subcommand/Option	Status
	-snapshots <i>number</i>	StorageWorks ENTERPRISE VIRTUAL ARRAY
	-snapshot_type clone	
	-wait_clonecopy <i>number</i>	
	-replica_conf local	
	-replica_conf combined	
	-ca_failover_option follow_replica_direction	
	-ca_faiover_option maintain_replica_location	
omnidb	-sapdb	NEW INTEGRATION
	-mssps	
	-vmware	
	-copyid	NEW OPTIONS
	-listcopies	
	-auditing	
	-timeframe	
omnidbcheck	-keystore	NEW OPTIONS
	-summary	
omnidbeva		OBSOLETE COMMAND
omnidbrestore	-keyfile	NEW OPTION

Command	Subcommand/Option	Status
omidbupgrade		NEW COMMAND
omnidbvss		NEW COMMAND
omnidbutil	-extendtblspace	NEW OPTIONS
	-free_cell_resources	
	-list_large_directories	
	-list_large_mpos	
	-list_mpos_without_overs	
	-readdb	CHANGED OPTION
omnidlc		NEW COMMAND
omnikeymigrate		NEW COMMAND
omnikeytool		NEW COMMAND
omnimigrate.pl		NEW COMMAND
omnimit	-[no]barcode_as_label	NEW OPTION
omnimm	-[no_]free_pool	CHANGED OPTION
	-create_free_pool	NEW OPTION
omniinstlic		NEW COMMAND
omniiso		NEW COMMAND
omniobjcopy		NEW COMMAND
omniobjconsoli		NEW COMMAND

Command	Subcommand/Option	Status
date		
omnir	-sapdb	NEW INTEGRATION
	-mssps	
	-vmware	
	-newinstance	NEW OPTIONS FOR SAP DB
	-recover	
	-endlogs	
	-time	
	-nochain	
	-destination	
	-from_disk	
	-instance	NEW OPTIONS FOR MS SPS
	-portal	
	-ssodb	
	-doclib	
	-tohost	
	-instance	
	-as	
	-todir	
-changemaster		

Command	Subcommand/Option	Status	
	-force_prp_replica	NEW OPTION FOR HP StorageWorks ENTERPRISE VIRTUAL ARRAY	
	-instance <i>SourceInstanceName</i>	NEW OPTIONS FOR MS SQL	
	-destinstance <i>DestinationInstanceName</i>		
	-asbase <i>NewDBName</i>		
	-file <i>LogicalFileName</i>		
	-oracle	NEW OPTIONS FOR ORACLE AND SAP R/3 INSTANT RECOVERY	
	-sap		
	-user		
	-group		
	-recover		
	-open		
	-resetlogs		
	-paralleism		
	-public		NEW OPTIONS FOR MS EXCHANGE SINGLE MAILBOX
	-originalfolder		
	-keep_msg		
	-overwrite_msg		
	-folder		

Command	Subcommand/Option	Status
	-exclude	
	-restore	NEW OPTIONS FOR VSS INSTANT RECOVERY
	-session	
	-vss	
	-use_vds	
	-delete_replica	
	-delete_current	
	-exch_throttle	
	-conf_check	
	-[no_]copy_back	
	-copyid	
	-no_auto_dev	
	-omit_unrequired_object_versions	
	-omit_unrequired_incrementals	OBSOLETE OPTION Replaced by -omit_unrequired _object_versions.
omnirpt	-smtp	NEW OPTIONS
	-copylist_sch	
	-copylist_post	
	-no_copylist	

Command	Subcommand/Option	Status
	-conslist_sch	
	-conslist_post	
	-no_conslist	
	-num_copies	
	obj_copies	NEW REPORTS
	session_objcopies	
	session_errors	
	session_statistics	OBSOLETE REPORTS
	backup_errors	
		backup_statistics
omniresolve		NEW COMMAND
omnisetup.sh	-CM	NEW OPTIONS
	-IS	
	-autopass	
	smisa	NEW SOFTWARE COMPONENTS
	sapdb	
	docs	
	javagui	
	vmware	

Command	Subcommand/Option	Status
	acs	OBSOLETE SOFTWARE COMPONENTS
	das	
	momgui	
omniusers		NEW COMMAND
sanconf	-[no_]multipath	NEW OPTIONS
	-remove_hosts	
	-sanstableaddressing	
upgrade_cm_ from_evaa		NEW COMMAND
winomnimigrate.pl		NEW COMMAND

Table 34 Upgrade from Data Protector A.05.50

Command	Subcommand/Option	Status
ob2install	sps	NEW SOFTWARE COMPONENT
	vmware	
	momgui	OBSOLETE SOFTWARE COMPONENT
omnib	-mssps_list	NEW INTEGRATION
	-vmware_list	
	-enh_incr	NEW OPTIONS
	-async	
	-encode aes256	

Command	Subcommand/Option	Status
omnidb	-mssps	NEW INTEGRATION
	-vmware	
	-auditing	NEW OPTIONS
	-timeframe	
omnidbcheck	-keystore	NEW OPTIONS
	-summary	
omnidbsmis	-ssl	NEW OPTIONS
	-caconf	
	-init	
	-put <i>filename</i>	
	-get <i>filename</i>	
	-list <i>EVA Name</i>	
	-check <i>DR Group Name</i>	
omnidbeva		OBSOLETE COMMAND
omnicreated1	-replica_conf local	NEW OPTIONS FOR HP StorageWorks ENTERPRISE VIRTUAL ARRAY
	-replica_conf combined	
	-ca_failover_option follow_replica_direction	
	-ca_faiover_option maintain_replica_location	
omnidbrestore	-keyfile	NEW OPTION

Command	Subcommand/Option	Status
omnidbutil	-extendtblspace	NEW OPTIONS
	-free_cell_resources	
	-list_large_directories	
	-list_large_mpos	
	-list_mpos_without_overs	
	-readdb	CHANGED OPTION
omnidbvss		NEW COMMAND
omnidlc	-debug_loc	NEW OPTION
omnikeymigrate		NEW COMMAND
omnikeytool		NEW COMMAND
omnimigrate.pl		UPDATED COMMAND
omnimm	-[no_]free_pool	CHANGED OPTION
	-create_free_pool	NEW OPTION
omniobjcopy	-mssps	NEW INTEGRATION
omniobjconsolidate		NEW COMMAND
omnir	-mssps	NEW INTEGRATION
	-vmware	
	-portal	NEW OPTIONS FOR MS SPS
	-ssodb	

Command	Subcommand/Option	Status
	-doclib	
	-tohost	
	-instance	
	-as	
	-todir	
	-changemaster	
	-public	NEW OPTIONS FOR MS EXCHANGE SINGLE MAILBOX
	-originalfolder	
	-keep_msg	
	-overwrite_msg	
	-folder	
	-exclude	
	-restore	NEW OPTIONS FOR VSS INSTANT RECOVERY
	-session	
	-vss	
	-use_vds	
	-delete_replica	
	-delete_current	
	-exch_throttle	
	-conf_check	

Command	Subcommand/Option	Status
	-[no_]copy_back	
	-no_auto_dev	NEW OPTIONS
	-omit_unrequired_object_versions	
	-omit_unrequired_incrementals	OBSOLETE OPTION Replaced by -omit_unrequired _object_versions.
omnirpt	-smtp	NEW OPTIONS
	-copylist_sch	
	-copylist_post	
	-no_copylist	
	-conslist_sch	
	-conslist_post	
	-no_conslist	
	-num_copies	
	obj_copies	NEW REPORTS
	session_objcopies	
	session_errors	
	session_statistics	
	backup_errors	OBSOLETE REPORTS
	backup_statistics	

Command	Subcommand/Option	Status
omnisetup.sh	docs	NEW SOFTWARE COMPONENTS
	javagui	
	vmware	
	momgui	OBSOLETE SOFTWARE COMPONENT
upgrade_cm_from_evaa		NEW COMMAND
upgrade_cfg_from_evaa		OBSOLETE COMMAND
winomnigrate.pl		NEW COMMAND

Table 35 Upgrade from Data Protector A.06.00

Command	Subcommand/Option	Status
ob2install	vmware	NEW SOFTWARE COMPONENT
	momgui	OBSOLETE SOFTWARE COMPONENT
omnib	-vmware_list	NEW INTEGRATION
	-async	NEW OPTIONS
	-encode aes256	
omnidb	-vmware	NEW INTEGRATION
	-auditing	NEW OPTIONS

Command	Subcommand/Option	Status
	-timeframe	
omnidbcheck	-keystore	NEW OPTIONS
	-summary	
omnidbvss	-init -list session -list disk -get session -get disk -remove session -remove disk	NEW OPTIONS
	-get table -list table -remove table	OBSOLETE OPTIONS
omnidbrestore	-keyfile	NEW OPTION
omnidbutil	-free_cell_resources	NEW OPTIONS
	-list_large_directories	
	-list_large_mpos	
	-list_mpos_without_overs	
omnikeymigrate		NEW COMMAND
omnikeytool		NEW COMMAND
omniinetpasswd	-add	NEW COMMAND
	-delete	
	-list	

Command	Subcommand/Option	Status
	-modify	
	-help	
	-version	
	-clean	
	-inst_srv_user [no]	
	-no_inst_srv_user [no]	
omnir	-vmware	NEW INTEGRATION
	-no_auto_dev	NEW OPTIONS
	-omit_unrequired_object_versions	
	-omit_unrequired_incrementals	OBSOLETE OPTION Replaced by -omit_unrequired _object_versions.
	-use_vds	NEW OPTIONS FOR VSS IR
	-delete_replica	
	-delete_current	
	-exch_throttle	
	-conf_check	
	-[no]_copy_back	
-winfs		

Command	Subcommand/Option	Status
omnirpt	-copylist_sch	NEW OPTIONS
	-copylist_post	
	-conslist_sch	
	-conslist_post	
	-num_copies	
	-copylist	OBSOLETED OPTIONS
	-conslist	
	obj_copies	NEW REPORTS
	session_objcopies	
	session_errors	
	session_statistics	
	backup_errors	OBSOLETED REPORTS
	backup_statistics	
omnisetup.sh	docs	NEW SOFTWARE COMPONENTS
	javagui	
	vmware	

Command	Subcommand/Option	Status
	momgui	OBSOLETE SOFTWARE COMPONENT

Table 36 Upgrade from Application Recovery Manager A.06.00

Command	Subcommand/Option	Status
omnib	-disk_only	NEW OPTION
dbtool.pl		OBSOLETE COMMAND Replaced by the internal database backup.
<p>NOTE: The first part of the table lists only changes to commands already available in Application Recovery Manager A.06.00 and which may affect your scripts. <i>All commands introduced with Data Protector</i> are listed below as "NEW".</p>		
NNMpost		NEW COMMAND
NNMpre		NEW COMMAND
NNMscript		NEW COMMAND
ob2install		NEW COMMAND
omniamo		NEW COMMAND
omnicreated1		NEW COMMAND
omnidbrestore		NEW COMMAND
omnidbupgrade		NEW COMMAND
omnidbva		NEW COMMAND

Command	Subcommand/Option	Status
omnidbxp		NEW COMMAND
omnidownload		NEW COMMAND
omnidr		NEW COMMAND
omniiso		NEW COMMAND
omnimcopy		NEW COMMAND
omnimigrate.pl		NEW COMMAND
omniminit		NEW COMMAND
omnimlist		NEW COMMAND
omnimm		NEW COMMAND
omnimnt		NEW COMMAND
omnimver		NEW COMMAND
omniobjcopy		NEW COMMAND
omniobjconsolidate		NEW COMMAND
omniofflr		NEW COMMAND
omniresolve		NEW COMMAND
omnirpt		NEW COMMAND
omnisetup.sh		NEW COMMAND
omnisrdupdate		NEW COMMAND
omnistat		NEW COMMAND
omniupload		NEW COMMAND

Command	Subcommand/Option	Status
sanconf		NEW COMMAND
syb_tool		NEW COMMAND
uma		NEW COMMAND
upgrade_cn_from_evaa		NEW COMMAND
util_cmd		NEW COMMAND
util_oracle8.pl		NEW COMMAND

C Appendix C

Using CD-ROMs as the installation media

Data Protector A.06.10 is also available on installation CD-ROMs. All system requirements, pre-installation and post-installation tasks are the same as with the installation from the DVD-ROM media. However, the installation procedures for the HP-UX, Solaris, or Linux platforms require additional steps as you need several CD-ROMs for one platform.

This appendix includes the product structure on the installation CD-ROMs, the differences in the installation procedures and additional limitations that apply to the installation from the CD-ROMs.

Data Protector installation CD-ROMs

Data Protector supports various operating systems on several processor architectures. As a consequence, 15 CD-ROMs are required to cover all platforms. For details which components are found on which CD-ROM, refer to [Table 37](#) on page 467.

A particular CD-ROM for the HP-UX, Solaris, or Linux platform is referenced to in the documentation depending on the Data Protector component which is installed from it, that is: **Cell Manager installation CD-ROM** for the CD-ROM that is used for installing the Cell Manager and **Installation Server installation CD-ROM** for the CD-ROM that holds the Installation Server and the clients.

Table 37 Data Protector CD-ROM list

CD Num.	CD-ROM Title	Contents
1	HP Data Protector for HP-UX PA-RISC - Cell Manager	<ul style="list-style-type: none">• Cell Manager for HP-UX 11.x (PA-RISC architecture)• All English manuals in PDF format (in the <code>DOCS</code> directory)

CD Num.	CD-ROM Title	Contents
	<i>Referenced to Data Protector HP-UX Cell Manager installation CD-ROM.</i>	<ul style="list-style-type: none"> • OpenView Integration Packages for HP-UX • AutoPass for HP-UX • <code>Omnisetup.sh</code> installation script
2	HP Data Protector for HP-UX PA-RISC - Installation Server	<ul style="list-style-type: none"> • Installation Server for HP-UX 11.x (PA-RISC architecture) including all UNIX clients • <code>Omnisetup.sh</code> installation script
3	<i>Referenced to Data Protector HP-UX Installation Server installation CD-ROM 1 and 2.</i>	
4	HP Data Protector for HP-UX IA-64 - Cell Manager <i>Referenced to HP-UX Cell Manager installation CD-ROM.</i>	<ul style="list-style-type: none"> • Cell Manager for HP-UX 11.23 (IA-64 architecture) • <code>DOCS</code> directory containing all English manuals in PDF format • OpenView Integration Packages for HP-UX • AutoPass for HP-UX • <code>Omnisetup.sh</code> installation script
5	HP Data Protector for HP-UX IA-64 - Installation Server	<ul style="list-style-type: none"> • Installation Server for HP-UX 11.23 (IA-64 architecture) including all UNIX clients • <code>Omnisetup.sh</code> installation script
6	<i>Referenced to Data Protector HP-UX Installation Server installation CD-ROM 1 and 2.</i>	
7	HP Data Protector for Solaris- Cell Manager <i>Referenced to Data Protector Solaris Installation Server installation CD-ROM.</i>	<ul style="list-style-type: none"> • Cell Manager for Solaris 8/9/10 • All English manuals in PDF format (in the <code>DOCS</code> directory) • OpenView Integration Packages for Solaris • AutoPass for Solaris • <code>Omnisetup.sh</code> installation script
8	HP Data Protector for Solaris - Installation Server	<ul style="list-style-type: none"> • Installation Server for Solaris 8/9/10 including all UNIX clients¹

CD Num.	CD-ROM Title	Contents
9	<i>Referenced to Data Protector Solaris Installation Server installation CD-ROM 1 and 2.</i>	<ul style="list-style-type: none"> • <code>Omnisetup.sh</code> installation script
10	HP Data Protector for Linux x86-64 - Cell Manager <i>Referenced to Data Protector Linux Cell Manager installation CD-ROM.</i>	<ul style="list-style-type: none"> • Cell Manager for Linux • All English manuals in PDF format (in the <code>Docs</code> directory) • <code>Omnisetup.sh</code> installation script
11	HP Data Protector for Linux x86-64 - Installation Server	<ul style="list-style-type: none"> • Installation Server for Linux including all UNIX clients¹ • <code>Omnisetup.sh</code> installation script
12	<i>Referenced to Data Protector Linux Installation Server installation CD-ROM 1 and 2.</i>	
13	Data Protector for Windows - Cell Manager & Installation Server. Includes agents for Netware clients <i>Referenced to Data Protector Windows installation CD-ROM.</i>	<ul style="list-style-type: none"> • Cell Manager for Windows • Installation Server for Windows • Novell NetWare clients • All English manuals in PDF format (in the <code>Docs</code> directory) • AutoPass for Windows • Product Demo for Windows platforms • Product information
14	HP Data Protector Integrations with OpenView; Open File Backup; and agents for OpenVMS, da& MPE clients.	<ul style="list-style-type: none"> • OpenView Integrations • Open File Manager installation package • OpenVMS clients • MPE clients • All English manuals in PDF format (in the <code>Docs</code> directory) • Product information

CD Num.	CD-ROM Title	Contents
15	HP Data Protector - Media Operations for Windows	<ul style="list-style-type: none"> • Installation package for Media Operations • Documentation for Media Operations

¹ Local installation of UNIX clients from the Solaris or Linux Installation Server installation CD-ROM is not possible. Instead, one of the HP-UX Installation Server CD-ROMs must be used.

Additional steps and tasks when installing Data Protector from CD-ROMs

The procedure for installing Data Protector from the CD-ROM is similar to the procedure for installing from DVD-ROM.

- **On UNIX**, the installation packages are split in to 3 CD-ROMs (one for the Cell Manager and two for the Installation Server); as a result you need to continue the installation from the additional CD-ROMs.
- **On Windows**, each platform is contained on 1 CD-ROM; as a result, the Windows installation procedure from the CD-ROM is identical to the installation from the DVD-ROMs, except for the changed installation paths:

32-bit OS (on x86 or AMD64/Intel EM64T): \i386\setup.exe

64-bit OS (on AMD64/Intel EM64T): \x8664\setup.exe

64-bit OS (on Itanium): \ia64\setup.exe (only for clients)

Installing the UNIX Cell Manager from CD-ROMs



TIP:

If you install the Cell Manager and Installation Server on the same system, you can perform the installation in one step by copying the DP_DEPOT directory to the disk and then running `omnisetup.sh -CM -IS1 -IS2`.

For a description of the `omnisetup.sh` command, refer to the `README` file located in the `Mount_point/LOCAL_INSTALL` directory on the CD-ROM or to the HP Data Protector command line interface reference located in the `Mount_point/DOCS/C/MAN` directory on the CD-ROM.

Follow the procedure below to install the Cell Manager on an HP-UX, Solaris, or Linux system:

1. Insert and mount the appropriate Cell Manager installation CD-ROM to a mountpoint.

For example:

```
mkdir /cdrom mount /dev/dsk/c0t0d0 /cdrom
```

Optionally, you can install Data Protector from a depot on the disk:

- To copy the `DP_DEPOT`, `LOCAL_INSTALL`, and `AUTOPASS` directories, where the installation files are stored, to your local disk, run:

```
mkdir directory cp -r /cdrom/DP_DEPOT directory cp -r /cdrom/LOCAL_INSTALL directory cp -r /cdrom/AUTOPASS directory
```

- To copy the whole CD-ROM to your local disk, run:

```
cp -r /cdrom cd_image_dir
```

2. Run the `omnisetup.sh` command.

To run this command from the CD-ROM, type:

```
cd /cdrom/LOCAL_INSTALL ./omnisetup.sh -CM
```

To start the installation from disk:

- If you have copied the `DP_DEPOT`, `LOCAL_INSTALL`, and `AUTOPASS` directories from the CD-ROM to your local disk under *directory*, go to the directory where the `omnisetup.sh` command is stored, and run:

```
cd directory/LOCAL_INSTALL ./omnisetup.sh -CM
```

- If you have copied the whole CD-ROM to *cd_image_dir*, run the `omnisetup.sh` command with the `-CM` parameter:

```
cd cd_image_dir/LOCAL_INSTALL ./omnisetup.sh -CM
```

3. **On HP-UX and Solaris**, `omnisetup.sh` prompts you to install or upgrade the HP OpenView AutoPass utility if you want to download and install passwords for the purchased licenses directly through the internet from the HP password delivery center web server. For more information on the AutoPass utility, refer to [“Obtaining and installing permanent passwords using the HP AutoPass utility”](#) on page 323. It is recommended to install AutoPass.

If AutoPass is installed on MC/ServiceGuard, it must be installed on all nodes.

When prompted, press **Return** to install or upgrade AutoPass. If you do not want to install or upgrade AutoPass, enter **n**.

On Linux, HP OpenView AutoPass is not installed.

 **NOTE:**

If you have installed the Cell Manager on Solaris 9 or Solaris 10, remotely install the Disk Agent on the Cell Manager using an Installation Server. This will replace the generic Solaris Disk Agent with the Solaris 9 or Solaris 10 Disk Agent. Refer to [“Remote installation of Data Protector clients”](#) on page 77 or to the `ob2install` man page.

Installing the UNIX Installation Server from CD-ROMs

The Installation Server for UNIX is packed on two installation CDs. Therefore, the installation procedure must be continued from the second Installation Server CD.

Follow the procedure below to install the Cell Manager on an HP-UX, Solaris, or Linux system:

1. Insert and mount the appropriate Installation Server installation CD-ROM to a mount point.

For example:

```
mkdir /cdrom mount /dev/dsk/c0t0d0 /cdrom
```

Optionally, you can install Data Protector from a depot on the disk:

- To copy the `DP_DEPOT`, and `LOCAL_INSTALL` directories, where the installation files are stored, to your local disk, run:

```
mkdir directory cp -r /cdrom/DP_DEPOT directory cp -r /cdrom/LOCAL_INSTALL directory
```

Mount the second Installation Server installation CD-ROM and copy all the files from the `DP_DEPOT` directory to the installation directory as well:

```
cp -r /cdrom/DP_DEPOT directory
```

- To copy the whole CD-ROM to your local disk, run:

```
cp -r /cdrom cd_image_dir
```

2. Run the `omnisetup.sh` command.

To run this command from the CD-ROM, type:

```
cd /cdrom/LOCAL_INSTALL ./omnisetup.sh -IS1
```

To start the installation from disk:

- If you have copied the `DP_DEPOT` and `LOCAL_INSTALL` directory from both CD-ROMs to your local disk under *directory*, go to the directory where the `omnisetup.sh` command is stored, and run:

```
cd directory/LOCAL_INSTALL ./omnisetup.sh -IS1 -IS2
```

- If you have copied the whole CD-ROM to `cd_image_dir`, run the `omnisetup.sh` command with the `-IS1` parameter:

```
cd cd_image_dir/LOCAL_INSTALL ./omnisetup.sh -IS1
```

- ## 3. If you are installing from the mounted CD-ROM or the CD-ROM image, repeat the steps 1 and 2 with the second Installation Server installation CD-ROM, but use the `omnisetup.sh -IS2` parameter instead of `-IS1`.

Installing UNIX Clients from CD-ROMs

Limitation

Local installation of UNIX packages is possible *only from the HP-UX Installation Server installation CD-ROM*. This includes all UNIX clients. This means that you need to use the HP-UX Installation Server installation CD-ROM to install the Solaris or Linux client and not the Solaris or Linux Installation Server installation CD-ROM.

Installation procedure

The installation procedure is similar to the procedure for installing from the UNIX Installation Server DVD-ROM; however, after you finish the installation from the first CD-ROM, insert the second CD-ROM and run the installation again.

For details see “[Installing a UNIX Cell Manager](#)” on page 43.

Additional steps and tasks when upgrading Data Protector from CD-ROMs

The procedure for upgrading Data Protector from the CD-ROMs is similar to the procedure for upgrading from DVD-ROM.

- **On UNIX**, the installation packages are split in to 3 CD-ROMs (one for the Cell Manager and two for the Installation Server); as a result you need to continue the upgrade from the additional CD-ROMs.
- **On Windows**, each platform is contained on 1 CD-ROM; as a result, the Windows upgrade procedure from the CD-ROM is identical to the installation from the DVD-ROMs, except for the changed installation path:
32-bit OS (on x86 or AMD64/Intel EM64T): \i386\setup.exe
64-bit OS (on AMD64/Intel EM64T): \x8664\setup.exe
64-bit OS (on Itanium): \ia64\setup.exe (only for clients)

Upgrading a UNIX Cell Manager

To upgrade the HP-UX, Solaris or Linux Cell Manager to Data Protector A.06.10, follow the procedure described below:

1. Insert and mount the appropriate installation CD-ROM to a mountpoint.

For example:

```
mkdir /cdrom mount /dev/c0d0t0 /cdrom
```

Optionally, you can install Data Protector from a depot on the disk, perform the following:

- Copy the DP_DEPOT, AUTOPASS, and LOCAL_INSTALL directories, where the installation files are stored:

```
mkdir directory cp -r /cdrom/DP_DEPOT directory cp -r /cdrom/AUTOPASS directory cp -r /cdrom/LOCAL_INSTALL directory
```

- Copy the whole CD-ROM to your local disk:

```
cp -r /cdrom cd_image_dir
```

2. Run the `omnisetup.sh` command.

To run this command from the CD-ROM, execute:

```
cd /cdrom/LOCAL_INSTALL ./omnisetup.sh
```

To start the installation from disk, run:

- If you have copied the `DP_DEPOT` and `LOCAL_INSTALL` directory from the CD-ROM to your local disk under *directory*, go to the directory where the `omnisetup.sh` command is stored, and run:

```
cd directory/LOCAL_INSTALL ./omnisetup.sh
```

- If you have copied the whole CD-ROM to `cd_image_dir`, run the `omnisetup.sh` command without any parameters:

```
cd cd_image_dir/LOCAL_INSTALL ./omnisetup.sh
```

3. `omnisetup.sh` prompts you to install or upgrade the HP OpenView AutoPass utility if you want to download and install passwords for the purchased licenses directly through the internet from the HP password delivery center web server. For more information on the AutoPass utility, refer to [“Obtaining and installing permanent passwords using the HP AutoPass utility”](#) on page 323. It is recommended to install AutoPass.

If AutoPass is installed on MC/ServiceGuard, it must be installed or upgraded on all nodes.

When prompted, press **Return** to install or upgrade AutoPass. If you do not want to install or upgrade AutoPass, enter **n**.

After the A.05.10, A.05.50, or A.06.00 version of Data Protector is detected, the upgrade procedure is automatically started. If you want to perform a clean installation, uninstall the old version and restart the installation.

For details about installation, refer to [“Installing a UNIX Cell Manager”](#) on page 43 and [“Installing Installation Servers for UNIX”](#) on page 61.

4. If you are upgrading from Data Protector A.05.10 and have Windows clients in the cell, you will be informed that conversion of file names in the IDB will be performed. The IDB conversion is necessary to correctly handle file names with international characters. Refer to [“Conversion of file names in the IDB”](#) on page 279 for details.

Upgrading a UNIX Installation Server

The HP-UX, Solaris or Linux Installation Server is upgraded automatically when the `omnisetup.sh` command is run.

On HP-UX, this command directly upgrades the existing package set using the `swinstall` utility. On Solaris, this command removes the existing package set using the `pkgrm` utility and installs new packages using the `pkgadd` utility. On Linux, this command directly upgrades the existing package set using `rpm`.

If the Installation Server is installed with client components, it will be removed by the `omnisetup.sh` command. In this case, install a new Installation Server depot using the `omnisetup.sh -IS` command, and then reimport the upgraded Installation Server. For details, refer to [“Importing an installation server to a cell”](#) on page 210.

Upgrade procedure

To upgrade the HP-UX, Solaris or Linux Installation Server to Data Protector A.06.10, follow the procedure described below:

1. Insert and mount the appropriate installation CD-ROM to a mount point.

For example:

```
mkdir /cdrom mount /dev/c0d0t0 /cdrom
```

Optionally, to install Data Protector from a depot on the disk, perform the following:

- To copy the `DP_DEPOT` and `LOCAL_INSTALL` directories, where the installation files are stored, on your local disk, proceed as follows:

```
mkdir directory cp -r /cdrom/DP_DEPOT directory cp -r /cdrom/LOCAL_INSTALL directory
```

Mount the second Installation Server installation CD-ROM and copy all the files from the `DP_DEPOT` directory to the installation directory as well:

```
cp -r /cdrom/DP_DEPOT directory
```

- To copy the whole CD-ROM to your local disk, run:

```
cp -r /cdrom cd_image_dir
```

2. Run the `omnisetup.sh` command.

To run this command from the CD-ROM, execute:

```
cd /cdrom/LOCAL_INSTALL ./omnisetup.sh
```

To start the installation from disk, perform one of the following steps:

- If you have copied the `DP_DEPOT` and `LOCAL_INSTALL` directory from the CD-ROM to your local disk under *directory*, go to the directory where the `omnisetup.sh` command is stored, and run:

```
cd directory/LOCAL_INSTALL ./omnisetup.sh
```

- If you have copied the whole CD-ROM to *cd_image_dir*, run the `omnisetup.sh` command without any parameters:

```
cd cd_image_dir/LOCAL_INSTALL ./omnisetup.sh
```

3. If you have run `omnisetup.sh` from the CD-ROM or copied the entire CD-ROM to the disk, repeat the steps using the second Installation Server installation CD-ROM.

Glossary

access rights	See user rights .
ACSL	<i>(StorageTek specific term)</i> The Automated Cartridge System Library Server (ACSL) software that manages the Automated Cartridge System (ACS).
Active Directory	<i>(Windows specific term)</i> The directory service in a Windows network. It contains information about resources on the network and makes them accessible to users and applications. The directory services provide a consistent way to name, describe, locate, access and manage resources regardless of the physical system they reside on.
AML	<i>(EMASS/GRAU specific term)</i> Automated Mixed-Media library.
application agent	A component needed on a client to back up or restore online database integrations. See also Disk Agent .
application system	<i>(ZDB specific term)</i> A system the application or database runs on. The application or database data is located on source volumes. See also backup system and source volume .
archived redo log	<i>(Oracle specific term)</i> Also called offline redo log. If the Oracle database operates in the ARCHIVELOG mode, as each online redo log is filled, it is copied to an archived log destination. This copy is the archived redo log. The presence or absence of an archived redo log is determined by the mode the database is using: <ul style="list-style-type: none">• ARCHIVELOG - The filled online redo log files are archived before they are reused. The database can be recovered if an instance or a disk fails. A “hot” backup can be performed only when the database is running in this mode.

- NOARCHIVELOG - The filled online redo log files are not archived.

See also [online redo log](#).

archive logging	<i>(Lotus Domino Server specific term)</i> Lotus Domino Server database mode where transaction log files are overwritten only after they have been backed up.
ASR Set	A collection of files stored on several diskettes, required for proper reconfiguration of the replacement disk (disk partitioning and logical volume configuration) and automatic recovery of the original system configuration and user data that was backed up during the full client backup. These files are stored as an ASR archive file on the Cell Manager (in <code>Data_Protector_home\Config\Server\dr\asr</code> on a Windows Cell Manager or in <code>/etc/opt/omni/server/dr/asr/</code> on a UNIX Cell Manager) as well as on the backup medium. The ASR archive file is extracted to three diskettes for 32-bit Windows systems or four diskettes for 64-bit Windows systems after a disaster occurs. You need these diskettes to perform ASR.
Audit Logs	Data files to which auditing information is stored.
Audit Report	User-readable output of auditing information created from data stored in audit log files.
Auditing Information	Data about every backup session that was performed over an extended, user-defined period for the whole Data Protector cell.
autochanger	See library .
autoloader	See library .
Automatic Storage Management	<i>(Oracle specific term)</i> Automatic Storage Management is an Oracle 10g integrated filesystem and volume manager that manages Oracle database files. It eliminates complexity associated with managing data and disk and provides striping and mirroring capabilities to optimize performance.
automigration	<i>(VLS specific term)</i> The functionality that allows data backups to be first made to the VLS' virtual tapes and then migrated to physical tapes (one virtual tape emulating one physical tape) without using an intermediate backup application.

See also [Virtual Library System \(VLS\)](#) and [virtual tape](#).

BACKINT	<p>(SAP R/3 specific term) SAP R/3 backup programs can call the Data Protector backint interface program via an open interface, which enables them to communicate with Data Protector software. For backup and restore, SAP R/3 programs issue orders for the Data Protector backint interface.</p>
backup API	<p>The Oracle interface between the Oracle backup/restore utility and the backup/restore media management layer. The interface defines a set of routines to allow the reading and writing of data to the backup media, the creation, searching and removing the backup files.</p>
backup chain	<p>See restore chain.</p>
backup device	<p>A device configured for use with Data Protector, which can write data to and read data from storage media. This can be, for example, a standalone DDS/DAT drive or a library.</p>
backup generation	<p>One backup generation includes one full backup and all incremental backups until the next full backup.</p>
backup ID	<p>An identifier of an integration object that equals the session ID of the backup of this object. The backup ID is preserved when an object is copied, exported, or imported.</p>
backup object	<p>A backup unit that contains all items backed up from one disk volume (logical disk or mount point). The backed up items can be any number of files, directories, or the entire disk or mount point. Additionally, a backup object can be a database/application entity or a disk image (rawdisk). A backup object is defined by:</p> <ul style="list-style-type: none">• Client name: Hostname of the Data Protector client where the backup object resides.• Mount point: For filesystem objects — the access point in a directory structure on the client where the backup object is located (drive on Windows and mount point on UNIX). For integration objects — backup stream identification, indicating the backed up database/application items.• Description: For filesystem objects — uniquely defines objects with identical client name and mount point. For integration

objects — displays the integration type (for example, SAP or Lotus).

- Type: Backup object type. For filesystem objects — filesystem type (for example, WinFS). For integration objects — “Bar”.

backup owner	Each backup object in the IDB has an owner. The default owner of a backup is the user who starts the backup session.
backup session	A process that creates a copy of data on storage media. The activities are specified in a backup specification or an interactive session. All clients configured in one backup specification are backed up together in one backup session using the same backup type (full or incremental). The result of a backup session is a set of media, which was written to, also called the backup or media set. See also backup specification , incremental backup , and full backup .
backup set	A complete set of integration objects associated with a backup.
backup set	<i>(Oracle specific term)</i> A logical grouping of backed up files that are created using the RMAN backup command. A backup set is a complete set of files associated with a backup. The files can be multiplexed to increase performance. A backup set contains either datafiles or archived logs, but not both together.
backup specification	A list of objects to be backed up, together with a set of devices or drives to be used, backup options for all objects in the specification, and days and time that you want backups to be performed. The objects are entire disks/volumes or parts of them such as files, directories, or even the Windows Registry for example. File selection lists such as include-lists and exclude-lists can be specified.
backup system	<i>(ZDB specific term)</i> A system connected to target volumes of one or multiple application systems. The backup system is typically connected to a backup device to perform the backup of the data in a replica. See also application system , target volume , and replica .
backup types	See incremental backup , differential backup , transaction backup , full backup , and delta backup .

backup to IAP	A Data Protector based backup to the HP Integrated Archiving Platform (IAP) appliance. It takes advantage of the IAP capability to eliminate redundancies in the stored data at a block (or chunk) level, by creating a unique content address for each data chunk. Only changed chunks are transmitted over the network and added to the store.
backup view	Data Protector provides different views for backup specifications: By Type - according to the type of data available for backups/templates. Default view. By Group - according to the group to which backup specifications/templates belong. By Name - according to the name of backup specifications/templates. By Manager - if you are running MoM, you can also set the Backup view according to the Cell Manager to which backup specifications/templates belong.
BC	<i>(EMC Symmetrix specific term)</i> Business Continuance are processes that allow customers to access and manage instant copies of EMC Symmetrix standard devices. See also BCV .
BC	<i>(HP StorageWorks Disk Array XP specific term)</i> The Business Copy XP allows to maintain internal copies of HP StorageWorks Disk Array XP LDEVs for purposes such as data backup or data duplication. The copies (secondary volumes or S-VOLs) can be separated from the primary volumes (P-VOLs) and connected to a different system for various purposes, such as backup and development. For backup purposes, P-VOLs should be connected to the application system, and one of the S-VOL mirror sets should be connected to the backup system. See also HP StorageWorks Disk Array XP LDEV, CA, Main Control Unit, application system, and backup system .
BC EVA	<i>(HP StorageWorks EVA specific term)</i> Business Copy EVA is a local replication software solution enabling you to create point-in-time copies (replicas) of the source volumes using the snapshot and clone capabilities of the EVA firmware. See also replica , source volume , snapshot , and CA+BC EVA .
BC Process	<i>(EMC Symmetrix specific term)</i> A protected storage environment solution that has defined specially configured EMC Symmetrix

devices as mirrors or Business Continuance Volumes to protect data on EMC Symmetrix standard devices.
See also [BCV](#).

BC VA *(HP StorageWorks Virtual Array specific term)* Business Copy VA allows you to maintain internal copies of HP StorageWorks Virtual Array LUNs for data backup or data duplication within the same virtual array. The copies (child or Business Copy LUNs) can be used for various purposes, such as backup, data analysis or development. When used for backup purposes, the original (parent) LUNs are connected to the application system and the Business Copy (child) LUNs are connected to the backup system. See also [HP StorageWorks Virtual Array LUN](#), [application system](#), and [backup system](#).

BCV *(EMC Symmetrix specific term)* Business Continuance Volumes, or BCV devices, are dedicated SLDs that are pre-configured in the ICDA on which the business continuation operation runs. BCV devices are assigned separate SCSI addresses, differing from the addresses used by the SLDs they mirror. The BCV devices are used as splittable mirrors of the primary EMC Symmetrix SLDs that need to be protected. See also [BC](#) and [BC Process](#).

Boolean operators The Boolean operators for the full text search functionality of the online Help system are AND, OR, NOT, and NEAR. Used when searching, they enable you to define your query precisely by creating a relationship between search terms. If no operator is specified in a multi-word search, AND is used by default. For example, the query manual disaster recovery is equivalent to manual AND disaster AND recovery.

boot volume/disk/partition A volume/disk/partition with files required for the initial step of the boot process. Microsoft terminology defines the boot volume/disk/partition as a volume/disk/partition containing the operating system files.

BRARCHIVE *(SAP R/3 specific term)* An SAP R/3 backup tool that allows you to archive redo log files. BRARCHIVE also saves all the logs and profiles of the archiving process. See also [BRBACKUP](#), and [BRRESTORE](#).

BRBACKUP *(SAP R/3 specific term)* An SAP R/3 backup tool that allows an online or offline backup of the control file, of individual data

files, or of all tablespaces and, if necessary, of the online redo log files.

See also [BRARCHIVE](#), and [BRRESTORE](#).

BRRESTORE

(SAP R/3 specific term) An SAP R/3 tool that can be used to restore files of the following type:

- Database data files, control files, and online redo log files saved with BRBACKUP
- Redo log files archived with BRARCHIVE
- Non-database files saved with BRBACKUP

You can specify files, tablespaces, complete backups, log sequence numbers of redo log files, or the session ID of the backup.

See also [BRBACKUP](#), and [BRARCHIVE](#).

BSM

The Data Protector Backup Session Manager controls the backup session. This process always runs on the Cell Manager system.

CA

(HP StorageWorks Disk Array XP specific term) Continuous Access XP allows you to create and maintain remote copies of HP StorageWorks Disk Array XP LDEVs for purposes such as data duplication, backup, and disaster recovery. CA operations involve the main (primary) disk arrays and the remote (secondary) disk arrays. The main disk arrays contain the CA primary volumes (P-VOLs), which contain the original data and are connected to the application system. The remote disk arrays contain the CA secondary volumes (S-VOLs) connected to the backup system.

See also [BC](#) *(HP StorageWorks Disk Array XP specific term)*, [Main Control Unit](#) and [HP StorageWorks Disk Array XP LDEV](#).

CA+BC EVA

(HP StorageWorks EVA specific term) The combination of Continuous Access (CA) EVA and Business Copy (BC) EVA enables you to create and maintain copies (replicas) of the source volumes on a remote EVA, and then use these copies as the source for local replication on this remote array.

See also [BC EVA](#), [replica](#), and [source volume](#).

CAP

(StorageTek specific term) Cartridge Access Port is a port built into the door panel of a library. The purpose is to enter or eject media.

catalog protection	Defines how long information about backed up data (such as file names and file versions) is kept in the IDB. <i>See also</i> data protection .
CDB	The Catalog Database is a part of the IDB that contains information about backups, object copies, restores, media management sessions,, and backed up data. Depending on the selected logging level, it also contains file names and file versions. This part of the database is always local to the cell. <i>See also</i> MMDB .
CDF file	<i>(UNIX specific term)</i> A Context Dependent File is a file consisting of several files grouped under the same pathname. The system ordinarily selects one of the files using the context of the process. This mechanism allows machine dependent executables, system data, and device files to work correctly from all hosts in a cluster while using the same pathname.
cell	A set of systems that are under the control of a Cell Manager. The cell typically represents the systems on a site or an organizational entity, which are connected to the same LAN. Central control is available to administer the backup and restore policies and tasks.
Cell Manager	The main system in the cell where the essential Data Protector software is installed and from which all backup and restore activities are managed. The GUI used for management tasks can be located on a different system. Each cell has one Cell Manager system.
centralized licensing	Data Protector allows you to configure centralized licensing for the whole enterprise environment consisting of several cells. All Data Protector licenses are installed and kept on the Enterprise Cell Manager system. You can then allocate licenses to specific cells to suit your needs. <i>See also</i> MoM .
Centralized Media Management Database (CMMDB)	<i>See</i> CMMDB .

Change Journal	<i>(Windows specific term)</i> A Windows filesystem feature that logs a record of each change as it occurs to the files and directories on a local NTFS volume.
Change Log Provider	<i>(Windows specific term)</i> A module that can be queried to determine which objects on a filesystem have been created, modified, or deleted.
channel	<p><i>(Oracle specific term)</i> An Oracle Recovery Manager resource allocation. Every allocated channel starts a new Oracle process, which performs backup, restore, and recovery actions. The type of channel allocated determines the type of media used:</p> <ul style="list-style-type: none"> • type 'disk' • type 'sbt_tape' <p>If the specified channel is of type 'sbt_tape' and Oracle is integrated with Data Protector, the server process will attempt to read backups from or write data files to Data Protector.</p>
chunking	<p><i>(IAP specific term)</i> The process of dividing data into blocks (chunks), where each chunk gets a unique content address. This address is then used to determine whether a particular chunk is already backed up to the IAP appliance. If the duplicate data is identified (two addresses are identical, that is the address is the same as for another data chunk already stored into IAP), it is not backed up. This way, the data redundancy is eliminated and the optimal data storage is achieved.</p> <p>See also backup to IAP.</p>
circular logging	<i>(Microsoft Exchange Server and Lotus Domino Server specific term)</i> Circular logging is a Microsoft Exchange Server database and Lotus Domino Server database mode, in which the transaction log file contents are periodically overwritten after the corresponding data is committed to the database. Circular logging reduces disk storage space requirements.
client backup	A backup of all filesystems mounted on a client. Filesystems mounted on the client after the backup specification was created are not automatically detected.
client backup with disk discovery	A backup of all filesystems mounted on a client. When the backup starts, Data Protector discovers the disks on the clients. Client backup with disk discovery simplifies backup configuration

and improves backup coverage of systems that often mount or dismount disks.

client or **client system** Any system configured with any Data Protector functionality and configured in a cell.

cluster-aware application It is an application that supports the cluster Application Programming Interface. Each cluster-aware application declares its own critical resources (disk volumes (on Microsoft Cluster Server), volume groups (on MC/ServiceGuard), application services, IP names and addresses, and so on).

Cluster Continuous Replication (*Microsoft Exchange Server specific term*) Cluster continuous replication (CCR) is a high availability solution that uses cluster management and failover options to create and maintain an exact copy (CCR copy) of a storage group. A storage group is replicated to a separate server. CCR removes any single point of failure in your Exchange back-end servers. You can perform backups using VSS on your passive Exchange Server node where a CCR copy is located and thus reducing the load on the active node. A CCR copy is used for disaster recovery since you can switch to the CCR copy in a few seconds. A replicated storage group is represented as a new instance of Exchange writer called Exchange Replication Service and can be backed up (using VSS) like an ordinary storage group. See also [Exchange Replication Service](#) and [Local Continuous Replication](#).

CMD Script for Informix Server (*Informix Server specific term*) A Windows CMD script that is created in INFORMIXDIR when an Informix Server database is configured. The CMD script is a set of system commands that export environment variables for Informix Server.

CMMDB The Data Protector Centralized Media Management Database (CMMDB) is the result of merging MMDBs from several cells in the MoM environment. It allows you to share high-end devices and media across multiple cells in a MoM environment. One cell can control the robotics, serving the devices that are connected to systems in other cells. The CMMDB must reside on the MoM Manager. A reliable network connection between the MoM cell and the other Data Protector cells is highly recommended. See also [MoM](#).

COM+ Registration Database	<i>(Windows specific term)</i> The COM+ Registration Database and the Windows Registry store COM+ application attributes, class attributes, and computer-level attributes. This guarantees consistency among these attributes and provides common operation on top of these attributes.
command-line interface (CLI)	A set of DOS and UNIX like commands that you can use in shell scripts to perform Data Protector configuration, backup, restore, and management tasks.
Command View (CV) EVA	<i>(HP StorageWorks EVA specific term)</i> The user interface that enables you to configure, manage, and monitor your HP StorageWorks EVA storage system. It is used to perform various storage management tasks, for example, creating virtual disk families, managing storage system hardware, and creating snapclones and snapshots of virtual disks. The Command View EVA software runs on the HP OpenView Storage Management Appliance, and is accessed by a Web browser. See also HP StorageWorks EVA SMI-S Agent and HP StorageWorks SMI-S EVA provider .
Command View VLS	<i>(VLS specific term)</i> A web browser-based GUI that is used to configure, manage, and monitor the VLS through a LAN. See also Virtual Library System (VLS) .
concurrency	See Disk Agent concurrency .
control file	<i>(Oracle and SAP R/3 specific term)</i> An Oracle data file that contains entries specifying the physical structure of the database. It provides database consistency information used for recovery.
copy set	<i>(HP StorageWorks EVA specific term)</i> A pair that consists of the source volumes on a local EVA and their replica on a remote EVA. See also source volume , replica , and CA+BC EVA
CRS	The Cell Request Server process (service), which runs on the Data Protector Cell Manager, and starts and controls the backup and restore sessions. The service is started as soon as Data Protector is installed on the Cell Manager. On Windows systems, the CRS runs under the account of the user specified at installation time. On UNIX systems, it runs under the account <code>root</code> .

CSM	The Data Protector Copy and Consolidation Session Manager process controls the object copy and object consolidation sessions and runs on the Cell Manager system.
data file	<i>(Oracle and SAP R/3 specific term)</i> A physical file created by Oracle that contains data structures such as tables and indexes. A data file can only belong to one Oracle database.
data protection	Defines how long the backed up data on media remains protected, that is, Data Protector will not overwrite it. When the protection expires, Data Protector will be able to reuse the media in one of the next backup sessions. <i>See also catalog protection.</i>
data stream	Sequence of data transferred over the communication channel.
database library	A Data Protector set of routines that enables data transfer between Data Protector and a server of an online database integration, for example, Oracle Server.
database parallelism	More than one database is backed up at a time if the number of available devices allows you to perform backups in parallel.
Data Replication (DR) group	<i>(HP StorageWorks EVA specific term)</i> A logical grouping of EVA virtual disks. It can contain up to eight copy sets provided they have common characteristics and share a common CA EVA log. <i>See also copy set.</i>
database server	A computer with a large database stored on it, such as the SAP R/3 or Microsoft SQL database. A server has a database that can be accessed by clients.
Dobject	<i>(Informix Server specific term)</i> An Informix Server physical database object. It can be a blob space, db space, or logical log file.
DC directory	The Detail Catalog (DC) directory contains DC binary files, which store information about file versions. It represents the DCBF part of the IDB, which occupies approximately 80% of the IDB. The default DC directory is called the <code>dcbf</code> directory and is located in the <code>Data_Protector_home\db40</code> directory on a Windows Cell Manager and in the <code>/var/opt/omni/server/db40</code> directory on a UNIX Cell

Manager. You can create more DC directories and use a custom location. Up to 10 DC directories are supported per cell. The default maximum size of a DC directory is 16 GB.

DCBF	The Detail Catalog Binary Files (DCBF) part of the IDB stores information about file versions and attributes. It occupies approximately 80% of the IDB. One DC binary file is created for each Data Protector medium used for backup. Its maximum size is limited by the file system settings.
delta backup	A delta backup is a backup containing all the changes made to the database from the last backup of any type. See also backup types .
device	A physical unit which contains either just a drive or a more complex unit such as a library.
device chain	A device chain consists of several standalone devices configured for sequential use. When a medium in one device gets full, the backup automatically continues on a medium in the next device in the device chain.
device group	<i>(EMC Symmetrix specific term)</i> A logical unit representing several EMC Symmetrix devices. A device cannot belong to more than a single device group. All devices in a device group must be on the same EMC Symmetrix unit. You can use a device group to identify and work with a subset of the available EMC Symmetrix devices.
device streaming	A device is streaming if it can feed enough data to the medium to keep it moving forward continuously. Otherwise, the tape has to be stopped, the device waits for more data, reverses the tape a little and resumes to write to the tape, and so on. In other words, if the data rate written to the tape is less or equal the data rate which can be delivered to the device by the computer system, then the device is streaming. Streaming significantly improves the performance of the device and use of space.
DHCP server	A system running the Dynamic Host Configuration Protocol (DHCP) providing dynamic IP address assignment and network configuration for DHCP clients.

differential backup	An incremental backup that backs up changes made since the last full backup. To perform this type of backup, specify the Incr1 backup type. See also incremental backup .
differential backup	<i>(Microsoft SQL Server specific term)</i> A database backup that records only the data changes made to the database after the last full database backup. See also backup types .
differential database backup	A differential database backup records only those data changes made to the database after the last full database backup.
direct backup	A SAN-based backup solution in which data movement directly from disk to tape (or to other secondary storage) is facilitated by the SCSI Extended Copy (Xcopy) command. Direct backup lessens the backup I/O load on systems in a SAN environment. The data movement is facilitated directly from disk to tape (or to other secondary storage) by the SCSI Extended Copy (XCOPY) command. The command is provided by any element of the infrastructure including bridges, switches, tape libraries, and disk subsystems. See also XCOPY engine .
directory junction	<i>(Windows specific term)</i> Directory junctions use the reparse point concept of Windows. An NTFS 5 directory junction allows you to redirect a directory/file request to another location.
disaster recovery	A process to restore a client's main system disk to a state close to the time when a (full) backup was performed.
Disk Agent	A component needed on a client to back it up and restore it. The Disk Agent controls reading from and writing to a disk. During a backup session, the Disk Agent reads data from a disk and sends it to the Media Agent, which then moves it to the device. During a restore session the Disk Agent receives data from the Media Agent and writes it to the disk.
Disk Agent concurrency	The number of Disk Agents that are allowed to send data to one Media Agent concurrently.
disk discovery	The detection of disks during client backup with disk discovery. During this backup, Data Protector discovers (detects) the disks that are present on the client — even though they might not have

been present on the system when the backup was configured — and backs them up. This is particularly useful in dynamic environments, where configurations change rapidly. After the disks are expanded, each inherits all options from its master client object. Even if pre- and post-exec commands are specified once, they are started many times, once per each object.

disk group	<i>(Veritas Volume Manager specific term)</i> The basic unit of data storage in VxVM system. A disk group can consist of one or more physical volumes. There can be more than one disk group on the system.
disk image (rawdisk) backup	A high-speed backup where Data Protector backs up files as bitmap images. A disk image (rawdisk) backup does not track the files and directory structure stored on the disk, but stores a disk image structure on byte level. You can perform a disk image backup of either specific disk sections or a complete disk.
disk quota	A concept to manage disk space consumption for all or a subset of users on a computer system. This concept is used by several operating system platforms.
disk staging	The process of backing up data in several phases to improve the performance of backups and restores, reduce costs of storing the backed up data, and increase the data availability and accessibility for restore. The backup stages consist of backing up data to one media type first (for example disk) and later copying it to a different media type (for example tape).
distributed file media format	A media format, available with the file library, which supports a space efficient type of synthetic backup called virtual full backup. Using this format is a prerequisite for virtual full backup. See also virtual full backup .
Distributed File System (DFS)	A service that connects file shares into a single namespace. The file shares can reside on the same or on different computers. DFS provides client access to the resources in a location-transparent manner.
DMZ	The Demilitarized Zone (DMZ) is a network inserted as a "neutral zone" between a company's private network (intranet) and the outside public network (Internet). It prevents outside users from getting direct access to company servers in the intranet.

DNS server	In the DNS client-server model, this is the server containing information about a portion of the DNS database that makes computer names available to client resolvers querying for name resolution across the Internet.
domain controller	A server in a network that is responsible for user security and verifying passwords within a group of other servers.
DR image	Data required for temporary disaster recovery operating system (DR OS) installation and configuration.
DR OS	A disaster recovery operating system is an operating system environment in which disaster recovery runs. It provides Data Protector a basic runtime environment (disk, network, tape, and filesystem access). The OS has to be installed and configured before the Data Protector disaster recovery can be performed. DR OS not only hosts the Data Protector disaster recovery process but is also a part of the restored system because it replaces its own configuration data with the original configuration data.
drive	A physical unit that receives data from a computer system and can write it onto a magnetic medium (typically a tape drive). It can also read the data from the medium and send it to the computer system.
drive index	A number that identifies the mechanical position of a drive inside a library device. This number is used by the robotic control to access a drive.
dynamic client	See client backup with disk discovery .
EMC Symmetrix Agent (SYMA) (EMC Symmetrix specific term)	See Symmetrix Agent (SYMA) .
emergency boot file	<i>(Informix Server specific term)</i> The Informix Server configuration file <code>ixbar.server_id</code> that resides in the directory <code>INFORMIXDIR/etc</code> (on Windows) or <code>INFORMIXDIR\etc</code> (on UNIX). <code>INFORMIXDIR</code> is the Informix Server home directory and <code>server_id</code> is the value of the <code>SERVERNUM</code> configuration parameter. Each line of the emergency boot file corresponds to one backup object.

enhanced incremental backup	Conventional incremental backup backs up files that have changed since a previous backup, but has certain limitations in detection of changes. Unlike conventional incremental backup, enhanced incremental backup reliably detects and backs up also renamed and moved files, as well as files with changes in attributes.
Enterprise Backup Environment	Several cells can be grouped together and managed from a central cell. The enterprise backup environment includes all clients located in several Data Protector cells which are managed and administered from a central cell using the Manager-of-Managers concept. <i>See also MoM.</i>
Event Log (Data Protector Event Log)	A central repository of all Data Protector related notifications. By default, all notifications are sent to the Event Log. The Event Log is accessible only to Data Protector users in the <code>Admin</code> group and to Data Protector users who are granted the <code>Reporting and notifications</code> user rights. You can view or delete all events in the Event Log.
Event Logs	Files in which Windows logs all events, such as the starting or stopping of services and the logging on and off of users. Data Protector can back up Windows Event Logs as part of the Windows configuration backup.
Exchange Replication Service	<i>(Microsoft Exchange Server specific term)</i> The Microsoft Exchange Server service that represents storage groups that were replicated using either Local Continuous Replication (LCR) or Cluster Continuous Replication (CCR) technology. <i>See also Cluster Continuous Replication and Local Continuous Replication.</i>
exchanger	Also referred to as SCSI Exchanger. <i>See also library.</i>
exporting media	A process that removes all data about backup sessions, such as systems, objects, and file names, which reside on the media from the IDB. Information about the media and their relation to a pool is also removed from the IDB. The data on the media remains unchanged. <i>See also importing media.</i>

Extensible Storage Engine (ESE)	<i>(Microsoft Exchange Server specific term)</i> A database technology used as a storage system for information exchange in Microsoft Exchange Server.
failover	Transferring of the most important cluster data, called group (on Windows) or package (on UNIX) from one cluster node to another. A failover can occur mostly because of software or hardware failures or maintenance on the primary node.
failover	<i>(HP StorageWorks EVA specific term)</i> An operation that reverses the roles of source and destination in CA+BC EVA configurations. See also CA+BC EVA .
FC bridge	See Fibre Channel bridge .
Fibre Channel	An ANSI standard for high-speed computer interconnection. Using either optical or copper cables, it allows the high speed bi-directional transmission of large data files and can be deployed between sites kilometers apart. Fibre Channel connects nodes using three physical topologies: point-to-point, loop, and switched.
Fibre Channel bridge	A Fibre Channel bridge or multiplexer provides the ability to migrate existing parallel SCSI devices, like RAID arrays, solid state disks (SSD), and tape libraries to a Fibre Channel environment. On one side of the bridge or multiplexer there is a Fibre Channel interface while on the other side there are parallel SCSI ports. The bridge or multiplexer enables SCSI packets to be moved between the Fibre Channel and parallel SCSI devices.
file depot	A file containing the data from a backup to a file library device.
file jukebox device	A device residing on disk consisting of multiple slots used to store file media.
file library device	A device which resides on a disk emulating a library with several media, hence containing multiple files, referred to as file depots.
File Replication Service (FRS)	A Windows service that replicates the domain controller store logon scripts and group policies. FRS also enables replication of Distributed File System (DFS) shares between systems and allows any server to perform replication activity.

file tree walk	<i>(Windows specific term)</i> The process of traversing a filesystem to determine which objects have been created, modified, or deleted.
file version	The same file can be backed up multiple times in case of full backups and incremental backups (if the file changed). If the log level ALL is selected for backup, Data Protector retains one entry in the IDB for the filename itself and one for each version (date/time) of the file.
filesystem	The organization of files on a hard disk. A filesystem is backed up so that the file attributes and the file contents are stored on the backup media.
first-level mirror	<i>(HP StorageWorks Disk Array XP specific term)</i> HP StorageWorks Disk Array XP allows up to three mirror copies of a primary volume and each of these copies can have additional two copies. The three mirror copies are called first-level mirrors. See also primary volume and MU number .
flash recovery area	<i>(Oracle specific term)</i> Flash recovery area is an Oracle 10g managed directory, filesystem, or Automatic Storage Management disk group that serves as a centralized storage area for files related to backup and recovery (recovery files). See also recovery files .
fnames.dat	The <code>fnames.dat</code> files of the IDB contain information on the names of the backed up files. Typically, these files occupy about 20% of the IDB, if filenames are stored.
formatting	A process that erases any data contained on a medium and prepares it for use with Data Protector. Information about media (medium ID, description, and location) is saved in the IDB as well as on the respective media (media header). Data Protector media with protected data are not formatted until the protection expires or the media are unprotected/recycled.
free pool	An auxiliary source of media for use by media pools when they run out of media. The media pools must be configured to use free pools.
full backup	A backup in which all selected objects are backed up, whether or not they have been recently modified. See also backup types .

full database backup	A backup of all data in a database, not only the data that has been changed after the last (full or incremental) backup of the database. A full database backup does not depend on any other backup.
full mailbox backup	A full mailbox backup is a backup of the entire mailbox content.
full ZDB	A ZDB to tape or ZDB to disk+tape session in which all selected objects are streamed to tape, even if there are no changes from the previous backup. See also incremental ZDB .
global options file	A file that allows you to customize Data Protector. It explains the global options, which cover various aspects of Data Protector, typically time-outs and limits, and affect the entire Data Protector cell. The file is located in the <code>/etc/opt/omni/server/options</code> directory on HP-UX and Solaris systems and in the <code>Data_Protector_home\Config\Server\Options</code> directory on Windows systems.
group	<i>(Microsoft Cluster Server specific term)</i> A collection of resources (for example disk volumes, application services, IP names, and addresses) that are needed to run a specific cluster-aware applications.
GUI	A cross-platform (HP-UX, Solaris, Linux, and Windows) graphical user interface, provided by Data Protector for easy access to all configuration, administration, and operation tasks. Besides the original Data Protector GUI, Data Protector also provides a Java-based graphical user interface with the same look and feel. As Java can run on numerous platforms, the Data Protector Java GUI is supported on a larger number of platforms than the original Data Protector GUI.
hard recovery	<i>(Microsoft Exchange Server specific term)</i> A Microsoft Exchange Server database recovery that is performed after a restore by the database engine, using transaction log files.
heartbeat	A cluster data set with a time stamp carrying information about the operational status of a particular cluster node. This data set or packet is distributed among all cluster nodes.

Hierarchical Storage Management (HSM)	A method for optimizing the use of expensive hard disk storage by migrating less frequently used data to less expensive optical platters. When needed, the data is migrated back to hard disk storage. This balances the need for fast retrieval from hard disk with the lower cost of optical platters.
Holidays file	A file that contains information about holidays. You can set different holidays by editing the Holidays file: /etc/opt/omni/server/Holidays on the UNIX Cell Manager and Data_Protector_home\Config\Server\holidays on the Windows Cell Manager.
host backup	See client backup with disk discovery .
hosting system	A working Data Protector client used for Disk Delivery Disaster Recovery with a Data Protector Disk Agent installed.
HP ITO	See OM .
HP OpC	See OM .
HP OpenView SMART Plug-In (SPI)	A fully integrated, out-of-the-box solution which "plugs into" HP Operations Manager software, extending the managed domain. Through the Data Protector integration, which is implemented as an HP OpenView SMART Plug-In, a user can have an arbitrary number of Data Protector Cell Managers monitored as an extension to HP Operations Manager software (OM).
HP OM	See OM
HP StorageWorks Disk Array XP LDEV	A logical partition of a physical disk within an HP StorageWorks Disk Array XP. LDEVs are entities that can be replicated in the Continuous Access XP (CA) and Business Copy XP (BC) configurations, or can be used as standalone entities. See also BC , CA (HP StorageWorks Disk Array XP specific term), and replica .
HP StorageWorks EVA SMI-S Agent	A Data Protector software module that executes all tasks required for the HP StorageWorks Enterprise Virtual Array integration. With the EVA SMI-S Agent, the control over the array is established through HP StorageWorks SMI-S EVA provider, which directs communication between incoming requests and CV EVA.

See also [Command View \(CV\) EVA](#) and [HP StorageWorks SMI-S EVA provider](#).

HP StorageWorks SMI-S EVA provider

An interface used for controlling HP StorageWorks Enterprise Virtual Array. SMI-S EVA provider runs as a separate service on the HP OpenView Storage Management Appliance system and acts as a gateway between incoming requests and Command View EVA. With the Data Protector HP StorageWorks EVA integration, SMI-S EVA provider accepts standardized requests from the EVA SMI-S Agent, communicates with Command View EVA for information or method invocation, and returns standardized responses.

See also [HP StorageWorks EVA SMI-S Agent](#) and [Command View \(CV\) EVA](#).

HP StorageWorks Virtual Array LUN

A logical partition of a physical disk within an HP StorageWorks Virtual Array. LUNs are entities that can be replicated in the HP StorageWorks Business Copy VA configuration, or can be used as standalone entities.

See also [BC VA](#) and [replica](#).

HP VPO

See [OM](#).

ICDA

(EMC Symmetrix specific term) EMC's Symmetrix Integrated Cached Disk Arrays (ICDA) is a disk array device that combines a set of physical disks, a number of FWD SCSI channels, an internal cache memory, and control and diagnostic software commonly referred to as the microcode.

IDB

The Data Protector Internal Database is an embedded database located on the Cell Manager that keeps information regarding which data is backed up, on which media it is backed up, how backup and restore sessions are run, and which devices and libraries are configured.

IDB recovery file

An IDB file (obrindex.dat) with information about IDB backups, media, and devices used for the backup. This information can significantly simplify IDB recovery. It is recommended to relocate the file, together with IDB transaction logs, to a separate physical disk from other IDB directories, and, additionally, to make an additional copy of the file.

importing media	A process that re-reads all data about backup sessions which are on the medium back into the IDB. This then allows for fast and convenient access to the data on the media. <i>See also exporting media.</i>
incremental backup	A backup that selects only files that have changed since a previous backup. Several levels of incremental backup are available, which enables detailed control of restore chain length. <i>See also backup types.</i>
incremental backup	<i>(Microsoft Exchange Server specific term)</i> A backup of the Microsoft Exchange Server data that has changed since the last full or incremental backup. With the incremental backup, only the transaction log files are backed up. <i>See also backup types.</i>
incremental mailbox backup	An incremental mailbox backup backs up all the changes made to the mailbox after the last backup of any type.
incremental1 mailbox backup	An incremental1 mailbox backup backs up all the changes made to the mailbox after the last full backup.
incremental (re)-establish	<i>(EMC Symmetrix specific term)</i> A BCV or SRDF control operation. In BCV control operations, an incremental establish causes the BCV device to be synchronized incrementally and to function as an EMC Symmetrix mirrored medium. The EMC Symmetrix devices must have been previously paired. In SRDF control operations, an incremental establish causes the target (R2) device to be synchronized incrementally and to function as an EMC Symmetrix mirrored medium. The EMC Symmetrix devices must have been previously paired.
incremental restore	<i>(EMC Symmetrix specific term)</i> A BCV or SRDF control operation. In BCV control operations, an incremental restore reassigns a BCV device as the next available mirror of the standard device in the pair. However, the standard devices are updated with only the data that was written to the BCV device during the time of the original pair split, and the data that was written to the standard device during the split is overwritten with data from the BCV mirror. In SRDF control operations, an incremental restore reassigns a target (R2) device as the next available mirror of the source (R1) device in the pair. However, the source (R1) devices are updated with only the data that was written to the target (R2) device during the time of the original pair split, and

the data that was written to the source (R1) device during the split is overwritten with data from the target (R2) mirror.

- incremental ZDB** A filesystem ZDB to tape or ZDB to disk+tape session in which only changes from the last protected full or incremental backup are streamed to tape.
See also [full ZDB](#).
- Inet** A process that runs on each UNIX system or service that runs on each Windows system in the Data Protector cell. It is responsible for communication between systems in the cell and for starting other processes needed for backup and restore. The Inet service is started as soon as Data Protector is installed on a system. The Inet process is started by the inetd daemon.
- Information Store** (*Microsoft Exchange Server specific term*) The Microsoft Exchange Server service that is responsible for storage management. Information Store in Microsoft Exchange Server manages two kinds of stores: mailbox stores and public folder stores. A mailbox store consists of mailboxes that belong to individual users. A public folder store contains public folders and messages that are shared among several users.
See also [Key Management Service](#) and [Site Replication Service](#).
- Informix Server** (*Informix Server specific term*) Refers to Informix Dynamic Server.
- initializing** See [formatting](#).
- Installation Server** A computer system that holds a repository of the Data Protector software packages for a specific architecture. The Installation Server is used for remote installation of Data Protector clients. In mixed environments at least two Installation Servers are needed: one for UNIX systems and one for Windows systems.
- instant recovery** (*ZDB specific term*) A process in which a replica, produced by a ZDB-to-disk or a ZDB-to-disk+tape session, is used to restore the contents of the source volumes to their states at the time at which the replica was created, avoiding the need to perform a restore from tape. Depending on the application or database concerned, this may be all that is required, or other steps, such as the application of transaction log files, may be required for full recovery.
See also [replica](#), [zero downtime backup \(ZDB\)](#), [ZDB to disk](#), and [ZDB to disk+tape](#).

integration object	A backup object of a Data Protector integration, such as Oracle or SAP DB.
Internet Information Services (IIS)	<i>(Windows specific term)</i> Microsoft Internet Information Services is a network file and application server that supports multiple protocols. Primarily, IIS transmits information in Hypertext Markup Language (HTML) pages by using the Hypertext Transport Protocol (HTTP).
IP address	An Internet Protocol address is a numeric address of a system used to uniquely identify the system on the network. The IP address consists of four groups of numbers separated by periods (full stops).
ISQL	<i>(Sybase specific term)</i> A Sybase utility used to perform system administration tasks on Sybase SQL Server.
ITO	See OM .
Java GUI Client	The Java GUI Client is a component of the Java GUI that contains only user interface related functionalities and requires connection to the Java GUI Server to function.
Java GUI Server	The Java GUI Server is a component of the Java GUI that is installed on the Data Protector Cell Manager system. The Java GUI Server receives requests from the Java GUI Client, processes them and then sends the responses back to the Java GUI Client. The communication is done through Hypertext Transfer Protocol (HTTP) on port 5556.
jukebox	See library .
jukebox device	A device consisting of multiple slots used to store either optical or file media. When being used to store file media, the jukebox device is known as the “file jukebox device”.
Key Management Service	<i>(Microsoft Exchange Server specific term)</i> The Microsoft Exchange Server service that provides encryption functionality for enhanced security. See also Information Store and Site Replication Service .
keychain	A tool that eliminates the supply of a passphrase manually when decrypting the private key. It needs to be installed and

configured on the Installation Server if you perform remote installation using secure shell.

- LBO** *(EMC Symmetrix specific term)* A Logical Backup Object (LBO) is an object of data storage/retrieval in the EMC Symmetrix environment. It is stored/retrieved by EMC Symmetrix as one entity and can only be restored as a whole.
- library** Also called autochanger, jukebox, autoloader, or exchanger. A library contains media in repository slots. Each slot holds one medium (for example, DDS/DAT). Media are moved between slots and drives by a robotic mechanism, allowing random access to media. The library can contain multiple drives.
- lights-out operation** or **unattended operation** A backup or restore operation that takes place outside of normal business hours without an operator. This implies that no operator personnel is present to work with the backup application or service mount requests, for example.
- LISTENER.ORA** *(Oracle specific term)* An Oracle configuration file that describes one or more Transparent Network Substrate (TNS) listeners on a server.
- load balancing** By default, Data Protector automatically balances the usage of devices selected for backup, so that they are used evenly. Load balancing optimizes the device usage by balancing the number of objects written to each device. Since load balancing is done automatically during backup time, you do not need to manage how the data is actually backed up. You just specify the devices to be used. If you do not want to use load balancing, you can select which device will be used for each object in the backup specification. Data Protector will access the devices in the specified order.
- local and remote recovery** Remote recovery is performed if all Media Agent hosts specified in the SRD file are accessible. If any of them fails, the disaster recovery process fails over to the local mode. This means that the target system is searched for locally attached devices. If only one device is found, it is automatically used. Otherwise, Data Protector prompts you to select the device, which will be used for restore.

Local Continuous Replication	<p>(<i>Microsoft Exchange Server specific term</i>) Local continuous replication (LCR) is a single-server solution that creates and maintains an exact copy (LCR copy) of a storage group. An LCR copy is located on the same server as the original storage group. When an LCR copy is created, it is kept up to date through change propagation (log replay) technology. The replication feature in LCR guarantees that logs that have not been replicated are not deleted. The implication of this behavior is that running backups in a mode that deletes logs may not actually free space if replication is sufficiently far behind in its log copying. An LCR copy is used for disaster recovery because you can switch to the LCR copy in a few seconds. If an LCR copy is used for backup and if it is located on a different disk than the original data, then the I/O load on a production database is minimal. A replicated storage group is represented as a new instance of Exchange writer called Exchange Replication Service and can be backed up (using VSS) as a normal storage group. See also Cluster Continuous Replication and Exchange Replication Service.</p>
lock name	<p>You can configure the same physical device several times with different characteristics, by using different device names. The lock name is a user specified string that is used for locking all such device configurations to prevent collision if several such devices (device names) are used concurrently. Use an identical lock name for all device definitions which use the same physical device.</p>
log_full shell script	<p>(<i>Informix Server UNIX specific term</i>) A script provided by ON-Bar that you can use to start backing up logical log files when Informix Server issues a logfull event alarm. The Informix Server <code>ALARMPROGRAM</code> configuration parameter defaults to the <code>INFORMIXDIR/etc/log_full.sh</code>, where <code>INFORMIXDIR</code> is the Informix Server home directory. If you do not want logical logs to be backed up continuously, set the <code>ALARMPROGRAM</code> configuration parameter to <code>INFORMIXDIR/etc/no_log.sh</code>.</p>
logging level	<p>The logging level determines the amount of details on files and directories written to the IDB during backup, object copying, or object consolidation. You can always restore your data, regardless of the logging level used during backup. Data Protector provides four logging levels: Log All, Log Directories, Log Files, and No Log. The different logging level settings</p>

influence the IDB growth, backup speed, and the convenience of browsing data for restore.

logical-log files

This applies to online database backup. Logical-log files are files in which modified data is first stored before being flushed to disk. In the event of a failure, these logical-log files are used to roll forward all transactions that have been committed as well as roll back any transactions that have not been committed.

login ID

(Microsoft SQL Server specific term) The name a user uses to log on to Microsoft SQL Server. A login ID is valid if Microsoft SQL Server has an entry for that user in the system table syslogin.

login information to the Oracle Target Database

(Oracle and SAP R/3 specific term) The format of the login information is *user_name/password@service*, where:

- *user_name* is the name by which a user is known to Oracle Server and to other users. Every user name is associated with a password and both have to be entered to connect to an Oracle Target Database. This user must have Oracle SYSDBA or SYSOPER rights.
- *password* must be the same as the password specified in the Oracle password file (*orapwd*), which is used for authentication of users performing database administration.
- *service* is the name used to identify an SQL*Net server process for the target database.

login information to the Recovery Catalog Database

(Oracle specific term) The format of the login information to the Recovery (Oracle) Catalog Database is *user_name/password@service*, where the description of the user name, password, and service name is the same as in the Oracle SQL*Net V2 login information to the Oracle target database. In this case, *service* is the name of the service to the Recovery Catalog Database, not the Oracle target database. Note that the Oracle user specified here must be the owner of the Oracle Recovery Catalog.

Lotus C API

(Lotus Domino Server specific term) An interface for the exchange of backup and recovery information between Lotus Domino Server and a backup solution, like Data Protector.

LVM

A Logical Volume Manager is a subsystem for structuring and mapping physical disk space to logical volumes on UNIX

systems. An LVM system consists of several volume groups, where each volume group has several volumes.

Magic Packet	See Wake ONLAN .
mailbox	<i>(Microsoft Exchange Server specific term)</i> The location to which e-mail is delivered, which is set up by the administrator for each user. If a set of personal folders is designated as the e-mail delivery location, e-mail is routed from the mailbox to this location.
mailbox store	<i>(Microsoft Exchange Server specific term)</i> A part of the Information Store that maintains information in user mailboxes. A mailbox store consists of a binary rich-text <code>.edb</code> file and a streaming native internet content <code>.stm</code> file.
Main Control Unit (MCU)	<i>(HP StorageWorks Disk Array XP specific term)</i> An HP StorageWorks XP disk array that contains the primary volumes for the CA and BC configurations and acts as a master device. See also BC (HP StorageWorks Disk Array XP specific term), CA (HP StorageWorks Disk Array XP specific term), and HP StorageWorks Disk Array XP LDEV .
Manager-of-Managers (MoM)	See MoM .
MAPI	<i>(Microsoft Exchange Server specific term)</i> The MAPI (Messaging Application Programming Interface) is the programming interface that lets applications and messaging clients interact with messaging and information systems.
MCU	See Main Control Unit (MCU) .
Media Agent	A process that controls reading from and writing to a device, which reads from or writes to a medium (typically a tape). During a backup session, a Media Agent receives data from the Disk Agent and sends it to the device for writing it to the medium. During a restore session, a Media Agent locates data on the backup medium and sends it to the Disk Agent. The Disk Agent then writes the data to the disk. A Media Agent also manages the robotics control of a library.
media allocation policy	Determines in which sequence media are used for backup. The Strict allocation policy directs Data Protector to prompt for a

specific medium. The Loose policy directs Data Protector to prompt for any suitable medium. The Formatted First policy directs Data Protector to give preference to unknown media, even if unprotected media are available in the library.

media condition	The quality of a medium as derived from the media condition factors. Heavy usage and age result in an increased number of read and write errors with tape media. Media need to be replaced when they are marked as POOR.
media condition factors	The user-assigned age threshold and overwrite threshold used to determine the state of a medium.
medium ID	A unique identifier assigned to a medium by Data Protector.
media label	A user-defined identifier used to describe a medium.
media location	A user-defined physical location of a medium, such as "building 4" or "off-site storage".
media management session	A session performing some action on a medium, such as initializing, scanning the content, verifying data on a medium, or copying a medium.
media pool	A set of media of the same type (such as DDS) used and tracked as a group. Media are formatted and assigned to a media pool.
media set	The result of a backup session is data backed up on a group of media called media set. Depending on the media usage policy, several sessions can share the same media.
media type	The physical type of media, such as DDS or DLT.
media usage policy	The media usage policy controls how new backups are added to the already used media. It can be <code>Appendable</code> , <code>Non-Appendable</code> , or <code>Appendable for incrementals only</code> .
merging	This defines one mode to resolve file conflicts during restore. If the file to be restored already exists at the destination, the one with the more recent modification date is kept. Files not present on the disk are always restored. <i>See also overwrite.</i>

Microsoft Exchange Server	A "client-server" messaging and a workgroup system that offers a transparent connection to many different communication systems. It provides users with an electronic mail system, individual and group scheduling, online forms, and workflow automation tools. It provides a developer with a platform on which to build custom information-sharing and messaging-service applications.
Microsoft Management Console (MMC)	<i>(Windows specific term)</i> An administration model for Windows-based environments. It provides a simple, consistent, and integrated administration user interface allowing management of many applications through the same GUI, provided that the applications adhere to the MMC model.
Microsoft SQL Server	A database management system designed to meet the requirements of distributed "client-server" computing.
Microsoft Volume Shadow Copy Service (VSS)	A software service that provides a unified communication interface to coordinate backup and restore of a VSS-aware application regardless of its specific features. This service collaborates with the backup application, writers, shadow copy providers, and the operating system kernel to implement the management of volume shadow copies and shadow copy sets. See also shadow copy , shadow copy provider , replica , and writer .
mirror (EMC Symmetrix and HP StorageWorks Disk Array XP specific term)	See target volume .
mirror rotation (HP StorageWorks Disk Array XP specific term)	See replica set rotation .
MMD	The Media Management Daemon process (service) runs on the Data Protector Cell Manager and controls media management and device operations. The process is started when Data Protector is installed on the Cell Manager.
MMDB	The Media Management Database (MMDB) is a part of the IDB that contains information about media, media pools, devices,

libraries, library drives, and slots configured in the cell, as well as the Data Protector media used for backup. In an enterprise backup environment, this part of the database can be common to all cells.

See also [CMMDB](#), [CDB](#).

MoM	Several cells can be grouped together and managed from a central cell. The management system of the central cell is the Manager-of-Managers (MoM). The cells are called MoM clients. The MoM enables you to configure and manage multiple cells from a central point.
mount request	A screen prompt that tells you to insert a specific medium into a device. Once you respond to the mount request by providing the required medium and confirm the mount request, the session continues.
mount point	The access point in a directory structure for a disk or logical volume, for example <code>/opt</code> or <code>d:</code> . On UNIX, the mount points are displayed using the <code>bdf</code> or <code>df</code> command.
MSM	The Data Protector Media Session Manager, which runs on the Cell Manager and controls media sessions, such as copying media.
MU number	<i>(HP StorageWorks Disk Array XP specific term)</i> Mirror Unit number. An integer number (0, 1 or 2), used to indicate a first-level mirror. See also first-level mirror .
multi-drive server	A license that allows you to run an unlimited number of Media Agents on a single system. This license, which is bound to the IP address of the Cell Manager, is no longer available.
obdrindex.dat	See IDB recovery file .
OBDR capable device	A device that can emulate a CD-ROM drive loaded with a bootable disk and can thus be used as a backup or boot device for disaster recovery purposes.
object	See backup object .
object consolidation	The process of merging a restore chain of a backup object, consisting of a full backup and at least one incremental backup,

into a new, consolidated version of this object. The process is a part of the synthetic backup procedure. The result is a synthetic full backup of the specified backup object.

object consolidation session	A process that merges a restore chain of a backup object, consisting of a full backup and at least one incremental backup, into a new, consolidated version of this object.
object copy	A copy of a specific object version that is created during an object copy session or a backup session with object mirroring.
object copy session	A process that creates an additional copy of the backed up data on a different media set. During an object copy session, the selected backed up objects are copied from the source to the target media.
object copying	The process of copying selected object versions to a specific media set. You can select object versions from one or several backup sessions to be copied.
object ID	<i>(Windows specific term)</i> The object IDs (OIDs) enable access to NTFS 5 files no matter where in the system the files reside. Data Protector treats the OIDs as alternate streams of the files.
object mirror	A copy of a backup object created using object mirroring. Object mirrors are often referred to as object copies.
object mirroring	The process of writing the same data to several media sets during a backup session. Data Protector enables you to mirror all or some backup objects to one or more media sets.
offline backup	<p>A backup during which an application database cannot be used by the application.</p> <ul style="list-style-type: none">• For simple backup methods (non ZDB), the database is generally put into a quiescent state that allows use by the backup system, but not the application, for the whole backup period (several minutes or hours). For instance, for backup to tape, until streaming of data to the tape is finished.• For ZDB methods, the database is also put into the quiescent state, but for the period of the data replication process only (several seconds). Normal database operation can then be resumed for the rest of the backup process. <p>See also zero downtime backup (ZDB) and online backup.</p>

offline recovery	Offline recovery is performed if the Cell Manager is not accessible, for example, due to network problems. Only standalone and SCSI library devices can be used for offline recovery. Recovery of the Cell Manager is always offline.
offline redo log	See archived redo log .
On-Bar	<p><i>(Informix Server specific term)</i> A backup and restore system for Informix Server. ON-Bar enables you to create a copy of your Informix Server data and later restore the data. The ON-Bar backup and restore system involves the following components:</p> <ul style="list-style-type: none"> • the <code>onbar</code> command • Data Protector as the backup solution • the XBSA interface • ON-Bar catalog tables, which are used to back up dbobjects and track instances of dbobjects through multiple backups.
ONCONFIG	<p><i>(Informix Server specific term)</i> An environment variable that specifies the name of the active ONCONFIG configuration file. If the ONCONFIG environment variable is not present, Informix Server uses the configuration values from the <code>onconfig</code> file in the directory <code>INFORMIXDIR\etc</code> (on Windows) or <code>INFORMIXDIR/etc/</code> (on UNIX).</p>
online backup	<p>A backup performed while a database application remains available for use. The database is placed into a special backup mode of operation for the time period that the backup application requires access to the original data objects. During this period, the database is fully operational, but there may be a small performance impact and log files may grow very quickly.</p> <ul style="list-style-type: none"> • For simple backup methods (non ZDB), backup mode is required for the whole backup period (several minutes or hours). For instance, for backup to tape, until streaming of data to tape is finished. • For ZDB methods, backup mode is required for the short period of the data replication process only (several seconds). Normal database operation can then be resumed for the rest of the backup process. <p>In some cases, transaction logs may also have to be backed up to allow a consistent database to be restored. See also zero downtime backup (ZDB), and offline backup.</p>

online redo log	<i>(Oracle specific term)</i> Redo logs that have not been archived, but are either available to the instance for recording database activity or are filled and waiting to be archived or reused. See also archived redo log .
OpC	See OM .
OpenSSH	A set of network connectivity tools used to access remote machines securely, by using a variety of authentication and encryption methods. It needs to be installed and configured on the Installation Server and the client if you perform remote installation using secure shell.
Oracle Data Guard	<i>(Oracle specific term)</i> Oracle Data Guard is Oracle's primary disaster recovery solution. Oracle Data Guard is able to maintain up to nine standby databases, each of which is a real-time copy of the production (primary) database, to protect against corruptions, data failures, human errors, and disasters. If a failure occurs on the production (primary) database, then a failover to one of the standby databases which becomes the new primary database is possible. In addition, planned downtime for maintenance can be reduced because the production processing can be moved from the current primary database to a standby database and back quickly.
Oracle instance	<i>(Oracle specific term)</i> Each installation of an Oracle database on one or more systems. One computer system can have several instances of a database running.
ORACLE_SID	<i>(Oracle specific term)</i> A unique name for an Oracle Server instance. To switch among Oracle Servers, specify the desired <code>ORACLE_SID</code> . The <code>ORACLE_SID</code> is included in the <code>CONNECT DATA</code> parts of the connect descriptor in a <code>TNSNAMES.ORA</code> file and in the definition of the TNS listener in the <code>LISTENER.ORA</code> file.
original system	The system configuration backed up by Data Protector before a computer disaster hits the system.
overwrite	An option that defines one mode to resolve file conflicts during restore. All files are restored from a backup even if they are older than existing files. See also merging .

OM	<p>HP Operations Manager software for UNIX provides powerful capabilities for operations management of a large number of systems and applications on in a network. Data Protector provides an integration into this management product. This integration is implemented as a SMART Plug-In for OM management servers on HP-UX, Solaris, and Linux. Earlier versions of OM were called IT/Operation, Operations Center and Vantage Point Operations.</p> <p>See also merging.</p>
ownership	<p>The ownership of a backup determines who can restore from the backup. The user who starts an interactive backup is the session owner. If a user starts an existing backup specification without modifying it, the session is not considered interactive. In that case, if the backup owner has been defined in the backup specification, they remain the session owner. Otherwise, the session owner becomes the user who started the backup in question. For the scheduled backups, by default, the session owner is for the UNIX Cell Manager: <code>root.sys@Cell Manager</code>, and for the Windows Cell Manager, the user that was specified during the installation of the Cell Manager. It is possible to modify the ownership, so that the specific user becomes the session owner.</p>
P1S file	<p>P1S file contains information on how to format and partition all disks installed in the system during Enhanced Automated Disaster Recovery (EADR). It is created during full backup and is saved on backup medium and on Cell Manager into <code>Data_Protector_home\Config\Server\dr\pls</code> directory on a Windows Cell Manager or in <code>/etc/opt/omni/server/dr/pls</code> directory on a UNIX Cell Manager with the filename <code>recovery.pls</code>.</p>
package	<p><i>(MC/ServiceGuard and Veritas Cluster specific term)</i> A collection of resources (for example volume groups, application services, IP names and addresses) that are needed to run a specific cluster-aware application.</p>
pair status	<p><i>(HP StorageWorks Disk Array XP specific term)</i> A mirrored pair of disks can have various status values depending on the action performed on it. The three most important status values are:</p>

- COPY - The mirrored pair is currently re-synchronizing. Data is transferred from one disk to the other. The disks do not contain the same data.
- PAIR - The mirrored pair is completely synchronized and both disks (the primary volume and the mirrored volume) contain identical data.
- SUSPENDED - The link between the mirrored disks is suspended. That means that both disks are accessed and updated independently. However, the mirror relationship is still maintained and the pair can be re-synchronized without transferring the complete disk.

parallel restore Restoring backed up data to multiple disks at the same time (that is, in parallel) by running multiple Disk Agents, that receive data from one Media Agent. For the parallel restore to work, select data that is located on different disks or logical volumes and during backup, the data from the different objects must have been sent to the same device using a concurrency of 2 or more. During a parallel restore, the data for multiple objects selected for restore is read from media at the same time, thereby improving performance.

parallelism The concept of reading multiple data streams from an online database.

physical device A physical unit that contains either a drive or a more complex unit such as a library.

post-exec A backup option that executes a command or script after the backup of an object or after the entire session completes. Post-exec commands are not supplied by Data Protector. You need to create your own. They can be written as executables or batch files on Windows and as shell scripts on UNIX. See also [pre-exec](#).

pre- and post-exec commands Pre- and post-exec commands are used to perform additional action before and after a backup or restore session. They are not supplied by Data Protector. You need to create your own commands. They can be written as executables or batch files on Windows and as shell scripts on UNIX.

prealloc list A subset of media in a media pool that specifies the order in which media are used for backup.

pre-exec	A backup option that executes a command or script before the backup of an object or before the entire session is started. Pre-exec commands are not supplied by Data Protector. You need to create your own. They can be written as executables or batch files on Windows and as shell scripts on UNIX. See also post-exec .
primary volume (P-VOL)	<i>(HP StorageWorks Disk Array XP specific term)</i> Standard HP StorageWorks Disk Array XP LDEVs that act as a primary volume for the CA and BC configurations. The P-VOL is located in the MCU. See also secondary volume (S-VOL) and Main Control Unit (MCU) .
protection	See data protection and also catalog protection .
public folder store	<i>(Microsoft Exchange Server specific term)</i> The part of the Information Store that maintains information in public folders. A public folder store consists of a binary rich-text <code>.edb</code> file and a streaming native internet content <code>.stm</code> file.
public/private backed up data	When configuring a backup, you can select whether the backed up data will be: <ul style="list-style-type: none"> • public, that is visible (and accessible for restore) to all Data Protector users • private, that is, visible (and accessible for restore) only to the owner of the backup and administrators
RAID	Redundant Array of Inexpensive Disks.
RAID Manager Library	<i>(HP StorageWorks Disk Array XP specific term)</i> The RAID Manager Library is used internally by Data Protector on Solaris systems to allow access to HP StorageWorks Disk Array XP configuration, status, and performance data and to key HP StorageWorks Disk Array XP features through the use of function calls translated into a sequence of low level SCSI commands.
RAID Manager XP	<i>(HP StorageWorks Disk Array XP specific term)</i> The RAID Manager XP application provides an extensive list of commands to report and control the status of the CA and BC applications. The commands communicate through a RAID Manager instance with the HP StorageWorks Disk Array XP Disk Control Unit. This

instance translates the commands into a sequence of low level SCSI commands.

rawdisk backup	See disk image backup .
RCU	See Remote Control Unit (RCU) .
RDBMS	Relational Database Management System.
RDF1/RDF2	<i>(EMC Symmetrix specific term)</i> A type of SRDF device group. Only RDF devices can be assigned to an RDF group. An RDF1 group type contains source (R1) devices and an RDF2 group type contains target (R2) devices.
RDS	The Raima Database Server process (service) runs on the Data Protector Cell Manager and manages the IDB. The process is started when Data Protector is installed on the Cell Manager.
Recovery Catalog	<i>(Oracle specific term)</i> A set of Oracle tables and views that are used by Recovery Manager to store information about Oracle databases. This information is used by Recovery Manager to manage the backup, restore, and recovery of Oracle databases. The recovery catalog contains information about: <ul style="list-style-type: none">• The physical schema of the Oracle target database• Data file and archived log backup sets• Data file copies• Archived Redo Logs• Stored scripts
Recovery Catalog Database	<i>(Oracle specific term)</i> An Oracle database that contains a recovery catalog schema. You should not store the recovery catalog in your target database.
recovery files	<i>(Oracle specific term)</i> Recovery files are Oracle 10g specific files that reside in the flash recovery area: the current control file, online redo logs, archived redo logs, flashback logs, control file autobackups, datafile copies, and backup pieces. See also flash recovery area .
RecoveryInfo	When backing up Windows configuration files, Data Protector collects the information about the current system configuration (information on disk layout, volume, and network configuration). This information is needed for disaster recovery.

Recovery Manager (RMAN)	<i>(Oracle specific term)</i> An Oracle command-line interface that directs an Oracle Server process to back up, restore, or recover the database it is connected to. RMAN uses either the recovery catalog or the control file to store information about backups. This information can be used later in restore sessions.
recycle	A process that removes the data protection from all backed up data on a medium, allowing Data Protector to overwrite it during one of the next backups. Data that belongs to the same session(s) but resides on other media is also unprotected. Recycling does not actually alter the data on the medium.
redo log	<i>(Oracle specific term)</i> Every Oracle database has a set of two or more redo log files. The set of redo log files for the database is known as the database's redo log. Oracle uses the redo log to record all changes made to data.
Remote Control Unit (RCU)	<i>(HP StorageWorks Disk Array XP specific term)</i> The Remote Control Unit (RCU) acts as a slave of an MCU in a CA configuration. In bidirectional configurations, the RCU can act as an MCU.
Removable Storage Management Database	<i>(Windows specific term)</i> A Windows service used for managing removable media (such as tapes and disks) and storage devices (libraries). Removable Storage allows applications to access and share the same media resources.
reparse point	<i>(Windows specific term)</i> A system-controlled attribute that can be associated with any directory or file. The value of a reparse attribute can have user-controlled data. The format of the data is understood by the application that stored the data and a filesystem filter that was installed to interpret the data and process such files. Whenever the filesystem encounters a file with a reparse point, it attempts to find the filesystem filter associated with the data format.
replica	<i>(ZDB specific term)</i> An image, at a particular point in time, of the data in source volumes that contain user-specified backup objects. Depending on the hardware or software with which it is created, the image may be an independent exact duplicate (clone) of the storage blocks at the physical disk level (for example, a split mirror or snapclone), or a virtual copy (for example, a snapshot). From perspective of a basic operating system, the complete physical disk containing backup objects

is replicated. However, if a volume manager is used on UNIX, the whole volume or disk group containing a backup object (logical volume) is replicated. If partitions are used on Windows, the whole physical volume containing the selected partition is replicated.

See also [snapshot](#), [snapshot creation](#), [split mirror](#), and [split mirror creation](#).

- replica set** *(ZDB specific term)* A group of replicas, all created using the same backup specification.
See also [replica](#) and [replica set rotation](#).
- replica set rotation** *(ZDB specific term)* The use of a replica set for regular backup production: Each time the same backup specification requiring the use of a replica set is run, a new replica is created and added to the set, until the maximum number for the set is reached. After that, the oldest replica in the set is replaced, maintaining the maximum number of replicas in the set.
See also [replica](#) and [replica set](#).
- restore chain** All backups that are necessary for a restore of a backup object to a certain point in time. A restore chain consists of a full backup of the object and any number of related incremental backups.
- restore session** A process that copies data from backup media to a client.
- resync mode** *(HP StorageWorks Disk Array XP VSS provider specific term)* One of two XP VSS hardware provider operation modes. When the XP provider is in the resync mode, the source volume (P-VOL) and its replica (S-VOL) are in the suspended mirror relationship after a backup. The maximum number of replicas (S-VOLs per a P-VOL) rotated is three provided that MU range is 0-2 or 0, 1, 2. Restore from a backup in such a configuration is possible only by re-synchronization of an S-VOL with its P-VOL.
See also [VSS compliant mode](#), [source volume](#), [primary volume \(P-VOL\)](#), [replica](#), [secondary volume \(S-VOL\)](#), [MU number](#), and [replica set rotation](#).
- RMAN (Oracle specific term)** See [Recovery Manager](#).
- RSM** The Data Protector Restore Session Manager controls the restore session. This process always runs on the Cell Manager system.

RSM	<i>(Windows specific term)</i> Removable Storage Manager (RSM) includes a media management service that facilitates communication among applications, robotic changers, and media libraries. It enables multiple applications to share local robotic media libraries and tape or disk drives and to manage removable media.
scan	A function that identifies the media in a device. This synchronizes the MMDB with the media that are actually present at the selected locations (for example, slots in a library).
scanning	A function which identifies the media in a device. This synchronizes the MMDB with the media that are actually present at the selected locations (for example, slots in a library). It is useful to perform a scan and check the actual media in the device if someone has manually manipulated media without using Data Protector to eject or enter, for example.
Scheduler	A function that controls when and how often automatic backups occur. By setting up a schedule, you automate the start of backups.
secondary volume (S-VOL)	<i>(HP StorageWorks Disk Array XP specific term)</i> secondary volumes, or S-VOLs, are XP LDEVs that act as a secondary CA or BC mirror of another LDEV (a P-VOL). In the case of CA, S-VOLs can be used as failover devices in a MetroCluster configuration. The S-VOLs are assigned separate SCSI addresses, different from the addresses used by the P-VOLs. See also primary volume (P-VOL) and Main Control Unit (MCU)
session	See backup session , media management session , and restore session .
session ID	An identifier of a backup, restore, object copy, object consolidation, or media management session, consisting of the date when the session ran and a unique number.
session key	This environment variable for the pre-exec and post-exec script is a Data Protector unique identification of any session, including preview sessions. The session key is not recorded in the database, and it is used for specifying options for the <code>omnimnt</code> , <code>omnistat</code> , and <code>omniabort</code> commands.

shadow copy	<p><i>(Microsoft VSS specific term)</i> A volume that represents a duplicate of the original volume at a certain point in time. The data is then backed up from the shadow copy and not from the original volume. The original volume continues to change as the backup process continues, but the shadow copy of the volume remains constant.</p> <p>See also Microsoft Volume Shadow Copy Service and replica.</p>
shadow copy provider	<p><i>(Microsoft VSS specific term)</i> An entity that performs the work on creating and representing the volume shadow copies. Providers own the shadow copy data and expose the shadow copies. Providers can be software (for example, system providers) or hardware (local disks, disk arrays).</p> <p>See also shadow copy.</p>
shadow copy set	<p><i>(Microsoft VSS specific term)</i> A collection of shadow copies created at the same point in time.</p> <p>See also shadow copy and replica set.</p>
shared disks	<p>A Windows disk on another system that has been made available to other users on the network. Systems with shared disks can be backed up without a Data Protector Disk Agent installed.</p>
SIBF	<p>The Serverless Integrations Binary Files (SIBF) is a part of the IDB that stores raw NDMP meta data. This data is necessary to perform restore of NDMP objects.</p>
single instancing	<p><i>(IAP specific term)</i> The process of recognizing redundancy of data, at both a whole object and a chunk level. It computes a strong hash for each data chunk and uses it as a unique content address needed to determine whether attempts to store duplicates are being made.</p> <p>See also backup to IAP.</p>
Site Replication Service	<p><i>(Microsoft Exchange Server specific term)</i> The Microsoft Exchange Server 2000/2003 service that permits compatibility with Microsoft Exchange Server 5.5 by emulating the Exchange Server 5.5 directory service.</p> <p>See also Information Store and Key Management Service.</p>
slot	<p>A mechanical position in a library. Each slot can hold a medium, such as a DLT tape. Data Protector references each slot with a</p>

number. To read a medium, a robotic mechanism moves the medium from a slot into the drive.

- SMB** See [split mirror backup](#).
- smart copy** (*VLS specific term*) A copy of the backed up data created from the virtual tape to the physical tape library. The smart copy process allows Data Protector to distinguish between the source and the target medium thus enabling media management. See also [Virtual Library System \(VLS\)](#).
- smart copy pool** (*VLS specific term*) A pool that defines which destination library slots are available as smart copy targets for a specified source virtual library. See also [Virtual Library System \(VLS\)](#) and [smart copy](#).
- SMBF** The Session Messages Binary Files (SMBF) part of the IDB stores session messages generated during backup, restore, object copy, object consolidation, and media management sessions. One binary file is created per session. The files are grouped by year and month.
- snapshot** (*HP StorageWorks VA and HP StorageWorks EVA specific term*) A form of replica produced using snapshot creation techniques. A range of snapshot types is available, with different characteristics, depending on the arrays/techniques used. Such replicas are dynamic and may be either virtual copies, still reliant upon the contents of the source volumes, or independent exact duplicates (clones), depending on the snapshot type and the time since creation. See also [replica](#) and [snapshot creation](#).
- snapshot backup**
(*HP StorageWorks VA and HP StorageWorks EVA specific term*) See [ZDB to tape](#), [ZDB to disk](#), and [ZDB to disk+tape](#).
- snapshot creation** (*HP StorageWorks VA and HP StorageWorks EVA specific term*) A replica creation technique, in which copies of source volumes are created using storage virtualization techniques. The replicas are considered to be created at one particular point in time, without pre-configuration, and are immediately available for

use. However background copying processes normally continue after creation.

See also [snapshot](#).

- source (R1) device** *(EMC Symmetrix specific term)* An EMC Symmetrix device that participates in SRDF operations with a target (R2) device. All writes to this device are mirrored to a target (R2) device in a remote EMC Symmetrix unit. An R1 device must be assigned to an RDF1 group type.
See also [target \(R2\) device](#).
- source volume** *(ZDB specific term)* A storage volume containing data to be replicated.
- sparse file** A file that contains data with portions of empty blocks. Examples are: a matrix in which some or much of the data contains zeros, files from image applications, and high-speed databases. If sparse file processing is not enabled during restore, it might be impossible to restore this file.
- split mirror** *(EMC Symmetrix and HP StorageWorks Disk Array XP specific term)* A replica created using split mirror techniques. Such a replica provides an independent, exact duplicate, or clone of the contents of the source volumes.
See also [replica](#) and [split mirror creation](#).
- split mirror backup** *(EMC Symmetrix specific term)* See [ZDB to tape](#).
- split mirror backup** *(HP StorageWorks Disk Array XP specific term)* See [ZDB to tape](#), [ZDB to disk](#), and [ZDB to disk+tape](#).
- split mirror creation** *(EMC Symmetrix and HP StorageWorks Disk Array XP specific term)* A replica creation technique, in which a pre-configured set of target volumes (a mirror) is kept synchronized with a set of source volumes until the time at which a replica of the contents of the source volumes is required. Then, the synchronization is stopped (the mirror is split) and a split mirror replica of the source volumes at the time of the split remains in the target volumes.
See also [split mirror](#).

split mirror restore	<i>(EMC Symmetrix and HP StorageWorks Disk Array XP specific term)</i> A process in which data backed up in a ZDB-to-tape or a ZDB-to-disk+tape session is restored from tape media to a split mirror replica, which is then synchronized to the source volumes. Individual backup objects or complete sessions can be restored using this method. See also ZDB to tape , ZDB to disk+tape , and replica .
sqlhosts file	<i>(Informix Server specific term)</i> An Informix Server connectivity information file (on UNIX) or registry (on Windows) that contains the names of each of the database servers and any aliases to which the clients on a host computer can connect.
SRD file	The Data Protector System Recovery Data (SRD) file contains system information required for installing and configuring the operating system in case of a disaster. The SRD file is an ASCII file, generated when a CONFIGURATION backup is performed on a Windows client and stored on the Cell Manager.
SRDF	<i>(EMC Symmetrix specific term)</i> The EMC Symmetrix Remote Data Facility is a business continuation process that enables effective, real-time data replication of SLDs between dislocated processing environments. These environments could be situated within the same root computer environment or separated by long distances.
SSE Agent	<i>(HP StorageWorks Disk Array XP specific term)</i> A Data Protector software module that executes all tasks required for a split mirror backup integration. It communicates with the HP StorageWorks Disk Array XP storing system using the RAID Manager XP utility (HP-UX and Windows systems) or RAID Manager Library (Solaris systems).
sst.conf file	The file <code>/usr/kernel/drv/sst.conf</code> is required on each Data Protector Sun Solaris client to which a multi-drive library device is connected. It must contain an entry for the SCSI address of the robotic mechanism of each library device connected to the client.
st.conf file	The file <code>/kernel/drv/st.conf</code> is required on each Data Protector Solaris client with a backup device connected. It must contain device information and a SCSI address for each backup drive connected to that client. A single SCSI entry is required

for a single-drive device and multiple SCSI entries are required for a multi-drive library device.

stackers	Devices with multiple slots for media storage usually with only one drive. A stacker selects media from the stack sequentially. In contrast, a library can randomly select media from its repository.
standalone file device	A file device is a file in a specified directory to which you back up data.
Storage Group	<i>(Microsoft Exchange Server specific term)</i> A collection of mailbox stores and public folder stores that share a set of transaction log files. Exchange Server manages each storage group with a separate server process.
StorageTek ACS library	<i>(StorageTek specific term)</i> Automated Cartridge System is a library system (also known as Silo) consisting of one Library Management Unit (LMU) and one to 24 Library Storage Modules (LSM) connected to the unit.
storage volume	<i>(ZDB specific term)</i> A storage volume represents an object that may be presented to an operating system or some other entity (for example, a virtualization mechanism) upon which volume management systems, file systems, or other objects may exist. The volume management systems, file systems are built on this storage. Typically, these can be created or exist within a storage system such as a disk array.
switchover	See failover .
Sybase Backup Server API	<i>(Sybase specific term)</i> An industry-standard interface developed for the exchange of backup and recovery information between a Sybase SQL Server and a backup solution like Data Protector.
Sybase SQL Server	<i>(Sybase specific term)</i> The server in the Sybase “client-server” architecture. Sybase SQL Server manages multiple databases and multiple users, keeps track of the actual location of data on disks, maintains mapping of logical data description to physical data storage, and maintains data and procedure caches in memory.
Symmetrix Agent (SYMA)	<i>(EMC Symmetrix specific term)</i> The Data Protector software module that prepares the EMC Symmetrix environment for backup and restore operations.

synthetic backup	A backup solution that produces a synthetic full backup, an equivalent to a conventional full backup in terms of data, without putting stress on the production servers or the network. A synthetic full backup is created from a previous full backup and any number of incremental backups.
synthetic full backup	The result of an object consolidation operation, where a restore chain of a backup objects is merged into a new, synthetic full version of this object. A synthetic full backup is equivalent to a conventional full backup in terms of restore speed.
System Backup to Tape	<i>(Oracle specific term)</i> An Oracle interface that handles the actions required to load, label, and unload correct backup devices when Oracle issues a backup or restore request.
system databases	<i>(Sybase specific term)</i> The four system databases on a newly installed Sybase SQL Server are the: <ul style="list-style-type: none"> • master database (master) • temporary database (tempdb) • system procedure database (sybprocedure) • model database (model).
System State	<i>(Windows specific term)</i> The System State data comprises the Registry, COM+ Class Registration database, system startup files, and the Certificate Services database (if the server is a certificate server). If the server is a domain controller, Active Directory services and the SYSVOL directory are also contained in the System State data. If the server is running the Cluster service, the System State data also includes resource registry checkpoints and the quorum resource recovery log, which contains the most recent cluster database information.
system volume/disk/partition	A volume/disk/partition containing operating system files. Microsoft terminology defines the system volume/disk/partition as the volume/disk/partition containing files required for the initial step of the boot process.
SysVol	<i>(Windows specific term)</i> A shared directory that stores the server copy of the domain's public files, which are replicated among all domain controllers in the domain.

tablespace	A part of a database structure. Each database is logically divided into one or more tablespaces. Each tablespace has data files or raw volumes exclusively associated with it.
tapeless backup (ZDB specific term)	See ZDB to disk .
target database	<i>(Oracle specific term)</i> In RMAN, the target database is the database that you are backing up or restoring.
target (R2) device	<i>(EMC Symmetrix specific term)</i> An EMC Symmetrix device that participates in SRDF operations with a source (R1) device. It resides in the remote EMC Symmetrix unit. It is paired with a source (R1) device in the local EMC Symmetrix unit and receives all write data from its mirrored pair. This device is not accessed by user applications during normal I/O operations. An R2 device must be assigned to an RDF2 group type. See also source (R1) device .
target system	<i>(Disaster Recovery specific term)</i> A system after a computer disaster has occurred. The target system is typically in a non-bootable state and the goal of disaster recovery is to restore this system to the original system configuration. The difference between a crashed system and a target system is that a target system has all faulty hardware replaced.
target volume	<i>(ZDB specific term)</i> A storage volume to which data is replicated.
Terminal Services	<i>(Windows specific term)</i> Windows Terminal Services provide a multi-session environment that allows clients to access a virtual Windows desktop session and Windows-based programs running on the server.
thread	<i>(Microsoft SQL Server specific term)</i> An executable entity that belongs to only one process. It comprises a program counter, a user-mode stack, a kernel-mode stack, and a set of register values. Several threads can run at a time within one process.
TimeFinder	<i>(EMC Symmetrix specific term)</i> A business continuation process that creates an instant copy of single or multiple Symmetrix Logical Devices (SLDs). The instant copy is created on specially preconfigured SLDs called BCVs and is accessible via a separate device address to the system(s).
TLU	Tape Library Unit.

TNSNAMES.ORA	<i>(Oracle and SAP R/3 specific term)</i> A network configuration file that contains connect descriptors mapped to service names. The file may be maintained centrally or locally, for use by all or individual clients.
transaction	A mechanism for ensuring that a set of actions is treated as a single unit of work. Databases use transactions to keep track of database changes.
transaction backup	Transaction backups generally use fewer resources than database backups, so they can be created more frequently than database backups. By applying transaction backups, you can recover the database to a specific point in time prior to when a problem occurred.
transaction backup	<i>(Sybase and SQL specific term)</i> A backup of the transaction log providing a record of changes made since the last full or transaction backup.
transaction log backup	Transaction log backups generally use fewer resources than database backups so they can be created more frequently than database backups. By applying transaction log backups, you can recover the database to a specific point in time.
transaction log files	Files that record transactions of the database modifications, and provide fault tolerance in case of a database disaster.
transaction logs	<i>(Data Protector specific term)</i> Keep track of IDB changes. The archiving of transaction logs should be enabled to prevent you from losing the transaction log files that are created after the last IDB backup and are necessary for IDB recovery.
transaction log table	<i>(Sybase specific term)</i> A system table in which all changes to the database are automatically recorded.
transportable snapshot	<i>(Microsoft VSS specific term)</i> A shadow copy that is created on the application system and can be presented to the backup system where a backup can be performed. See also Microsoft Volume Shadow Copy Service (VSS) .
TSANDS.CFG file	<i>(Novell NetWare specific term)</i> A file that allows you to specify the names of containers where you want backups to begin. It is a text file located in the <code>SYS:SYSTEM\TSA</code> directory on the server where <code>TSANDS.NLM</code> is loaded.

UIProxy	The Java GUI Server (<code>UIProxy</code> service) runs on the Data Protector Cell Manager. It is responsible for communication between the Java GUI Client and the Cell Manager, moreover, it performs business logic operations and sends only important information to the client. The service is started as soon as Data Protector is installed on the Cell Manager.
unattended operation	See lights-out operation .
user account (Data Protector user account)	You can use Data Protector only if you have a Data Protector user account, which restricts unauthorized access to Data Protector and to backed up data. Data Protector administrators create this account specifying a user logon name, the systems from which the user can log on, and a Data Protector user group membership. This is checked whenever the user starts the Data Protector user interface or performs specific tasks.
user disk quotas	NTFS quota-management support enables an enhanced tracking mechanism and control over disk space usage on shared storage volumes. Data Protector backs up user disk quotas on the whole system and for all configured users at a time.
user group	Each Data Protector user is member of a User Group. Each User Group has a set of user rights that are given to every user in that User Group. The number of User Groups with their associated user rights can be defined as desired. Data Protector provides three default user groups: admin, operator, and user.
user profile	<i>(Windows specific term)</i> Configuration information retained on a user basis. This information includes desktop settings, screen colors, network connections, and so on. When the user logs on, the user profile is loaded and the Windows environment is set accordingly.
user rights	User rights or access rights are the permissions needed to perform specific Data Protector tasks. Configuring a backup, starting a backup session, or starting a restore session are typical user rights. Users have the access rights of the user group to which they belong.
vaulting media	The process of storing media to a safe and remote place. The media are brought back to the data center when they are needed for restore or are ready for reuse in subsequent backups.

	The vaulting procedure depends on your company's backup strategy and policies for data protection/reliability.
verify	A function that lets you check whether the Data Protector data on a specified medium is readable. Additionally, consistency within each block can be checked if the backup was performed with the cyclic redundancy check (CRC) option ON.
Virtual Controller Software (VCS)	<i>(HP StorageWorks EVA specific term)</i> The firmware that manages all aspects of storage system operation, including communication with Command View EVA through the HSV controllers. See also Command View (CV) EVA .
Virtual Device Interface	<i>(Microsoft SQL Server specific term)</i> This is a SQL Server programming interface that allows fast backup and restore of large databases.
virtual disk	<i>(HP StorageWorks EVA specific term)</i> A unit of storage allocated from an HP StorageWorks Enterprise Virtual Array storage pool. Virtual disks are the entities that are replicated using the HP StorageWorks Enterprise Virtual Array snapshot functionality. See also source volume and target volume .
virtual full backup	An efficient type of synthetic backup where data is consolidated using pointers instead of being copied. It is performed if all the backups (the full backup, incremental backups, and the resulting virtual full backup) are written to a single file library that uses distributed file medium format.
Virtual Library System (VLS)	A disk-based data storage device hosting one or more virtual tape libraries (VTLs).
virtual server	A virtual machine in a cluster environment defined in a domain by a network IP name and address. Its address is cached by the cluster software and mapped to the cluster node that is currently running the virtual server resources. This way all requests for a particular virtual server are cached by a specific cluster node.
virtual tape	<i>(VLS specific term)</i> An archival storage technology that backs up data to disk drives in the same way as if it were being stored on tape. Benefits of virtual tape systems include improved backup and recovery speed and lower operating costs. See also Virtual Library System (VLS) and Virtual Tape Library .

Virtual Tape Library (VTL)	<i>(VLS specific term)</i> An emulated tape library that provides the functionality of traditional tape-based storage. See also Virtual Library System (VLS) .
volser	<i>(ADIC and STK specific term)</i> A VOLUME SERIAL number is a label on the medium to identify the physical tape used in very large libraries. A volser is a naming convention specific to ADIC/GRAU and StorageTek devices.
volume group	A unit of data storage in an LVM system. A volume group can consist of one or more physical volumes. There can be more than one volume group on the system.
volume mount point	<i>(Windows specific term)</i> An empty directory on a volume that can be used to mount another volume. The volume mount point acts as a gateway to the target volume. Provided that the volume is mounted, users and applications can refer to the data on the mounted volume by the full (merged) filesystem path as if both volumes are one integral part.
Volume Shadow Copy Service	See Microsoft Volume Shadow Copy Service .
VPO	See OM .
VSS	See Microsoft Volume Shadow Copy Service .
VSS compliant mode	<i>(HP StorageWorks Disk Array XP VSS provider specific term)</i> One of two XP VSS hardware provider operation modes. When the XP provider is in the VSS compliant mode, the source volume (P-VOL) and its replica (S-VOL) are in simplex, unpaired state after a backup. Therefore the number of replicas (S-VOLs per a P-VOL) rotated is not limited. Restore from a backup in such a configuration is possible only by switching of the disks. See also resync mode , source volume , primary volume (P-VOL) , replica , secondary volume (S-VOL) , and replica set rotation .
VxFS	Veritas Journal Filesystem.
VxVM (Veritas Volume Manager)	A Veritas Volume Manager is a system for managing disk space on Solaris platforms. A VxVM system consists of an arbitrary group of one or more physical volumes organized into logical disk groups.

Wake ONLAN	Remote power-up support for systems running in power-save mode from some other system on the same LAN.
Web reporting	The Data Protector functionality that allows you to view reports on backup, object copy, and object consolidation status and Data Protector configuration using the Web interface.
wildcard character	A keyboard character that can be used to represent one or many characters. The asterisk (*), for example, typically represents one or more characters, and the question mark (?) typically represents a single character. Wildcard characters are often used in operating systems as a means of specifying more than one file by name.
Windows CONFIGURATION backup	Data Protector allows you to back up Windows CONFIGURATION, including Windows Registry, user profiles, Event Logs, and WINS and DHCP server data (if configured on a system) in one step.
Windows Registry	A centralized database used by Windows to store configuration information for the operating system and the installed applications.
WINS server	A system running Windows Internet Name Service software that resolves Windows networking computer names to IP addresses. Data Protector can back up WINS server data as part of the Windows configuration.
writer	<i>(Microsoft VSS specific term)</i> A process that initiates change of data on the original volume. Writers are typically applications or system services that write persistent information on a volume. Writers also participate in the shadow copy synchronization process by assuring data consistency.
XBSA interface	<i>(Informix Server specific term)</i> ON-Bar and Data Protector communicate with each other through the X/Open Backup Services Application Programmer's Interface (XBSA).
XCopy engine	<i>(direct backup specific term)</i> A SCSI-3 copy command that allows you to copy data from a storage device having a SCSI source address to a backup device having a SCSI destination address, thus enabling direct backup. The data flows from a source device (either block or streaming, that is, disk or tape) to the destination device (either block or streaming) through XCopy. This releases

the controlling server of reading the data from the storage device into memory and then writing the information to the destination device.

See also [direct backup](#).

ZDB

See [zero downtime backup \(ZDB\)](#).

ZDB database

(ZDB specific term) A part of the IDB, storing ZDB related information such as source volumes, replicas and security information. The ZDB database is used for ZDB, instant recovery, and split mirror restore.

See also [zero downtime backup \(ZDB\)](#).

ZDB to disk

(ZDB specific term) A form of zero downtime backup where the replica produced is kept on the disk array as a backup of the source volumes at a specific point in time. Multiple replicas, produced using the same backup specification at different times, can be kept in a replica set. A replica from ZDB to disk can be restored using the instant recovery process.

See also [zero downtime backup \(ZDB\)](#), [ZDB to tape](#), [ZDB to disk+tape](#), [instant recovery](#), and [replica set rotation](#).

ZDB to disk+tape

(ZDB specific term) A form of zero downtime backup where the replica produced is kept on the disk array as a backup of the source volumes at a specific point in time, in the same way as with ZDB to disk. However, data in the replica is also streamed to a backup medium, as with ZDB to tape. If this backup method is used, data backed up in the same session can be restored using the instant recovery process, the standard Data Protector restore from tape, or on split mirror arrays, split mirror restore.

See also [zero downtime backup \(ZDB\)](#), [ZDB to disk](#), [ZDB to tape](#), [instant recovery](#), [replica](#), and [replica set rotation](#).

ZDB to tape

(ZDB specific term) A form of zero downtime backup where data in the replica produced is streamed to a backup medium, typically tape. Instant recovery is not possible from such a backup, so the replica need not be retained on the disk array after backup completion. The backed-up data can be restored using standard Data Protector restore from tape. On split mirror arrays, split mirror restore can also be used.

See also [zero downtime backup \(ZDB\)](#), [ZDB to disk](#), [instant recovery](#), [ZDB to disk+tape](#), and [replica](#).

zero downtime backup (ZDB)

A backup approach in which data replication techniques, provided by a disk array, are used to minimize the impact of backup operations on an application system. A replica of the data to be backed up is created first. All subsequent backup operations are performed on the replicated data rather than the original data, while the application system can be returned to normal operation.

See also [ZDB to disk](#), [ZDB to tape](#), [ZDB to disk+tape](#), and [instant recovery](#).

Index

Symbols

Cell Manager

troubleshooting, [52](#)

A

A.05.10, A.05.50, or A.06.00

migrating licenses, [362](#)

A.05.10, A.05.50, or A.06.00

licenses, [362](#)

access rights

adding to root account, on Linux, [105](#)

ACS Client, [118](#)

adding

access rights, on Linux, [105](#)

SCSI robotics driver to kernel, on
HP-UX, [411](#)

adding software components

overview, [245](#)

to HP-UX systems, [245](#)

adding software components

to Solaris systems, [247](#)

to Windows systems, [245](#)

ADIC library

See ADIC/GRAU library

ADIC/GRAU library

connecting drives, [119](#)

installing Media Agent to clients, [121](#)

Media Agent installation, [118](#)

preparing clients, [119](#)

AIX client

connecting backup devices, [111](#)

installing, [109](#)

allow_hosts file, [222](#), [224](#)

Application Recovery Manager

upgrading, [288](#)

audience, [19](#)

authorized systems list, security, [219](#)

AutoPass utility

installing, on UNIX, [47](#), [471](#)

installing, on Windows, [58](#)

licensing, [323](#)

uninstalling, on HP-UX, [236](#)

AutoPass utility

uninstalling, on Solaris, [240](#)

uninstalling, on Windows, [235](#)

B

backup devices

setting SCSI IDs, for HP

StorageWorks 330fx Library, [423](#)

- backup devices, connecting
 - ADIC/GRAU library drives, [119](#)
 - AIX clients, [111](#)
 - HP StorageWorks DAT 24 Tape Drive, [428](#)
 - HP StorageWorks DLT Library 24/48-Slot, [431](#)
 - HP Surestore 12000e Autoloader, [429](#)
 - HP-UX clients, [96](#)
 - Linux clients, [108](#)
 - overview, [424](#)
 - SCO clients, [117](#)
 - Seagate Viper 200 LTO Tape Drive, [436](#)
 - Siemens Sinix clients, [112](#)
 - Solaris clients, [102](#)
 - Tru64 clients, [115](#)
 - Windows clients, [91](#)
- backup environment concepts, [31](#)

C

- CD-ROM
 - installing from, [467](#)
 - installing from, [470](#)
 - list of installation CD-ROMs, [467](#)
- cell
 - concepts, [31](#)
 - enabling security, [222](#)
 - exporting clients, [213](#)
 - exporting Microsoft Cluster Server client, [215](#)
 - importing clients, [207](#)
 - importing Installation Server, [210](#)
 - importing clusters, [210](#)
 - licenses, [309](#)
 - securing clients, [220](#)
 - upgrading, overview, [250](#)
 - verifying DNS connections, [334](#)

- Cell Manager
 - Cell Request Server (CRS) service, [51](#)
 - functions, [37](#)
 - installing, on Microsoft Cluster Server, [191](#)
 - installing, on Solaris, [45](#)
 - Media Management Daemon (MMD) service, [51](#)
 - Raima Database Server (RDS) service, [51](#)
 - security concepts, [216](#)
 - troubleshooting, [337](#), [339](#)
 - uninstalling, from Linux, [242](#)
 - upgrading manually, on UNIX, [343](#)
- cell
 - licenses, [310](#)

- Cell Manager
 - automatically configured files, on UNIX, [49](#)
 - Cell Request Server (CRS) service, [59](#)
 - changing the name, [398](#)
 - changing software components, [245](#)
 - checking configuration changes, [264](#)
 - choosing the system, [37](#)
 - choosing the system, [38](#)
 - concepts, [31](#)
 - configuring for Veritas Volume Manager, on Microsoft Cluster Server, [443](#)
 - directory structure, on UNIX, [48](#)
 - installation prerequisites, on UNIX, [43](#)
 - installation prerequisites, on Windows, [52](#)
 - installation sequence, [42](#)
 - installing, on HP-UX, [45](#)
 - installing, on HP-UX, using native tools, [371](#)
 - installing, on Linux, using native tools, [375](#)
 - installing, on Solaris, using native tools, [373](#)
 - installing, on Windows, [52](#)
 - installing, on MC/ServiceGuard, [190](#)
 - preparing NIS server, [401](#)
 - Raima Database Server (RDS) service, [59](#)
 - setting environment variables, on UNIX, [51](#)
 - troubleshooting, [342](#), [343](#), [345](#)
 - troubleshooting installation, on UNIX, [52](#)
 - uninstalling, from Solaris, [239](#)
 - uninstalling, from HP-UX, [236](#)
 - uninstalling, from MC/ServiceGuard, [236](#)
 - uninstalling, from Windows, [234](#)
 - upgrading SSE, [287](#)
 - upgrading from Data Protector
 - A.05.10 and A.05.50, on HP-UX, [475](#)
 - upgrading from Data Protector A.05.10 and A.05.50, on HP-UX, [256](#)
 - upgrading from Data Protector A.05.10, A.05.50 and A.06.00, on HP-UX, [253](#)
 - upgrading from Windows NT to a newer Windows version, [289](#)
 - upgrading, on MC/ServiceGuard, [300](#)
 - upgrading, on Microsoft Cluster Server, [304](#)
- Cell Request Server (CRS) service, [51](#)
- Cell Request Server (CRS) service, [59](#)
- cell_info file, [248](#)
- changing
 - Cell Manager name, [398](#)
 - default port, [399](#)
 - software components, [245](#)
- checking
 - General Media Agent installation, on Novell NetWare, [438](#)
 - installation on clients, [341](#)
 - licenses, [309](#)
 - log files, installation, [343](#)
 - patches, [229](#)
 - TCP/IP setup, on Windows, [396](#)
- CLI
 - See command-line interface

client

- adding root access rights, on Linux, [105](#)
- changing software components, [245](#)
- checking TCP/IP setup, on Windows, [396](#)
- cluster-aware integration installation, overview, [154](#)
- cluster-aware, importing to a cell, [210](#)
- concepts, [31](#)
- configuring after installation, on Solaris, [98](#)
- configuring kernel, on Linux, [107](#)
- configuring for backup devices usage, on Solaris, [418](#)
- configuring for Veritas Volume Manager, on Microsoft Cluster Server, [443](#)
- configuring TCP/IP, on Windows, [392](#)
- creating device files, on Solaris, [421](#)
- creating device files, on HP-UX, [412](#)
- denying access from hosts, [224](#)
- enabling access verification, [220](#)
- exporting from a cell, [213](#)
- importing to a cell, [207](#)
- installation, overview, [69](#)
- integration installation, overview, [151](#)
- local installation, on Novell NetWare, [128](#)
- local installation, on OpenVMS, [135](#)
- Microsoft Cluster Server, exporting from a cell, [215](#)
- preparing for ADIC/GRAU library, [119](#)
- preparing for StorageTek ACS library, [125](#)
- remote installation, overview, [77](#)
- removing access verification, [223](#)
- securing, [220](#)
- security concepts, [216](#)
- troubleshooting, [337](#), [339](#), [341](#), [343](#), [345](#)
- uninstalling remotely, [232](#)

- upgrading from Data Protector A.05.10, A.05.50 and A.06.00, [266](#)
- upgrading from Data Protector A.05.10, A.05.50 and A.06.00, on MC/ServiceGuard, [267](#)
- upgrading, on Microsoft Cluster Server, [307](#)
- verifying installation, [341](#)

client, connecting backup devices

- ADIC/GRAU library drives, [119](#)

client, installing

- on AIX systems, [109](#)
- on HP-UX systems, [93](#)
- on Linux systems, [103](#)
- on MPE/iX systems, [142](#)
- on Novell NetWare Cluster Services systems, [203](#)
- on OpenVMS systems, [135](#)
- on SCO systems, [116](#)
- on Solaris systems, [96](#)
- on Tru64 systems, [114](#)
- on UNIX systems, [146](#)
- on Windows systems, [86](#)

client, connecting backup devices

- AIX clients, [111](#)
- HP-UX clients, [96](#)
- Linux clients, [108](#)
- SCO clients, [117](#)
- Siemens Sinix clients, [112](#)
- Solaris clients, [102](#)
- Tru64 clients, [115](#)
- Windows clients, [91](#)

- client, installing
 - DB2 integration, 158
 - HP StorageWorks Disk Array XP integration, 164
 - HP StorageWorks EVA integration, 176
 - HP StorageWorks VA integration, 170
 - IAP, 182
 - Informix integration, 155
 - Lotus integration, 159
 - Media Agent for ADIC/GRAU library, 121
 - Media Agent for StorageTek ACS library, 126
 - Microsoft Exchange integration, 154
 - Microsoft SharePoint Portal Server integration, 155
 - Microsoft Volume Shadow Copy integration, 159
 - Microsoft SQL integration, 155
 - NDMP integration, 158
 - NNM integration, 158
 - on MC/ServiceGuard systems, 191
 - on Microsoft Cluster Server systems, 199
 - on Novell NetWare systems, 128
 - on Siemens Sinix systems, 112
 - on Veritas Cluster systems, 202
 - Oracle integration, 157
 - SAP DB integration, 156
 - SAP R/3 integration, 156
 - Single Server Edition, 187
 - Sybase integration, 155
 - VLS, 183
 - Vmware integration, 157
- cluster
 - changing software components, 245
 - changing software components, 245
 - importing to a cell, 210
 - installing Cell Manager, 191
 - installing clients, 202, 203
 - installing clients, 199
 - installing integrations, 154
 - Microsoft Cluster Server, exporting from a cell, 215
 - uninstalling, 233
- command, 253, 319, 399
- command-line interface (CLI), 32
- command-line interface (CLI), 38
- commands
 - CLI changes, after upgrade, 447
 - infs, 413
 - ioscan, 410, 412, 415
 - netstat, 399
 - omnicc, 319
 - omnicheck, 231, 334
 - omnisetup.sh, 148, 186, 253, 475
 - omnisetup.sh , 256
 - omnisv, 253
- concepts
 - backup environment, 31
 - cell, 31
 - Cell Manager, 31
 - client, 31
 - Disk Agent, 32
 - exporting, 213
 - graphical user interface (GUI), 38
 - graphical user interface (GUI), 39
 - IDB filename conversion, 279
 - importing, 208
 - Installation Server, 31
 - Media Agent, 32
 - NDMP Media Agent, 32
 - remote installation, 34
 - User Interface, 32
- configuration files
 - changes, after upgrade, 444
 - inet.conf, 402

- configuration files
 - automatically configured files, on UNIX Cell Manager, [49](#)
 - cell_info, [248](#)
 - checking changes after upgrade from Data Protector A.05.10, A.05.50 and A.06.00, [264](#)
 - global, [264](#)
 - installation_servers, [64](#)
 - modifying, Solaris client installation, [98](#)
 - nsswitch.conf, [402](#)
 - omni_info, [248](#)
 - omnirc, [265](#)
 - sst.conf, [421](#)
 - st.conf, [418](#)
 - st.conf file, [98](#)
 - upgrade problems, [342](#)
 - configuring
 - Cell Manager with Veritas Volume Manager, on MSCS, [443](#)
 - clients with Veritas Volume Manager, on Microsoft Cluster Server, [443](#)
 - Disk Agent, on OpenVMS, [139](#)
 - kernel, on Linux clients, [107](#)
 - Media Agent, on Novell NetWare, [133](#)
 - Media Agent, on OpenVMS, [140](#)
 - SCSI robotics, on HP-UX, [408](#)
 - Solaris clients, before using backup devices, [418](#)
 - Solaris clients, after installation, [98](#)
 - sst.conf, [421](#)
 - st.conf file, [98](#)
 - st.conf, [418](#)
 - TCP/IP, on Windows, [392](#)
 - connecting backup devices
 - ADIC/GRAU library drives, [119](#)
 - AIX clients, [111](#)
 - HP StorageWorks DAT 24 Tape Drive, [428](#)
 - HP StorageWorks DLT Library 24/48-Slot, [431](#)
 - HP Surestore 12000e Autoloader, [429](#)
 - HP-UX clients, [96](#)
 - Linux clients, [108](#)
 - overview, [424](#)
 - SCO clients, [117](#)
 - Seagate Viper 200 LTO Tape Drive, [436](#)
 - Siemens Sinix clients, [112](#)
 - Solaris clients, [102](#)
 - Tru64 clients, [115](#)
 - Windows clients, [91](#)
 - conventions
 - document, [26](#)
 - conversion of filenames
 - See IDB filename conversion
 - creating
 - device files, on HP-UX, [412](#)
 - device files, on Solaris, [421](#)
 - device files, on Windows, [407](#)
 - execution trace files, installation, [345](#)
 - CRS
 - See Cell Request Server (CRS) service
- ## D
- DAS Client, [118](#)
 - database growth
 - See IDB
 - DB2 integration, installing, [158](#)
 - debug option
 - overview, [345](#)
 - debugging installation, [346](#)
 - default port, changing, [399](#)
 - default gateway, TCP/IP, [392](#)
 - deny_hosts file, [224](#)

- denying access from hosts, 224
- determining
 - installed licenses, 329
 - required licensing passwords, 321
 - unused SCSI addresses, on HP-UX, 415
 - unused SCSI addresses, on Solaris, 417
 - unused SCSI addresses, on Windows, 422
- device file
 - creating, on HP-UX, 412
- device file
 - creating, on Solaris, 421
 - creating, on Windows, 407
- disabling SCSI robotics drivers, on Windows, 404
- Disk Agent
 - concepts, 32
 - configuring, on OpenVMS, 139
- DNS
 - omnicheck command, 334
 - verifying connections in a cell, 334
- DNS check tool, 398
- document
 - conventions, 26
 - related documentation, 19
- documentation
 - HP website, 19
 - providing feedback, 29
- domain name system
 - See DNS
- drive licenses, 309
- DVD-ROM
 - list of installation DVD-ROMs, 35

E

- enabling access verification
 - on a client, 220
 - on a cell, 222
- environment variables, setting on UNIX Cell Manager, 51

- EVA integration
 - upgrading from Data Protector A.05.10 and A.05.50, 276
- excessive logging, 224
- execution trace files
 - creating, 346
 - debug option, 345
- exporting
 - clients, 214
 - Microsoft Cluster Server client, 215

F

- filenames
 - conversion
 - See IDB filename conversion
 - encoding
 - See IDB filename conversion
- files
 - allow_hosts, 222
 - HPDEVBRA.NLM, 442
 - allow_hosts, 223, 224
 - deny_hosts, 224
 - HPUMA.NLM, 442
 - services, 399
- Functional Extensions, licensing, 309

G

- General Media Agent
 - checking installation, on Novell NetWare, 438
- global file, 264
- graphical user interface (GUI)
 - concepts, 38
 - starting, UNIX, 38
- graphical user interface (GUI)
 - concepts, 39
 - views, 39
- GRAU library
 - See ADIC/GRAU library
- GUI
 - See graphical user interface

H

- help
 - obtaining, 28
- HP
 - technical support, 28
- HP StorageWorks 330fx Library, setting SCSI IDs, 423
- HP StorageWorks DAT 24 Tape Drive, connecting, 428
- HP StorageWorks Disk Array XP integration
 - installing, 164
- HP StorageWorks DLT Library 24/48-Slot, connecting, 431
- HP StorageWorks EVA integration
 - installing, 176
- HP StorageWorks VA integration
 - installing, 170
- HP Surestore 12000e Autoloader, connecting, 429
- HP-UX Cell Manager
 - installing, using native tools, 371
 - troubleshooting, 52
- HP-UX Cell Manager
 - automatically configured files, 49
 - directory structure, 48
 - installation prerequisites, 43
 - installing, 45
 - migrating from PA-RISC to IA-64, 290
 - setting environment variables, 51
 - troubleshooting, 342, 343
 - troubleshooting installation, 52
 - uninstalling, 236
 - upgrading from Data Protector A.05.10 and A.05.50, 256, 475
 - upgrading from Data Protector A.05.10, A.05.50 and A.06.00, 253
- HP-UX client
 - connecting backup devices, 96
 - installing, 93
 - troubleshooting, 339

- HP-UX Installation Server
 - installing, using native tools, 378
- HPDEVBRA.NLM file, 442
- HPUMA.NLMfile, 442

I

- IAP
 - prerequisites, 182
- IAP Server, importing, 209
- IDB
 - growth, 37
 - troubleshooting upgrade, 342
- IDB filename conversion
 - concepts, 279
- importing
 - clients, 207
 - clusters, 210
 - IAP Server, 209
 - Installation Server, 210
 - multiple LAN card clients, 209
 - NDMP clients, 209
 - OpenVMS clients, 209
 - VLS device, 209
- Inet service, 59
- inet.conf
 - file, 402
- inet.log file, 222, 224
- inet.logfile, 304
- Informix integration
 - upgrading from Data Protector A.05.10 and A.05.50, on UNIX, 271
 - upgrading from Data Protector A.05.10 and A.05.50, on Windows, 272
- Informix integration, installing, 155
- infscommand, 413

installation

- client installation, overview, [69](#)
 - cluster-aware integrations, [154](#)
 - components
 - See installation components
 - creating execution trace files, [346](#)
 - debugging, [346](#)
 - general steps, [33](#)
 - integrations, overview, [151](#)
 - log files, [343](#)
 - omnisetup.sh, [241](#)
 - overview, [31](#)
 - pkgadd utility, [240](#)
 - remote installation, overview, [77](#)
 - remote, concepts, [34](#)
 - software component codes, [148](#)
 - software components, [72](#)
 - troubleshooting clients, on UNIX, [339](#)
 - troubleshooting clients, on Windows, [341](#)
 - troubleshooting Cell Manager, on Solaris, [339](#)
 - troubleshooting, on Windows, [337](#)
 - verifying clients, [341](#)
- installation components
- Disk Agent, [32](#)
 - Installation Server, [31](#)
- Installation Server
- installation sequence, [42](#)
- installation components
- General Media Agent, [32](#)
 - Media Agent, [32](#)
 - NDMP Media Agent, [32](#)
 - User Interface, [32](#)

Installation Server

- concepts, [31](#)
 - directory structure, on UNIX, [48](#)
 - importing to a cell, [210](#)
 - installation prerequisites, on UNIX, [61](#)
 - installation prerequisites, on Windows, [65](#)
 - installation overview, [61](#)
 - installing, on HP-UX, using native tools, [378](#)
 - installing, on Linux, using native tools, [383](#)
 - installing, on Solaris, using native tools, [379](#)
 - installing, on UNIX, [61](#)
 - installing, on Windows, [65](#)
 - uninstalling, from MC/ServiceGuard, [236](#)
 - uninstalling, from UNIX, [240](#)
 - uninstalling, from HP-UX, [236](#)
 - uninstalling, from Linux, [243](#)
 - uninstalling, from Windows, [234](#)
 - upgrading manually, on UNIX, [343](#)
 - upgrading from Data Protector A.05.10, A.05.50 and A.06.00, on HP-UX, [253](#)
- Installation Server A.05.10, A.05.50 and A.06.00, on Windows
- upgrading from Data Protector, [259](#)
- installation_servers file, [64](#)

installing

- AutoPass utility, on UNIX, [47](#), [471](#)
- AutoPass utility, on Windows, [58](#)
- clients locally, [142](#), [146](#)
- clients locally, [86](#), [135](#)
- cluster-aware Cell Manager, [190](#)
- cluster-aware Cell Manager, [191](#)
- cluster-aware clients, [191](#), [199](#), [202](#), [203](#)
- DB2 integration, [158](#)
- HP StorageWorks Disk Array XP integration, [164](#)
- HP StorageWorks EVA integration, [176](#)
- HP StorageWorks VA integration, [170](#)
- IAP components, [182](#)
- Informix integration, [155](#)
- integrations, [151](#)
- localized user interface, [184](#)
- Lotus integration, [159](#)
- Media Agent for ADIC/GRAU library, [118](#)
- Media Agent for ADIC/GRAU library, [121](#)
- Media Agent for StorageTek ACS library, [118](#), [126](#)
- Microsoft Exchange integration, [154](#)
- Microsoft SharePoint Portal Server integration, [155](#)
- Microsoft SQL integration, [155](#)
- Microsoft Volume Shadow Copy integration, [159](#)
- NDMP integration, [158](#)
- NNM integration, [158](#)
- Oracle integration, [157](#)
- permanent licensing passwords, [323](#), [329](#)
- SAP DB integration, [156](#)
- SAP R/3 integration, [156](#)
- Single Server Edition, [187](#)
- Sybase integration, [155](#)
- VLS automigration, [183](#)
- VMware integration, [157](#)
- Web Reporting, [189](#)

installing Cell Manager

- on HP-UX systems, [45](#)
- on Linux systems, [45](#)

installing Installation Server

- on UNIX systems, [61](#)
- on Windows systems, [65](#)
- prerequisites, on UNIX, [61](#)
- prerequisites, on Windows, [65](#)

installing Cell Manager

- on Windows systems, [52](#)
- on HP-UX systems using native tools, [371](#)
- on Linux systems using native tools, [375](#)
- on MC/ServiceGuard systems, [190](#)
- on Microsoft Cluster Server systems, [191](#)
- on Solaris systems, [45](#)
- on Solaris systems using native tools, [373](#)
- prerequisites, on UNIX, [43](#)
- prerequisites, on Windows, [52](#)

installing clients

- on AIX systems, [109](#)
- on HP-UX systems, [93](#)
- on Linux systems, [103](#)
- on MC/ServiceGuard systems, [191](#)
- on Microsoft Cluster Server systems, [199](#)
- on MPE/iX systems, [142](#)
- on Novell NetWare Cluster Services systems, [203](#)
- on Novell NetWare systems, [128](#)
- on OpenVMS system, [135](#)
- on SCO systems, [116](#)
- on Siemens Sinix systems, [112](#)
- on Solaris systems, [96](#)
- on Tru64 systems, [114](#)
- on UNIX systems, [146](#)
- on Veritas Cluster systems, [202](#)
- on Windows systems, [86](#)

installing Installation Server

- overview, [61](#)

- installing Installation Server
 - on HP-UX systems, using native tools, [378](#)
 - on Linux systems, using native tools, [383](#)
 - on Solaris systems, using native tools, [379](#)
- Integrated Archive Platform (IAP)
 - installing, [182](#)
- integration client, [151](#)
 - See also* integrations
- integrations
 - cluster-aware installation, [154](#)
 - EVA, [276](#)
 - local installation, [153](#)
 - Oracle, on UNIX, [268](#)
 - overview, [151](#)
 - remote installation, [153](#)
 - SAP R/3, on UNIX, [270](#)
 - upgrading EVA, [276](#)
 - upgrading Informix, on UNIX, [271](#)
 - upgrading Oracle, on Windows, [268](#)
 - upgrading SAP R/3, on Windows, [270](#)
 - upgrading Informix, on Windows, [272](#)
 - upgrading Sybase, on UNIX, [274](#)
 - upgrading Sybase, on Windows, [275](#)

- integrations, installing
 - DB2 integration, [158](#)
 - HP StorageWorks Disk Array XP integration, [164](#)
 - HP StorageWorks EVA integration, [176](#)
 - HP StorageWorks VA integration, [170](#)
 - Informix integration, [155](#)
 - Lotus integration, [159](#)
 - Microsoft Exchange integration, [154](#)
 - Microsoft SharePoint Portal Server integration, [155](#)
 - Microsoft SQL integration, [155](#)
 - Microsoft Volume Shadow Copy integration, [159](#)
 - NDMP integration, [158](#)
 - NNM integration, [158](#)
 - Oracle integration, [157](#)
 - SAP DB integration, [156](#)
 - SAP R/3 integration, [156](#)
 - Sybase integration, [155](#)
 - VMware integration, [157](#)
- internationalization, IDB, [279](#)
- ioscan command, [415](#)
- ioscancommand, [410](#), [412](#)
- IP address, TCP/IP, [392](#)

K

- kernel
 - adding SCSI robotics driver, on HP-UX, [411](#)
 - configuring on Linux clients, [107](#)
 - rebuilding, on HP-UX, [411](#)

L

- license-to-use., [320](#)
- licenses, [320](#)

- licensing
 - AutoPass utility, 323
 - capacity based licenses, 311
 - capacity based licensing, examples, 315
 - capacity based licensing, examples, 319
 - Cell Manager, 310
 - centralized licensing, configuring, 331
 - checking and reporting licenses, 309
 - determining installed licenses, 329
 - determining required passwords, 321
 - Drive Extensions, 350
 - drive licenses, 309
 - emergency passwords, 323
 - entity based licenses, 310
 - Functional Extensions, 352
 - Functional Extensions, 309
 - Instant-On passwords, 322
 - license migration, 362
 - licensing forms, 367
 - migrating Data Protector, 362
 - moving licenses, 330
 - obtaining and installing permanent passwords, 323, 329
 - overview, 320
 - password types, 322
 - permanent passwords, 323
 - permanent passwords, obtaining and installing, 323, 329
 - producing license reports, 319
 - product structure, 309, 347
 - product licensing overview, 321
 - product overview, 348
 - product structure, 309
 - Single Server Edition, 360
 - Starter Packs, 309
 - upgrade from Data Protector A.05.10, A.05.50, and A.06.00, 252
 - upgrade from SSE, 286
 - using licenses, after upgrade, 286
 - using licenses, after upgrade, 252
 - verifying passwords, 329
- licensing forms, 367
- limitations
 - on Windows systems, 65, 87
 - Single Server Edition, 188
 - upgrade, 250
 - upgrade of Manager-of-Managers, 251
- Linux Cell Manager
 - installing, using native tools, 375
 - troubleshooting, 52
 - troubleshooting installation, 52
- Linux Cell Manager
 - automatically configured files, 50
 - directory structure, 48
 - installation prerequisites, 43
 - installing, 45
 - setting environment variables, 51
 - uninstalling, 242
- Linux client
 - configuring kernel, 107
 - connecting backup devices, 108
 - installing, 103
 - troubleshooting remote installation, 105
- Linux Installation Server
 - installing, using native tools, 383
- local installation, clients, 86
- local installation, clients, 135, 142, 146
- localized user interface, 184
 - See also User Interface
- log files
 - checking, installation, 343
- log files
 - description, 345
 - inet.log, 222, 224, 304
 - location, 344
- Lotus integration, installing, 159
- LTU, 320

M

- Manager-of-Managers
 - upgrade overview, 251
 - upgrading from Data Protector A.05.10 and A.05.50, 278
- MC/ServiceGuard
 - excessive logging to inet.log file, 224
 - importing, 212
 - installing Cell Manager, 190
 - installing clients, 191
 - uninstalling Cell Manager, 236
 - uninstalling Installation Server, 236
 - upgrading Cell Manager, 300
 - upgrading clients from Data Protector A.05.10, A.05.50 and A.06.00, 267
- Media Agent
 - concepts, 32
 - configuring, on Novell NetWare, 133
 - configuring, on OpenVMS, 140
 - installing for ADIC/GRAU library, 121
 - installing for StorageTek ACS library, 126
 - types, 32
- Media Management Daemon (MMD) service, 51
- Microsoft Cluster Server
 - upgrading Cell Manager, 304
- Microsoft SharePoint Portal Server integration
 - installing, 155
- Microsoft Cluster Server
 - configuring Cell Manager with Veritas Volume Manager, 443
 - configuring clients with Veritas Volume Manager, 443
 - exporting, 215
 - importing, 211
 - installing Cell Manager, 191
 - installing clients, 199
 - upgrading clients, 307
- Microsoft Exchange integration
 - installing on systems with HP StorageWorks EVA, 181
- Microsoft Exchange integration
 - installing, 154
 - installing on systems with HP StorageWorks Disk Array XP, 169
 - installing on systems with HP StorageWorks VA, 175
- Microsoft Installer, 53, 250, 304, 337
- Microsoft SQL integration
 - installing, 155
 - installing on systems with EMC Symmetrix disk array, 164
 - installing on systems with HP StorageWorks Disk Array XP, 170
 - installing on systems with HP StorageWorks EVA, 182
 - installing on systems with HP StorageWorks VA, 176
- Microsoft Terminal Services Client, 53
- Microsoft Volume Shadow Copy integration, installing, 159
- Migrating
 - Cell Manager on HP-UX, PA-RISC to IA-64, 290
 - Cell Manager on Windows, 32-bit to 64-bit, 295
- migrating
 - licenses, 362
- minimizing network traffic, on Novell NetWare clients, 133
- MMD
 - See Media Management Daemon (MMD) service
- moving licenses, 330
- MPE/iX client, installing, 142
- MSI.
 - See Microsoft Installer
- multibyte characters, 279
- multiple LAN card client, importing, 209

N

- NDMP client, importing, [209](#)
- NDMP integration, installing, [158](#)
- NDMP Media Agent, concepts, [32](#)
- netstat, [399](#)
- NIS server, preparing, [401](#)
- NNM integration, installing, [158](#)
- Novell NetWare client
 - checking General Media Agent installation, [438](#)
 - configuring Media Agent, [133](#)
 - HPDEVBRA.NLM file, [442](#)
 - HPUMA.NLM file, [442](#)
 - installing, [128](#)
 - minimizing network traffic, [133](#)
- Novell NetWare Cluster Services
 - importing, [212](#)
 - installing clients, [203](#)
 - limitations, failover, [203](#)
- nsswitch.conf
 - file, [402](#)
- nsswitch.conf file, [402](#)

O

- obtaining permanent licensing
- passwords, [323](#), [329](#)
- omni_info file, [248](#)
- omnicc, [319](#)
- omnicheck command, [231](#), [334](#)
- omniinet process
 - See Inet service
- omnirc file, [265](#)
- omnisetup.sh, [241](#)
- omnisetup.sh command
 - installation, [148](#), [186](#)
 - upgrade, [253](#), [256](#), [475](#)
- omnisv command, [253](#)

- OpenVMS client
 - configuring Disk Agent, [139](#)
 - configuring Media Agent, [140](#)
 - importing, [209](#)
 - uninstalling, [233](#)
- operating system
 - upgrading Windows NT to a newer Windows version, [289](#)
- Oracle integration
 - installing, [157](#)
 - installing on systems with EMC Symmetrix disk array, [160](#)
 - installing on systems with HP StorageWorks Disk Array XP, [165](#)
 - installing on systems with HP StorageWorks EVA, [177](#)
 - installing on systems with HP StorageWorks VA, [171](#)
 - uninstallation specifics, [247](#)
 - upgrading from Data Protector A.05.10 and A.05.50, [268](#)

overview

- changing software components, [245](#)
- connecting backup devices, [424](#)
- debug option, [345](#)
- execution trace files, [345](#)
- importing cluster-aware client, [210](#)
- importing application cluster packages, [210](#)
- installing Installation Server, [61](#)
- installing clients, [69](#)
- installing cluster-aware integrations, [154](#)
- installing integrations, [151](#)
- integrations, [151](#)
- licensing, [320](#)
- product structure, [309](#)
- remotely installing clients, [77](#)
- software components, [72](#)
- uninstallation, [231](#)
- upgrade, [249](#)
- upgrading from Data Protector A.05.10, A.05.50, and A.06.00, [252](#)

P

patches

- omnicheck command, [231](#)
 - verifying, [229](#)
- pkgadd utility, [240](#)
- pkgrm utility, [239](#)
- preparing NIS server, [401](#)

prerequisites

- Cell Manager installation, on UNIX, [43](#)
- Cell Manager installation, on Windows, [52](#)
- IAP, [182](#)
- Installation Server installation, on UNIX, [61](#)
- Installation Server installation, on Windows, [65](#)
- upgrade from Data Protector A.05.10, A.05.50 and A.06.00, [253](#)
- VLS automigration, [184](#)

processes

- Cell Request Server (CRS) service, [59](#)
- Cell Request Server (CRS) service, [51](#)
- Inet service, [59](#)
- Media Management Daemon (MMD) service, [51](#)
- Raima Database Server (RDS) service, [59](#)
- Raima Database Server (RDS) service, [51](#)

R

Raima Database Server (RDS) service, [51](#)

Raima Database Server (RDS) service, [59](#)

RDS

See Raima Database Server (RDS) service

rebuilding kernel, on HP-UX, [411](#)

related licenses, [310](#)

related documentation, [19](#)

remote installation

integrations, [153](#)

troubleshooting, on Linux, [105](#)

remote installation

clients, [77](#)

- removing
 - access verification on a client, [223](#)
 - Data Protector software manually, from UNIX, [244](#)
 - software components, from UNIX, [246](#)
 - software components, from Windows, [245](#)
 - software components, overview, [245](#)
 - software components, from UNIX, [247](#)
- reporting licenses, [309](#)
- robotics.
 - See SCSI interface
- robotics.
 - See SCSI interface
- rpm utility, [241](#)

S

- SAP DB integration, installing, [156](#)
- SAP R/3 integration
 - installing, [156](#)
 - installing on systems with EMC Symmetrix disk array, [161](#)
 - installing on systems with HP StorageWorks Disk Array XP, [166](#)
 - installing on systems with HP StorageWorks EVA, [178](#)
 - installing on systems with HP StorageWorks VA, [172](#)
 - upgrading from Data Protector A.05.10 and A.05.50, [270](#)
- SCO client
 - connecting backup devices, [117](#)
 - installing, [116](#)
- SCSI robotics.
 - See SCSI interface
- SCSI addresses.
 - See SCSI interface
- SCSI controller.
 - See SCSI interface
- SCSI interface
 - adding robotics driver to kernel, on HP-UX, [411](#)
 - configuring robotics, on HP-UX, [408](#)
 - determining unused addresses, on HP-UX, [415](#)
 - determining unused addresses, on Solaris, [417](#)
 - determining unused addresses, on Windows, [422](#)
 - disabling robotics drivers, on Windows, [404](#)
 - setting controller parameters, on Windows, [415](#)
 - setting IDs, for HP StorageWorks 330fx Library, [423](#)
 - using tape drivers, on Windows, [403](#)
- SCSI tape drivers.
 - See SCSI interface
- Seagate Viper 200 LTO Tape Drive, connecting, [436](#)
- securing
 - cell, [222](#)
 - client, [220](#)
- security
 - allow_hosts file, [222](#), [224](#)
 - deny_hosts file, [224](#)
 - denying access from hosts, [224](#)
 - enabling security for a cell, [222](#)
 - enabling security for a client, [220](#)
 - excessive logging to inet.log file, [224](#)
 - list of authorized systems, [219](#)
 - potential problems, [219](#)
 - removing access verification on a client, [223](#)
- servicesfile, [399](#)
- setting
 - environment variables, on UNIX Cell Manager, [51](#)
 - SCSI IDs, for HP StorageWorks 330fx Library, [423](#)
 - SCSI controller parameters, on Windows, [415](#)

- Siemens Sinix client
 - connecting backup devices, 112
 - installing, 112
- Single Server Edition
 - installing, 187
 - upgrading to Data Protector A.06.10, 286
- Single Server Edition
 - license types, 360
 - limitations, 188
 - product overview, licenses, 348
 - upgrading from multiple installations, 287
 - upgrading to Data Protector A.06.10, 286
- software components
 - dependencies, on HP-UX, 246
 - removing, from Windows, 245
- software components
 - adding, to HP-UX, 245
 - adding, to Windows, 245
 - adding, to Solaris, 247
 - changing, on cluster clients, 245
 - changing, overview, 245
 - component codes, 148
 - dependencies, on Solaris, 247
 - overview, 72
 - removing, from UNIX, 247
 - removing, from UNIX, 246
- Solaris Cell Manager
 - installation prerequisites, 43
 - installing, using native tools, 373
 - troubleshooting, 342
- Solaris client
 - troubleshooting, 339
- Solaris Cell Manager
 - automatically configured files, 50
 - directory structure, 48
 - installing, 45
 - setting environment variables, 51
 - troubleshooting, 339, 343
 - troubleshooting installation, 52
 - uninstalling, 239
- Solaris client
 - configuring, after installation, 98
 - connecting backup devices, 102
 - installing, 96
- Solaris Installation Server
 - installing, using native tools, 379
- SSE, 286
- SSE.
 - See Single Server Edition
- sst.conf file, 421
- st.conf file, 98
- st.conf file, 418
- Starter Packs, licensing, 309
- starting
 - GUI, UNIX, 38
- STK ACS
 - See StorageTek ACS library
- StorageTek ACS library
 - connecting drives, 119
- StorageTek ACS library
 - installing Media Agent to clients, 126
 - Media Agent installation, 118
 - preparing clients, 125
- StorageTek library
 - See StorageTek ACS library
- subnet mask, TCP/IP, 392
- Subscriber's Choice, HP, 29
- swagent daemon, 340
- Sybase integration
 - upgrading from Data Protector A.05.10 and A.05.50, on UNIX, 274
 - upgrading from Data Protector A.05.10 and A.05.50, on Windows, 275
- Sybase integration, installing, 155

T

- tape drivers.
 - See SCSI interface

- TCP/IP
 - checking setup, on Windows, [396](#)
 - configuring, on Windows, [392](#)
 - default gateway, [392](#)
 - IP address, [392](#)
 - subnet mask, [392](#)
- technical support
 - HP, [28](#)
- technical support
 - service locator website, [29](#)
- Terminal Services Client, [53](#)
- trace files.
 - See execution trace files
- troubleshooting installation
 - execution trace files, [345](#)
- troubleshooting upgrade
 - configuration files not available, [342](#)
 - IDB not available, [342](#)
- troubleshooting installation
 - Cell Manager, on Solaris, [339](#)
 - Cell Manager, on UNIX, [52](#)
 - Cell Manager, on Windows, [60](#)
 - clients, on HP-UX, [340](#)
 - Data Protector software, on Windows, [337](#)
 - debug option, [345](#)
 - debugging, [346](#)
 - localized user interface, [187](#)
 - log files, [343](#)
 - Microsoft Installer problems, [337](#)
 - omnicheck command, [334](#)
 - remote installation, on Linux, [105](#)
 - remote installation, on UNIX, [339](#)
 - remote installation, on Windows, [341](#)
 - swagent daemon, [340](#)
- troubleshooting localized user interface, [187](#)
- troubleshooting upgrade
 - Data Protector software, on Windows, [337](#)
 - Data Protector patches, [342](#)
 - Microsoft Installer problems, [337](#)

- Tru64 client
 - connecting backup devices, [115](#)
 - installing, [114](#)
- type the TCP/IP name of the OpenVMS client in the Name text box., [209](#)

U

- uninstallation
 - Oracle integration specifics, [247](#)
 - overview, [231](#)
 - pkgm utility, [239](#)
 - prerequisites, [232](#)
 - rpm utility, [241](#)
- uninstalling
 - AutoPass utility, on HP-UX, [236](#)
 - AutoPass utility, on Solaris, [240](#)
 - AutoPass utility, on Windows, [235](#)
 - Cell Manager, from HP-UX, [236](#)
 - Cell Manager, from Windows, [234](#)
 - Cell Manager, from Linux, [242](#)
 - Cell Manager, from MC/ServiceGuard, [236](#)
 - Cell Manager, from Solaris, [239](#)
 - clients, from OpenVMS, [233](#)
 - clients, remotely, [232](#)
 - cluster clients, [233](#)
 - Installation Server, from Linux, [243](#)
 - Installation Server, from MC/ServiceGuard, [236](#)
 - Installation Server, from HP-UX, [236](#)
 - Installation Server, from UNIX, [240](#)
 - Installation Server, from Windows, [234](#)
- unused SCSI addresses.
 - See SCSI interface

- upgrade
 - before upgrading, [249](#)
 - CLI changes, [447](#)
 - configuration files changes, [444](#)
 - global file , [264](#)
 - limitations, [250](#)
 - omnirc file, [265](#)
 - omnisetup.sh, [253](#)
 - omnisetup.sh command, [256](#)
 - omnisetup.shcommand, [475](#)
 - omnisv command, [253](#)
 - overview, [249](#)
 - sequence, [250](#)
 - troubleshooting IDB, [342](#)
 - troubleshooting, on UNIX, [342](#)
 - troubleshooting, on Windows, [337](#)
 - troubleshooting, on Windows, [342](#)
- upgrading
 - Application Primary Manager, [288](#)
 - manually, on UNIX, [343](#)
 - SSE to Data Protector A.06.10, [286](#), [286](#)
 - Windows NT to a newer Windows version, [289](#)
- upgrading from Data Protector A.05.10, A.05.50 and A.06.00
 - Installation Server on Windows, [259](#)
- upgrading from Data Protector A.05.10, A.05.50 and A.06.00
 - clients, [266](#)
 - clients, on MC/ServiceGuard, [267](#)
- upgrading from Data Protector, [362](#)
- upgrading from Data Protector A.05.10 and A.05.50
 - Manager-of-Managers, [278](#)
- upgrading from Data Protector A.05.10, A.05.50, and A.06.00
 - clients, on Microsoft Cluster Server, [307](#)
- upgrading from Data Protector A.05.10 and A.05.50
 - Informix integration, on Windows, [272](#)
 - Sybase integration, on Windows, [275](#)
- upgrading from Data Protector A.05.10 and A.05.50
 - Cell Manager, on HP-UX, [256](#), [475](#)
 - EVA integration, [276](#)
 - Informix integration, on UNIX, [271](#)
 - Oracle integration, [268](#)
 - SAP R/3 integration, [270](#)
 - Sybase integration, on UNIX, [274](#)
- upgrading from Data Protector A.05.10, A.05.50 and A.06.00
 - omnisv command, [253](#)
- upgrading from Data Protector A.05.10, A.05.50 and A.06.00
 - Cell Manager, on HP-UX, [253](#)
 - checking configuration changes, [264](#)
 - Installation Server, on HP-UX, [253](#)
- upgrading from Data Protector A.05.10, A.05.50 and A.06.00
 - prerequisites, [253](#)
- upgrading from Data Protector A.05.10, A.05.50, and A.06.00
 - Cell Manager , on Microsoft Cluster Server, [304](#)
 - Cell Manager, on MC/ServiceGuard, [300](#)
 - overview, [252](#)
- Upgrading to HP-UX 11.23, [290](#)
- User Interface
 - installing localized user interface, [184](#)
- User Interface
 - choosing the system, [38](#)
 - concepts, [32](#)
 - troubleshooting localized user interface installation, [187](#)
- user interface
 - See command-line interface (CLI), graphical user interface (GUI)

- using
 - licenses, 249, 252
 - log files, 343
 - SCSI tape drivers, on Windows, 403

V

- verifying
 - client installation, 341
 - DNS connections in a cell, 334
 - licensing passwords, 329
 - patches, 229
- Veritas Cluster
 - importing, 212
 - installing clients, 202
 - limitations, failover, 202
- Veritas Volume Manager
 - configuring Cell Manager, on Microsoft Cluster Server, 443
 - configuring clients, on Microsoft Cluster Server, 443
- views, graphical user interface, 39
- virtual server, importing to a cell, 210
- VLS Automigration
 - installing, 183
- VLS automigration
 - prerequisites, 184
- VLS device, importing, 209
- VMware integration
 - installing, 157

W

- Web Reporting, installing, 189
- websites
 - HP Subscriber's Choice for Business, 29
 - HP, 29
 - product manuals, 19
- Windows Cell Manager
 - installing, 52

- Windows Cell Manager
 - installation prerequisites, 52
 - migrating from 32-bit to 64-bit, 295
 - troubleshooting, 337, 342
 - troubleshooting installation, 60
 - uninstalling, 234
- Windows client
 - connecting backup devices, 91
 - installing, 86
 - troubleshooting, 337, 341, 343
 - uninstalling, 232
- Windows NT, upgrading to a newer Windows version, 289

Z

- ZDB integration client, 151
 - See also integrations