

**Oracle® SQL\*Module for Ada**

Programmer's Guide

Release 8.0

**Part No. A58231-03**

December 2003

Oracle SQL\*Module for Ada Programmer's Guide, Release 8.0

Part No. A58231-03

Copyright © 1997, 2003, Oracle. All rights reserved.

The Programs (which include both the software and documentation) contain proprietary information; they are provided under a license agreement containing restrictions on use and disclosure and are also protected by copyright, patent, and other intellectual and industrial property laws. Reverse engineering, disassembly, or decompilation of the Programs, except to the extent required to obtain interoperability with other independently created software or as specified by law, is prohibited.

The information contained in this document is subject to change without notice. If you find any problems in the documentation, please report them to us in writing. This document is not warranted to be error-free. Except as may be expressly permitted in your license agreement for these Programs, no part of these Programs may be reproduced or transmitted in any form or by any means, electronic or mechanical, for any purpose.

If the Programs are delivered to the United States Government or anyone licensing or using the Programs on behalf of the United States Government, the following notice is applicable:

U.S. GOVERNMENT RIGHTS Programs, software, databases, and related documentation and technical data delivered to U.S. Government customers are "commercial computer software" or "commercial technical data" pursuant to the applicable Federal Acquisition Regulation and agency-specific supplemental regulations. As such, use, duplication, disclosure, modification, and adaptation of the Programs, including documentation and technical data, shall be subject to the licensing restrictions set forth in the applicable Oracle license agreement, and, to the extent applicable, the additional rights set forth in FAR 52.227-19, Commercial Computer Software--Restricted Rights (June 1987). Oracle Corporation, 500 Oracle Parkway, Redwood City, CA 94065

The Programs are not intended for use in any nuclear, aviation, mass transit, medical, or other inherently dangerous applications. It shall be the licensee's responsibility to take all appropriate fail-safe, backup, redundancy and other measures to ensure the safe use of such applications if the Programs are used for such purposes, and we disclaim liability for any damages caused by such use of the Programs.

Oracle is a registered trademark of Oracle Corporation and/or its affiliates. Other names may be trademarks of their respective owners.

The Programs may provide links to Web sites and access to content, products, and services from third parties. Oracle is not responsible for the availability of, or any content provided on, third-party Web sites. You bear all risks associated with the use of such content. If you choose to purchase any products or services from a third party, the relationship is directly between you and the third party. Oracle is not responsible for: (a) the quality of third-party products or services; or (b) fulfilling any of the terms of the agreement with the third party, including delivery of products or services and warranty obligations related to purchased products or services. Oracle is not responsible for any loss or damage of any sort that you may incur from dealing with any third party.

---

---

# Contents

<b>Send Us Your Comments</b> .....	ix
<b>Preface</b> .....	xi
Intended Audience .....	xi
Documentation Accessibility .....	xi
Standards Conformance .....	xii
Structure.....	xii
Related Documents .....	xiii
Conventions .....	xiv
<b>1 Introduction to SQL*Module</b>	
<b>What Is SQL*Module?</b> .....	1-1
Background .....	1-1
Precompilers .....	1-2
The Module Language Concept.....	1-3
<b>SQL*Module as an Interface Builder</b> .....	1-6
<b>What Is Supported by SQL*Module?</b> .....	1-7
<b>What SQL Statements are Not Supported by SQL*Module?</b> .....	1-8
<b>2 Module Language</b>	
<b>The Module</b> .....	2-1
An Example Module.....	2-1
A Short Example Program in Ada.....	2-3
<b>Structure of a Module</b> .....	2-6
Preamble .....	2-6
MODULE Clause .....	2-6
LANGUAGE Clause.....	2-6
AUTHORIZATION Clause .....	2-6
Cursor Declarations .....	2-7
Procedure Definitions.....	2-8
Procedure Name.....	2-8
Parameter List.....	2-8
SQL92 Syntax .....	2-8
<b>SQL Datatypes</b> .....	2-9
<b>SQL Commands</b> .....	2-10

Text in a Module .....	2-11
Comments .....	2-11
<b>Indicator Parameters</b> .....	2-11
<b>Status Parameters</b> .....	2-13
Error Messages .....	2-13
<b>CONNECT Statement</b> .....	2-13
SET CONNECTION Statement.....	2-14
<b>DISCONNECT Statement</b> .....	2-14
<b>Multi-tasking</b> .....	2-15
ENABLE THREADS .....	2-15
SQL_CONTEXT Datatype .....	2-15
CONTEXT ALLOCATE .....	2-16
CONTEXT FREE.....	2-16
Multi-tasking Restrictions.....	2-16
<b>Multi-tasking Example</b> .....	2-16

### 3 Accessing Stored Procedures

PL/SQL.....	3-1
Procedures.....	3-2
<b>Stored Procedures</b> .....	3-2
<b>Stored Packages</b> .....	3-3
<b>Accessing Stored Procedures</b> .....	3-3
<b>Case of Package and Procedure Names</b> .....	3-4
<b>Early and Late Binding</b> .....	3-5
<b>Cursor Variables</b> .....	3-7
Cursor Variable Parameters.....	3-7
Allocating a Cursor Variable .....	3-7
Opening a Cursor Variable .....	3-7
Opening in a Stand-alone Stored Procedure.....	3-8
Return Types.....	3-9
Closing a Cursor Variable .....	3-9
Restrictions on Cursor Variables .....	3-9
<b>Dynamic SQL</b> .....	3-9
<b>The WITH INTERFACE Clause</b> .....	3-9
Examples .....	3-10
SQL Datatypes .....	3-11
DATE Datatype .....	3-12
The Default WITH INTERFACE Clause.....	3-12
Procedures.....	3-12
Functions .....	3-12
<b>Storing Module Language Procedures</b> .....	3-14
<b>Connecting to a Database</b> .....	3-15

### 4 Developing the Ada Application

<b>Program Structure</b> .....	4-1
<b>Error Handling</b> .....	4-2
SQLCODE .....	4-2

Obtaining Error Message Text .....	4-2
SQLSTATE .....	4-3
<b>Obtaining the Number of Rows Processed .....</b>	<b>4-4</b>
<b>Handling Nulls .....</b>	<b>4-4</b>
Indicator Variables .....	4-5
<b>Cursors .....</b>	<b>4-6</b>
<b>Specification Files .....</b>	<b>4-6</b>
<b>Calling a Procedure .....</b>	<b>4-6</b>
<b>Arrays as Procedure Arguments .....</b>	<b>4-7</b>
<b>National Language Support .....</b>	<b>4-7</b>

## 5 Running SQL\*Module

<b>SQL*Module Input and Output .....</b>	<b>5-1</b>
Input sources.....	5-1
Output Files.....	5-2
Determining the Input Source .....	5-2
<b>Invoking SQL*Module.....</b>	<b>5-3</b>
Running the Compiler.....	5-3
<b>Case Sensitivity in Program Names, Option Names, and Values.....</b>	<b>5-4</b>
Listing Options and Default Values .....	5-4
<b>How to Specify Command-Line Options .....</b>	<b>5-4</b>
Value Lists .....	5-5
Default Values .....	5-5
<b>Configuration Files.....</b>	<b>5-6</b>
<b>Input Files .....</b>	<b>5-6</b>
<b>Output Files .....</b>	<b>5-6</b>
Source Code Output File.....	5-7
Default File Names for Ada.....	5-7
Specification File.....	5-7
Default Specification Filenames for Ada .....	5-7
Listing File.....	5-7
PL/SQL Source Files.....	5-8
Avoid Default Output Filenames .....	5-8
<b>Command-Line Options .....</b>	<b>5-8</b>
AUTO_CONNECT.....	5-10
BINDING.....	5-10
CONFIG.....	5-11
ERRORS.....	5-11
FIPS.....	5-11
INAME.....	5-12
LNAME.....	5-12
LTYPE .....	5-12
MAPPING .....	5-13
MAXLITERAL .....	5-13
ONAME.....	5-13
OUTPUT .....	5-14
PNAME.....	5-14

RPC_GENERATE .....	5-15
SELECT_ERROR .....	5-15
SNAME .....	5-15
STORE_PACKAGE .....	5-16
SQLCHECK .....	5-16
USERID .....	5-17
<b>Compiling and Linking</b> .....	5-17
An Example (Module Language).....	5-17

## 6 Demonstration Programs

<b>The SQL_STANDARD Package</b> .....	6-1
SQLCODE .....	6-1
SQLSTATE .....	6-1
<b>Sample Programs</b> .....	6-1
Sample Tables .....	6-2
MKTABLES.SQL .....	6-2
DEPARTMT.SQL .....	6-3
INSTRUCS.SQL.....	6-4
STUDENTS.SQL.....	6-4
COURSES.SQL .....	6-5
EMROLMNT.SQL.....	6-5
Module Language Sample Program.....	6-7
Calling a Stored Procedure .....	6-12
<b>Sample Applications</b> .....	6-15
DEMOHOST.A .....	6-15
DEMCALSP.A .....	6-28

## A New Features

<b>New Statements</b> .....	A-1
<b>Other New Features</b> .....	A-1

## B Module Language Syntax

<b>Module Language Syntax Diagrams</b> .....	B-1
Preamble .....	B-2
LANGUAGE Clause .....	B-2
AUTHORIZATION Clause .....	B-2
Cursors.....	B-2
Procedure Definitions.....	B-2
<b>WITH INTERFACE CLAUSE</b> .....	B-3

## C Reserved Words

<b>Module Reserved Words</b> .....	C-1
------------------------------------	-----

## D SQLSTATE Codes

<b>SQLSTATE Codes</b> .....	D-1
-----------------------------	-----

## **E System-Specific References**

<b>System-Specific Aspects of SQL*Module .....</b>	<b>E-1</b>
Supported Compilers .....	E-1
Character Case in Command Lines .....	E-1
Location of Files.....	E-1
Filename Extensions .....	E-1
Ada Output Files .....	E-1
Command Line .....	E-1
Ada SQL_STANDARD Package .....	E-2

## **Index**





---

---

# Send Us Your Comments

## **Oracle SQL\*Module for Ada Programmer's Guide, Release 8.0**

**Part No. A58231-03**

Oracle welcomes your comments and suggestions on the quality and usefulness of this publication. Your input is an important part of the information used for revision.

- Did you find any errors?
- Is the information clearly presented?
- Do you need more information? If so, where?
- Are the examples correct? Do you need more examples?
- What features did you like most about this manual?

If you find any errors or have any other suggestions for improvement, please indicate the title and part number of the documentation and the chapter, section, and page number (if available). You can send comments to us in the following ways:

- Electronic mail: [infodev\\_us@oracle.com](mailto:infodev_us@oracle.com)
- FAX: (650) 506-7227. Attn: Server Technologies Documentation Manager
- Postal service:

Oracle Corporation  
Server Technologies Documentation Manager  
500 Oracle Parkway, Mailstop 4op11  
Redwood Shores, CA 94065  
USA

If you would like a reply, please give your name, address, telephone number, and electronic mail address (optional).

If you have problems with the software, please contact your local Oracle Support Services.



---

---

# Preface

This book is a comprehensive user's guide and reference for SQL\*Module, an Oracle application development tool.

This Guide includes a complete description of *Module Language*, an ANSI/ISO SQL standard for developing applications that access data stored in a relational database. Module Language uses parameterized procedures to encapsulate SQL statements. The procedures can then be called from an Ada application.

This Guide also describes how you can use SQL\*Module to call PL/SQL procedures stored in an Oracle database. A number of complete examples using Module Language, Ada code, and stored database procedures are provided.

This Preface contains these topics:

- [Intended Audience](#)
- [Documentation Accessibility](#)
- [Structure](#)
- [Related Documents](#)
- [Conventions](#)

## Intended Audience

Oracle SQL\*Module for Ada Programmer's Guide is intended for systems architects, analysts, and developers who are writing large-scale applications that access an Oracle Server. Chapter 1 of this Guide can also be used by managers who need to determine if SQL\*Module is an appropriate tool for a planned project.

To use this Guide effectively, you need a working knowledge of the following topics:

- applications programming in Ada
- the SQL database language
- Oracle database concepts and terminology

Familiarity with SQL-standard Module Language is not a prerequisite. This Guide fully documents Module Language.

## Documentation Accessibility

Our goal is to make Oracle products, services, and supporting documentation accessible, with good usability, to the disabled community. To that end, our documentation includes features that make information available to users of assistive

technology. This documentation is available in HTML format, and contains markup to facilitate access by the disabled community. Standards will continue to evolve over time, and Oracle is actively engaged with other market-leading technology vendors to address technical obstacles so that our documentation can be accessible to all of our customers. For additional information, visit the Oracle Accessibility Program Web site at

<http://www.oracle.com/accessibility/>

**Accessibility of Code Examples in Documentation** JAWS, a Windows screen reader, may not always correctly read the code examples in this document. The conventions for writing code require that closing braces should appear on an otherwise empty line; however, JAWS may not always read a line of text that consists solely of a bracket or brace.

**Accessibility of Links to External Web Sites in Documentation** This documentation may contain links to Web sites of other companies or organizations that Oracle does not own or control. Oracle neither evaluates nor makes any representations regarding the accessibility of these Web sites.

## Standards Conformance

SQL\*Module conforms to the American National Standards Institute (ANSI) and International Standards Organization (ISO) standards for Module Language. This includes complete conformance with Chapter 7 of ANSI document X3.135-1989, *Database Language SQL with Integrity Enhancement*.

In addition, SQL\*Module conforms to the "Entry SQL" subset of the SQL92 standard, as defined in Chapter 12 of the ANSI Document X3.135-1992.

Note: SQL92 is known officially as International Standard ISO/IEC 9075:1992, Database Language SQL.

SQL\*Module supports the Ada83 language standard for Ada.

Oracle has also implemented extensions to the SQL language and to Module Language. This Guide describes both the SQL standard Module Language and the complete set of Oracle extensions. SQL\*Module provides an option, called the *FIPS flagger*, which flags all non-standard extensions to SQL and to Module Language, as mandated by the *Federal Information Processing Standard for Database Language SQL*, FIPS publication 127-1. This publication is available from

National Technical Information Service  
US Department of Commerce  
Springfield VA 22161  
U.S.A

## Structure

This document contains:

### **Chapter 1, "Introduction to SQL\*Module"**

This chapter introduces you to Oracle's Module Language compiler. You learn what SQL\*Module is, when it is appropriate to use SQL\*Module for a project, and what features the SQL\*Module compiler offers. The chapter also provides an overview showing how to develop an application using SQL\*Module.

### **Chapter 2, "Module Language"**

This chapter documents SQL standard Module Language, and also describes the Oracle extensions to the Module Language standard.

### **Chapter 3, "Accessing Stored Procedures"**

This chapter describes how to use SQL\*Module to generate code output files that contain interface procedures (stubs) used to call PL/SQL procedures stored in an Oracle database.

### **Chapter 4, "Developing the Ada Application"**

This chapter describes the steps you take to develop an application using SQL\*Module. This chapter also includes a sample application in Module Language. The Module Language code and the SQL scripts that build the sample database are listed; they are also available on-line, in the *demo* directory.

### **Chapter 5, "Running SQL\*Module"**

This chapter tells you how to invoke SQL\*Module, what input and output files are required and are generated, and describes all the command-line options.

### **Chapter 6, "Demonstration Programs"**

This chapter describes Ada-specific aspects of using SQL\*Module, including parameter passing conventions and binding of Ada datatypes to SQL datatypes. This chapter also contains several sample programs that call stored procedures and Module Language procedures.

### **Appendix A, "New Features"**

This appendix provides lists of new statements and other new features in release 8.0.

### **Appendix B, "Module Language Syntax"**

This appendix presents the formal syntax of Module Language using syntax diagrams.

### **Appendix C, "Reserved Words"**

This appendix lists the keywords and reserved words that you cannot use for names of modules, cursors, procedures, and procedure parameters in a Module Language application.

### **Appendix D, "SQLSTATE Codes"**

This appendix contains a table of the SQLSTATE codes.

### **Appendix E, "System-Specific References"**

This appendix contains a list of all system-dependent aspects of SQL\*Module for Ada that are mentioned elsewhere in this guide.

## **Related Documents**

Printed documentation is available for sale in the Oracle Store at

<http://oraclestore.oracle.com/>

To download free release notes, installation documentation, white papers, or other collateral, please visit the Oracle Technology Network (OTN). You must register online before using OTN; registration is free and can be done at

<http://otn.oracle.com/membership/>

If you already have a username and password for OTN, then you can go directly to the documentation section of the OTN Web site at

<http://otn.oracle.com/documentation/>

## Conventions

This section describes the conventions used in the text and code examples of this documentation set. It describes:

- [Conventions in Text](#)
- [Conventions in Code Examples](#)

### Conventions in Text

The style of the Ada Language Reference Manual is generally followed: reserved words are lowercase, identifiers are uppercase. In running text, reserved words are bold and identifiers are uppercase. Filenames are lowercase.

Additionally, we use various conventions in text to help you more quickly identify special terms. The following table describes those conventions and provides examples of their use.

Convention	Meaning	Example
<b>Bold</b>	Bold typeface indicates terms that are defined in the text or terms that appear in a glossary, or both.	When you specify this clause, you create an <b>index-organized table</b> .
<i>Italics</i>	Italic typeface indicates book titles or emphasis.	<i>Oracle Database Concepts</i> Ensure that the recovery catalog and target database do <i>not</i> reside on the same disk.
UPPERCASE monospace (fixed-width) font	Uppercase monospace typeface indicates elements supplied by the system. Such elements include parameters, privileges, datatypes, RMAN keywords, SQL keywords, SQL*Plus or utility commands, packages and methods, as well as system-supplied column names, database objects and structures, usernames, and roles.	You can specify this clause only for a NUMBER column. You can back up the database by using the BACKUP command. Query the TABLE_NAME column in the USER_TABLES data dictionary view. Use the DBMS_STATS.GENERATE_STATS procedure.
lowercase monospace (fixed-width) font	Lowercase monospace typeface indicates executables, filenames, directory names, and sample user-supplied elements. Such elements include computer and database names, net service names, and connect identifiers, as well as user-supplied database objects and structures, column names, packages and classes, usernames and roles, program units, and parameter values.  <b>Note:</b> Some programmatic elements use a mixture of UPPERCASE and lowercase. Enter these elements as shown.	Enter <code>sqlplus</code> to start SQL*Plus. The password is specified in the <code>orapwd</code> file. Back up the datafiles and control files in the <code>/disk1/oracle/dbs</code> directory. The <code>department_id</code> , <code>department_name</code> , and <code>location_id</code> columns are in the <code>hr.departments</code> table. Set the <code>QUERY_REWRITE_ENABLED</code> initialization parameter to <code>true</code> . Connect as <code>oe</code> user. The <code>JRepUtil</code> class implements these methods.

Convention	Meaning	Example
<i>lowercase italic monospace (fixed-width) font</i>	Lowercase italic monospace font represents placeholders or variables.	You can specify the <i>parallel_clause</i> .  Run <i>old_release</i> .SQL where <i>old_release</i> refers to the release you installed prior to upgrading.

### Conventions in Code Examples

Code examples illustrate SQL, PL/SQL, SQL\*Plus, or other command-line statements. They are displayed in a monospace (fixed-width) font and separated from normal text as shown in this example:

```
SELECT username FROM dba_users WHERE username = 'MIGRATE';
```

The following table describes typographic conventions used in code examples and provides examples of their use.

Convention	Meaning	Example
[ ]	Brackets enclose one or more optional items. Do not enter the brackets.	DECIMAL ( <i>digits</i> [ , <i>precision</i> ])
{ }	Braces enclose two or more items, one of which is required. Do not enter the braces.	{ENABLE   DISABLE}
	A vertical bar represents a choice of two or more options within brackets or braces. Enter one of the options. Do not enter the vertical bar.	{ENABLE   DISABLE} [COMPRESS   NOCOMPRESS]
...	Horizontal ellipsis points indicate either: <ul style="list-style-type: none"> <li>That we have omitted parts of the code that are not directly related to the example</li> <li>That you can repeat a portion of the code</li> </ul>	CREATE TABLE ... AS <i>subquery</i> ;  SELECT <i>col1</i> , <i>col2</i> , ... , <i>coln</i> FROM employees;
.	Vertical ellipsis points indicate that we have omitted several lines of code not directly related to the example.	SQL> SELECT NAME FROM V\$DATAFILE; NAME ----- /fs1/dbs/tbs_01.dbf /fs1/dbs/tbs_02.dbf . . . /fs1/dbs/tbs_09.dbf 9 rows selected.
Other notation	You must enter symbols other than brackets, braces, vertical bars, and ellipsis points as shown.	acctbal NUMBER(11,2); acct CONSTANT NUMBER(4) := 3;
<i>Italics</i>	Italicized text indicates placeholders or variables for which you must supply particular values.	CONNECT SYSTEM/ <i>system_password</i> DB_NAME = <i>database_name</i>

Convention	Meaning	Example
UPPERCASE	Uppercase typeface indicates elements supplied by the system. We show these terms in uppercase in order to distinguish them from terms you define. Unless terms appear in brackets, enter them in the order and with the spelling shown. However, because these terms are not case sensitive, you can enter them in lowercase.	<pre>SELECT last_name, employee_id FROM employees; SELECT * FROM USER_TABLES; DROP TABLE hr.employees;</pre>
lowercase	<p>Lowercase typeface indicates programmatic elements that you supply. For example, lowercase indicates names of tables, columns, or files.</p> <p><b>Note:</b> Some programmatic elements use a mixture of UPPERCASE and lowercase. Enter these elements as shown.</p>	<pre>SELECT last_name, employee_id FROM employees; sqlplus hr/hr CREATE USER mjones IDENTIFIED BY ty3MU9;</pre>



---

# Introduction to SQL\*Module

Chapter 1 introduces you to SQL\*Module. This chapter answers the following questions:

- [What Is SQL\\*Module?](#)
- [SQL\\*Module as an Interface Builder](#)
- [What Is Supported by SQL\\*Module?](#)
- [What SQL Statements are Not Supported by SQL\\*Module?](#)

## What Is SQL\*Module?

You use SQL\*Module to develop and manage Ada applications that access data in an Oracle database. It allows an Ada application to access relational databases without using embedded SQL, and without using a proprietary application programming interface.

SQL\*Module fulfills three roles in application development:

- It compiles SQL standard Module Language files. A Module Language file contains parameterized procedures that encapsulate SQL statements. These procedures are translated by the SQL\*Module compiler into calls to a SQL runtime library that interacts with the Oracle server.
- It builds Ada code files that contain interface procedures (often called *stubs*). This allows your application to call stored procedures in an Oracle database directly, without requiring an anonymous PL/SQL block. The interface procedures can be time-stamped, so if the stored procedure is recompiled after the interface procedure was generated, a runtime error occurs.
- SQL\*Module can also *generate* stored procedures in a database, by compiling Module Language files, and storing the procedures as part of stored packages, with the appropriate interface mechanism automatically provided in the package's procedure declarations.

## Background

The SQL language was designed to operate on entities in a relational database. SQL was not designed to be a general-purpose programming language, and, in fact, it is conceptually very different from 3GLs such as Ada or C. Some of these differences are:

- SQL is a non-procedural database manipulation language, hence it deals with database objects, such as tables, rows, columns, and cursors. A third-generation language deals with data structures such as scalar variables, arrays, records, and lists.

- SQL has a limited ability to express complicated computational operations.
- SQL does not provide the procedural capabilities (such as flow of control statements) that are required to implement efficient programs.

To achieve maximum flexibility when creating large applications, you must combine SQL with host procedural programming language statements. There are several ways to do this, and these are discussed briefly in the next section.

## Precompilers

One way to use a procedural language to access data in a relational database is to embed SQL statements directly in a program written in a host 3GL such as C or C++. After the program is coded, you use a precompiler to translate the SQL statements into calls to a runtime library that processes the SQL, and submits the SQL statements to the database.

See [Figure 1-1, "Developing with the Precompilers"](#) for details of this process.

While embedded SQL is very useful, it can have drawbacks when very large applications are being developed. There are several reasons for this:

- Use of embedded SQL requires study of the technical details of the precompiler.
- SQL code does not follow the syntactic and semantic constraints of the host language, and can confuse specialized tools, such as syntax-directed editors and "lint" programs.
- When the precompiler processes code that contains embedded SQL, it introduces extra data structures and code in the generated output code, making source-level debugging more difficult.
- Techniques for error handling and recovery in embedded SQL programs can be difficult to understand and apply, and subtle bugs can arise when developers do not appreciate all the problems involved in embedded SQL error handling.

[Figure 1-1](#) shows how you develop applications using the Oracle precompilers.

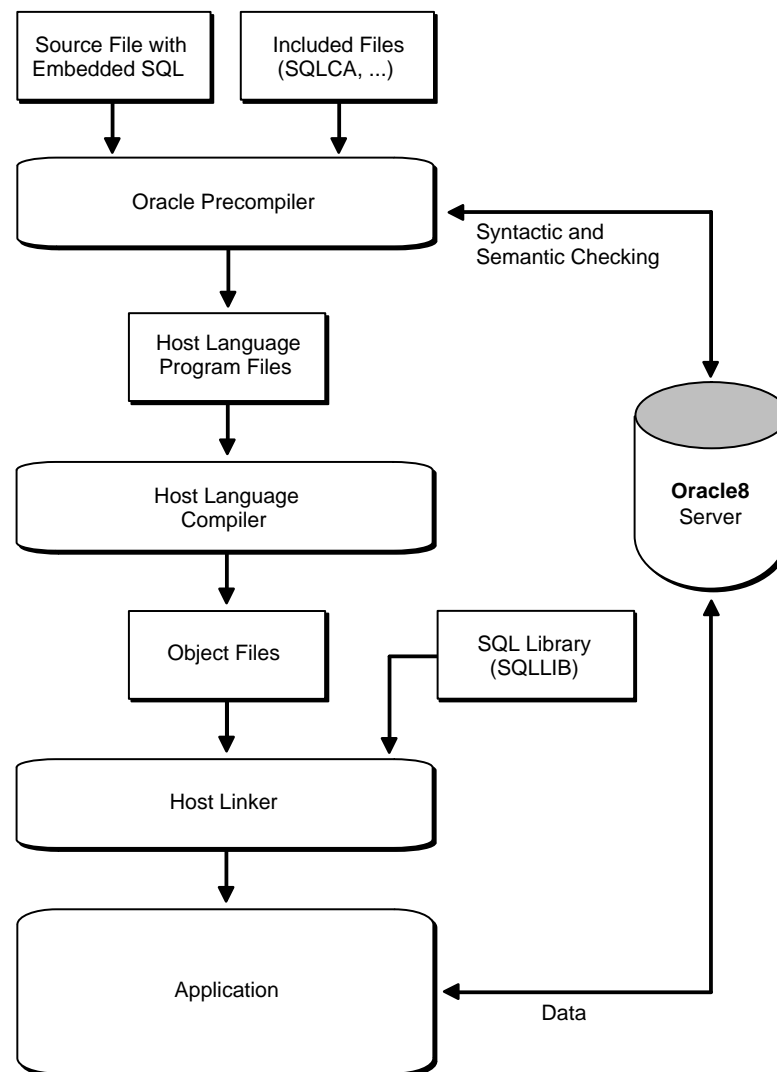
**Figure 1-1** *Developing with the Precompilers*

## The Module Language Concept

The ANSI SQL standards committee defined the embedded SQL standard in two steps. A formalism called Module Language was defined, then the embedded SQL standard was derived from Module Language.

Using Module Language is very straightforward: place all SQL code in a separate module, and define an interface between the module containing the SQL code and the host program written in Ada. At the most concrete level, the interface simply consists of

- a standard way of calling Module Language procedures from Ada.
- a standard way to return error and warning information
- specification of conversions between SQL datatypes (such as DOUBLE PRECISION or SMALLINT) and host language datatypes or derived types defined in a standard package in Ada

It is also possible to develop more abstract interfaces between the host language and Module Language. One example of this is the SAMeDL (SQL Ada Module Description Language) developed at Carnegie Mellon and the Software Engineering Institute.

Figure 1-2 shows how you would develop an application using SQL standard Module Language.

Figure 1-2 Developing with Module Language

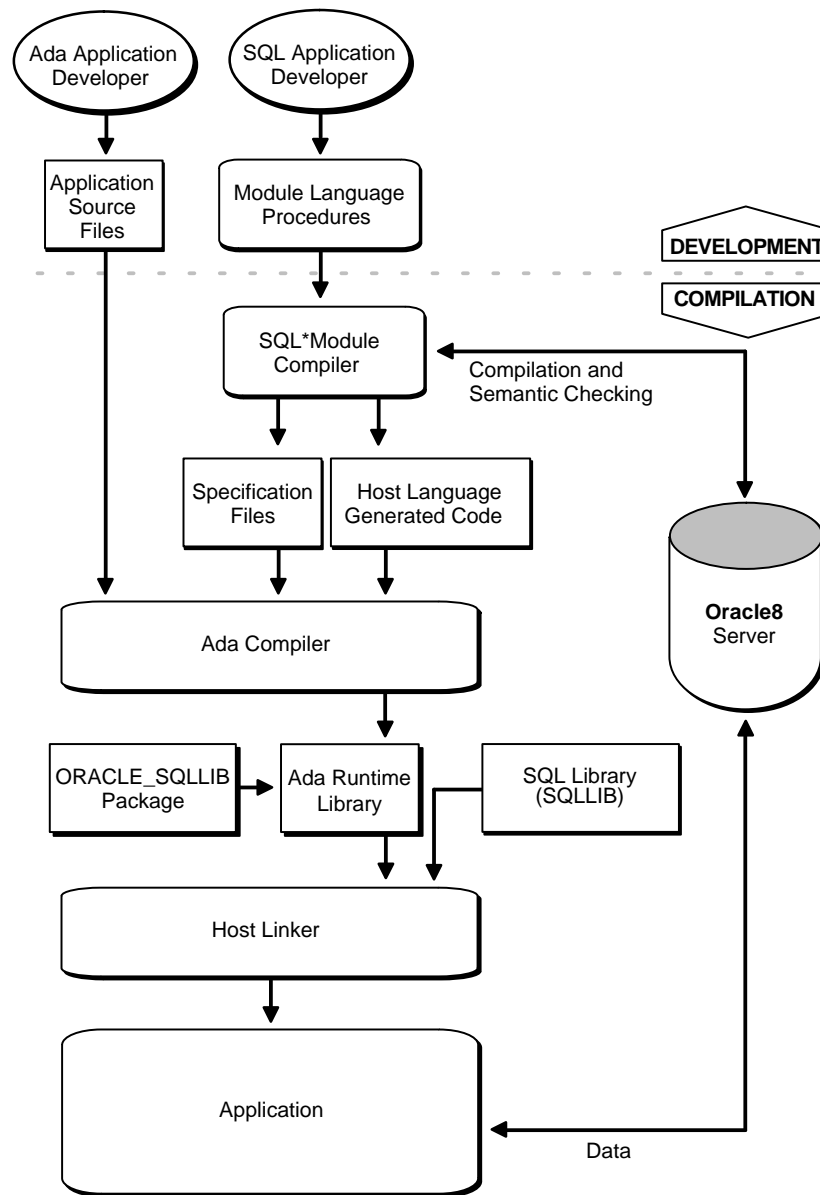

A Module Language compiler such as SQL\*Module generates a call-level interface to procedures defined within a module, allowing them to be called like any other host language procedure. Details of the implementation of these procedures are hidden from the application.

The most immediate benefit of this approach is specialization. By separating SQL and the host language, an application developer can focus on using the host language to

perform application tasks, and a database developer can focus on using SQL to perform database tasks.

The developer of the application does not need to know SQL. The procedures to be called can be treated as canned routines that return variables of well defined datatypes in the host language. Error handling becomes straightforward, since all module procedures can return a single error indicator.

Figure 1–3 shows the operation of SQL\*Module when it is used to compile SQL standard modules. The module file contains a preamble, defining the host 3GL to be Ada, and two simple procedures in Module Language. When SQL\*Module compiles this module, it produces two output files: a *source code output file*, that contains calls to the runtime library SQLLIB that do the work of accessing the database, and a *specification file* that declares the procedures in the source code file.

You include the specification files in the host application code that calls the module procedures, using the appropriate language-specific mechanism.

**Figure 1–3 Compiling a Module**

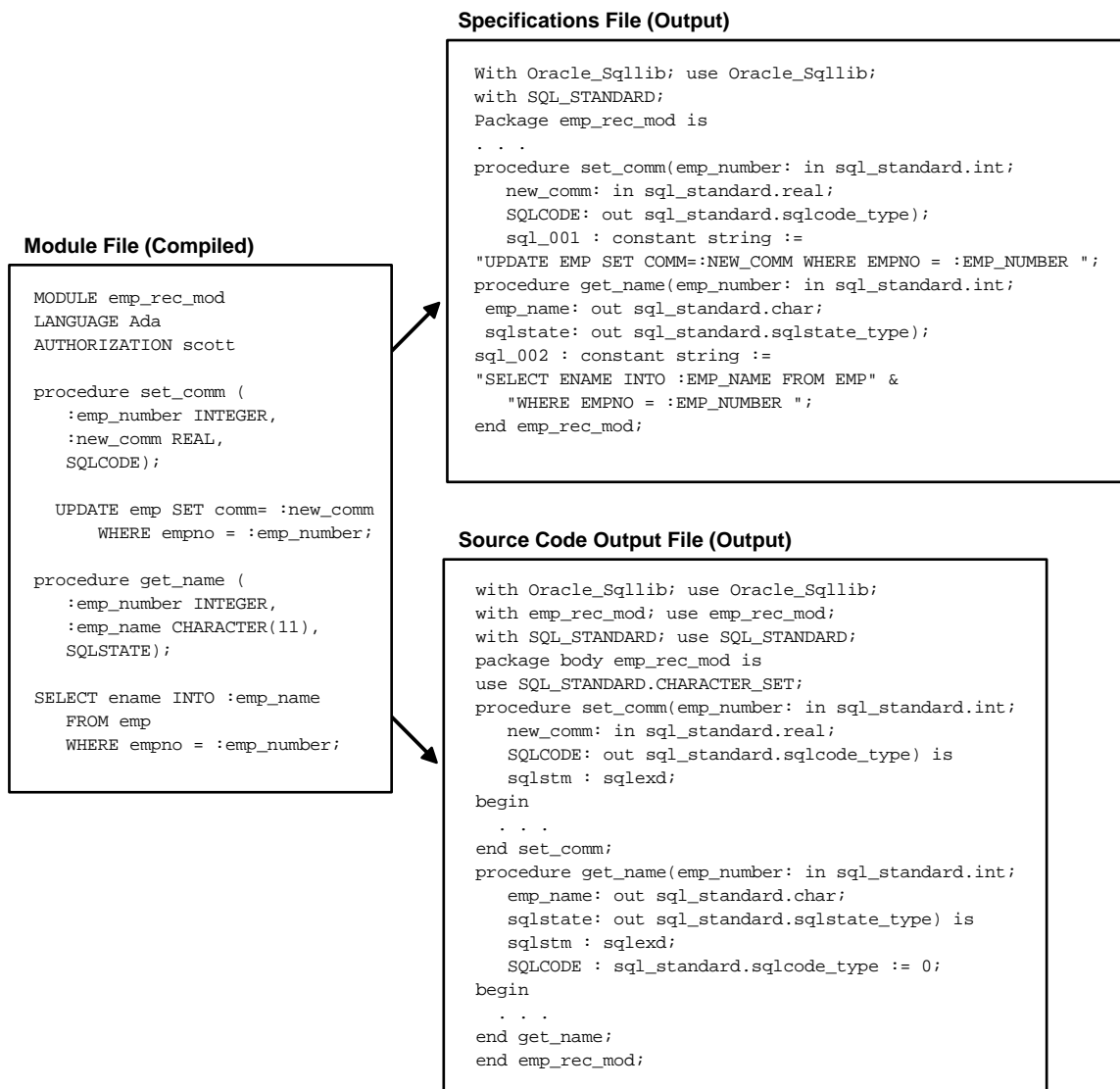

## SQL\*Module as an Interface Builder

In addition to its role as a Module Language compiler, SQL\*Module can also build host language interfaces to procedures that are stored in an Oracle database.

[Figure 1-4](#) shows schematically how SQL\*Module functions as an interface builder. The compiler extracts the interfaces to stored procedures, and creates an Ada output file that contains calls to the procedures. YourAda application then accesses the stored procedures in the database by calling these interface procedures.

When you create interface procedure files (output files that contain interface procedures for calling stored procedures), you can choose either *early binding* or *late binding*.

The early binding option creates a time stamp in the interface procedure for the time that the stored procedure was last compiled. If the stored procedure has been recompiled after the interface procedure was generated, a runtime error is generated when the interface procedure is called from the host application.

The late binding option calls the stored procedure through an anonymous PL/SQL block, and no time stamp is used. See "[Early and Late Binding](#)" on page 3-5 for more information about binding.

Figure 1-4 SQL\*Module as an Interface Builder

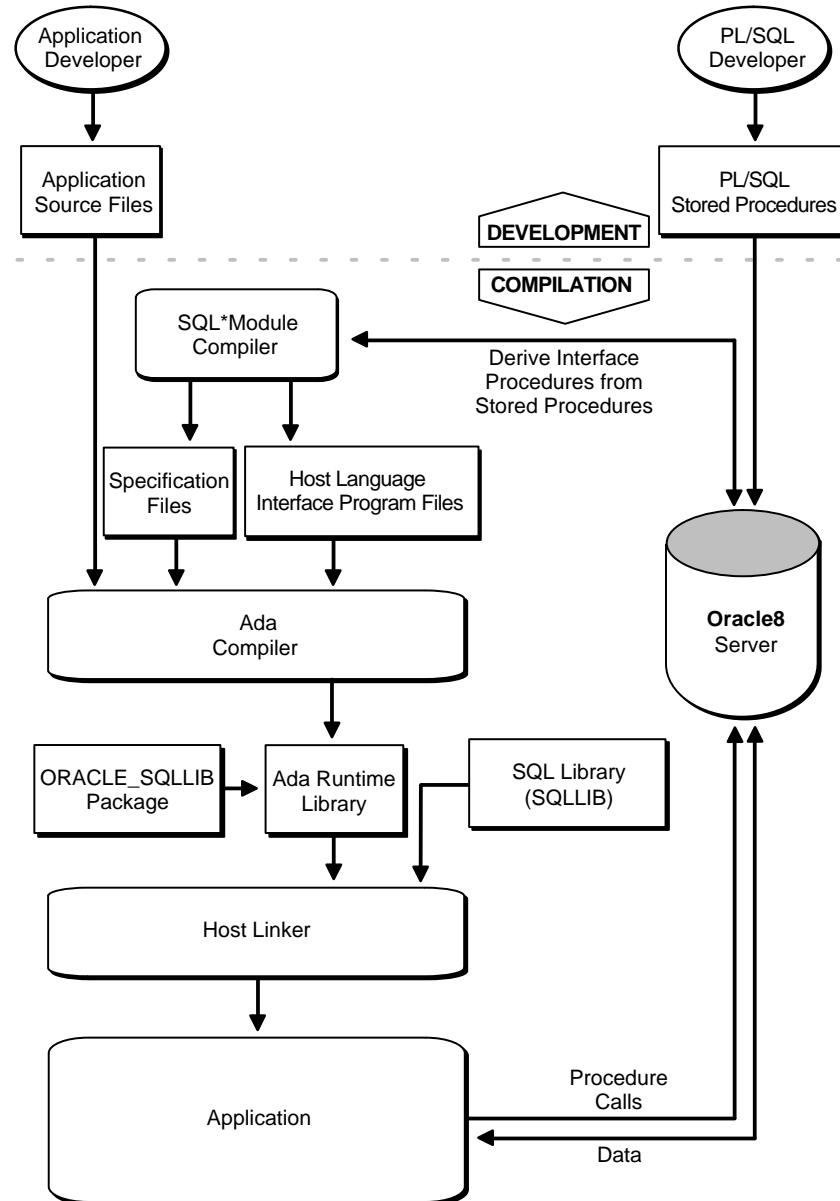

## What Is Supported by SQL\*Module?

SQL\*Module supports international standards for Module Language. Refer to the Preface to this Guide for more information about supported standards. In addition, Oracle has extended the current standard in several ways. For example, datatype conversions between Oracle datatypes and Ada datatypes are defined, comments can be used in a module, and so forth. [Chapter 2, "Module Language"](#) describes the Module Language capabilities of SQL\*Module in detail. A compile time option, the *FIPS flagger*, is available to flag use of non-standard extensions to Module Language and to SQL.

In addition to the complete Module Language standard, SQL\*Module also provides a way for a host application to access PL/SQL stored procedures in an Oracle database.

If a package exists in an Oracle database that contains procedures, you can use SQL\*Module to build interface procedures corresponding to the PL/SQL procedures in the package. Thus the application can call the stored procedures directly.

SQL\*Module generates code and specification files that can be compiled with the Ada compiler.

You can compile your stored procedures or modules to get an interface procedures file and call the modules directly from an Ada host program.

## What SQL Statements are Not Supported by SQL\*Module?

- DDL (Data Definition Language) is not supported.
- DML (Data Manipulation Language) statements other than SELECT, UPDATE, DELETE, and INSERT, are not supported.
- Transaction control statements other than COMMIT and ROLLBACK, and CONNECT and DISCONNECT are not supported.



---

## Module Language

This chapter describes SQL standard Module Language, including Oracle's extensions to standard Module Language. It discusses the following topics:

- [The Module](#)
- [Structure of a Module](#)
- [SQL Datatypes](#)
- [SQL Commands](#)
- [Text in a Module](#)
- [Indicator Parameters](#)
- [Status Parameters](#)
- [CONNECT Statement](#)
- [DISCONNECT Statement](#)
- [Multi-tasking](#)
- [Multi-tasking Example](#)

This chapter does *not* cover the use of SQL\*Module to provide interfaces to stored procedures. See [Chapter 3, "Accessing Stored Procedures"](#) for information about calling stored procedures from a host application.

### The Module

A *module* is a single file that contains

- introductory material, in a *preamble*
- optional *cursor declarations* for use by queries that can return multiple rows of data
- definitions of *procedures* to be called by the host application

The easiest way to see how a module is constructed is to look at an example. The small module below contains a cursor declaration, procedures that open and close the cursor, and a procedure that uses the cursor to fetch data from the familiar EMP table. Two consecutive dashes (- -) begin a comment, which continues to the end of the line. Case is not significant.

### An Example Module

```
-- the preamble (contains three clauses)
--
MODULE      EXAMPLE1_MOD      -- Define a module named example1_mod.
```

```
LANGUAGE   Ada           -- The procedures are compiled into
                        -- Ada, and called from an
                        -- Ada application.

AUTHORIZATION SCOTT/TIGER -- Use Scott's tables.
                        -- His password is "tiger"
                        -- (the password does not have to
                        -- be specified in the module file).

-- Declare a cursor for a SELECT statement that
-- fetches four columns from the EMP table.
-- dept_number will be specified
-- in the procedure that opens the cursor.

DECLARE cursor1 CURSOR FOR
    SELECT ename, empno, sal, comm
    FROM emp
    WHERE deptno = :dept_number

-- Define a procedure named "open_cursor1" to open the cursor.
-- After the procedure name is a comma-separated parameter list
-- enclosed in ()'s.
PROCEDURE open_cursor1 (
    :dept_number    INTEGER,
    SQLCODE);

    OPEN cursor1;

-- The "fetch_emp_data" procedure gets data from the cursor.
-- SQLCODE will return as 100 when there
-- is no more data.
PROCEDURE fetch_emp_data (
    :empno          INTEGER,
    :empname        VARCHAR2(10),
    :sal            REAL,
    :commission     REAL,
    :comm_ind       SMALLINT,
    SQLCODE);

-- the SQL command is a FETCH on the cursor
    FETCH cursor1
    INTO :empname,
        :empno,
        :sal,
        :commission INDICATOR :comm_ind;

-- Define a procedure to close the cursor.
PROCEDURE close_cursor1 (SQLCODE);
    CLOSE cursor1;

-- Connect to a database
PROCEDURE do_connect (
    :dbname         VARCHAR2(12),
    :username       VARCHAR2(12),
    :passwd         VARCHAR2(12),
    SQLCODE);
```

```

CONNECT TO :dbname USER :username USING :passwd;

-- Disconnect
PROCEDURE do_disconnect (SQLCODE);

DISCONNECT CURRENT;

```

Note: If you are familiar with the syntax of SQL89 Module Language, you should note that the newer SQL92 syntax is used in this example. This includes parentheses around a comma-separated parameter list, colons before parameters, and use of the INDICATOR keyword. This syntax is supported by the current release of SQL\*Module, and is used throughout this Guide.

In this example, the LANGUAGE clause (in the second line of the module) specifies "Ada". This module will be compiled into Ada code. For SQL\*Module, this clause is optional. When present, it is, in effect, a comment.

When SQL\*Module compiles this module, it transforms the procedures into Ada language procedures that open the cursor and call library routines to fetch the data. SQL\*Module also generates a package specification file, which must be compiled into the Ada library and referenced in the host application using a **with** context clause. See Chapter 5, "Running SQL\*Module" in this Guide for information on running SQL\*Module, and [Chapter 6, "Demonstration Programs"](#) for information about Ada specification files.

## A Short Example Program in Ada

To complete the example, a short Ada program that calls the procedures defined in the module file in "[An Example Module](#)" on page 2-1 follows.

```

-- Include TEXT_IO,SQL_STANDARD and EXAMPLE1_MOD package specs.

with
    SQL_STANDARD,
    TEXT_IO,
    EXAMPLE1_MOD;
use
    SQL_STANDARD;

-- Define the main procedure.

procedure EXAMPLE1_DRV is

-- Instantiate new packages for I/O on SQL_STANDARD datatypes.
    package STD_INT_IO is
        new text_io.integer_io(SQL_STANDARD.INT);
    use STD_INT_IO;

    package SQLCODE_IO is
        new text_io.integer_io(SQL_STANDARD.SQLCODE_TYPE);
    use SQLCODE_IO;

    package STD_FLOAT_IO is
        new text_io.float_io(SQL_STANDARD.REAL);
    use STD_FLOAT_IO;

```

```
-- Begin with declarations of all program variables,
-- including parameters for the module procedures.
SERVICE_NAME      : string(1..12)
                   := "INST1_ALIAS ";
USERNAME           : string(1..12)
                   := "SCOTT      ";
PASSWORD           : string(1..12)
                   := "TIGER      ";

DEPT_NUMBER        : SQL_STANDARD.INT;
EMPLOYEE_NUMBER    : SQL_STANDARD.INT;
EMPLOYEE_NAME      : string(1..10);
SALARY             : SQL_STANDARD.REAL;
COMMISSION         : SQL_STANDARD.REAL;
COMM_IND           : SQL_STANDARD.SMALLINT;
SQLCODE            : SQL_STANDARD.SQLCODE_TYPE;
LENGTH             : integer;

CONNECT_ERROR      : exception;
SQLCODE_ERROR      : exception;

begin

-- Call a module procedure to connect
-- to the Oracle server.
EXAMPLE1_MOD.DO_CONNECT
    (SERVICE_NAME, USERNAME, PASSWORD, SQLCODE);

-- Test SQLCODE to see if the connect succeeded.
if SQLCODE /= 0 then
    raise CONNECT_ERROR;
end if;

TEXT_IO.NEW_LINE(2);

-- Get an input value from user to use
-- in opening the cursor.
TEXT_IO.PUT("Enter department number: ");
STD_INT_IO.GET(DEPT_NUMBER);
TEXT_IO.NEW_LINE;

-- Call the module procedure to open the cursor.
-- You open the cursor using the input parameter (dept_number).
EXAMPLE1_MOD.OPEN_CURSOR1(DEPT_NUMBER, SQLCODE);
-- If SQLCODE indicates error, call exception handler.
if SQLCODE < 0 then
    raise SQLCODE_ERROR;
end if;

TEXT_IO.PUT_LINE("Employee ID Number Salary Commission");
TEXT_IO.PUT("-----");

-- Call the FETCH procedure in a loop, to get
-- the employee data.
loop
    EXAMPLE1_MOD.FETCH_EMP_DATA
        (EMPLOYEE_NUMBER,
         EMPLOYEE_NAME,
         SALARY,
```

```

        COMMISSION,
        COMM_IND,
        SQLCODE);

    TEXT_IO.NEW_LINE;

-- When SQLCODE = 100, no more rows to fetch.
    exit when SQLCODE = 100;

-- When SQLCODE less than 0, an error occurred.
    if SQLCODE < 0 then
        raise SQLCODE_ERROR;
    end if;

    TEXT_IO.PUT(string(EMPLOYEE_NAME));
    STD_INT_IO.PUT(EMPLOYEE_NUMBER, WIDTH => 9);
    STD_FLOAT_IO.PUT(SALARY, FORE => 6, AFT => 2, EXP => 0);

    if COMM_IND = 0 then
        STD_FLOAT_IO.PUT(COMMISSION, FORE => 9, AFT => 2, EXP => 0);
    else
        TEXT_IO.PUT("        Null");
    end if;
end loop;

TEXT_IO.NEW_LINE(2);

-- Call the procedure to close the cursor.
    EXAMPLE1_MOD.CLOSE_CURSOR1(SQLCODE);

-- Call the procedure to disconnect.
    EXAMPLE1_MOD.DO_DISCONNECT(SQLCODE);

-- Handle the error exception.

exception
    when SQLCODE_ERROR =>
        TEXT_IO.NEW_LINE(2);
        TEXT_IO.PUT("Error fetching data, SQLCODE returns ");
        PUT(SQLCODE);
        TEXT_IO.NEW_LINE(2);

    when CONNECT_ERROR =>
        TEXT_IO.PUT("Connect failure to " &
            string(SERVICE_NAME));
        TEXT_IO.NEW_LINE(2);

end EXAMPLE1_DRV;

```

This example demonstrates several important points about SQL\*Module:

The types of the parameters in the module procedures are SQL datatypes, for example SMALLINT and REAL, not Ada datatypes.

- Parameters are passed to the generated output code procedures in the normal way. Refer to [Chapter 6, "Demonstration Programs"](#) for specific information concerning parameter passing conventions.
- The error status of a call is returned in the SQLCODE or SQLSTATE parameter. There must be a SQLCODE or SQLSTATE status parameter somewhere in the

parameter list of each Module Language procedure. See the section "[Status Parameters](#)" on page 2-13 for more information.

## Structure of a Module

This section is an informal guide to Module Language syntax, including Oracle's extensions to the language. See Appendix B to this Guide for a formal description of Module Language syntax.

A module is contained in a single file and consists of

- a preamble
- zero or more cursor declarations
- one or more procedure definitions

## Preamble

The preamble is a set of clauses at the beginning of a module file that describes the module. The clauses are

- the MODULE clause
- the LANGUAGE clause
- the AUTHORIZATION clause

### MODULE Clause

The MODULE clause gives a name to the module. The argument is the module name, which must be a legal SQL identifier.

Note: A SQL identifier is a string containing only the 26 letters A through Z, the digits 0 through 9, and the underscore ("\_"). The identifier must start with a letter, and cannot be longer than 30 characters (18 characters to comply with the SQL89 standard). You can use lowercase letters (a..z), but a SQL identifier is not case sensitive. So, the identifiers "THIS\_IDENTIFIER" and "this\_identifier" are equivalent. The characters '\$' and '#' are also allowed in a SQL identifier, but you should avoid using them, as they have special meaning in many languages and operating systems.

The module name must be supplied. The module name must be the same as the name of the Ada library unit that you use when you store the Ada-compiled output in your Ada library.

### LANGUAGE Clause

The LANGUAGE clause specifies the target language. It takes one argument — the language name, which must be Ada (case is not significant).

The LANGUAGE clause is optional in SQL\*Module. See [Chapter 5, "Running SQL\\*Module"](#) for more information about running SQL\*Module.

### AUTHORIZATION Clause

The AUTHORIZATION clause is required. This clause can determine, or help to determine, the database and schema that SQL\*Module uses at compile time.

The argument to the AUTHORIZATION clause can take one of four forms:

- the username: scott
- scott

- the username plus a password, the two separated by a slash: `scott/tiger`

- `scott/tiger`

- the username plus a database to connect to:

```
scott@{instance_alias | net8_connection_string}
}
```

- a full specification, consisting of the username, a password, and the database to connect to: `scott/tiger@{instance_alias | net8_connection_string}`

- `scott/tiger@{instance_alias | net8_connection_string}`

The `instance_alias` is an alias containing a database name defined in the `tnsnames.ora` file. For more information, talk to your database administrator, or see the manual *Oracle Net Services Administrator's Guide*.

If you do not include the password in the AUTHORIZATION clause, you can specify it when you run `SQL*Module`, using the `USERID` command line option. If you do not specify a `USERID` value that contains a password, `SQL*Module` prompts you for a password. If a database name is not supplied, `SQL*Module` connects using the default database for the specified user.

Note: For security reasons, omit the password in the `SQL*Module` or in any configuration file. You will be prompted for the password at runtime.

An application that calls module procedures is in effect submitting SQL cursor declarations and SQL statements to Oracle for processing at runtime. The application runs with the privileges of the user *executing* the application, not the schema specified either in the AUTHORIZATION clause or at runtime, when the Module Language code was compiled by `SQL*Module`.

So, when the application is executed, the user must be able to connect to the database using the same schema as that specified when the modules were compiled, in order to guarantee access to all database objects referenced in the modules.

## Cursor Declarations

When a query can return multiple rows of data, you must declare a cursor for the statement. There are two different kinds of cursor that you can use in Module Language. You can declare an ANSI-standard cursor in your module file, and write module language procedures to OPEN the cursor, FETCH from it, and CLOSE it. Or, you can use a *cursor variable*. Cursor variables are described in "[Cursor Variables](#)" on page 3-7.

Using a cursor, you retrieve data one row at a time using the SQL FETCH command. Standard cursors are established in Module Language using the DECLARE CURSOR statement.

Note: The cursor name is a SQL identifier; it is not a procedure name. So, the cursor name does not need to be a valid Ada identifier.

The SQL statement in a DECLARE CURSOR clause must not include an INTO clause. The INTO clause is used in the FETCH command in the procedure that references the cursor.

You cannot use parameters when you *declare* a standard cursor. A placeholder is used instead. Placeholders in a cursor declaration must correspond by name to the parameters in the procedure that opens the cursor.

Note the way the variable *dept\_number* is used in the following module fragment, taken from the example used earlier in this chapter:

```
DECLARE cursor1 CURSOR FOR
    SELECT ename, empno, sal, comm
    FROM emp
    WHERE deptno = :dept_number

PROCEDURE open_cursor1 (:dept_number INTEGER, SQLCODE);
    OPEN cursor1;
```

The cursor *declaration* is *NOT* terminated with a semicolon. If it is, SQL\*Module generates a syntax error.

Caution: If the application consists of several modules, a cursor cannot be declared in one module, then referenced in another. Nevertheless, cursor names must be unique across all modules in the application.

## Procedure Definitions

A procedure definition consists of a

- procedure name
- parameter list
- single SQL statement

### Procedure Name

The procedure name is a SQL identifier, and should also be a legal Ada identifier. Procedure names must be unique in the application.

Each procedure in a module must have a distinct name. The procedure name space extends over all modules of an application, so when the application uses more than one module, each procedure must still have a distinct name.

### Parameter List

The parameter list contains one or more formal parameters. Each parameter must have a distinct name, which is a SQL identifier. One of the parameters must be a status parameter: `SQLSTATE` or `SQLCODE`. It can appear anywhere in the parameter list. You can include both. See "[Status Parameters](#)" on page 2-13 for more information about status parameters.

### SQL92 Syntax

In SQL89 Module Language, you defined a procedure using the syntax

```
PROCEDURE proc_name
    <param_1>    <datatype_1>
    <param_2>    <datatype_2>
    SQLCODE;
    <sql_statement>;
```

where `<param_n>` is a formal parameter name and `<datatype_n>` is a SQL datatype. Following the SQL92 standard, SQL\*Module allows the syntax

```
PROCEDURE proc_name (
    :<param_1>    <datatype_1>,
    :<param_2>    <datatype_2>,
    SQLSTATE | SQLCODE );
```



```
<sql_statement>;
```

where the parameter list is surrounded by parentheses, and parameters are separated by commas.

---



---

**Note:** You cannot mix SQL89 and SQL92 syntax. If you separate the elements of the parameter list using commas, you must also place parentheses around the parameter list.

---



---

When SQL\*Module generates the output procedures, the formal parameters appear with the same names, and in the same order, as they appear in the module procedure. You can use the parameter access conventions appropriate for the Ada language when calling the output procedure from the application. Thus Ada programmers can use named parameter association in place of, or in addition to, positional parameter association.

## SQL Datatypes

The following table lists the SQL and Oracle datatypes that you can use in a module parameter list. For more information about arrays, see ["Arrays as Procedure Arguments"](#) on page 4-7.

**Table 2–1 Datatypes**

SQL Datatype	Meaning
CHARACTER	single character
CHARACTER(L)	character string of length L bytes
DOUBLE PRECISION	approximate numeric
INTEGER	exact numeric, no fractional part
REAL	approximate numeric
SMALLINT	exact numeric, no fractional part, equal to or smaller in range than INTEGER
Oracle Datatype	
VARCHAR2(L)	variable-length character string of length L bytes

**Table 2–1 (Cont.) Datatypes**

SQL Datatype	Meaning
SQL*Module Datatypes:	
SQL_CURSOR	cursor variable type
SQL_CONTEXT	task context
ARRAY(N) OF SQL_CURSOR	Arrays of SQL Datatypes shown above. N is the number of elements.
ARRAY(N) OF CHARACTER	
ARRAY(N) OF CHARACTER(L)	
ARRAY(N) OF DOUBLE PRECISION	
ARRAY(N) OF INTEGER	
ARRAY(N) OF REAL	
ARRAY(N) OF SMALLINT	
ARRAY(N) OF VARCHAR2(L)	
Note:	
	CHARACTER can be abbreviated CHAR. INTEGER can be abbreviated INT.

The SQL standard for Module Language allows the use of only a subset of the SQL datatypes for Ada.

Note: All parameters for Module Language procedures must be scalars, arrays, or strings. Records and access types are not supported.

## SQL Commands

Module Language supports the following SQL statement:

- ALLOCATE
- CLOSE
- COMMIT
- CONNECT TO
- CONTEXT ALLOCATE
- CONTEXT FREE
- DELETE
- DISCONNECT
- ENABLE THREADS
- FETCH
- INSERT
- OPEN
- ROLLBACK
- SELECT

- SET CONNECTION
- UPDATE

The DELETE and UPDATE commands may be either searched (the normal mode) or positioned (using the WHERE CURRENT OF <cursor\_name> clause). You can use the OPEN command only for ANSI-standard cursors. You must open cursor variables on the Oracle Server, using PL/SQL code.

## Text in a Module

In general, Module Language is not case sensitive. You can enter keywords and identifiers in any mixture of uppercase and lowercase. Case is significant, however, in character string literals.

Text in a module file is free form. White space (spaces, tabs, and new lines) can be placed anywhere in the file to improve readability. The only exception to this is that identifiers, keywords, and string literals cannot be continued to a new line.

The maximum length of a line in a module is 512 characters.

## Comments

SQL\*Module allows comments in a module file. You can place comments anywhere that white space can appear, except in string literals.

There are two comment styles: SQL-style comments and C-style comments. A SQL-style comment starts with two consecutive dashes, which can appear anywhere on a line, and ends at the end of the line. For example:

```
-- This is a SQL(or Ada)style comment.
-- For multiline comments, you must place the comment
-- dashes on each line.
```

A C-style comment begins with a slash immediately followed by an asterisk (/\*), and ends at the next occurrence of an asterisk immediately followed by a slash (\*). C-style comments can span more than one line. C-style comments cannot be nested.

The following example demonstrates the C-style comment:

```
/*
 * This comment style is often used to
 * introduce a procedure.
 */
```

## Indicator Parameters

You use indicator parameters to set the null/not null status of another (associated) parameter, or to "indicate" if a column value retrieved on a query was null. In the module procedure parameter list, an indicator parameter always has a SMALLINT type. In the SQL statement, the indicator parameter follows the associated parameter, with no comma separation. The SQL92 standard allows the keyword INDICATOR to be used to separate the indicator parameter and its associated parameter.

In the following example, *grade\_indic* is an indicator parameter:

```
PROCEDURE get_grade (
    :grade          REAL,
    :grade_indic    SMALLINT,
    :class_number   INTEGER,
```

```
        :student_id    INTEGER,  
        SQLCODE);  
SELECT grade  
  INTO :grade INDICATOR :grade_indic  
  FROM enrollment  
  WHERE class_no = :class_number AND student_id = :student_id;
```

Following the SQL89 standard, the SELECT statement above would be written without the INDICATOR keyword, as follows:

```
SELECT grade  
  INTO :grade :grade_indic  
  FROM enrollment  
  WHERE class_no = :class_number AND student_id = :student_id;
```

SQL\*Module allows both uses of indicator parameters.

When an indicator parameter is returned from a procedure (an OUT parameter), as in the query example above, its returned value has the following meanings:

-1

The Oracle column or expression is null. The value of the associated parameter (*grade* in this example) is indeterminate.

0

Oracle assigned a column or expression value to the associated parameter.

> 0

For character data, Oracle passed a truncated column value in the associated parameter. The value of the indicator parameter shows the original length of the value in the database column.

When indicator parameters are passed as IN parameters, you must set the value in your Ada program. A value of -1 means that Oracle will assign null to the column (regardless of the value of the associated parameter), and a value of zero or greater means that Oracle will use the value of the associated parameter in the UPDATE or INSERT command. Positive values greater than zero have no special meaning; they are equivalent to zero.

---

---

**Caution:** If you try to assign a null to a database column that has the NOT NULL constraint, an Oracle error is returned at runtime.

---

---

The following code fragment shows an Ada driver that calls a Module Language procedure with a null indicator parameter value:

```
with SQL_STANDARD;  
procedure DRV is  
  SQLCODE    : SQL_STANDARD.SQLCODE_TYPE;  
  EMPLOYEE   : string(1..10) := "SCOTT  ";  
  COMMISSION : SQL_STANDARD.REAL := 2000.0;  
  COMM_IND   : SQL_STANDARD.SMALLINT := -1;  
begin  
  . . .  
  
  UPDATE_COMMISSION(EMPLOYEE, COMMISSION, COMM_IND, SQLCODE);  
  
  . . .  
end;
```

The corresponding Module Language procedure is:

```
PROCEDURE update_commission (
    :employee_name VARCHAR2(10),
    :commission REAL,
    :comm_ind SMALLINT,
    SQLCODE);

UPDATE emp SET comm = :commission INDICATOR :comm_ind
WHERE ename = :employee_name;
```

In this example, the parameter *commission* with a value of 2000.0 is passed to the *update\_commission* procedure. But, since the indicator parameter is set to -1, employee Scott's commission is set to null in the EMP table.

## Status Parameters

There are two special status parameters: SQLSTATE and SQLCODE. The status parameters return values to the calling Ada application that show if

- the procedure completed without error
- an exception occurred, such as "no data found"
- an error occurred

You can place either one or both of the status parameters anywhere in the parameter list. They are always shown last in this Guide, but that is just an informal coding convention. The status parameters are not preceded by a colon, and they do not take a datatype specification. You cannot directly access the status parameters in the SQL statement in the procedure; they are set by SQL\*Module.

SQLSTATE is the preferred status parameter; SQLCODE is retained for compatibility with older standards.

For more information about the status parameters and the values they return, see ["Error Handling"](#) on page 4-2.

## Error Messages

SQL\*Module compile time error messages have the MOD prefix. The codes and messages are listed in *Oracle Database Error Messages*.

## CONNECT Statement

The connect statement associates a program with a database, and sets the *current connection*. The syntax of the command is shown in the following syntax diagram. Key words, which you must spell exactly as shown, are in upper case; tokens you supply are in lower case. If a clause is optional, it is shown off the main path, which flows to from left to right. For a more complete discussion of syntax diagrams, see [Appendix B, "Module Language Syntax"](#).

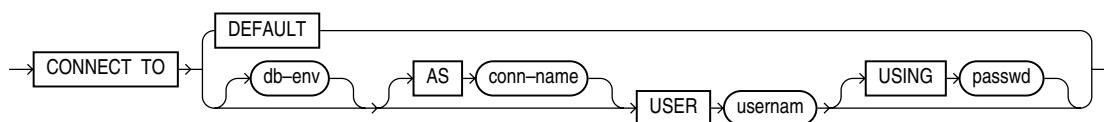

A *db-env* (database environment) is a Net8 connect string or instance-alias. The *conn-name* (connection name) is optional. For multiple connections, you must specify the connection names. You can omit it if you will only use a single connection. The USING clause is optional. A *passwd* is the password..

Connecting as DEFAULT results in a connection to Oracle using either TWO\_TASK (if it applies to your operating system) or ORACLE\_SID and the account specified by the parameter *os\_authent\_prefix* in your file *init.ora*. The optional token *passwd* is the password.

The ANSI SQL92 standard does not allow *db-env* to be optional. This is an Oracle extension (which will be flagged by the FIPS option) which enables a connection to the default server as a specific user.

You must use Net8 in SQL\*Module applications. Note that *passwd* can only be a variable and not a character string literal. All other variables can be either a character string literal or a variable previously defined, preceded by ":".

Here is a illustrative code fragment from a module named *demo.mad*, which contains the following procedure to do a connect:

```
...
PROCEDURE ora_connect (:dbid   VARCHAR2(14),
                      :dbname VARCHAR2(14),
                      :uid     VARCHAR2(14),
                      :pwd     VARCHAR2(14),
                      SQLCODE);
CONNECT TO :dbid AS :dbname USER :uid USING :pwd;
...
```

An Ada application can contain these statements to do the connect:

```
...
pwd : constant string := "tiger";
...
DEMO.ORA_CONNECT("inst1", "RMT1", "scott", PWD, SQLCODE);
if SQLCODE /= 0 then
...

```

For more information, see the *Oracle Net Services Administrator's Guide*.

## SET CONNECTION Statement

The *set connection* statement sets the current connection. Its syntax is:

```
SET CONNECTION { connection-name | DEFAULT }
```

*DEFAULT* is a special case of the connection-name, '/', at the current ORACLE\_SID.

## DISCONNECT Statement

The disconnect command ends an association between an application and a database environment. It can be summarized as:

```
DISCONNECT { connection-name | ALL | CURRENT | DEFAULT }
```

The full ANSI semantics are not followed. Instead of raising an exception condition if the connection has an active transaction, the transaction is (implicitly) rolled back and the connection(s) disconnected.

DISCONNECT ALL only disconnects connections which are established by SQLLIB (that is, by SQL\*Module).

DISCONNECT DEFAULT and DISCONNECT *connection-name* terminate only the specified connection.

DISCONNECT CURRENT terminates the connection regarded by SQLLIB as the "current connection" (either the last connection established or the last connection specified in a SET CONNECTION statement).

After the current connection is disconnected, you must execute a set connection or a connect statement to establish a new current connection. Then you can execute any statement that requires a valid database connection.

You must explicitly commit or roll back the current transaction before disconnecting. If you do not commit the transaction before disconnecting, or if the program exits before committing, the current transaction is automatically rolled back.

Here is an example of two procedures from the module demo.mad illustrating the disconnect command:

```
...
PROCEDURE ora_disconnect (:dbname VARCHAR2(14),
                        SQLCODE) ;
    DISCONNECT :dbname;
...
PROCEDURE ora_commit(SQLCODE);
    COMMIT WORK;
```

these procedures are called from your application as follows:

```
...
DEMO.ORA_COMMIT(SQLCODE);
DEMO.ORA_DISCONNECT("RMT1", SQLCODE);
...
```

A required commit command was executed using the procedure ora\_commit (which is also in the file demo.mad) just before the disconnect. .

## Multi-tasking

Starting with release 8.0, multi-tasking Ada programs are supported by SQL\*Module. The new commands that you use in a multi-tasking program are described in the following sections:

### ENABLE THREADS

This command initializes the process for later use with Ada tasks. It must be called prior to the creation of any Ada tasks. It is:

```
ENABLE THREADS;
```

### SQL\_CONTEXT Datatype

The datatype, *SQL\_CONTEXT*, is used to support multi-tasking applications. It points to SQLLIB's runtime context. You pass the context as a parameter to SQL\*Module procedures. If it is passed, then it indicates which SQLLIB runtime context will be used for execution. If no *SQL\_CONTEXT* parameter is passed, then SQL\*Module uses the global runtime context of SQLLIB.

For example, here is a procedure that uses *SQL\_CONTEXT*:

```
PROCEDURE seldept (:ctx SQL_CONTEXT,
```

```

:dno INTEGER,
SQLCODE);
SELECT deptno INTO :dno FROM emp WHERE dname = 'SALES';

```

In this example, the select statement will use the runtime context pointed to by the variable *ctx*. *ctx* must have been previously allocated in a CONTEXT ALLOCATE statement. Note that you never reference the SQL\_CONTEXT variable directly. It appears only in the code that SQL\*Module generates.

## CONTEXT ALLOCATE

This command allocates storage in memory for a QLLIB runtime context that is used to support multi-tasking. An example is:

```
CONTEXT ALLOCATE :ctxvar;
```

*ctxvar* is of type SQL\_CONTEXT. If sufficient storage is available, *ctxvar* will contain the address of the runtime context. Otherwise, *ctxvar* will be zero and an error will be returned in the provided status variables.

## CONTEXT FREE

CONTEXT FREE frees all storage associated with the QLLIB runtime context. It does not disconnect any active connection. Prior to deallocating the runtime context, you must execute the DISCONNECT command for each active connection.

The CONTEXT FREE statement always succeeds and *ctxvar* is zero after execution. If the context is *ctxvar*, then, an example is:

```
CONTEXT FREE :ctxvar;
```

## Multi-tasking Restrictions

- All database connections must be established prior to task activation.
- Multi-tasking applications cannot be used to access database stored procedures.

## Multi-tasking Example

Here is part of a module, adademo.mad:

```

PROCEDURE enable_threads (SQLCODE);
    ENABLE THREADS;
PROCEDURE allocate_context (:ctx SQL_CONTEXT, SQLCODE);
    CONTEXT ALLOCATE :ctx;
PROCEDURE free_context (:ctx SQL_CONTEXT, SQLCODE);
    CONTEXT FREE :ctx;
PROCEDURE disconn_db (:ctx SQL_CONTEXT,
                    :dbname VARCHAR2(14),
                    SQLCODE);
    DISCONNECT :dbname;

```

these procedures are called as follows:

```

with ADADEMO;
-- Declare contexts CTX1, CTX2
...
ADADEMO.ENABLE_THREADS(SQLCODE);

ADADEMO.ALLOCATE_CONTEXT(CTX1, SQLCODE);
ADADEMO.ALLOCATE_CONTEXT(CTX2, SQLCODE);

```



```
-- Spawn tasks that process data:  
...
```

An example of explicitly disconnecting and freeing contexts is:

```
-- After processing data:  
...  
ADADEMO.DISCONN_DB(CTX1, DBNAM1);  
ADADEMO.DISCONN_DB(CTX2, DBNAM2);  
ADADEMO.FREE_CONTEXT(CTX1);  
ADADEMO.FREE_CONTEXT(CTX2);
```



---

---

## Accessing Stored Procedures

This chapter describes how to use SQL\*Module to generate interface procedures to call stored procedures. It covers the following topics:

- [PL/SQL](#)
- [Stored Procedures](#)
- [Stored Packages](#)
- [Accessing Stored Procedures](#)
- [Case of Package and Procedure Names](#)
- [Early and Late Binding](#)
- [Cursor Variables](#)
- [Dynamic SQL](#)
- [The WITH INTERFACE Clause](#)
- [Storing Module Language Procedures](#)
- [Connecting to a Database](#)

Note: The examples in this chapter use the tables defined in [Chapter 6](#), "Demonstration Programs".

### PL/SQL

This section contains a brief overview of PL/SQL, Oracle's procedural language extension to SQL. PL/SQL is a modern block-structured language that allows you to

- declare constants and variables
- control execution flow, using IF ... THEN ... ELSE, EXIT, GOTO, and other procedural constructs
- create loops, using WHILE ... LOOP and FOR ... LOOP
- assign constant or variable expressions to a variable
- issue SQL Data Manipulation Language and Transaction Control statements
- define exceptions, handle them using WHEN EXCEPTION\_NAME THEN ..., and raise them using RAISE EXCEPTION\_NAME

See the *PL/SQL User's Guide and Reference* for complete information about the PL/SQL language.

## Procedures

A PL/SQL procedure is a named PL/SQL block. Unlike an anonymous block, a procedure can

- take parameters
- be invoked from a separate application
- be compiled once, but invoked many times
- be stored in compiled form in a database, independent of the shared SQL cache

A procedure contains one or more PL/SQL blocks. The following example computes the grade point average. The student ID number is passed as a parameter to the procedure, and the computed grade point average is returned by the procedure.

```
PROCEDURE get_gpa(
    student_id IN NUMBER,
    gpa        OUT NUMBER) IS
    n          NUMBER;
    grade_temp NUMBER;
    gpa_temp   NUMBER; -- needed because PL/SQL cannot read
                       -- an OUT parameter like GPA

    CURSOR c1(sid) IS
        SELECT grade FROM enrollment
           WHERE student_id = sid;

BEGIN
    n := 0;
    gpa := 0;
    OPEN c1(student_id);
    LOOP
        FETCH c1 INTO grade_temp;
        EXIT WHEN c1%NOTFOUND; -- c1%NOTFOUND is TRUE
                               -- when no more data found
        gpa_temp := gpa_temp + grade_temp;
        n := n + 1;
    END LOOP;
    IF n > 0 THEN
        gpa := gpa_temp / n;
    END IF;
    CLOSE c1;
END;
END PROCEDURE get_gpa;
```

The procedure declaration adds a parameter list to the PL/SQL block. In this example, `student_id` is a parameter whose mode is IN. The mode of a parameter indicates whether the parameter passes data to a procedure (IN), returns data from a procedure (OUT), or can do both (IN OUT). The parameter `gpa` is an OUT parameter. It returns a value, but you cannot use it to pass a value to the procedure. Nor can you read its value inside the procedure, even after a value has been assigned to it.

## Stored Procedures

You can store PL/SQL procedures in the database, and call these stored procedures from Oracle applications. Storing a procedure in the database offers many advantages. Only one copy of the procedure needs to be maintained, it is in the database, and it can be accessed by many different applications. This considerably reduces maintenance requirements for large applications. A stored procedure is not recompiled each time it is called.

Procedures can be stored in the database using Oracle tools such as SQL\*Plus. You create the source for the procedure using your text editor, and execute the source using SQL\*Plus (for example, with the @ operator). When you input the source, use the CREATE PROCEDURE command. (You can also use CREATE OR REPLACE PROCEDURE, to replace an already stored procedure of the same name.)

See the *Oracle Database Reference* for complete information about the CREATE PROCEDURE command.

## Stored Packages

The examples of stored procedures shown so far in this chapter involve standalone procedures (sometimes called top-level procedures). These are useful in small applications. But, to gain the full power of stored procedures, you should use packages.

A package encapsulates procedures, as well as other PL/SQL objects. Stored packages that are used with Ada applications have two parts: a package specification and a package body. The specification is the (exposed) interface to the host application; it declares the procedures that are called by the application. A complete PL/SQL package specification can also declare functions, as well as other PL/SQL objects such as constants, variables, and exceptions. However, an Ada application using SQL\*Module cannot access or reference PL/SQL objects other than subprograms. The package body contains the PL/SQL code that defines the procedures and other objects that are declared in the package specification.

Although an Ada application can only access public subprograms, a called subprogram can in turn call private subprograms, and can access public and private variables and constants in the package.

For complete information about stored packages, see the *PL/SQL User's Guide and Reference*.

## Accessing Stored Procedures

You can use SQL\*Module to provide a bridge that enables your host application to access procedures stored in the database. A host application written in Ada cannot call a stored database subprogram directly. But you can use SQL\*Module to construct an interface procedure ("stub") that calls the stored database subprogram. [Table 3-1](#) shows, in schematic form, how this process works.

Figure 3-1 Accessing a Stored Procedure

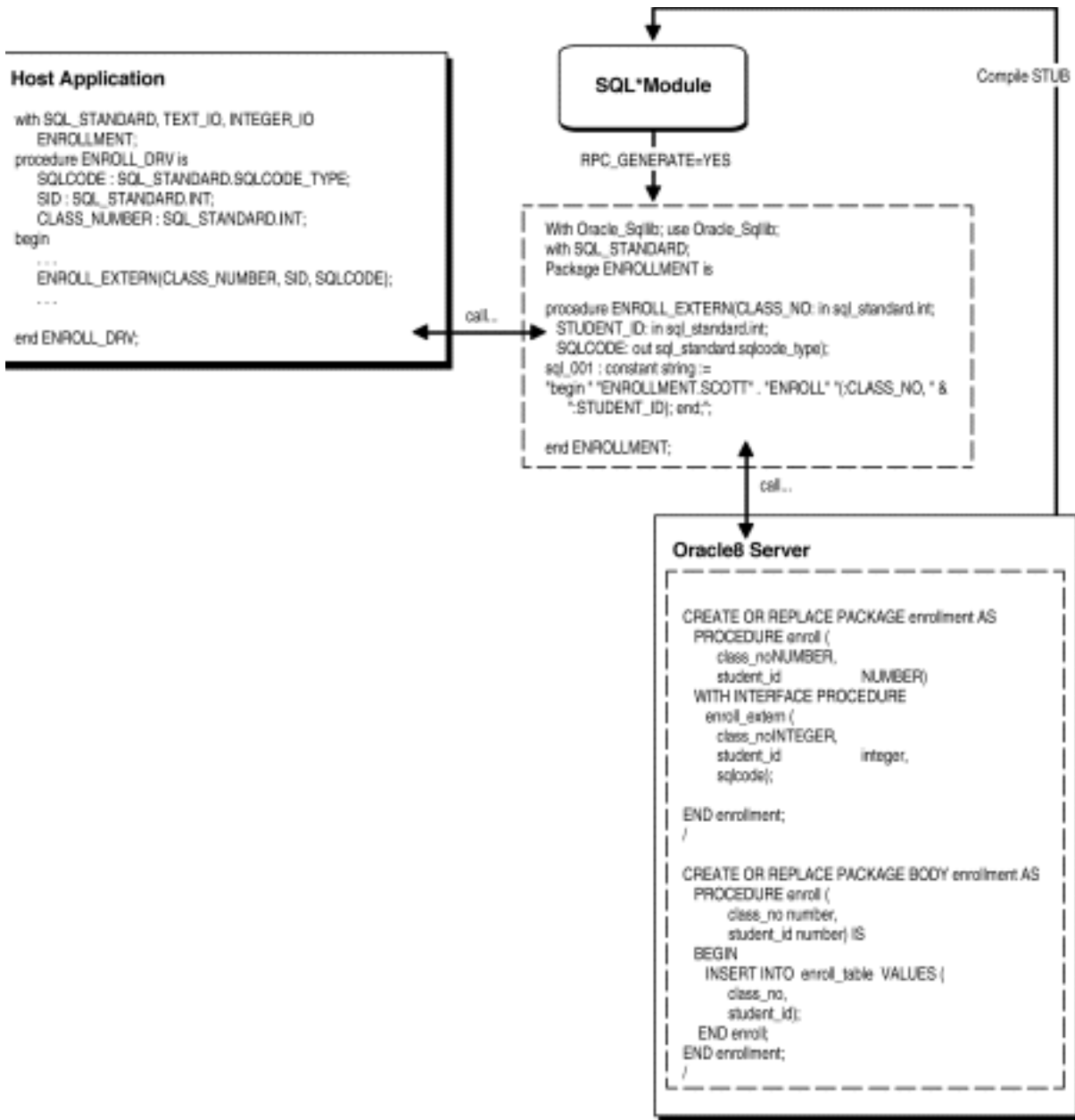

In this example, there is a procedure stored in the database called enroll. The PL/SQL source code that created the procedure is shown in the right-hand box. The WITH INTERFACE clause in the procedure is described in the section "The WITH INTERFACE Clause" on page 3-9. The procedure has two database parameters: class\_no and student\_id. The SQLCODE error return parameter is added in the interfacing clause.

### Case of Package and Procedure Names

The Oracle Server always translates to uppercase the names of database objects as they are inserted into the database. This includes the names of packages and procedures. For example, if you are loading a package into the database in the SCOTT schema, and have a PL/SQL source file that contains the line

```
CREATE PACKAGE school_records AS ...
```

then Oracle inserts the name into the schema as SCHOOL\_RECORDS, not the lowercase "school\_records". The following SQL\*Module command (in UNIX)

```
modada rpc_generate=yes pname=school_records userid=scott
```

generates an error, since there is no package named "school\_records" in the schema.

If you prefer to have your package and procedure names stored in lowercase in the database, you must quote all references to the name in the PL/SQL source file, or as you insert them into the database using SQL\*Plus. So, you would code

```
CREATE PACKAGE "school_records" AS ...
```

Note also that SQL\*Module preserves the case of subprogram names when creating interface procedure files.

However, if you really do want uppercase names, some operating systems (OPEN VMS is an example) require that you quote the name when you specify it on the command line. So, you would enter the command as

```
modada rpc_generate=yes pname="SCHOOL_RECORDS" user=scott
```

See your system-specific Oracle documentation, and your operating system documentation, for additional information on case conventions for command lines that are in effect for your operating system.

## Early and Late Binding

When you generate RPCs (remote procedure calls) using SQL\*Module, you have a choice of early binding or late binding. Your choice of early or late binding is controlled by the BINDING option.

When you choose early binding, SQL\*Module generates a call to the procedure stored in the database, and also uses a time stamp that is associated with the call. The time stamp records the date and time (to the nearest second) that the stored procedure was last compiled. The time stamp is created by the Oracle database. If a host application calls the stored procedure through the interface procedure, and the time stamp recorded with the interface procedure is earlier than the time stamp on the stored procedure recorded in the database, an error is returned to the host application in the SQLCODE and/or SQLSTATE status parameter. The SQLCODE error is 4062 "time stamp of name has been changed".

The late binding option, on the other hand, does not use a time stamp. If your application calls a stored procedure that has been recompiled since SQL\*Module generated the interface procedure, no error is returned to the application.

With late binding, SQL\*Module generates the call to the stored procedure using an anonymous PL/SQL block. The following example shows a specification for a stored procedure that is part of a package in the SCOTT schema:

```
PACKAGE emppkg IS

    PROCEDURE get_sal_comm (emp_num    IN    NUMBER,
                           salary      OUT NUMBER,
                           commission  OUT NUMBER)

    WITH INTERFACE
    PROCEDURE get_sal_emp (
                           emp_num    INTEGER,
                           salary      REAL,
```

```
commission REAL INDICATOR comm_ind,  
comm_ind SMALLINT,  
SQLCODE);  
  
END emppkg;
```

If you generate an RPC interface procedures output file for the package using the command

```
modada pname=EMPPKG rpc_generate=yes binding=late userid=scott/tiger
```

SQL\*Module generates a call in the output file, as follows:

```
With Oracle_SqlLib; use Oracle_SqlLib;  
with SQL_STANDARD;  
Package EMPPKG is  
  
procedure GET_SAL_EMP(EMPNUM: in sql_standard.int;  
SALARY: out sql_standard.real;  
COMMISSION: out sql_standard.real;  
COMM_IND: out sql_standard.smallint;  
SQLCODE: out sql_standard.sqlcode_type);  
sql_001 : constant string :=  
"begin "EMPPKG.SCOTT"." &  
  ""GET_SAL_COMM"(:EMPNUM, :SALARY, :COMMISSION:COMM_IND); end;";  
  
end EMPPKG;  
...
```

In other words, the call to the stored procedure `get_sal_comm` is performed using an anonymous PL/SQL block. This is the way stored procedures are called from an Oracle precompiler or Oracle Call Interface application.

The advantages of late binding are

- greater flexibility
- changes in the stored procedure(s) are transparent to the user
- gives behavior similar to interactive SQL (for example, SQL\*Plus)

The disadvantages of late binding are

- There might be additional performance overhead at runtime, due to the necessity of compiling the PL/SQL anonymous block.
- It is difficult to detect runtime PL/SQL compilation errors in the host application. For example, if the anonymous block that calls the late-bound procedure fails at runtime, there is no convenient way for the host application to determine the cause of the error.
- The lack of time-stamp capability means that changes, perhaps radical changes, in the stored procedure could be made after the host application was built, and the application would have no way of detecting this.

Use the `BINDING={EARLY | LATE}` command line option to select early or late binding when generating RPC interface procedures. See [Chapter 5, "Running SQL\\*Module"](#) for a description of this and other command line options.



## Cursor Variables

You can use cursor variables in your application. A cursor variable is a reference to a cursor that is defined and opened on the Oracle8 server. See the *PL/SQL User's Guide and Reference* for complete information about cursor types.

The advantages of cursor variables are

- Encapsulation: queries are centralized, placed in the stored procedure that opens the cursor variable. The logic is hidden from the user.
- Ease of maintenance: if you need to change the cursor, you only need to make the change in one place: the stored procedure. There is no need to change each application.
- Convenient security: the user of the application is the username used when the application connects to the server. The user must have execute permission on the stored procedure that opens the cursor. But the user does not need to have read permission on the tables used in the query. This capability can be used to limit access to the columns and rows in the table.

### Cursor Variable Parameters

You define a cursor variable parameter in your module using the type `SQL_CURSOR`. For example:

```
PROCEDURE alloc_cursor (
    SQLCODE,
    :curs SQL_CURSOR);
```

In this example, the parameter `curs` has the type `SQL_CURSOR`.

### Allocating a Cursor Variable

You must allocate the cursor variable. You do this using the Module Language command `ALLOCATE`. For example, to allocate the `SQL_CURSOR` `curs` that is the formal parameter in the example above, you write the statement:

```
ALLOCATE :curs;
```

Note: You use the `ALLOCATE` command only for cursor variables. You do not need to use it for standard cursors.

### Opening a Cursor Variable

You must open a cursor variable on the Oracle Server. You cannot use the `OPEN` command that you use to open a standard cursor to open a cursor variable. You open a cursor variable by calling a PL/SQL stored procedure that opens the cursor (and defines it in the same statement).

For example, consider the following PL/SQL package, stored in the database:

```
CONNECT scott/tiger

CREATE OR REPLACE PACKAGE cursor_var_pkg AS

    TYPE emp_record_type IS RECORD (ename EMP.ename%TYPE);
    TYPE curtype IS REF CURSOR RETURN emp_record_type;

    PROCEDURE OPEN1(curl IN OUT curtype)
    WITH INTERFACE
```

```

PROCEDURE
    OPEN1 (SQLCODE integer, cur1 SQL_CURSOR);

end cursor_var_pkg;

CREATE OR REPLACE PACKAGE BODY cursor_var_pkg AS

    PROCEDURE OPEN1(cur1 IN OUT curtype) IS
    BEGIN
        OPEN cur1 FOR SELECT ename FROM emp_view;
    END;
END cursor_var_pkg;

COMMIT;

```

After you have stored this package, and you have generated the interface procedures, you can open the cursor `curs` by calling the `OPEN1` stored procedure from your Ada driver program. You can then call module procedures that `FETCH` the next row from the opened cursor. For example:

```

PROCEDURE fetch_from_cursor (
    SQLCODE,
    :curs SQL_CURSOR,
    :emp_name VARCHAR2(11));

    FETCH :curs INTO :emp_name;

```

In your driver program, you call this procedure to fetch each row from the result defined by the cursor. When there is no more data, the value +100 is returned in `SQLCODE`.

Note: When you use `SQL*Module` to create the interface procedure to call the stored procedure that opens the cursor variable, you must specify `BINDING=LATE`. Early binding is not supported for cursor variables in this release.

### Opening in a Stand-alone Stored Procedure

In the example above, a cursor type was defined inside a package, and the cursor was opened in a procedure in that package. But it is not always necessary to define a cursor type inside the package that contains the procedures that open the cursor.

If you need to open a cursor inside a stand-alone stored procedure, you can define the cursor in a separate package, then reference that package in the stand-alone stored procedure that opens the cursor. Here is an example:

```

PACKAGE dummy IS
    TYPE EmpName IS RECORD (name VARCHAR2(10));
    TYPE emp_cursor_type IS REF CURSOR RETURN EmpName;
END;

-- and then define a stand-alone procedure:
PROCEDURE open_emp_curs (
    emp_cursor IN OUT dummy.emp_cursor_type;
    dept_num   IN   NUMBER) IS
BEGIN
    OPEN emp_cursor FOR
        SELECT ename FROM emp WHERE deptno = dept_num;
END;

END;

```

## Return Types

When you define a reference cursor in a PL/SQL stored procedure, you must declare the type that the cursor returns. See the *PL/SQL User's Guide and Reference* for complete information on the reference cursor type and its return types.

## Closing a Cursor Variable

Use the Module Language CLOSE command to close a cursor variable. For example, to close the emp\_cursor cursor variable that was OPENed in the examples above, use the statement

```
CLOSE :emp_cursor;
```

Note that the cursor variable is a parameter, and so you must precede it with a colon.

You can reuse ALLOCATED cursor variables. You can OPEN, FETCH, and CLOSE as many times as needed for your application. However, if you disconnect from the server, then reconnect, you must reallocate cursor variables.

## Restrictions on Cursor Variables

The following restrictions apply to the use of cursor variables:

1. You can only use cursor variables with the commands:
  - ALLOCATE
  - FETCH
  - CLOSE
2. The DECLARE CURSOR command does not apply to cursor variables.
  - You cannot FETCH from a CLOSED cursor variable.
  - You cannot FETCH from a non-ALLOCATED cursor variable.
  - Cursor variables cannot be stored in columns in the database.
  - A cursor variable itself cannot be declared in a package specification. Only the type of the cursor variable can be declared in the package specification.
  - A cursor variable cannot be a component of a PL/SQL record.

## Dynamic SQL

Dynamic SQL is the capability of executing SQL commands that are stored in character string variables. The package DBMS\_SQL parses Data Definition Language (DDL) and Data Manipulation (DML) statements at runtime. DBMS\_SQL has functions such as OPEN\_CURSOR, PARSE, DEFINE\_COLUMN, EXECUTE, FETCH\_ROWS, COLUMN\_VALUE, etc. Use these functions in your program to open a cursor, parse the statement, and so on.

For more details on this package, see *Oracle Database Application Developer's Guide - Fundamentals*

## The WITH INTERFACE Clause

The stored procedure format in the previous section can be used for stored procedures that are to be called from applications written using Oracle tools. For example, a

SQL\*Plus script can call the GET\_GPA procedure in "Procedures" on page 3-2 just as it is written.

You can code a WITH INTERFACE clause, or you can let SQL\*Module generate a default WITH INTERFACE clause for stored procedures that have been stored without this clause.

This clause, when added to a procedure declaration in the package specification, lets you add parameters that are essential to perform an RPC to a PL/SQL procedure, through a calling interface procedure in the output file. In addition, the WITH INTERFACE clause uses SQL datatypes, not the PL/SQL datatypes that are used in the stored procedure definition. The additional features of the WITH INTERFACE clause are

- use of SQL datatypes
- optional indicator parameters
- use of the SQLSTATE and SQLCODE status parameters

Note: The procedures names that you code in WITH INTERFACE clauses must be unique within the entire application. If you let SQL\*Module generate default WITH INTERFACE, then overloaded procedure names are resolved using an algorithm described in "MAPPING" on page 5-13.

Arrays are not allowed in WITH INTERFACE clauses.

## Examples

The following package declaration shows how you use the WITH INTERFACE clause to map PL/SQL datatypes to SQL datatypes, and add the SQLCODE and/or SQLSTATE status parameters. Status parameters are filled in automatically as the procedure executes. They are not directly accessible within the procedure body.

```
CREATE or REPLACE PACKAGE gpa_pkg AS
  PROCEDURE get_gpa (student_id IN NUMBER,
                    gpa          OUT NUMBER)
  WITH INTERFACE
  PROCEDURE get_gpa_if
    (student_id  INTEGER,
     gpa         REAL,
     SQLCODE    INTEGER
     SQLSTATE   CHARACTER(6));
...

```

The interface procedure name specified in the WITH INTERFACE clause can be the same as the name of the procedure itself, or, as in this example, it can be different. However, the name specified in the WITH INTERFACE clause is the name that must be used when you invoke the stored procedure from your host application.

In the example above, the datatypes in the WITH INTERFACE clause are SQL datatypes (INTEGER and REAL). These types are compatible with the PL/SQL datatype NUMBER.

You must include either a SQLCODE or a SQLSTATE parameter in the parameter list of the WITH INTERFACE clause. You can include both. SQLSTATE is the recommended parameter; SQLCODE is provided for compatibility with the SQL89 standard.

Note: Parameters in the PL/SQL procedure specification cannot be constrained. Parameters in the WITH INTERFACE clause must be constrained where required.

The following package definition shows an example of the WITH INTERFACE clause:

```
CREATE OR REPLACE PACKAGE gpa_pkg AS

    PROCEDURE get_gpa(student_id      IN      NUMBER,
                     student_last_name IN OUT CHARACTER,
                     gpa              OUT    NUMBER)

    WITH INTERFACE
    PROCEDURE get_gpa_if
        (student_id      INTEGER,
         student_last_name CHARACTER(15)
                                         INDICATOR sname_ind,
         sname_ind       SMALLINT,
         gpa              REAL,
         SQLSTATE        CHARACTER(6),
         SQLCODE         INTEGER);

END;
```

In the example above, the `student_last_name` parameter is a `CHARACTER`, which is both a PL/SQL and a SQL datatype. In the PL/SQL part of the procedure definition, the parameter must be unconstrained, following the syntax of PL/SQL. But in the WITH INTERFACE clause, you must specify the length of the parameter.

The `student_last_name` parameter also takes an indicator parameter, using the syntax shown. See Appendix B for the formal syntax of the WITH INTERFACE clause.

## SQL Datatypes

The SQL datatypes that you can use in the WITH INTERFACE clause are listed in [Table 3–1](#), along with their compatible PL/SQL datatypes.

**Table 3–1 SQL Datatypes**

SQL Datatypes	Range or Size	SQL Meaning	Compatible PL/SQL Datatypes
CHARACTER (N) OR CHAR (N)	1 < N < 32500 bytes	String of length N (if N is omitted, N is effectively 1)	VARCHAR2(N), CHAR(N), DATE
DOUBLE PRECISION	Implicit precision 38	Approximate numeric type	NUMBER
INTEGER or INT	System specific	Integer type	NUMBER, BINARY_ INTEGER
SMALLINT	System specific	Small (or short) integer type	NUMBER, BINARY_ INTEGER
REAL	System-specific	Approximate numeric type	NUMBER
VARCHAR2(N)	1 < N < 32500 bytes	Character array of length N	VARCHAR2(N), CHAR(N),DATE
SQL_CURSOR		Cursor variable type	REF cursor

**Table 3–1 (Cont.) SQL Datatypes**

SQL Datatypes	Range or Size	SQL Meaning	Compatible PL/SQL Datatypes
Notes			
1. SQL datatypes compatible with NUMBER are also compatible with types derived from NUMBER, such as REAL.			
2. The size of integer and small integer types is system specific. For many systems, integers are 32 bits wide and small integers are 16 bits, but check your system documentation for the size on your system.			

**DATE Datatype**

SQL\*Module does not directly support the Oracle DATE datatype. You can, however, use character strings when you fetch, select, update, or insert DATE values. Oracle does the conversion between internal DATES and character strings. See the *Oracle Database Reference* for more information about the DATE datatype, and conversion between DATES and character strings.

**The Default WITH INTERFACE Clause**

If a package has already been defined in the database with no WITH INTERFACE clauses for the subprograms, you can still generate interface procedures to call the subprograms. The default WITH INTERFACE clause that is generated by SQL\*Module when there is no WITH INTERFACE clause in the package or procedure gives you all the features of the standard WITH INTERFACE clause:

- the SQLCODE error handling parameter
- the SQLSTATE error handling parameter
- indicator parameters
- datatype mapping between PL/SQL base and derived datatypes and SQL types

**Procedures**

When SQL\*Module generates an interface procedure with a default WITH INTERFACE clause, it generates a SQLCODE parameter in the first parameter position, and a SQLSTATE parameter in the second position. Then, for each actual parameter in the stored procedure or stored function, a parameter is generated with the appropriate mapped host language datatype. Each parameter is followed by an indicator parameter, mapped to the correct host language type from the SQL datatype SMALLINT.

**Functions**

If SQL\*Module is generating a default WITH INTERFACE clause for functions in a package, then the WITH INTERFACE clause is generated as if the function were a procedure, with the return value and its indicator parameter as the last two parameters in the clause.

Table 3–2 shows how predefined, or base, PL/SQL datatypes are mapped to SQL datatypes, and then to host language datatypes. PL/SQL subtypes that are derived from the base types are also supported, and are mapped as indicated for the base type.

**Table 3–2 Mapping PL/SQL Datatypes to SQL Datatypes**

PL/SQL Datatype	Ada Language Datatype
BINARY INTEGER	SQL_STANDARD.INT
NUMBER	SQL_STANDARD.
NUMBER(P,S)	DOUBLE_PRECISION
RAW	STRING
LONG RAW	
LONG	STRING
BOOLEAN	SQL_STANDARD.INT
CHAR	SQL_STANDARD.CHAR
VARCHAR2	STRING
DATE	SQL_STANDARD.CHAR
ROWID	STRING
CURSOR	ORACLE_SQLLIB.SQL_CURSOR
Notes	
Maximum length of a STRING is 32500 bytes.	
Maximum length of a DATE is 2048 bytes.	
Maximum length of ROWID and MLSLABEL is 256 bytes.	

Suppose, for example, that a procedure stored in the SCOTT schema has the parameter list

```
PROCEDURE procl (
    PARAM1 IN    NUMBER,
    PARAM2 IN OUT DATE,
    PARAM3  OUT DOUBLE PRECISION,
    PARAM4  CHARACTER,
    PARAM5  BINARY_INTEGER)
```

If you run the module compiler, modada, as follows:

```
modada pname=PROC1 rpc_generate=yes user=scott/tiger oname=procl
```

then the Ada procedure specification in the generated output file procl\_a would be created by SQL\*Module as follows:

```
procedure PROC1(SQLCODE: in out sql_standard.sqlcode_type;
  sqlstate: in out sql_standard.sqlstate_type;
  PARAM1: in sql_standard.double_precision;
  PARAM1_ind: in sql_standard.smallint;
  PARAM2: in out oracle_sqllib.sql_date;
  PARAM2_ind: in out sql_standard.smallint;
  PARAM3: out sql_standard.double_precision;
  PARAM3_ind: out sql_standard.smallint;
  PARAM4: in string;
  PARAM4_ind: in sql_standard.smallint;
  PARAM5: in sql_standard.int;
  PARAM5_ind: in sql_standard.smallint);
```

Function calls are generated as procedures with the last two parameters in the generated prototype being the return parameter and the indicator variable for the return parameter. For example:

```
FUNCTION func1 (
    PARAM1 IN NUMBER) RETURN VARCHAR2
```

would have the Ada prototype:

```
procedure FUNC1(SQLCODE: in out sql_standard.sqlcode_type;
    sqlstate: in out sql_standard.sqlstate_type;
    PARAM1: in sql_standard.double_precision;
    PARAM1_ind: in sql_standard.smallint;
    mod_func_return: out string;
    mod_func_return_ind: out sql_standard.smallint) is
begin
    . . .

end FUNC1;
```

## Storing Module Language Procedures

You can also use SQL\*Module to create a stored package in the database from Module Language procedures. By specifying the module file in the INAME command line option (see [Chapter 5, "Running SQL\\*Module"](#) for details), and setting the option STORE\_PACKAGE=YES, the procedures in the module file are stored in a package in the database, using the module name as the default package name. (The default name can be overridden using the PNAME option. See [Chapter 5, "Running SQL\\*Module"](#) for details.)

For example, the following module file:

```
MODULE          test_sp
AUTHORIZATION   scott

PROCEDURE get_emp (
    :empname     CHAR(10),
    :empnumber   INTEGER,
    SQLCODE);
SELECT ename INTO :empname
FROM emp
WHERE empno = :empnumber;

PROCEDURE put_emp (
    :empname     CHAR(10),
    :empnumber   INTEGER,
    :deptnumber  INTEGER,
    SQLCODE);
INSERT INTO emp (ename, empno, deptno) VALUES
(:empname, :empnumber, :deptnumber);
```

when stored as a package in the database would produce the following PL/SQL code for the package specification:

```
package test_sp is
procedure get_emp
    (empname out char,
    empnumber in number)
with interface procedure get_emp
    (empname char(11),
    empnumber integer,
    sqlcode integer);
procedure put_emp
```



```
(empname in char,  
empno in number,  
deptno in number)  
with interface procedure put_emp  
(empname char(11),  
empnumber integer,  
deptnumber integer,  
sqlcode integer);  
end test_sp;
```

Note: You cannot store module procedures that contain the `ALLOCATE` statement, nor statements `CONNECT`, `DISCONNECT`, `ENABLE THREADS`, `CONTEXT`, nor `FETCH` and `CLOSE` statements that refer to cursor variables.

## Connecting to a Database

When you write an Ada program that calls RPC interface procedures that were generated from stored procedures, you need a way to connect to a database at runtime. The steps you can take to do this are

- Write a module that contains connect and disconnect procedures. See "[CONNECT Statement](#)" on page 2-13 for the syntax of these procedures. See also the examples in the demomod sample in [Chapter 6, "Demonstration Programs"](#).
- Compile the module using `SQL*Module`.

Add a `with` clause to the host application file referencing the generated specification name.

- Compile the specification file.
- Compile the source output file.
- Link your main application.



---

## Developing the Ada Application

This chapter describes the criteria that a Ada application must meet when accessing module procedures, or when calling RPC stubs generated by SQL\*Module. Topics covered include

- [Program Structure](#)
- [Error Handling](#)
- [Obtaining the Number of Rows Processed](#)
- [Handling Nulls](#)
- [Cursors](#)
- [Specification Files](#)
- [Calling a Procedure](#)
- [Arrays as Procedure Arguments](#)
- [National Language Support](#)

The sample programs in this chapter are source code listings for the Module Language procedures that are called by the sample programs in [Chapter 6, "Demonstration Programs"](#), and a set of SQL statements that create and partially populate the example tables. These sources are also available on-line, in the *demo* directory.

### Program Structure

The developer determines the structure of an application program that uses SQL\*Module. A significant advantage that you obtain from using SQL\*Module is that it imposes very few special requirements or constraints on the program design, unlike some other SQL programmatic interfaces.

The code that you write is purely in the language of the host application program. There is no need for special declare sections, embedded SQL statements, and special error handling and recovery. Database operations are mostly transparent to the application program developer, being taken care of by the Module Language or PL/SQL stored procedures.

There are, however, some SQL concepts of which the host application developer must be aware

- error handling, and the use of the SQLSTATE and/or SQLCODE status parameter.
- the concept of *null*, and how to use indicator variables to handle it
- the concept of a cursor

## Error Handling

Each Module Language procedure that is called from the host application must contain a parameter that returns status information to the application. There are two status parameters that you can use: `SQLCODE` and `SQLSTATE`. `SQLCODE` returns an integer value, while `SQLSTATE` returns a five-character string that contains an alphanumeric code.

`SQLCODE` is provided for compatibility with applications written to the 1989 SQL standards; new applications should use the `SQLSTATE` parameter.

When calling stored database procedures through an RPC stub, you include `SQLCODE` and/or `SQLSTATE` in the parameter list of the `WITH INTERFACE` clause in the procedure's package specification. See "[The WITH INTERFACE Clause](#)" on page 3-9.

### SQLCODE

`SQLCODE` is an output parameter that can be included in a module procedure, and in the `WITH INTERFACE` clause in PL/SQL stored package specifications. `SQLCODE` returns a value that indicates whether a procedure completed successfully, completed with warnings, or did not complete due to an error.

`SQLCODE` returns three kinds of values:

0

Indicates that the procedure completed with no errors or warnings.

< 0

Indicates that an error occurred during execution of the procedure.

+100

Indicates that a SQL statement did not find a row on which to operate.

Negative `SQLCODE` values are Oracle message numbers. See the *Oracle Database Error Messages* manual for a complete list of Oracle codes and their accompanying messages. See the next section, "`SQLSTATE`", for mappings between Oracle error numbers and `SQLSTATE` values.

### Obtaining Error Message Text

The procedure `error_message` in the public package `oracle_sqllib` was introduced in release 8.0. This procedure obtains the text associated with the `SQLCODE` of the latest error returned. The prototypes are (with and without a runtime context):

```
procedure ERROR_MESSAGE (ctx oracle_sqllib.sql_context,
                        msg_buf system.address,
                        msg_buf_len sql_standard.int);
```

and:

```
procedure ERROR_MESSAGE (msg_buf:out      system.address,
                        msg_buf_len:out  sql_standard.int);
```

## SQLSTATE

SQLSTATE is a five-character alphanumeric output parameter that indicates the completion status of the procedure. It is declared as `SQL_STANDARD.SQLSTATE_TYPE`.

SQLSTATE status codes consist of a two-character class code followed by a three-character subclass code. Aside from the class code 00 ("successful completion"), the class code denotes the category of the exception. Also, aside from the subclass code 000 ("not applicable"), the subclass code denotes a specific exception within that category. For example, the SQLSTATE value '22012' consists of class code 22 ("data exception") and subclass code 012 ("division by zero").

Each of the five characters in a SQLSTATE value is a digit (0..9) or an uppercase Latin letter (A..Z). Class codes that begin with a digit in the range 0..4 or a letter in the range A..H are reserved for the predefined conditions (those defined in the SQL92 specification). All other class codes are reserved for implementation-defined sub-conditions. All other subclass codes are reserved for implementation-defined sub-conditions. Table 4-1 shows the coding scheme.

**Figure 4-1** SQLSTATE

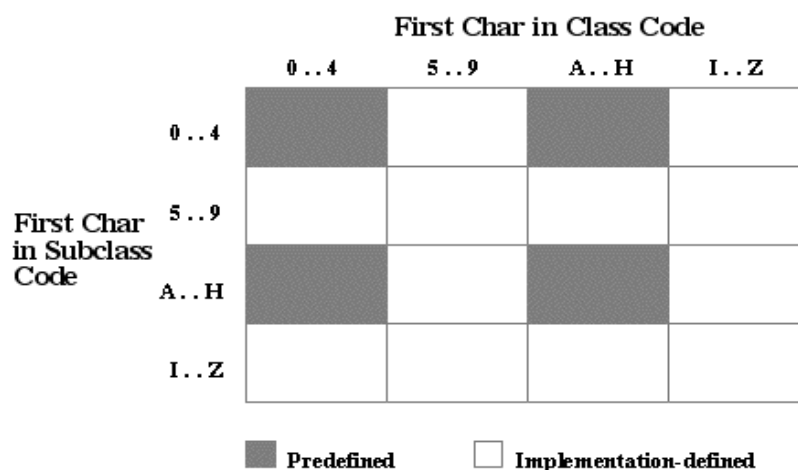

**Table 4-1** Predetermined Classes

Class	Condition
02	no data
07	dynamic SQL error
08	connection exception
0A	feature not supported
21	cardinality violation
22	data exception
23	integrity constraint violation
24	invalid cursor state
25	invalid transaction state
26	invalid SQL statement name
27	triggered data change violation

**Table 4-1 (Cont.) Predetermined Classes**

Class	Condition
28	invalid authorization specification
2A	direct SQL syntax error or access rule violation
2B	dependent privilege descriptors still exist
2C	invalid character set name
2D	invalid transaction termination
2E	invalid connection name
33	invalid SQL descriptor name
34	invalid cursor name
35	invalid condition number
37	dynamic SQL syntax error or access rule violation
3C	ambiguous cursor name
3D	invalid catalog name
3F	invalid schema name
40	transaction rollback
42	syntax error or access rule violation
44	with check option violation
HZ	remote database access

Note: The class code HZ is reserved for conditions defined in International Standard ISO/IEC DIS 9579-2, *Remote Database Access*.

[Appendix D, "SQLSTATE Codes"](#) shows how Oracle errors map to SQLSTATE status codes. In some cases, several Oracle errors map to a status code. In other cases, no Oracle error maps to a status code (so the last column is empty). Status codes in the range 60000 .. 99999 are implementation-defined.

## Obtaining the Number of Rows Processed

Starting with release 8.0, function `rows_processed`, in the public package `oracle_sqllib`, returns the number of rows processed by the last SQL statement.

The prototypes are:

```
function ROWS_PROCESSED return integer;
```

and

```
function ROWS_PROCESSED (ctx oracle_sqllib.sql_context) return integer;
```

where the context, `ctx`, has been allocated previously.

## Handling Nulls

A database column or a SQL expression can have a value, or it can have a special status called *null*. A null means the absence of a value. A numeric value or a special string encoding cannot be used to indicate a null, since all allowable numeric or string values are reserved for actual data. In a SQL\*Module application, you must use an

*indicator variable* to test a returned value for a null, or to insert a null into a database column.

Note: The term *indicator variable* is also referred to as an *indicator parameter* when discussing a variable being passed to or retrieved from a procedure.

## Indicator Variables

From the host language point of view, an indicator variable is a small integer that is passed to a procedure. In the SQL statement of the procedure, the indicator is associated with the corresponding host parameter. For example, the Module Language procedure below performs a simple one-row SELECT (the host parameter in the WHERE clause is assumed to be a primary key):

```
PROCEDURE get_commission (
    :commission REAL,
    :comm_ind SMALLINT,
    :emp_number INTEGER,
    SQLSTATE);
SELECT comm INTO :commission INDICATOR :comm_ind
FROM emp WHERE empno = :emp_number;
```

In an Ada application, you call this procedure and test for a possible null in the returned COMMISSION as follows:

```
EMPNO := 7499;
GET_COMMISSION (COMMISSION, COMM_INDICATOR, EMPNO, SQLSTATE);
if COMM_INDICATOR < 0 then
    PUT_LINE("Commission is null.");
else
    PUT("Commission is ");
    PUT(COMMISSION);
    NEW_LINE;
end if;
```

So if an indicator variable is less than zero when a procedure returns, the associated host parameter has an undefined value.

You can also associate indicator variables with input parameters, for column values that are used to insert a new row into a table, or update an existing row. If the value in the indicator variable is greater than or equal to zero, the value in the associated parameter is used as the input value. If the indicator variable is set to -1, the value in the associated parameter is ignored, and a null is inserted as the column value.

For example, the following module procedure inserts a new row into an inventory table:

```
PROCEDURE new_part (
    :part_no INTEGER,
    :description CHAR(200),
    :bin_number INTEGER,
    :bin_no_ind SMALLINT,
    SQLSTATE);

INSERT INTO inventory (part_number, description, bin_no)
VALUES (:part_no, :description,
        :bin_number INDICATOR :bin_no_ind);
```

When you call this procedure with the parameter *bin\_no\_ind* set to -1, any value in the parameter *bin\_number* is ignored, and a null is inserted into the BIN\_NO column of the table.

If the host language parameter is a character type, and has an associated indicator variable, a returned indicator value greater than zero indicates that the returned value was truncated. The value of the indicator is the original (un-truncated) length, in bytes, of the column or expression value.

## Cursors

Programs that retrieve data from a table can work in two different ways. In one case, a query might be constructed that expects either one row of data to be returned, or no row. For example, if the program performs a request such as "give me the name of the employee whose employee number is 7499", where the employee number is a primary key of the table (and hence, by definition, unique), the request either returns the name of the employee whose employee number is 7499, or returns an indication that no such employee exists in the table.

If no employee exists with that number, the query procedure returns a "no data found" indication in the SQLCODE or SQLSTATE parameter.

For Oracle to process any SQL statement, a cursor is required. However, SQL\*Module *implicitly* defines a cursor for INSERT, UPDATE, and DELETE statements, as well as SELECT statements.

However for queries that can return multiple rows, an explicit cursor must be defined in the module or stored package to fetch all the rows. You can use static cursors, or cursor variables. See "Cursors" on page 4-6 for a description of cursor variables.

See the code in "Module Language Sample Program" on page 6-7 for several examples that use explicit cursors.

## Specification Files

The SQL\*Module compiler generates specification files. These are text files that contain declarations for the module or interface procedures that SQL\*Module generates.

You must include the specification file directly in the source of your host application. The name of the specification file is the base name of the Module Language output file for SQL\*Module, with a system-specific extension. These extensions are documented in "Specification File" on page 5-7.

In Ada applications, you must compile the specification file (or files) that SQL\*Module generates. You then include the specification for the module procedures or stubs in each application that calls module procedures or stubs using the with context clause.

The naming of specification files is discussed in detail in [Chapter 6, "Demonstration Programs"](#).

## Calling a Procedure

You call procedures generated by SQL\*Module using the normal procedure call format of the host language. Procedures can only return values in parameters, including the SQLCODE and SQLSTATE parameters. The generated procedures are not functions.



## Arrays as Procedure Arguments

SQL\*Module supports array bind and define variables as arguments to procedures and functions:

```
PROCEDURE foo (:arrname ARRAY(n) OF type, SQLCODE);
```

where n is the size of arrname, and type is listed in "National Language Support" on page 4-7.

For example:

```
PROCEDURE selempno (:eno ARRAY(14) OF INTEGER, SQLCODE);
  SELECT empno INTO :eno FROM emp;
```

Note: Host arrays are allowed in SELECT, FETCH, INSERT, UPDATE and DELETE statements only.

Restrictions:

1. Arrays may not be specified when RPC\_GENERATE=yes or STORE\_PACKAGE=yes. See "Stored Packages" on page 3-3 for more information. See both these command-line options in Chapter 5, "Running SQL\*Module".
2. The maximum dimension of an array is 32000
3. SQL\*Module does not allow multi-dimension arrays.

## National Language Support

Not all writing systems can be represented using the 7-bit or 8-bit ASCII character set. Some languages require multi-byte character sets. Also, countries have differing ways of punctuating numbers, and representing dates and currency symbols.

Oracle provides National Language Support (NLS), which lets you process single-byte and multi-byte character data and convert between character sets. It also lets your applications run in different language environments. With NLS, number and date formats adapt automatically to the language conventions specified for a user session. Thus, NLS allows users around the world to interact with Oracle in their native languages.

You control the operation of language-dependent features by specifying various NLS parameters. Default values for these parameters can be set in the Oracle initialization file. The following table shows what each NLS parameter specifies:

NLS Parameter	Specifies ...
NLS_LANGUAGE	language-dependent conventions
NLS_TERRITORY	territory-dependent conventions
NLS_DATE_FORMAT	date format
NLS_DATE_LANGUAGE	language for day and month names
NLS_NUMERIC_CHARACTERS	decimal character and group separator
NLS_CURRENCY	local currency symbol
NLS_ISO_CURRENCY	ISO currency symbol
NLS_SORT	sort sequence

The main parameters are NLS\_LANGUAGE and NLS\_TERRITORY. NLS\_LANGUAGE specifies the default values for language-dependent features, which include

- language for Server messages
- language for day and month names
- sort sequence

NLS\_TERRITORY specifies the default values for territory-dependent features, which include

- date format
- decimal character
- group separator
- local currency symbol
- ISO currency symbol

You can control the operation of language-dependent NLS features for a user session by specifying the parameter NLS\_LANG as follows:

```
NLS_LANG = <language>_<territory>.<character set>
```

where *language* specifies the value of NLS\_LANGUAGE for the user session, *territory* specifies the value of NLS\_TERRITORY, and *character set* specifies the encoding scheme used for the terminal. An *encoding scheme* (usually called a character set or code page) is a range of numeric codes that corresponds to the set of characters a terminal can display. It also includes codes that control communication with the terminal.

You define NLS\_LANG as an environment variable (or the equivalent on your system). For example, on UNIX using the C shell, you might define NLS\_LANG as follows:

```
setenv NLS_LANG French_Canadian.WE8ISO8859P1
```

SQL\*Module fully supports all the NLS features that allow your applications to process multilingual data stored in an Oracle8 database. For example, you can run a SQL\*Module-derived client application that interacts with a remote server, where the client and the server are using different character sets, possibly with a different number of bytes per character. In these contexts, remember that specification of the lengths of string types, such as the SQL datatype CHARACTER(N), is always specified in *bytes*, not characters.

You can even pass NLS parameters to the TO\_CHAR, TO\_DATE, and TO\_NUMBER functions. For more information about NLS, see the *Oracle Database Application Developer's Guide - Fundamentals*.

---

## Running SQL\*Module

This chapter describes

- [SQL\\*Module Input and Output](#)
- [Invoking SQL\\*Module](#)
- [Case Sensitivity in Program Names, Option Names, and Values](#)
- [How to Specify Command-Line Options](#)
- [Input Files](#)
- [Output Files](#)
- [Command-Line Options](#)
- [Compiling and Linking](#)

### SQL\*Module Input and Output

This section reviews the different ways that you can use the SQL\*Module compiler. This material was discussed in detail in [Chapter 2, "Module Language"](#) and [Chapter 3, "Accessing Stored Procedures"](#); here it is presented in terms of the ways that you run the compiler, using the command-line options to get different SQL\*Module functionality.

#### Input sources

Input to the compiler can come from two sources:

- module files written according to the SQL standard Module Language specifications, as described in [Chapter 2, "Module Language"](#) of this Guide
- stored packages and procedures in an Oracle database (see [Chapter 3, "Accessing Stored Procedures"](#))

You use a standard text editor to create module files, just as you would create a host language application.

Stored procedures can be stand-alone procedures, or they can be encapsulated in a stored package. You normally create PL/SQL code for stored packages and procedures using a text editor, and then store it in a database using an Oracle tool such as SQL\*Plus. You can also use SQL\*Module to encapsulate Module Language procedures in a package, and store them in the database.

## Output Files

The *output source file* is always the host language code file that SQL\*Module generates from the input source. There are also other output files, such as the *listing file* and *specification file*. You can run SQL\*Module and generate *no* output source file, for example if you just want to store procedures in the database from a Module Language input file, or you just want to generate a listing file.

You compile output source files using the host language compiler, and link the resulting object files together with the host application's object files to produce the executable program. See the section "[Compiling and Linking](#)" on page 5-17 for more information about handling output files.

Note: While many of the examples in this chapter assume, for simplicity, that the input and output files are in the same directory, this does not have to be the case. Input and output files can be in separate directories, and you can use the various NAME options to specify the source of input, or the destination of output.

## Determining the Input Source

There are three sources of input for SQL\*Module, and four ways to determine the input:

1. When compiling a module written in Module Language, the source is the Module Language code file.
2. When generating RPC stubs from stored procedures, there is no input file. The source of the input is the stored package in the database.
3. When creating a stored package in the database from a Module Language module file, the source is the Module Language file.
4. You can combine methods 1 and 2 in one invocation of SQL\*Module. A package in the database is created from the Module Language module file, and an output file that contains RPC stubs to call the database package procedures is produced.

Methods 1 and 4 are the most common ways to use SQL\*Module. Method 1 is described in [Chapter 2, "Module Language"](#) of this Guide, method 2 in [Chapter 3, "Accessing Stored Procedures"](#). Methods 3 and 4 are much more specialized, and are described in [Chapter 3, "Accessing Stored Procedures"](#).

STORE\_PACKAGE

Determines whether SQL\*Module should store a package in the database.

RPC\_GENERATE

Determines whether an interface procedure output file is produced. When you specify the option RPC\_GENERATE as YES, the option PNAME specifies the name of the package in the database that provides the input source.

[Table 5–1](#) shows the how the command-line option values for STORE\_PACKAGE and RPC\_GENERATE, together with the values for INAME and PNAME, determine the input source.

**Table 5–1 Datatypes**

Input Source	Options			
	STORE_ PACKAGE	RPC_ GENERATE	INAME	PNAME

**Table 5–1 (Cont.) Datatypes**

Input Source	Options			
(1) Module source file	=NO	=NO	Module file name	N/A
(2) Procedure already stored in database	=NO	=YES	N/A	Stored package or procedure name
(3) Module file to create SPs in database	=YES	=NO	Module file name	Database package name (if not specified, becomes same as module filename)
(4) Store module procedures, then do (2)	=YES	=YES	Module file name	Database package name (if not specified, becomes same as module filename)

See the section "[Command-Line Options](#)" on page 5-8 for a detailed description of these options. See the section "[Compiling and Linking](#)" on page 5-17, for examples that show you how you can use these options. For an explanation of the default file naming conventions, see the sections "[Input Files](#)" on page 5-6 and "[Output Files](#)" on page 5-6.

## Invoking SQL\*Module

You can run the SQL\*Module compiler interactively from the operating system command line, from a command in a batch file, or, for some operating systems, a *makefile*. The way you invoke the compiler can be system dependent. See your system-specific Oracle documentation to find out the location on your system of the compiler and associated files, such as configuration files and the SQL runtime library.

## Running the Compiler

The name of the SQL\*Module compiler itself is *modada* for Ada. The SQL\*Module compiler can be invoked from the operating system command line as follows:

```
modada <option=value> ...
```

where <option=value> is a command-line argument. For example, the command

```
modada iname=my_test1.mad oname=my_test1_mod.a userid=modtest
```

compiles the module file *my\_test1.mad* to produce an output file called *my\_test1\_mod.a*. The username is *modtest*. Since in this example no password was provided on the command line, SQL\*Module prompts you for one when it starts. SQL\*Module requires a valid username and password to compile a Module Language file. The objects referenced in the cursors and procedures in the Module file must be available in the schema named (MODTEST in this example) when you run SQL\*Module.

When you use SQL\*Module to generate interface procedure files that call stored procedures in the database, you must specify the same USERID as the schema that owns the stored procedures.

## Case Sensitivity in Program Names, Option Names, and Values

For operating systems that are case sensitive, such as UNIX, the names of the executables are normally in lowercase. For all systems, the names of the options and their values are not case sensitive. In this Guide, the option name is in uppercase, and the value is in lower case. However, when the option value is a filename, and your operating system is case-sensitive, you must enter the filename using the correct combination of upper and lowercase

### Listing Options and Default Values

If you provide no command-line arguments, or the only argument is '?', the compiler prints a list of all the options available, with their current default values. For example, the command

```
modada ?
```

runs the SQL\*Module compiler for Ada and lists each option with its default value. See "[Default Values](#)" on page 5-5 for information on what determines the defaults. (Be sure to escape the '?' using '\ ' if you are running on a UNIX system and you are using the C shell.)

If you just want to see the default value for a single option, you can issue the command:

```
modada <OPTION>=?
```

For example, the command

```
modada OUTPUT=?
```

shows the default values for the OUTPUT option for the SQL\*Module compiler for Ada.

```
modada
```

produces a short help display.

A complete description of each option is given later in this chapter.

## How to Specify Command-Line Options

The value of an option is a string literal, which can represent text or numeric values. For example, for the option

```
INAME=my_test
```

the value is a string literal that specifies a filename. But for the option

```
MAXLITERAL=400
```

the value is numeric.

Some options take Boolean values, and these may be represented with the strings "yes" or "no", or "true" or "false" (in upper or lowercase). For example:

```
... STORE_PACKAGE=YES
```

is equivalent to

```
... STORE_PACKAGE=true
```

both of which mean that the results of the compilation should be stored as a package in the database.

The option value is always separated from the option name by an equals sign, with *no whitespace* between the name or the value and the equals sign.

## Value Lists

Some options can take multiple values. Multiple option values are specified in a list. The list is a comma-separated list of values with surrounding parentheses. Do *not* put any whitespace in the list. The following option specifies that SQL\*Module should generate source code and specification output files, but not listing files:

```
... OUTPUT=(CODE,SPECIFICATION)
```

A value list completely supersedes the value list specified by a previous default or option value list. For example, if the system configuration file contains the line

```
OUTPUT=(CODE,SPECIFICATION,LIST)
```

and there is no user configuration file, and the command line contains the option

```
... OUTPUT=(CODE,LIST)
```

then the value of OUTPUT is (CODE,LIST). See the section ["Configuration Files"](#) on page 5-6 for how default values are determined.

If a list-valued option is specified with a single value, that is not in parentheses, the single value is *added* to the current default list. For example, if the system configuration file contains the line

```
OUTPUT=(CODE,SPECIFICATION)
```

there is no user configuration file that has an OUTPUT= option, and the command line contains the option

```
... OUTPUT=LIST
```

then "LIST" is appended to the default list, so the value of OUTPUT is (CODE,SPECIFICATION,LIST).

Note: If NONE is a member of the OUTPUT list, then nothing would be generated, regardless of other entries in the list.

## Default Values

Most of the options have default values. Three things determine the default value:

- values built into the SQL\*Module compiler
- values set in the *system configuration file*
- values set in a *user configuration file*

For example, the option MAXLITERAL specifies the maximum length of strings generated by SQL\*Module. The built-in SQL\*Module default value for this option is 255 bytes. However, if MAXLITERAL=512 is specified in the system configuration file, the default now becomes 512. The user configuration file could set it to yet another value, which then overrides the system configuration value. Finally, if this option is set on the command line, that value will take precedence over the SQL\*Module default, the system configuration file specification, and the user configuration file specification. See "Configuration Files" below for more information about these files.

Some options, such as USERID, do not have a built-in default value. The built-in default values for options that have them are listed in the section "[Command-Line Options](#)" on page 5-8.

## Configuration Files

A configuration file is a text file that contains SQL\*Module options. Each record or line in the file contains one option, with its associated value or list of values. For example, a configuration file might contain the lines

```
BINDING=LATE
USERID=MODTEST
```

to set defaults for the BINDING and USERID options.

Note: You cannot put comments in a configuration file; there is no character or character combination that lets you comment out a line.

There is one system-wide configuration file associated with each system. The system configuration file is usually maintained by the project or group leader, or the database administrator. The location of this file is system specific. For more information, see your project leader, or your system-specific Oracle documentation.

If there is no system configuration file, the compiler prints a warning message, but compilation continues normally.

In addition, each SQL\*Module user can have one or more user (or local) configuration files. To activate the user configuration file, its name and path must be specified using the CONFIG= command-line option. See "[Command-Line Options](#)" on page 5-8. The user configuration file is optional.

The CONFIG= option never specifies the system configuration file. The location of the system configuration file is built into the SQL\*Module compiler, and can vary from system to system.

## Input Files

A SQL\*Module input file is a text file containing Module Language statements. You specify the input filename using the INAME= command-line option.

Input files have default file *extensions*, also referred to as *filetypes* in some operating systems. However, not all operating systems support file extensions. If your system does not support file extensions, the last few characters of the filename might serve as the extension. Refer to your operating system documentation and to your system-specific Oracle documentation for more information about filenames and file extensions.

If you do not specify an extension for the module input file, and your operating system uses file extensions, the compiler assumes a default extension, *.mad*.

## Output Files

SQL\*Module can generate four types of output files:

- a source code file
- a specification (or header) file
- a listing file



- a PL/SQL source file for a stored procedure or a package

Source code files contain generated code in the host language. *modada* generates Ada code. Specification or header files contain declarations for the procedures in the code files

## Source Code Output File

This file contains the host language code produced by the compiler. It is a source file in the host language, and you must compile it using your host language compiler to produce an object module. The object modules are in turn linked with the application's object modules and the SQL runtime library to form the executable program.

Note: Oracle recommends that you name output files explicitly, either in a configuration file or on the command line.

### Default File Names for Ada

If you do not specify an output code filename when you run *modada*, the output code filename defaults to a system-specific name. For example, on Sun workstations running the Solaris 1.0 Sun Ada compiler, the command

```
modada iname=my_test1.mad
```

generates an output code file named *my\_test1.a*. On other platforms, a different name might be generated. See your system-specific Oracle documentation for complete information.

## Specification File

By default, *modada* generates a specification or header file. The specification file contains declarations for the procedures in the generated output file.

### Default Specification Filenames for Ada

The default specification filename is the name of the input file, or the package name, followed by a system-dependent appendix, followed by a system-dependent file extension. For example, on a Sun workstation running Solaris 1.0, the command

```
modada iname=my_test1.mad
```

generates a default specification output file with the name *my\_test1s.a*. This is the value of *iname* minus the extension, with "s" appended.

On other platforms, the filename appendix and the filename extension might be different. See your system-specific Oracle documentation for complete information.

See [Chapter 6, "Demonstration Programs"](#) for language-dependent information about the content of specification files.

## Listing File

If `OUTPUT=LIST`, `SQL*Module` produces a listing of the Module Language source code, with errors, if any, flagged. Error codes and messages are interspersed in the list file, at the point where the `SQL*Module` parser first detected the error. The line length in the listing file defaults to 255 characters. If no end-of-line character is received before 255 characters are received, a system-specific end-of-line character or character sequence is output.

## PL/SQL Source Files

When you are generating interface procedure files from a stored package or procedure, and you specify the option `OUTPUT=PACKAGE, SQL*Module` generates PL/SQL source code output files. If the output is from a package, two files are generated. One file has the default file extension `.pks`, and contains the package specification code. The second file has the default extension `.pkb`, and contains the package body code. See the *PL/SQL User's Guide and Reference* for more information on package specifications and package bodies.

## Avoid Default Output Filenames

Use the `ONAME` and `SNAME` options to generate non-default output filenames. They are described below.

Oracle strongly recommends that you use these options, rather than letting the output filenames be generated by default.

## Command-Line Options

When an option is entered on the command line, its value overrides SQL\*Module defaults, any values specified in a configuration file, or values specified in a module file (for example, the `AUTHORIZATION` clause). The order of precedence is

- command-line options
- statements in the module file preamble
- user configuration file options
- system configuration file options
- default options built into the compiler

The format of a command-line option is:

```
OPTION_NAME=VALUE
```

There should be no whitespace around the equals sign. For example:

```
modada INAME=my_app3_mod ONAME=my_app3_mod SNAME=my_app3_pkg
```

compiles the input file `my_app3_mod.mad` to produce an output file named `my_app3_mod.a`, and a specification file named `my_app3_mod_pkgs.a`.

Note: The actual filename extensions are system specific. See your system-specific Oracle documentation for more information.

If the option can take a list of values and more than one value is being supplied, a comma-separated list of values is placed inside parentheses. For example:

```
OUTPUT=(CODE,SPECIFICATION)
```

There should be no whitespace anywhere in the list.

The names as well as arguments of the command-line options can be abbreviated. Instead of

```
OUTPUT=SPECIFICATION
```

you could enter

```
OUT=SPEC
```

or even

OU=SP

since neither "OU", "SPEC", nor "SP" is ambiguous. Filenames and package names cannot be abbreviated.

The command-line options, together with their default values, are listed in [Table 5–2](#), and are described in the remainder of this chapter.

**Table 5–2 The Command-line options**

Option Name	Option Purpose	Values
AUTO_CONNECT	Connect on first SQL statement if not already connected	YES   NO
BINDING	Early or late binding?	EARLY   LATE
CONFIG	Name of a user configuration file	<filename>
ERRORS	Destination of error messages	YES   NO
FIPS	Turns on FIPS flagger	YES   NO
INAME	Name of input file	<filename>
LNAME	Name of listing file	<filename>
LTYPE	Kind of listing file	NONE   SHORT   LONG
MAPPING	Resolves overloaded procedure names for the default WITH INTERFACE PROCEDURE clause	()   OVERLOAD
MAXLITERAL	Maximum length of string literal in generated host language code	10..1024
ONAME	Name of source code output file	<filename>
OUTPUT	Kinds of output files generated	One of, or list of two or more of (NONE   CODE   SPECIFICATION   LIST   PACKAGE
PNAME	Name of package in the database	<package_name>
RPC_GENERATE	Generate stubs from stored package or procedure?	YES   NO
SELECT_ERROR	Should a query returning more than one row generate a runtime error?	YES   NO
SNAME	Name of specification output file	<filename>
SQLCHECK	Kind of compile-time checking done	NONE   SYNTAX   SEMANTICS

**Table 5–2 (Cont.) The Command-line options**

Option Name	Option Purpose	Values
STORE_PACKAGE	Store module as a package in the database	YES   NO
USERID	Username and password	<string>

## AUTO\_CONNECT

### Values

{YES | NO}

### Default Value

NO

### Meaning

If AUTO\_CONNECT=YES, and you are not already connected to a database, when SQLLIB processes the first executable SQL statement, it attempts to connect using the userid

```
OPS$<username>
```

where username is your current operating system user or task name and OPS\$username is a valid Oracle userid.

When AUTO\_CONNECT=NO, you must use the CONNECT statement to connect to Oracle.

Can be entered only on the command line or in a configuration file.

## BINDING

### Values

{EARLY | LATE}

### Default Value

EARLY

### Meaning

The BINDING option is used when generating interface procedure files, that is, when RPC\_GENERATE=YES. Early binding means that a time stamp is derived from the time of compilation of the stored procedure, and the time stamp is saved in the interface procedures file.

When a stored procedure is called through a stub (specified in the interface procedures file), if the current time stamp on the procedure in the database is later than that specified in the stub, the message "time stamp of <stored procedure name> has been changed" (ORA-04062) is returned.

The stored package must have WITH INTERFACE clauses specified for each procedure when RPC\_GENERATE=YES, regardless of whether you choose early or late binding using the BINDING option. See the section "[Early and Late Binding](#)" on page 3-5 for more information.

## CONFIG

### Values

<filename>

### Default Value

None.

### Meaning

Specifies the name of a user configuration file that contains options. The user configuration file is a text file. Each option in the file must be on a separate line (record).

## ERRORS

### Values

{YES | NO}

### Default Value

YES

### Meaning

Specifies the destination for error message output. If ERRORS=YES, the output is both to the terminal and to the listing (*.lis*) file. If ERRORS=NO, error messages are sent only to the listing file.

## FIPS

### Values

{YES | NO}

### Default Value

NO

### Meaning

Specifies whether instances of non-compliance with the ANSI/ISO SQL standards will be flagged at compile time. If FIPS=YES, Oracle extensions to standard Module Language and standard SQL, as well as use of standard constructs in ways that violate the SQL standard format or syntax rules, are flagged by the FIPS flagger.

## INAME

### Values

<filename>

### Default Value

None.

### Meaning

Specifies the name of the input file. If the specified filename does not contain an extension, the compiler supplies the default extension for the host language. Only one input file is allowed. If more than one INAME option is specified, the last one prevails, and the earlier ones are ignored.

If STORE\_PACKAGE=NO and the PNAME option is specified, the INAME option cannot be specified. In this case, there is no input file, since the input comes from the stored package. If INAME is specified under these circumstances, SQL\*Module generates a warning message and continues, if possible.

## LNAME

### Values

<filename>

### Default Value

The base name of the listing file first defaults to the base name of INAME or, if INAME is not specified, it defaults to the name of the package specified in the PNAME option. The default file extension is *.lis*.

### Meaning

Specifies the name of the listing file. This option is valid only if the LTYPE option is *not* NONE.

## LTYPE

### Values

{NONE | SHORT | LONG}

### Default Value

LONG

### Meaning

Specifies the listing type. The OUTPUT option list must contain the VALUE LIST, otherwise this option has no effect.

If the LTYPE value is NONE, no list file is generated, regardless of the setting of the OUTPUT option. If the LTYPE value is SHORT, the list file contains no code, only error messages. LTYPE=LONG generates a complete listing file, with errors and code.

Note: When INAME is specified, the listing file shows Module Language code, not the generated host language code. When compiling an interface procedure, the listing

output contains only error messages, regardless of the LTYPE specification. See the OUTPUT option for more information on how to generate PL/SQL output source.

## MAPPING

### Values

() | OVERLOAD

where () indicates an empty string.

### Default Value

Empty string.

### Meaning

The MAPPING option is used when generating prototypes for the default WITH INTERFACE PROCEDURE clause. See "[The Default WITH INTERFACE Clause](#)" on page 3-12 for more information.

When MAPPING=OVERLOAD, SQL\*Module resolves overloaded stored procedure and function names when generating stubs. It does this by prefixing *MOD**n*\_ to the second and subsequent procedure names, where *n* starts with 2, and increments by 1 until all stubs for all overloaded procedures of that name have been resolved.

## MAXLITERAL

### Values

Numeric literal, range 10 to 1024 bytes

### Default Value

255 bytes

### Meaning

Specifies the maximum length of string literals generated by the SQL\*Module compiler, so that host language compiler limits are not exceeded. For example, if your system's compiler cannot handle string literals longer than 512 bytes, specify MAXLITERAL=512 in the system configuration file.

## ONAME

### Values

<filename>

### Default Value

The base name of the output file first defaults to the base name of INAME. If INAME is not specified, then ONAME defaults to the name of the package specified in the PNAME option, if present. The default file extension is system dependent, but is generally .a. The default output directory is the current directory.

**Meaning**

Specifies the name of the code output file. Whether an output file is actually generated depends on the values of the OUTPUT option. The OUTPUT list must contain the value CODE.

**OUTPUT****Values**

Any one or more of CODE, LIST, NONE, PACKAGE, SPECIFICATION

**Default Values**

CODE, SPECIFICATION

**Meaning**

Specifies what output files SQL\*Module generates. The values are

**CODE** An interface procedures file is generated.

**LIST** A listing file is generated. See the LNAME and LTYPE options for more information.

**NONE** No files are generated. This option is used to do syntactic and semantic checking of the input file, as error output is always generated.

**PACKAGE** PL/SQL source files are generated. These files contain the PL/SQL package generated by SQL\*Module. The default base filename is the same as the name specified in either the INAME or the PNAME option. If both are specified, the default is taken from INAME.

The default extensions are *.pks* (package specification) and *.pkb* (package body).

**SPECIFICATION** A specification file containing procedure declarations is generated. The filename extension is language specific. See "[Output Files](#)" on page 5-2 for more information.

*Note:* If the value NONE is included in the list, then no output of any kind is generated, regardless of any other values that might be in the list.

**PNAME****Values**

Name of a stored package or a stand-alone stored procedure in the Oracle database, or the name to be given to a stored package to be created in the database when STORE\_PACKAGE=YES.

**Default Value**

**For Output (when RPC\_GENERATE=YES)** There is no default value. You must specify the name of a package in the database. However, you can specify a complete pathname, including an extension, to serve as a default for ONAME. In this case, the directory hierarchy and the filename extension are ignored, and the basename is taken as the package name for database lookup.



**For Input (when STORE\_PACKAGE=YES)** The default value is the module name in the MODULE clause of the input file. If there is no module name, the default is taken from the INAME value.

**Meaning**

Specifies the name of the package stored in the database (if STORE\_PACKAGE=NO), or the name of a package to be created by SQL\*Module (if STORE\_PACKAGE=YES). The name must be a valid database object name.

## RPC\_GENERATE

**Values**

{YES | NO}

**Default Value**

NO

**Meaning**

Specifies whether SQL\*Module should produce an interface procedures file so that a host program can call stored procedures. You can use this option with STORE\_PACKAGE=NO and PNAME=<package\_name> to generate interface procedures for stand-alone or packaged procedures that are already stored in the database. You can also use this option with INAME=<filename> and STORE\_PACKAGE=YES to store procedures in a module file in the database, *and* generate an interface procedures file to access them.

## SELECT\_ERROR

**Values**

{YES | NO}

**Default Value**

YES

**Meaning**

Specifies whether an error is generated at runtime when a SELECT or FETCH statement returns more than one row.

## SNAME

**Values**

<filename>

**Default Value**

The base name of the input file, if specified, plus the appropriate extension for a specification file for the host language. For Ada, a system-specific filename addition and extension is used, such as *ora\_dcl* for VAX/OPEN VMS Ada, or *\*s.a* for Verdex Ada.

**Meaning**

Specifies the name of the specification or header file. If INAME is not specified, SNAME must be specified to get a specification file. The file is not generated if the OUTPUT option does not include SPECIFICATION in its list of values.

**STORE\_PACKAGE****Values**

{YES | NO}

**Default Value**

NO

**Meaning**

If STORE\_PACKAGE=YES, SQL\*Module compiles the module file specified in the mandatory INAME option, and stores the packaged procedures in the database schema specified by the USERID option. The name of the package is specified by the PNAME option.

If you do not specify a PNAME option, the default package name becomes the name of the module, as specified in the MODULE clause of the module file. If neither the PNAME option nor the MODULE clause is specified, the package name is the base name (omitting any path specification or file extension) of the input file specified in the INAME option.

Note: When STORE\_PACKAGE=YES, SQL\*Module performs a CREATE OR REPLACE PACKAGE statement. This statement overwrites, without any warning any package of that name in the schema.

**SQLCHECK****Values**

{NONE | SYNTAX | SEMANTICS}

Default Value

SEMANTICS

**Meaning**

Determines the way SQL\*Module processes the input file when INAME is specified. This option has no meaning if there is no input file.

**NONE** SQL\*Module processes the command line, issues any error messages produced by configuration file or command-line options, then exits without compiling any input and does not produce any output files.

**SYNTAX** SQL\*Module compiles the input file specified in the INAME option, using its own SQL parser. Errors detected are flagged, but no source code, specification, or listing output files are produced.

**SEMANTICS** The input file is compiled on the server side, all syntactic and semantic errors are flagged, and all appropriate output files are generated.

## USERID

### Values

<string>

Default Value

None

### Meaning

Specifies an Oracle username and, optionally, a password and a database to connect to. The syntax of this option is

```
USERID=USER_NAME[/PASSWORD][@DATABASE_NAME]
```

SQL\*Module must be able to connect to a server when compiling an input file, to parse the SQL and PL/SQL statements, do syntactic and semantic checking, and to store packages if required. If the password is omitted, SQL\*Module prompts for one. If a database is not specified, the default (local) database for the user is used.

If you do not specify the USERID option, the default becomes the user name (and possibly the password) specified in the AUTHORIZATION clause of the Module Language input file, or the USERID value specified in a configuration file.

Note: SQL\*Module always prompts for a password if one has not been supplied in a configuration file, in an AUTHORIZATION clause in the module file, or on the command line. So, there is no need to hard code passwords into text files.

## Compiling and Linking

To produce an executable program, you must compile source code output files that SQL\*Module generates, then link these together with the compiled object files of any sources that call modules or interface procedures, with SQLLIB, and with other Oracle libraries. The details are necessarily both system and language dependent. The tables in the next three sections show a few examples.

### An Example (Module Language)

There is a Module Language file to be compiled. No stored database packages are involved. The steps to take are shown in [Table 5-3](#).

Note: This example is specific to VAX/OPEN VMS. For other Ada implementations, using a linker for all Ada files might be required.

**Table 5–3 Development Scenario**

Step	File Name	How Developed	Action to Take
1	tst_app_drv.ada	by Ada developer	compile into Ada library using host Ada compiler
2	tst_app_mod.mad	by SQL developer	compile using SQL*Module
3	tst_app_mod.ora_dd	generated by SQL*module in Step 2	compile into Ada library using host Ada compiler
4	tst_app_mod.ada	generated by module from Step 2	compile into Ada library using host Ada compiler; make sure to with this package in <i>tst_app_drv.ada</i>
5	tst_app_drv.o	extracted from Adalib	link (with SQLLIB)
6	tst_app_drv	linked from step 5	run and test

---

---

## Demonstration Programs

This chapter provides information about using SQL\*Module host applications written in Ada. This chapter also includes sample programs that demonstrate how you can use SQL\*Module with an Ada application.

Topics covered are:

- [The SQL\\_STANDARD Package](#)
- [Sample Applications](#)

### The SQL\_STANDARD Package

You must use the datatypes defined in the supplied SQL\_STANDARD package. The SQL\_STANDARD package defines the packages, Ada bindings to the SQL datatypes, and the subtypes that are used for SQL\*Module with Ada. You must compile the supplied SQL\_STANDARD package into your Ada library, and with this package in each program unit that calls procedures generated from Module Language source, or that calls interface procedures.

The SQL\_STANDARD package is system specific. See your system-specific Oracle documentation for the location of this file on your system.

### SQLCODE

The standard type of the SQLCODE parameter for Ada is SQL\_STANDARD.SQLCODE\_TYPE.

### SQLSTATE

The standard type of the SQLSTATE parameter for Ada is SQL\_STANDARD.SQLSTATE\_TYPE. It is a five-character string.

### Sample Programs

The Module Language sample programs are based on an example database for a small college. This section demonstrates the tables that are used in the application, and a module that contains cursors and procedures that query and update the tables.

The database contains tables that maintain records about

- students
- courses
- classes (instances of courses)

- enrollment in classes
- instructors
- departments

The SQL statements below are used to create the tables used in the demonstration application. You can create the sample database, and fill it with some preliminary data, by using SQL\*Plus or SQL\*DBA to execute these scripts.

These scripts, and all other sample code files, are shipped with SQL\*Module. They are in the demo directory on your system.

## Sample Tables

The tables and sequence number generators are created by the MKTABLES.SQL script. At the end of this script, five other scripts are called to partially populate the tables. These five scripts are listed following MKTABLES.SQL.

### MKTABLES.SQL

```
REM Create all tables for the sample college database application.
```

```
REM Drop existing tables
```

```
REM Remove REMs next 6 lines when running under SQL*Plus
```

```
REM CLEAR SCREEN
```

```
REM Prompt WARNING!! About to recreate the SQL*Module example tables.
```

```
REM Prompt All previously entered data will be lost.
```

```
REM Prompt If you really want to do this, type ENTER or Return.
```

```
REM Prompt Else, type your CANCEL (INTR) character to exit
```

```
REM Pause this script now.
```

```
REM Prompt Dropping tables...
```

```
DROP TABLE students CASCADE CONSTRAINTS;
```

```
DROP TABLE instructors CASCADE CONSTRAINTS;
```

```
DROP TABLE courses CASCADE CONSTRAINTS;
```

```
DROP TABLE classes CASCADE CONSTRAINTS;
```

```
DROP TABLE enrollment CASCADE CONSTRAINTS;
```

```
DROP TABLE departments CASCADE CONSTRAINTS;
```

```
DROP SEQUENCE student_id_seq;
```

```
DROP SEQUENCE instructor_id_seq;
```

```
DROP SEQUENCE class_number_seq;
```

```
DROP SEQUENCE enrollment_seq;
```

```
CREATE SEQUENCE student_id_seq START WITH 1000;
```

```
CREATE SEQUENCE instructor_id_seq START WITH 100000;
```

```
CREATE SEQUENCE class_number_seq START WITH 100;
```

```
CREATE SEQUENCE enrollment_seq START WITH 100;
```

```
REM Prompt Creating tables...
```

```
CREATE TABLE departments (name          VARCHAR2(16) NOT NULL,  
                           id            NUMBER(6) PRIMARY KEY,  
                           location       NUMBER(4),  
                           chairperson   NUMBER(6),  
                           budget        NUMBER(9,2)  
                           );
```

```
CREATE TABLE instructors (last_name     VARCHAR2(15) NOT NULL,
```

```

first_name    VARCHAR2(15) NOT NULL,
mi            VARCHAR2(3),
id            NUMBER(6) PRIMARY KEY,
hire_date     DATE,
dept          NUMBER(6)
NOT NULL REFERENCES departments(id),
salary        NUMBER(9,2),
rank          VARCHAR2(20)
);

CREATE TABLE students (last_name    VARCHAR2(15) NOT NULL,
first_name    VARCHAR2(15) NOT NULL,
mi            VARCHAR2(3),
id            NUMBER(6) PRIMARY KEY,
status        VARCHAR2(5) NOT NULL,
date_of_birth DATE,
matric_date   DATE,
grad_date     DATE,
major         NUMBER(6)
REFERENCES departments(id),
advisor_id    NUMBER(6)
REFERENCES instructors(id)
);

CREATE TABLE courses (dept          NUMBER(6)
NOT NULL REFERENCES departments(id),
id            NUMBER(6),
name          VARCHAR2(38) NOT NULL
);

CREATE TABLE classes (class_number NUMBER(6) PRIMARY KEY,
course_number NUMBER(6) NOT NULL,
dept          NUMBER(6) NOT NULL,
max_enrollment NUMBER(4) NOT NULL,
building_number NUMBER(4),
room_number   NUMBER(5),
instructor    NUMBER(6),
quarter       NUMBER(1),
year          NUMBER(4)
);

CREATE TABLE enrollment (e_sn        NUMBER(6) PRIMARY KEY,
class_no      NUMBER(6) NOT NULL,
student_id    NUMBER(6) NOT NULL,
grade         NUMBER(3,2),
comments      VARCHAR2(255)
);

```

REM Prompt INSERTing sample data in tables...

```

@@departmt.sql
@@instrucs.sql
@@students.sql
@@courses.sql
@@enrolmnt.sql

```

## DEPARTMT.SQL

```
DELETE FROM departments;
```

```
INSERT INTO departments VALUES ('BIOLOGY', 100, 2510, null,100000);
INSERT INTO departments VALUES ('CHEMISTRY', 110, 2510, null, 50000);
INSERT INTO departments VALUES ('COMPUTER SCIENCE', 120, 2530, null, 110000);
INSERT INTO departments VALUES ('ELECTRIC. ENG.', 130, 2530, null, 145000);
INSERT INTO departments VALUES ('FINE ARTS', 140, 2520, null, 10000);
INSERT INTO departments VALUES ('HISTORY', 150, 2520, null, 20000);
INSERT INTO departments VALUES ('MATHEMATICS', 160, 2580, null, 5000);
INSERT INTO departments VALUES ('MECH. ENG.', 170, 2520, null, 100000);
INSERT INTO departments VALUES ('PHYSICS', 180, 2560, null, 300000);
```

### **INSTRUCS.SQL**

```
DELETE FROM instructors;

REM Add some faculty to the college

INSERT INTO instructors VALUES ('Webster', 'Milo', 'B', 9000,
    '01-SEP-49', 140, 40000, 'PROFESSOR');

INSERT INTO instructors VALUES ('Crown', 'Edgar', 'G', 9001,
    '03-SEP-70', 150, 35000, 'PROFESSOR');

INSERT INTO instructors VALUES ('Golightly', 'Claire', 'M', 9002,
    '24-AUG-82', 120, 33000, 'ASSISTANT PROFESSOR');

INSERT INTO instructors VALUES ('Winterby', 'Hugh', '', 9003,
    '10-SEP-82', 120, 43000, 'PROFESSOR');

INSERT INTO instructors VALUES ('Whipplethorpe', 'Francis', 'X',
    9004, '01-SEP-78', 170, 50000, 'PROFESSOR');

INSERT INTO instructors VALUES ('Shillingsworth', 'Susan', 'G',
    9005, '22-AUG-87', 160, 65000, 'PROFESSOR');

INSERT INTO instructors VALUES ('Herringbone', 'Leo', 'R', 9006,
    '02-JAN-81', 110, 40000, 'ASSOCIATE PROFESSOR');

INSERT INTO instructors VALUES ('Willowbough', 'George', 'T',
    9007, '04-SEP-86', 180, 37000, 'ASSOCIATE PROFESSOR');

INSERT INTO instructors VALUES ('Higham', 'Earnest', 'V', 9008,
    '10-JUN-76', 100, 55000, 'PROFESSOR');
```

### **STUDENTS.SQL**

```
DELETE FROM students;

INSERT INTO students VALUES ('Brahms', 'Susan', 'F',
    student_id_seq.nextval, 'FT', '10-JUN-75', sysdate, null, null, null);

INSERT INTO students VALUES ('Hiroki', 'Minoru', '',
    student_id_seq.nextval, 'FT', '12-AUG-71', sysdate, null, null, null);
```



```

INSERT INTO students VALUES ('Hillyard', 'James', 'T',
    student_id_seq.nextval, 'FT', '11-SEP-74', sysdate, null, null, null);

INSERT INTO students VALUES ('Kaplan', 'David', 'J',
    student_id_seq.nextval, 'FT', '02-MAR-74', sysdate, null, null, null);

INSERT INTO students VALUES ('Jones', 'Roland', 'M',
    student_id_seq.nextval, 'FT', '23-JAN-75', sysdate, null, null, null);

INSERT INTO students VALUES ('Rubin', 'Naomi', 'R',
    student_id_seq.nextval, 'PT', '23-FEB-54', sysdate, null, null, null);

INSERT INTO students VALUES ('Gryphon', 'Melissa', 'E',
    student_id_seq.nextval, 'FT', '08-JUL-75', sysdate, null, null, null);

INSERT INTO students VALUES ('Chen', 'Michael', 'T',
    student_id_seq.nextval, 'FT', '22-OCT-72', sysdate, null, null, null);

```

## COURSES.SQL

```

DELETE FROM courses;

REM Add a few courses for demo purposes

-- HISTORY
INSERT INTO courses VALUES (150, 101,
    'INTRODUCTION TO VENUSIAN CIVILIZATION');

INSERT INTO courses VALUES (150, 236,
    'EARLY MEDIEVAL HISTORIOGRAPHY');

INSERT INTO courses VALUES (150, 237,
    'MIDDLE MEDIEVAL HISTORIOGRAPHY');

INSERT INTO courses VALUES (150, 238,
    'LATE MEDIEVAL HISTORIOGRAPHY');

-- MATHEMATICS
INSERT INTO courses VALUES (160, 101, 'ANALYSIS I');

INSERT INTO courses VALUES (160, 102, 'ANALYSIS II');

INSERT INTO courses VALUES (160, 523, 'ADVANCED NUMBER THEORY');

INSERT INTO courses VALUES (160, 352, 'TOPOLOGY I');

-- COMPUTER SCIENCE
INSERT INTO courses VALUES (120, 210, 'COMPUTER NETWORKS I');

INSERT INTO courses VALUES (120, 182, 'OBJECT-ORIENTED DESIGN');

INSERT INTO courses VALUES (120, 141, 'INTRODUCTION TO Ada');

INSERT INTO courses VALUES (120, 140, 'ADVANCED 7090 ASSEMBLER');

```

## EMROLMNT.SQL

```

REM Create some classes and enroll some students in
REM them, to test the procedures that access
REM the ENROLLMENT table.

```

```
DELETE FROM classes;

REM Department 150 is HISTORY

INSERT INTO classes VALUES (900, 101, 150, 300, 2520, 100, 9001, 1, 1990);

INSERT INTO classes VALUES (901, 236, 150, 20, 2520, 111, 9001, 3, 1990);

INSERT INTO classes VALUES (902, 237, 150, 15, 2520, 111, 9001, 4, 1990);

INSERT INTO classes VALUES (903, 238, 150, 10, 2520, 111, 9001, 1, 1991);

REM Department 120 is COMPUTER SCIENCE
INSERT INTO classes VALUES (910, 210, 120, 60, 2530, 34, 9003, 1, 1990);

INSERT INTO classes VALUES (911, 182, 120, 120, 2530, 440, 9003, 1, 1991);

INSERT INTO classes VALUES (912, 141, 120, 60, 2530, 334, 9003, 2, 1990);

INSERT INTO classes VALUES (913, 140, 120, 300, 2530, 112, 9003, 1, 1989);

REM Now enroll Susan and Michael in some courses.

DELETE FROM enrollment
      WHERE student_id =
      (SELECT id FROM students
        WHERE first_name = 'Susan'
         AND last_name = 'Brahms');

DELETE FROM enrollment
      WHERE student_id =
      (SELECT id FROM students
        WHERE first_name = 'Michael'
         AND last_name = 'Chen');

INSERT INTO enrollment VALUES (enrollment_seq.nextval,
                               900, 1000, 3.0, 'Good');

INSERT INTO enrollment VALUES (enrollment_seq.nextval,
                               901, 1000, 3.5, 'Very Good');

INSERT INTO enrollment VALUES (enrollment_seq.nextval,
                               902, 1000, 4.0, 'Excellent');

INSERT INTO enrollment VALUES (enrollment_seq.nextval,
                               903, 1000, 2.0, 'Fair');

INSERT INTO enrollment VALUES (enrollment_seq.nextval,
                               910, 1007, 3.0, ' ');

INSERT INTO enrollment VALUES (enrollment_seq.nextval,
                               911, 1007, 3.0, ' ');

INSERT INTO enrollment VALUES (enrollment_seq.nextval,
                               912, 1007, 4.0, ' ');

INSERT INTO enrollment VALUES (enrollment_seq.nextval,
                               913, 1007, 2.0, ' ');
```

## Module Language Sample Program

```

-- SQL*Module demonstration module.
-- Contains procedures to maintain the college database.

-- PREAMBLE

MODULE          demomod
LANGUAGE        Ada
AUTHORIZATION   modtest

-----
----- STUDENTS TABLE-----
-----

-- The following cursors and procedures access the STUDENTS table
-- or the STUDENT_ID_SEQ sequence number generator.

-- Declare a cursor to select all students
-- in the college.

DECLARE GET_STUDENTS_CURS CURSOR FOR

        SELECT last_name, first_name, mi, id, status,
               major, advisor_id
        FROM students

-- Define procedures to open and close this cursor.

PROCEDURE open_get_students_curs (
        SQLCODE);

        OPEN GET_STUDENTS_CURS;

PROCEDURE close_get_students_curs (
        SQLCODE);

        CLOSE GET_STUDENTS_CURS;

-- Define a procedure to fetch using the
-- get_students_curs cursor.

PROCEDURE get_all_students (
        :lname          CHAR(15),
        :fname          CHAR(15),
        :mi             CHAR(3),
        :mi_ind         SMALLINT,
        :id             INTEGER,
        :status         CHAR(5),
        :major          INTEGER,
        :major_ind      SMALLINT,          -- indicator for major
        :adv            INTEGER,
        :adv_ind        SMALLINT,        -- indicator for advisor
        SQLCODE);

        FETCH get_students_curs
        INTO :lname, :fname, :mi INDICATOR :mi_ind,
            :id, :status, :major INDICATOR :major_ind,
            :adv INDICATOR :adv_ind;

-- Add a new student
-- to the database. Some of the columns in the

```

```
-- table are entered as null in this procedure.
-- The UPDATE_STUDENT procedure is used to fill
-- them in later.

PROCEDURE add_student (
    :last_name    CHARACTER(15),
    :first_name   CHARACTER(15),
    :mi           CHARACTER(3),
    :mi_ind       SMALLINT,
    :sid          INTEGER,
    :status       CHARACTER(5),
    :date_of_birth CHARACTER(9),
    :dob_ind      SMALLINT,
    SQLCODE);

    INSERT INTO students VALUES (
        :last_name,
        :first_name,
        :mi :mi_ind,
        :sid,
        :status,
        :date_of_birth :dob_ind,
        sysdate,                -- use today's date
                                -- for start date
        null,                    -- no graduation date yet
        null,                    -- no declared major yet
        null                     -- no advisor yet
    );

-- Update a student's record to add or change
-- status, major subject, advisor, and graduation date.

PROCEDURE update_student (
    :sid          INTEGER,        -- student's id number
    :major        INTEGER,       -- dept number of major
    :major_ind    SMALLINT,      -- indicator for major
    :advisor      INTEGER,       -- advisor's ID number
    :advisor_ind  SMALLINT,
    :grd_date     CHARACTER(9),
    :grad_date_ind SMALLINT,
    SQLCODE);

    UPDATE students SET
        grad_date = :grd_date INDICATOR :grad_date_ind,
        major = :major INDICATOR :major_ind,
        advisor_id = :advisor INDICATOR :advisor_ind
    WHERE id = :sid;

PROCEDURE delete_student (
    :sid          INTEGER,
    SQLCODE);

    DELETE FROM students
        WHERE id = :sid;

-- Get an ID number for a new student
-- using the student_id sequence generator. This
-- is done so that the ID number can be returned
-- to the add_student routine that calls
-- ENROLL.
```

```
PROCEDURE get_new_student_id (
    :new_id      INTEGER,
    SQLCODE);

    SELECT student_id_seq.nextval
    INTO :new_id
    FROM dual;

-- Return the name
-- of a student, given the ID number.

PROCEDURE get_student_name_from_id (
    :sid        INTEGER,
    :lname      CHAR(15),
    :fname      CHAR(15),
    :mi         CHAR(3),
    SQLCODE);

    SELECT last_name, first_name, mi
    INTO :lname, :fname, :mi
    FROM students
    WHERE id = :sid;

-----
----- INSTRUCTORS TABLE -----
-----

-- Define a procedure to return an instructor's last
-- name, given the ID number.

PROCEDURE get_instructor_name_from_id (
    :iid        INTEGER,
    :lname      CHAR(15),
    :fname      CHAR(15),
    :imi        CHAR(3),
    :mi_ind     SMALLINT,
    SQLCODE);

    SELECT last_name, first_name, mi
    INTO :lname, :fname, :imi INDICATOR :mi_ind
    FROM instructors
    WHERE id = :iid;

-----
----- DEPARTMENTS TABLE -----
-----

-- Define procedure to return the name of a department
-- given its ID number.

PROCEDURE get_department_name_from_id (
    :did        INTEGER,
    :dept_name  CHARACTER(16),
    SQLCODE);

    SELECT name
    INTO :dept_name
    FROM departments
    WHERE id = :did;
```

```
-----
----- COURSES TABLE -----
-----

-- (none defined yet)

-----
----- CLASSES TABLE -----
-----

-- Add a class to the classes table.

PROCEDURE add_class (
    :class_no      INTEGER,
    :dept_no       INTEGER,
    :course_no     INTEGER,
    :max_students  INTEGER,
    :instr_id      INTEGER,
    :quarter       INTEGER,
    :year          INTEGER,
    SQLCODE);

    INSERT INTO classes VALUES (
        :class_no,
        :course_no,
        :dept_no,
        :max_students,
        null,                -- building number and
        null,                -- room not yet assigned
        :instr_id,
        :quarter,
        :year
    );

-- Drop a class.

PROCEDURE delete_class (
    :class_no      INTEGER,
    SQLCODE);

    DELETE FROM classes
        WHERE class_number = :class_no;

-- Get an ID number for a new class.
-- A class is an instance of a course.
-- Use the class_number_seq sequence generator.

PROCEDURE get_new_class_id (
    :new_id        INTEGER,
    SQLCODE);

    SELECT class_number_seq.nextval
        INTO :new_id
        FROM dual;

-----
----- ENROLLMENT TABLE -----
-----

-- Declare a cursor to return information about all
```

```
-- classes a given student has or is enrolled in his
-- or her college career.

-- In this college, letter grades are assigned
-- numbers, in the following format:
-- A 4.0
-- B+ 3.5
-- B 3.0
-- C+ 2.5
-- C 2.0
-- D 1.0
-- F 0.0

DECLARE get_enroll_curs CURSOR FOR

    SELECT courses.name,
           classes.instructor,
           classes.year,
           classes.quarter,
           enrollment.grade,
           enrollment.comments
    FROM courses, classes, enrollment
    WHERE courses.id = classes.course_number
           AND classes.class_number = enrollment.class_no
           AND enrollment.student_id = :sid

-- Define a procedure to open the GET_ENROLL_CURS cursor.
-- Note that this procedure requires an IN parameter to set
-- the student ID number (sid).

PROCEDURE open_get_enroll_curs (
    :sid      INTEGER,
    SQLCODE);

    OPEN GET_ENROLL_CURS;

-- CLOSE the get_enroll_curs cursor

PROCEDURE close_get_enroll_curs (
    SQLCODE);

    CLOSE get_enroll_curs;

-- FETCH from the courses, classes, and enrollment table
-- using the get_enroll_curs cursor

PROCEDURE get_enroll_by_student (
    :course_name  CHARACTER(38),
    :instructor   INTEGER,
    :year         INTEGER,
    :quarter      INTEGER,
    :grade        REAL,
    :grade_ind    SMALLINT,
    :comments     CHARACTER(255),
    SQLCODE);

    FETCH get_enroll_curs
    INTO :course_name,
        :instructor,
        :year,
```

```

        :quarter,
        :grade INDICATOR :grade_ind,
        :comments;

-- Enroll a student in a class.

PROCEDURE enroll_student_in_class (
    :class_number INTEGER,
    :sid           INTEGER,
    SQLCODE);

    INSERT INTO enrollment VALUES (
        enrollment_seq.nextval,
        :class_number,
        :sid,
        null,                    -- no grade yet
        ' '                      -- no comments yet
    );

-----
----- UTILITY PROCEDURES -----
-----

-- Commit a transaction.

PROCEDURE do_commit(
    SQLCODE);

    COMMIT WORK;

-- Connect to a database

PROCEDURE do_connect (
    :dbname     CHARACTER(14),
    :username   CHARACTER(14),
    :passwd     CHARACTER(14),
    SQLCODE);

    CONNECT TO :dbname USER :username USING :passwd;

-- Disconnect

PROCEDURE do_disconnect (
    SQLCODE);

    DISCONNECT CURRENT;

-- Roll a transaction back.

PROCEDURE do_rollback (
    SQLCODE);

    ROLLBACK WORK;

```

## Calling a Stored Procedure

The sample stored package defined below can be used to demonstrate how to call a stored procedure from an Ada application. The package source is GPAPKG.SQL, and it is in your demo directory. See the program "DEMCALSP.A" on page 6-28, written in



the host language, that calls the GET\_GPA\_IF procedure in this package. Each of these host programs is also on-line, in your demo directory.

```
-- Create the specification for a package
-- that contains the GET_GPA stored procedure.
-- Use the WITH INTERFACE clause so that
-- the package procedure can be called from a 3GL.

-- Note that the procedure parameters have PL/SQL
-- datatypes, but in the WITH INTERFACE clause
-- SQL datatypes must be used, and they must be
-- constrained if required (for example, CHARACTER(15)).
-- The WITH INTERFACE clause allows you to
-- specify error-handling parameters, such as SQLSTATE,
-- as well as indicator parameters. These are filled
-- in as the procedure executes.

-- The calling host 3GL application calls the procedure
-- named in the WITH INTERFACE clause. This
-- would usually be given the same name as the procedure
-- in the body. Here it is given a different name, to
-- demonstrate that (1) you can do this, and (2) it is
-- the WITH INTERFACE clause name that gets
-- generated in the interface procedure as the procedure to call.

-- Note that this package will create
-- the package and procedure names in uppercase. So the
-- module compiler will generate interface procedures that have
-- the names
-- in uppercase, which means that you must call them using
-- upper case in your host program. If you prefer lowercase,
-- simply change the package and procedure names to be
-- quoted lowercase, for example:
--
-- CREATE OR REPLACE PACKAGE "gpa_pkg" AS ...

CREATE OR REPLACE PACKAGE GPA_PKG AS

    PROCEDURE GET_GPA(student_id      IN      NUMBER,
                     student_last_name IN OUT CHARACTER,
                     gpa              OUT    NUMBER)

    WITH INTERFACE
    PROCEDURE GET_GPA_IF
        (student_id      INTEGER,
         student_last_name CHARACTER(15)
         INDICATOR sname_ind,
         sname_ind      SMALLINT,
         gpa             REAL,
         sqlstate       CHARACTER(5),
         sqlcode         INTEGER);

END;

-- Create the package body. There is no need for
-- a WITH INTERFACE clause in the body.
-- The GET_GPA procedure computes the cumulative GPA
-- over all courses that the student has taken, and returns
-- the computed value. If the student has received no
-- grades yet, a null is returned (through the indicator
-- parameter).
```

```
CREATE OR REPLACE PACKAGE BODY GPA_PKG AS

    PROCEDURE GET_GPA(student_id      IN      NUMBER,
                     student_last_name IN OUT CHARACTER,
                     gpa              OUT    NUMBER) IS

-- The cursor selects all the classes that
-- the student has enrolled in.

    CURSOR get_enroll_curs(sid IN NUMBER) IS
        SELECT enrollment.grade
        FROM   enrollment
        WHERE  enrollment.student_id = sid
              AND enrollment.grade IS NOT NULL;

-- Declare local variables.
-- gpa_temp needed because gpa is an OUT parameter
    n      NUMBER := 0;
    grade  NUMBER;
    gpa_temp NUMBER := 0;

    BEGIN
        gpa := 0.0;

-- Get the last name;
-- if not found, the no_data_found
-- predefined exception is raised.
        SELECT last_name
        INTO student_last_name
        FROM students
        WHERE id = student_id;

-- Otherwise, open the cursor and FETCH.
        open get_enroll_curs(student_id);
        loop
            FETCH get_enroll_curs INTO grade;
            exit when get_enroll_curs%notfound;
            gpa_temp := gpa_temp + grade;
            n := n + 1;
        end loop;

        close get_enroll_curs;

        if n > 0 then
            gpa := gpa_temp / n;
        end if;

    exception

-- The SQLCODE parameter in the WITH INTERFACE
-- parameter list will not be set to +100 because
-- the exception is handled here, but the indicator
-- variable will be set to -1 because of the null
-- assignment.
        when no_data_found then
            student_last_name := null;
        end GET_GPA;

END;
```

## Sample Applications

This section contains sample applications that may aid development.

### DEMOHOST.A

```
-- Module Language demonstration program for Ada.
-- For an explanation of the tables that are accessed
-- and the Module Language procedures that
-- are called in this program, see Sample Programs.
--
-- The module language code that contains the procedures called
-- by this program, and SQL scripts to create and populate
-- the tables used, are included in the source distribution.
--

with
-- The required SQL standard package.
  sql_standard,

-- The module language procedures package.
  demomod,

-- Other I/O packages...
  text_io,
  float_text_io,
  integer_text_io;

use
-- use the standard I/O packages.
  text_io,
  sql_standard,
  float_text_io,
  integer_text_io;

procedure DEMOHOST is

-- instantiate new packages for I/O on SQL_STANDARD datatypes
  package STD_INT_IO is
    new text_io.integer_io(SQL_STANDARD.INT);
  use STD_INT_IO;

  package SQLCODE_IO is
    new text_io.integer_io(SQL_STANDARD.SQLCODE_TYPE);
  use SQLCODE_IO;

  package STD_SMALLINT_IO is
    new text_io.integer_io(SQL_STANDARD.SMALLINT);
  use STD_SMALLINT_IO;

  package STD_FLOAT_IO is
    new text_io.float_io(SQL_STANDARD.REAL);
  use STD_FLOAT_IO;

-- declare main procedure variables and exceptions

-- handle command input
  type COMMAND is
```

```
(AC, AS, DC, DS, ES, SE, SS, US, HELP, QUIT, BYE);

package COMMAND_IO is
    new text_io.enumeration_io(COMMAND);
use COMMAND_IO;

COM_LINE      : COMMAND;

-- make SQLCODE global since program structure allows this
SQLCODE       : SQL_STANDARD.SQLCODE_TYPE;
ANSWER        : string(1..4);
LENGTH        : integer;
SERVICE_NAME : SQL_STANDARD.CHAR(1..14);
USERNAME      : SQL_STANDARD.CHAR(1..14);
PASSWORD      : SQL_STANDARD.CHAR(1..14);

-- declare top-level exceptions
CONNECT_ERROR : exception;
SQLCODE_ERROR : exception;

-- define procedures

-- get a user command
procedure GET_COMMAND(CMD : out COMMAND) is
begin
    loop
    begin
        new_line(2);
        put("Select an option: ");
        get(CMD);
        return;
    exception
        when data_error =>
            put_line
                (ascii.bel & "Invalid option, try again.");
    end;
    end loop;
end GET_COMMAND;

procedure MENU is
begin
    new_line(5);
    put_line("          *** COLLEGE RECORDS ***");
    new_line;
    put_line("AC - add a class to curriculum");
    put_line("AS - enroll a new student in the college");
    put_line("DC - drop a class from curriculum");
    put_line("DS - drop a student");
    put_line("ES - enroll a student in a class");
    put_line("SE - show complete enrollment records");
    put_line("SS - show all students");
    put_line("US - update a student's record");
    put_line("HELP - redisplay this menu");
    put_line("QUIT - quit program");
    new_line(3);
end MENU;
```

```

-- Procedure to get an integer value from the user,
-- prompting first.
procedure GET_STANDARD_INT(PROMPT : string;
                           VALUE  : out SQL_STANDARD.INT) is

begin
    put(prompt);
    get(integer(VALUE));
    skip_line;
end GET_STANDARD_INT;

-- Get a text string from the user, prompting first.
-- The string is blank-padded.
procedure GET_STANDARD_TEXT(PROMPT : in    string;
                             VALUE  : out  SQL_STANDARD.CHAR;
                             LENGTH : in out integer) is

    OLD_LENGTH : integer;

begin
    OLD_LENGTH := LENGTH;
    put(PROMPT);
    VALUE := (1..LENGTH => ' ');
    get_line(string(VALUE), LENGTH);

    if LENGTH = OLD_LENGTH then
        skip_line;
    end if;

end GET_STANDARD_TEXT;

-- The following procedures, all beginning with the prefix
-- "CALL_", are called from the main procedure,
-- and in turn call Module Language procedures, defined
-- in the DEMOMOD.mad file.

procedure CALL_ADD_CLASS is

    CLASS_NUMBER      : SQL_STANDARD.INT;
    DEPARTMENT_NUMBER : SQL_STANDARD.INT;
    COURSE_NUMBER     : SQL_STANDARD.INT;
    MAX_ENROLLMENT    : SQL_STANDARD.INT;
    INSTRUCTOR_ID     : SQL_STANDARD.INT range
                       1000..SQL_STANDARD.INT'last;
    QUARTER            : SQL_STANDARD.INT range 1..4;
    YEAR               : SQL_STANDARD.INT range 1900..2100;

begin
    new_line(2);
    put_line("Add a new class to the schedule");
    new_line(2);

    DEMOMOD.GET_NEW_CLASS_ID(CLASS_NUMBER, SQLCODE);

    if SQLCODE /= 0 then
        put("Cannot generate new class number. CODE is ");
        put(SQLCODE);
        new_line;
    end if;
end CALL_ADD_CLASS;

```

```

        put_line(" Call your database administrator.");
        return;
    else
        put("New class number is ");
        put(CLASS_NUMBER);
        new_line;
    end if;

loop
begin
    new_line;
    GET_STANDARD_INT
        ("Enter dept ID: ", DEPARTMENT_NUMBER);

    GET_STANDARD_INT
        ("Enter course ID number: ", COURSE_NUMBER);
    GET_STANDARD_INT
        ("maximum enrollment: ", MAX_ENROLLMENT);
    GET_STANDARD_INT
        ("instructor ID number: ", INSTRUCTOR_ID);
    GET_STANDARD_INT
        ("quarter (1=spring, 2=summer, ...: ", QUARTER);
    GET_STANDARD_INT("year (4 digits please): ", YEAR);

    DEMOMOD.ADD_CLASS(CLASS_NUMBER, COURSE_NUMBER,
                      DEPARTMENT_NUMBER, MAX_ENROLLMENT,
                      INSTRUCTOR_ID,
                      QUARTER, YEAR, SQLCODE);

    if SQLCODE /= 0 then
        put("Error adding class. CODE is ");
        put(SQLCODE);
        new_line;
    else
        put_line("New class added.");
    end if;
    exit;
exception
    when CONSTRAINT_ERROR =>
        new_line;
        put_line("Last input not valid. Try again.");
        new_line;

end;
end loop;
end CALL_ADD_CLASS;

procedure CALL_ADD_STUDENT is
    ERROR_COUNT : integer := 0;
    SIZE         : integer;
    NEW_ID       : SQL_STANDARD.INT;
    MI_IND       : SQL_STANDARD.SMALLINT;
    TEMP_STRING  : string(1..80);
    FIRST_NAME   : SQL_STANDARD.CHAR(1..15);
    LAST_NAME    : SQL_STANDARD.CHAR(1..15);
    MI           : SQL_STANDARD.CHAR(1..3);
    DATE_OF_BIRTH : SQL_STANDARD.CHAR(1..9);
    DOB_IND      : SQL_STANDARD.SMALLINT;
    STATUS       : SQL_STANDARD.CHAR(1..5);
    LENGTH       : integer;

```

```
begin
  new_line(2);
  put_line("Add a new student to the database.");
  new_line(2);

  DEMOMOD.GET_NEW_STUDENT_ID(NEW_ID, SQLCODE);
  if SQLCODE /= 0 then
    put_line("Cannot generate ID number for student.");
    put("CODE is ");
    put(SQLCODE);
    new_line;
    put_line("Call your database administrator.");
    return;
  end if;

  skip_line;
  loop
    begin
      new_line;
      LENGTH := 15;
      GET_STANDARD_TEXT("  Last name: ", LAST_NAME,
                        LENGTH);

      LENGTH := 15;
      GET_STANDARD_TEXT("  First name: ", FIRST_NAME,
                        LENGTH);

      LENGTH := 3;
      GET_STANDARD_TEXT("  Middle initial: ", MI,
                        LENGTH);

      if LENGTH = 0 then
        MI_IND := -1;
      else
        MI_IND := 0;
      end if;

      LENGTH := 9;
      GET_STANDARD_TEXT("  Date of birth (DD-MON-YY): ",
                        DATE_OF_BIRTH, LENGTH);

      if LENGTH = 0 then
        DOB_IND := -1;
      else
        DOB_IND := 0;
      end if;

      LENGTH := 5;
      GET_STANDARD_TEXT("  Status (FT, PT, JYA, ...): ",
                        STATUS, LENGTH);

      DEMOMOD.ADD_STUDENT(LAST_NAME,
                          FIRST_NAME,
                          MI, MI_IND,
                          NEW_ID,
                          STATUS,
                          DATE_OF_BIRTH,
                          DOB_IND,
                          SQLCODE);
    end loop;
end;
```

```
        if SQLCODE /= 0 then
            new_line;
            put("Error adding student. CODE is ");
            put(SQLCODE, width => 5);
        else
            new_line;
            put("Student added. ID number is");
            put(NEW_ID, width => 6);
        end if;
        new_line(3);
        return;
    exception
        when constraint_error =>
            ERROR_COUNT := ERROR_COUNT + 1;
            if ERROR_COUNT > 3 then
                put_line
                    ("Too many errors. Back to main program.");
                exit;
            end if;
            put_line("Invalid value. Try again.");
        when others =>
            put_line("Data error or other error.");
            exit;
    end;
end loop;
end CALL_ADD_STUDENT;

procedure CALL_DROP_CLASS is
    CLASS_NUMBER      : SQL_STANDARD.INT;

begin
    new_line(2);
    put_line("Drop a class");
    new_line(2);

    GET_STANDARD_INT
        (" Enter class ID number: ", CLASS_NUMBER);

    DEMOMOD.DELETE_CLASS(CLASS_NUMBER, SQLCODE);

    if SQLCODE /= 0 then
        new_line;
        put("Error dropping the class. CODE is ");
        put(SQLCODE);
        new_line;
        put_line("Call your database administrator.");
    else
        put_line("Class dropped.");
    end if;
end CALL_DROP_CLASS;

procedure CALL_DROP_STUDENT is
    LAST_NAME, FIRST_NAME : SQL_STANDARD.CHAR(1..15);
    MI                   : SQL_STANDARD.CHAR(1..3);
    STUDENT_ID           : SQL_STANDARD.INT;
    ANSWER               : string(1..12);
    ALEN                  : integer;
```



```

begin
  new_line(2);
  put_line("Drop a student from the college.");
  new_line(2);

  GET_STANDARD_INT
    (" Enter student ID number: ", STUDENT_ID);
  DEMOMOD.GET_STUDENT_NAME_FROM_ID(STUDENT_ID,
    LAST_NAME,
    FIRST_NAME, MI,
    SQLCODE);

  if SQLCODE /= 0 then
    new_line;
    put("Error getting student information. CODE is ");
    put(SQLCODE);
    new_line;
    put_line("Call your database administrator.");
    return;
  end if;

  put_line("Student's name is--");
  put_line(string(FIRST_NAME & MI & LAST_NAME));
  put("Do you really want to do this? ");
  get_line(ANSWER, ALEN);
  if ANSWER(1) = 'Y' or ANSWER(1) = 'y' then
    DEMOMOD.DELETE_STUDENT(STUDENT_ID, SQLCODE);
    if SQLCODE /= 0 then
      put_line("Error dropping student. CODE is ");
      put(SQLCODE);
      return;

    else
      put_line
        (string(LAST_NAME) & " has been dropped!");
    end if;
  else
    put_line("OK, student will not be dropped.");
  end if;

end CALL_DROP_STUDENT;

procedure CALL_ENROLL_STUDENT is
  CLASS_NUMBER, STUDENT_ID : SQL_STANDARD.INT;
  LAST_NAME, FIRST_NAME    : SQL_STANDARD.CHAR(1..15);
  MI                       : SQL_STANDARD.CHAR(1..3);

begin
  new_line(2);
  put_line("Enroll a student in a class.");
  new_line(2);

  GET_STANDARD_INT(" Enter student ID: ", STUDENT_ID);
  GET_STANDARD_INT(" Enter class ID: ", CLASS_NUMBER);
  DEMOMOD.GET_STUDENT_NAME_FROM_ID(STUDENT_ID,
    LAST_NAME,
    FIRST_NAME,
    MI,
    SQLCODE);

  if SQLCODE /= 0 then

```

```
        new_line;
        put_line("That student ID does not exist.");
        put("CODE is ");
        put(SQLCODE);
        new_line;
        put_line("Recheck and try again.");
    else
        put_line
            (" The student's name is " & string(LAST_NAME));
        put(" Enrolling...");
        DEMOMOD.ENROLL_STUDENT_IN_CLASS(CLASS_NUMBER,
                                        STUDENT_ID,
                                        SQLCODE);

        if SQLCODE /= 0 then
            new_line;
            put("Error occurred enrolling student. CODE is ");
            put(SQLCODE);
            new_line;
            put_line("Check class ID number and try again.");

        else
            put_line("done");
        end if;
    end if;
end CALL_ENROLL_STUDENT;

procedure CALL_SHOW_ENROLLMENT is
    COURSE_NAME      : SQL_STANDARD.CHAR(1..38);
    INSTR_ID, SID, YEAR, QUARTER : SQL_STANDARD.INT;
    GRADE, GPA       : SQL_STANDARD.REAL;
    GRADE_IND        : SQL_STANDARD.SMALLINT;
    COMMENTS         : SQL_STANDARD.CHAR(1..255);
    GRADE_COUNT, ROW_COUNT : integer;

begin
    new_line(2);
    put_line("Show enrollment in all courses for a student.");
    new_line(2);

    GET_STANDARD_INT
        (" Enter student ID number (try 1000): ", SID);

    DEMOMOD.OPEN_GET_ENROLL_CURS(SID, SQLCODE);
    if SQLCODE /= 0 then
        new_line;
        put("Error opening cursor. CODE is ");
        put(SQLCODE);
        new_line;
        put_line("Call your database administrator.");
    else
        GPA := 0.0;
        GRADE_COUNT := 0;
        ROW_COUNT := 0;

        put("COURSE TITLE                               ");
        put_line("INSTR ID   YEAR   QUARTER   GRADE");

        loop
            DEMOMOD.GET_ENROLL_BY_STUDENT(COURSE_NAME,
```

```

                                INSTR_ID,
                                YEAR, QUARTER,
                                GRADE, GRADE_IND,
                                COMMENTS,
                                SQLCODE);

    if SQLCODE = 100 then
        exit;
    elsif SQLCODE /= 0 then
        new_line;
        put_line("Error fetching data. CODE is ");
        put(SQLCODE);
        new_line;
        put_line("Call your database administrator.");
        exit;
    else
        ROW_COUNT := ROW_COUNT + 1;
        put(string(COURSE_NAME));
        put(INSTR_ID, width => 6);
        put(YEAR, width => 11);
        put(QUARTER, width => 6);
        if GRADE_IND >= 0 then
            GRADE_COUNT := GRADE_COUNT + 1;
            GPA := GPA + GRADE;
            put(GRADE, fore => 7, aft => 2, exp => 0);
        end if;
    end if;
    new_line;
end loop;

if GRADE_COUNT > 0 and SQLCODE = 100 then
    new_line;
    GPA := GPA / REAL(GRADE_COUNT);
    put("Overall GPA is ");
    put(GPA, fore => 1, aft => 2, exp => 0);
end if;

DEMOMOD.CLOSE_GET_ENROLL_CURS(SQLCODE);
if SQLCODE /= 0 then
    new_line;
    put("Error closing cursor. CODE is ");
    put(SQLCODE);
    new_line;
end if;
end if;

end CALL_SHOW_ENROLLMENT;

procedure CALL_SHOW_STUDENTS is
    LAST_NAME, FIRST_NAME      : SQL_STANDARD.CHAR(1..15);
    MI                          : SQL_STANDARD.CHAR(1..3);

    INSTR_LAST_NAME            : SQL_STANDARD.CHAR(1..15);
    INSTR_FIRST_NAME           : SQL_STANDARD.CHAR(1..15);
    INSTR_MI                   : SQL_STANDARD.CHAR(1..3);

    MI_IND, INSTR_MI_IND       : SQL_STANDARD.SMALLINT;
    SID, MAJOR, ADVISOR, INSTR : SQL_STANDARD.INT;
    MAJOR_IND, ADVISOR_IND     : SQL_STANDARD.SMALLINT;
    STATUS                      : SQL_STANDARD.CHAR(1..5);

```

```
begin
    new_line(2);
    put_line("  ----- STUDENTS CURRENTLY ENROLLED -----");
    new_line(2);

    put("LAST NAME      FIRST NAME      MI  ID NO  STATUS");
    put_line(" MAJOR  ADVISOR");
    DEMOMOD.OPEN_GET_STUDENTS_CURS(SQLCODE);
    if SQLCODE /= 0 then
        new_line;
        put("Error opening cursor. CODE is ");
        put(SQLCODE);
        new_line;
        put_line("Call your database administrator.");
        return;
    end if;

    loop
        DEMOMOD.GET_ALL_STUDENTS(LAST_NAME,
                                FIRST_NAME,
                                MI, MI_IND,
                                SID, STATUS,
                                MAJOR, MAJOR_IND,
                                ADVISOR, ADVISOR_IND,
                                SQLCODE);

        if SQLCODE = 100 then
            exit;
        elsif SQLCODE /= 0 then
            new_line;
            put_line("Error fetching data. CODE is ");
            put(SQLCODE);
            new_line;
            put_line("Call your database administrator.");
            exit;
        else
            put(string(LAST_NAME));
            put(string(FIRST_NAME));
            put(string(MI));
            put(SID, width => 5);
            put("  ");
            put(string(STATUS));
            put("  ");

            if MAJOR_IND < 0 then
                put("(NONE)");
            else
                put(MAJOR);
            end if;
            if ADVISOR_IND = 0 then
                DEMOMOD.GET_INSTRUCTOR_NAME_FROM_ID
                    (ADVISOR,
                     INSTR_LAST_NAME,
                     INSTR_FIRST_NAME,
                     INSTR_MI, INSTR_MI_IND,
                     SQLCODE);

                if SQLCODE = 0 then
                    put(" " & string(INSTR_LAST_NAME));
                else
                    put("[err = ");
                end if;
            end if;
        end loop;
    end;
```

```
                put(SQLCODE);
                put("]");
            end if;
        else
            put(" (NONE)");
        end if;
    end if;
    new_line;
end loop;

DEMOMOD.CLOSE_GET_STUDENTS_CURS(SQLCODE);
if SQLCODE /= 0 then
    new_line;
    put("Error closing cursor. CODE is ");
    put(SQLCODE);
    new_line;
    put_line("Call your database administrator.");
    new_line;
end if;

end CALL_SHOW_STUDENTS;

procedure CALL_UPDATE_RECORD is
    SID, ADVISOR, MAJOR      : SQL_STANDARD.INT;
    GRAD_DATE               : SQL_STANDARD.CHAR(1..9);
    ADVISOR_IND, MAJOR_IND  : SQL_STANDARD.SMALLINT;
    GRAD_DATE_IND           : SQL_STANDARD.SMALLINT;
    LENGTH                  : integer;
    LAST_NAME               : SQL_STANDARD.CHAR(1..20);
    FIRST_NAME              : SQL_STANDARD.CHAR(1..20);
    MI                      : SQL_STANDARD.CHAR(1..3);

begin
    new_line(2);
    put_line("Update a student's records.");
    new_line(2);

    GET_STANDARD_INT(" Enter student ID number: ", SID);
    DEMOMOD.GET_STUDENT_NAME_FROM_ID(SID,
                                     LAST_NAME,
                                     FIRST_NAME,
                                     MI,
                                     SQLCODE);

    if SQLCODE /= 0 then
        new_line;
        put_line("That student ID does not exist.");
        new_line;
        put_line("Recheck and try again.");
        return;
    else
        put_line
            (" The student's last name is " & string(LAST_NAME));
        new_line;
    end if;

    put(" Change major? If so, enter new department ");
    GET_STANDARD_INT("number. If not, enter 0: ", MAJOR);
```

```
        if MAJOR = 0 then
            MAJOR_IND := -1;
        else
            MAJOR_IND := 0;
        end if;

        put(" New advisor? If so, enter the instructor ID ");
        GET_STANDARD_INT("number. If not, enter 0: ", ADVISOR);

        if ADVISOR = 0 then
            ADVISOR_IND := -1;
        else
            ADVISOR_IND := 0;
        end if;

        put_line
(" Has the student graduated. If so, enter date (DD-MON-YY)");
        LENGTH := 9;
        GET_STANDARD_TEXT
        (" If not, press RETURN: ", GRAD_DATE, LENGTH);

        if LENGTH = 0 then
            GRAD_DATE_IND := -1;
        else
            GRAD_DATE_IND := 0;
        end if;

        DEMOMOD.UPDATE_STUDENT(SID,
                                MAJOR, MAJOR_IND,
                                ADVISOR, ADVISOR_IND,
                                GRAD_DATE, GRAD_DATE_IND,
                                SQLCODE);

        if SQLCODE /= 0 then
            new_line;
            put("Error updating records. Code is ");
            put(SQLCODE);
            new_line;
            put_line("Call your database administrator.");
        else
            new_line;
            put_line("Records updated. ");
        end if;

    end CALL_UPDATE_RECORD;

-----
----- main -----
-----

begin

    SQLCODE_IO.default_width := 6;

    SERVICE_NAME := "inst1_alias ";
    USERNAME     := "modtest     ";
    PASSWORD     := "yes        ";
    DEMOMOD.DO_CONNECT(SERVICE_NAME, USERNAME, PASSWORD, SQLCODE);
    if SQLCODE /= 0 then
        raise connect_error;
```

```
end if;
put_line("Connected to ORACLE.");
new_line;
MENU;

loop
  GET_COMMAND(COM_LINE);
  case COM_LINE is
    when AC => CALL_ADD_CLASS;
    when AS => CALL_ADD_STUDENT;
    when DC => CALL_DROP_CLASS;
    when DS => CALL_DROP_STUDENT;
    when ES => CALL_ENROLL_STUDENT;
    when SE => CALL_SHOW_ENROLLMENT;
    when SS => CALL_SHOW_STUDENTS;
    when US => CALL_UPDATE_RECORD;
    when HELP => MENU;
    when QUIT | BYE =>
      skip_line;
      new_line(5);
      put("Commit all changes [yn]: ");
      LENGTH := 4;
      get_line(ANSWER, LENGTH);
      if (ANSWER(1..1) = "y") then
        DEMOMOD.DO_COMMIT(SQLCODE);
        put_line("Changes committed.");
      else
        DEMO_MOD.DO_ROLLBACK;
        put_line("Changes discarded.");
      end if;
      new_line(2);
      put_line("G'Day!");
      new_line(4);
      exit;
    end case;
  end loop;
  DEMOMOD.DO_DISCONNECT(SQLCODE);
  if SQLCODE /= 0 then
    put("Error disconnecting. SQLCODE is ");
    put(SQLCODE);
    put_line("Exiting anyway.");
  end if;
exception
  when CONNECT_ERROR =>
    put_line("Error connecting to ORACLE.");
    new_line(4);
  when SQLCODE_ERROR =>
    put("Error fetching data. CODE is ");
    put(sqlcode);
    new_line(4);
    DEMOMOD.DO_DISCONNECT(SQLCODE);
  when others =>
    put_line("Unhandled error occurred. Fix the program!");
    new_line(4);

end DEMOHOST;
```

**DEMCALSP.A**

```

-- demcalsp.a
--
-- Sample program that demonstrates how to call a
-- database stored procedure using the WITH INTERFACE
-- PROCEDURE clause.
--
-- The stored package is in the file GPAPKG.SQL.

-- Include the required specs. Demomod must be included
-- since it contains the connect and disconnect procedures.

with TEXT_IO,
     SQL_STANDARD,
     GPA_PKG,
     DEMOMOD,
     FLOAT_TEXT_IO,
     INTEGER_TEXT_IO;

use TEXT_IO,
     SQL_STANDARD,
     FLOAT_TEXT_IO,
     INTEGER_TEXT_IO;

procedure DEMCALSP is

-- Define the required I/O packages for SQL_STANDARD.
package STD_INT_IO is
    new TEXT_IO.INTEGER_IO(SQL_STANDARD.INT);
use STD_INT_IO;

package SQLCODE_IO is
    new TEXT_IO.INTEGER_IO(SQL_STANDARD.SQLCODE_TYPE);
use SQLCODE_IO;

package STD_SMALLINT_IO is
    new TEXT_IO.INTEGER_IO(SQL_STANDARD.SMALLINT);
use STD_SMALLINT_IO;

package STD_FLOAT_IO is
    new TEXT_IO.FLOAT_IO(SQL_STANDARD.REAL);
use STD_FLOAT_IO;

STUDENT_ID      : SQL_STANDARD.INT;
STUDENT_LAST_NAME : SQL_STANDARD.CHAR(1..15);
NAME_IND        : SQL_STANDARD.SMALLINT;
GPA              : SQL_STANDARD.REAL;
PASSWORD        : SQL_STANDARD.CHAR(1..12);
SERVICE_NAME    : SQL_STANDARD.CHAR(1..12);
USERNAME        : SQL_STANDARD.CHAR(1..12);
SQLCODE         : SQL_STANDARD.SQLCODE_TYPE;
SQLSTATE        : SQL_STANDARD.SQLSTATE_TYPE;

CONNECT_ERROR    : exception;
SQLCODE_ERROR    : exception;

begin

    PASSWORD      := "yes          ";
    SERVICE_NAME  := "inst1_alias ";

```



```

        USERNAME      := "modtest      ";

        DEMOMOD.DO_CONNECT(SERVICE_NAME, USERNAME, PASSWORD, SQLCODE);
        if SQLCODE /= 0 then
            raise CONNECT_ERROR;
        end if;
        new_line(2);
        put_line("Get grade point average--");
        new_line;

        loop
        begin
            new_line;
            put("Enter student ID number (try 1000) (0 to quit): ");
            get(STUDENT_ID);
            new_line;
            exit when STUDENT_ID = 0;

-- Call the stored procedure.
            GPA_PKG.GET_GPA_IF(STUDENT_ID, STUDENT_LAST_NAME,
                               NAME_IND, GPA, SQLSTATE, SQLCODE);
            if SQLCODE /= 0 then
                raise SQLCODE_ERROR;
            end if;

            if NAME_IND = 0 then
                new_line;
                put("Last name is " & string(STUDENT_LAST_NAME));
                put("Overall GPA is");
                put(GPA, fore => 4, aft => 2, exp => 0);
            else
                put("There is no student with ID number");
                put(STUDENT_ID, width => 5);
                new_line;
            end if;
        exception
            when SQLCODE_ERROR =>
                new_line;
                put("Error fetching data, SQLCODE is ");
                put(SQLCODE, width => 5);
        end;
        end loop;

-- Disconnect from the server.
        DEMOMOD.DO_DISCONNECT(SQLCODE);
        if SQLCODE /= 0 then
            put("Error disconnecting. SQLCODE is ");
            put(SQLCODE);
            put_line("Exiting anyhow.");
        end if;

    exception
        when CONNECT_ERROR =>
            put("Error connecting to Oracle.");

end DEMCALSP;

```



---

---

## New Features

This appendix contains a list of the new features in release 8.0 of SQL\*Module for Ada.

### New Statements

- [CONNECT](#). (See "[CONNECT Statement](#)" on page 2-13.)
- [SET CONNECTION](#). (See "[SET CONNECTION Statement](#)" on page 2-14.)
- [DISCONNECT](#). (See "[DISCONNECT Statement](#)" on page 2-14.)
- [ENABLE THREADS](#). (See "[ENABLE THREADS](#)" on page 2-15.)
- [CONTEXT ALLOCATE](#). (See "[CONTEXT ALLOCATE](#)" on page 2-16.)
- [CONTEXT FREE](#). (See "[CONTEXT FREE](#)" on page 2-16.)

### Other New Features

- New datatype for multi-tasking, `SQL_CONTEXT`. (See "[SQL\\_CONTEXT Datatype](#)" on page 2-15.)
- Support for procedure declaration with arrays. (See "[Arrays as Procedure Arguments](#)" on page 4-7.)
- Function for obtaining the rows processed. (See "[Obtaining the Number of Rows Processed](#)" on page 4-4.)
- Function for obtaining error message text. (See "[Obtaining Error Message Text](#)" on page 4-2.)
- Dynamic SQL. (See "[Dynamic SQL](#)" on page 3-9.)



---



---

## Module Language Syntax

This appendix describes the syntax of Module Language, using syntax diagrams.

For the complete syntax of all SQL statements, including syntax diagrams, see *PL/SQL User's Guide and Reference*.

### Module Language Syntax Diagrams

Syntax diagrams use lines and arrows to show how procedure names, parameters, and other language elements are sequenced to form statements. Follow each diagram in the direction shown by the lines and arrows.

In these syntax diagrams, Module Language keywords appear in uppercase; parameters or other variable items appear in lowercase. Delimiters and terminators (such as '(', ',', and so on) appear in their literal form inside circles.

If the syntax diagram contains more than one possible path, you must select the path appropriate to your application.

If you have the choice of more than one keyword or parameter, your options appear in a vertical list. If any of the parameters in a vertical list appears on the main path, then one of them is required. That is, you must choose one of the parameters, but not necessarily the one that appears on the main path.

Single required parameters appear on the main path, that is, on the horizontal line you are currently traveling. If parameters appear in a vertical list below the main path, they are optional, that is, you need not choose one of them. In the `AUTHORIZATION` clause of the module preamble, the username is mandatory, but the password and database to connect to are optional, as shown in this diagram:

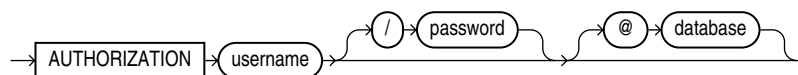

Loops let you repeat the syntax contained within them as many times as you like.

Here is the syntax diagram for a module:

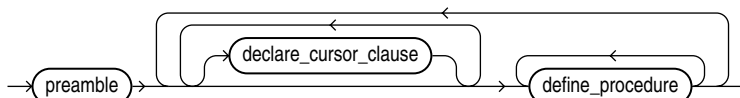

Thus, a module consists of a preamble, followed by zero or more cursor declarations, followed by one or more procedures.

## Preamble

The syntax of the preamble is:

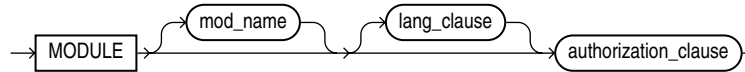

### LANGUAGE Clause

The following diagram shows the syntax of the optional language clause (lang\_clause) of the preamble:

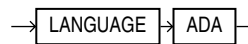

### AUTHORIZATION Clause

The following diagram shows the syntax of the AUTHORIZATION clause:

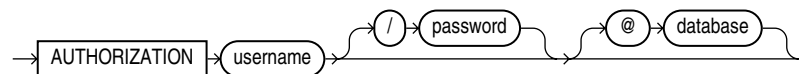

## Cursors

The syntax of the cursor declaration is:

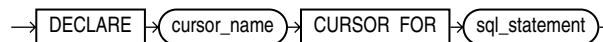

## Procedure Definitions

The SQL92 syntax for a procedure definition is:

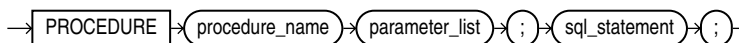

where the parameter list is defined as:

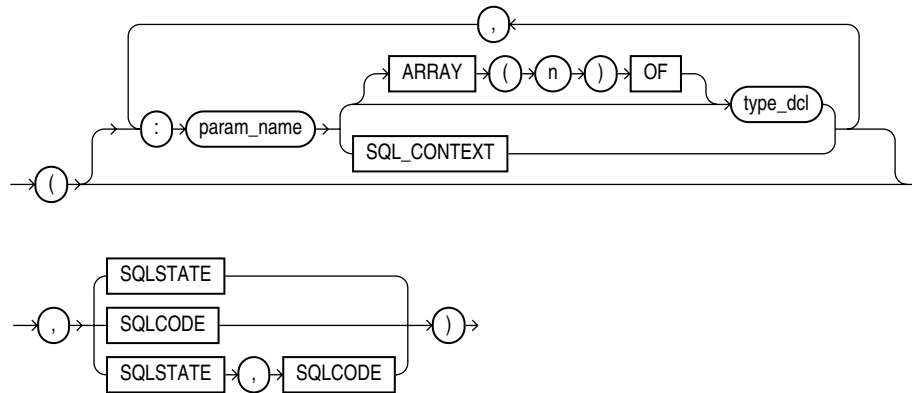

Where type\_dcl is defined as:

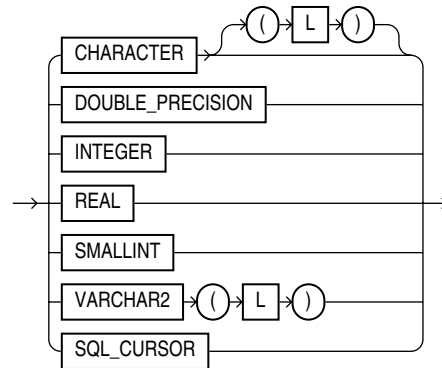

Length L has values:  $1 < L < 32500$ . n is the size of the array.

You can place the SQLSTATE and/or the SQLCODE status parameters anywhere in the parameter list; they are conventionally shown at the end of the parameter list in this Guide, as indicated in this syntax diagram. You must include either SQLSTATE (recommended) or SQLCODE (for backward compatibility with SQL89). You can include both, in any order. Do not place a colon before the status parameter, and do not include a datatype after it.

## WITH INTERFACE CLAUSE

The syntax of a procedure declaration that includes a WITH INTERFACE clause is formally defined as:

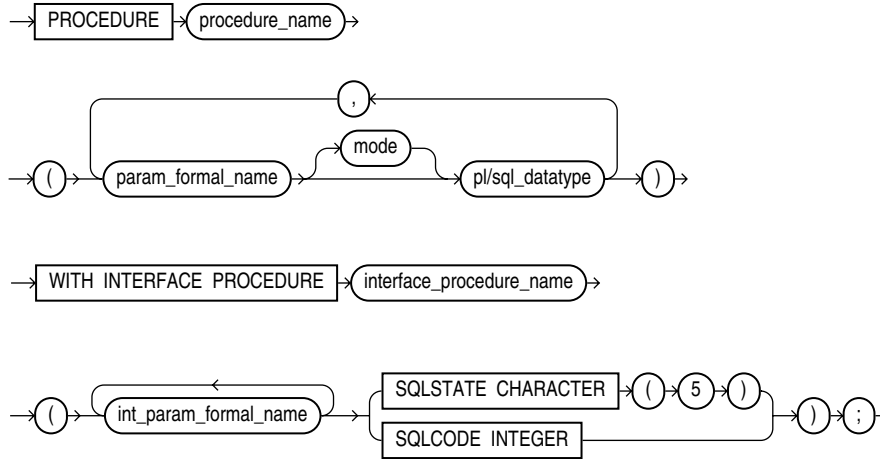

The `int_param_formal_name` is defined as:

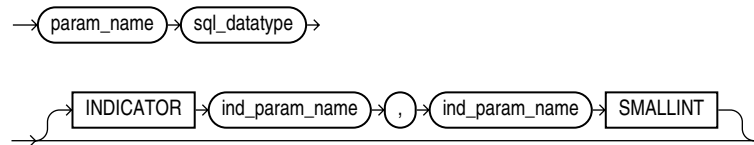

The SQL datatype in the `WITH INTERFACE` clause must be compatible with the corresponding PL/SQL datatype in the procedure declaration parameter list.

The syntax of the mode attribute is:

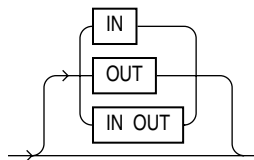

If mode is omitted, the value is `IN`.



---

---

## Reserved Words

The words listed in this appendix are reserved by Oracle or by SQL\*Module. For PL/SQL reserved words, see *PL/SQL User's Guide and Reference*.

### Module Reserved Words

The following words are reserved by Oracle and by SQL\*Module. You cannot use them to name a module, nor to name cursors, procedures, or procedure parameters in a module.

ADA, ARRAY, ALL, ALLOCATE, ALTER, AND, ANGLE\_BRK, ANSIC, ANY, AREASIZE, ARRAYLEN, AS, ASC, AT, AUDIT, AUTHORIZATION, AUTO, AVG, BEGIN, BETWEEN, BIND, BREAK, BY, C, CASE, CAT, CHAR, CHARACTER, CLOSE, COBOL, CODE, COMMENT, COMMIT, CONNECT, CONNECTION, CONTEXT, CONST, CONTINUE, CREATE, CURRENT, CURRVAL, CURSOR, DATABASE, DATE, DEC, DECI, DECIMAL, DECLARE, DEFAULT, DEFINE, DEFINED, DELETE, DESC, DESCRIBE, DESCRIPTOR, DISCONNECT, DISPLAY, DISTINCT, DO, DOUBLE, DROP, ELSE, ENABLE, END, ENDEXEC, ENDF, ENUM, ERRORS, ESCAPE, EXCLUSIVE, EXEC, EXECUTE, EXECORACLE, EXECORACLEELSE, EXECORACLEENDIF, EXECSQL, EXECSQLBEGIN, EXECSQLEND, EXECSQLTYPE, EXECSQLVAR, EXECUTE, EXISTS, EXTERN, FETCH, FIPS, FLOAT, FOR, FORCE, FORTRAN, FOUND, FREE, FROM, FULL, FUNCTION, GET, GO, GOTO, GRANT, GROUP, HAVING, HOLDCURSOR, IAF, IDENTIFIED, IF, IFDEF, IFNDEF, IMMEDIATE, IN, INCLUDE, INCSQL, INDICATOR, INSERT, INT, INTEGER, INTERSECT, INTO, IS, ISOLATION, KRC, LANGUAGE, LEVEL, LIKE, LIMITED, LIST, LOCK, LOCKLONG, MAX, MAXLITERAL, MAXOPENCURSORS, MIN, MINUS, MOD, MODE, MODULE, NEXTVAL, NO, NOAUDIT, NONE, NOT, NOTFOUND, NOWAIT, NULL, NUMBER, NUMERIC, OF, ONLY, OPEN, OPTION, OR, ORACA, ORACLE, ORACLE\_C, ORDER, PACKAGE, PASCAL, PLI, PRECISION, PREPARE, PRIOR, PROCEDURE, PUT, RAW, READ, REAL, REBIND, REENRANT, REFERENCE, REGISTER, RELEASE, RELEASE\_CURSOR, REM, RENAME, RETURN, REVOKE, ROLLBACK, ROW, ROWID, ROWNUM, SAVEPOINT, SECTION, SEGMENT, SELECT, SELECTERROR, SEMANTICS, SERIALIZABLE, SET, SHARE, SHORT, SIGNED, SIZEOF, SMALLINT, SOME, SQL, SQL2, SQL89, SQLCHECK, SQLCODE, SQLERRM, SQLERROR, SQLROWS, SQLSTATE, SQLWARNING, SQL\_CONTEXT, SQL\_CURSOR, START, STATEMENT, STATIC, STDDEV, STOP, STRING, STRUCT, SUM, SWITCH, SYNTAX, SYSDATE, TABLE, THREADS, TO, TRANSACTION, TYPEDEF, UID, UNDEF, UNION, UNIQUE, UNSIGNED, UPDATE, USE, USER, USING, VALIDATE, VALUES, VARCHAR, VARCHAR2, VARIABLES, VARIANCE, VARNUM, VARRAW, VARYING, VOID, VOLATILE, WHEN, WHENEVER, WHERE, WHILE, WITH, WORK, WORKWRITE, WRITE, XOR\_EQ, XOR\_WQ, YES



---



---

## SQLSTATE Codes

This appendix contains a table of the SQLSTATE codes and the conditions and errors associated with them.

### SQLSTATE Codes

Code	Condition	Oracle Error
00000	successful completion	ORA-00000
01000	warning	
01001	cursor operation conflict	
01002	disconnect error	
01003	null value eliminated in set function	
01004	string data - right truncation	
01005	insufficient item descriptor areas	
01006	privilege not revoked	
01007	privilege not granted	
01008	implicit zero-bit padding	
01009	search condition too long for info schema	
0100A	query expression too long for info schema	
02000	no data	ORA-01095 ORA-01403
07000	dynamic SQL error	
07001	using clause does not match parameter specs	
07002	using clause does not match target specs	
07003	cursor specification cannot be executed	
07004	using clause required for dynamic parameters	
07005	prepared statement not a cursor specification	
07006	restricted datatype attribute violation	
07007	using clause required for result fields	
07008	invalid descriptor count	SQL-02126

<b>Code</b>	<b>Condition</b>	<b>Oracle Error</b>
07009	invalid descriptor index	
08000	connection exception	
08001	SQL client unable to establish SQL connection	
08002	connection name in use	
08003	connection does not exist	SQL-02121
08004	SQL server rejected SQL connection	
08006	connection failure	
08007	transaction resolution unknown	
0A000	feature not supported	ORA-03000 .. 03099
0A001	multiple server transactions	
21000	cardinality violation	ORA-01427 SQL-02112
22000	data exception	
22001	string data - right truncation	ORA-01401 ORA-01406
22002	null value - no indicator parameter	ORA-01405 SQL-02124
22003	numeric value out of range	ORA-01426 ORA-01438 ORA-01455 ORA-01457
22005	error in assignment	
22007	invalid date-time format	
22008	date-time field overflow	ORA-01800 .. 01899
22009	invalid time zone displacement value	
22011	substring error	
22012	division by zero	ORA-01476
22015	interval field overflow	
22018	invalid character value for cast	
22019	invalid escape character	ORA-00911 ORA-01425
22021	character not in repertoire	
22022	indicator overflow	ORA-01411

<b>Code</b>	<b>Condition</b>	<b>Oracle Error</b>
22023	invalid parameter value	ORA-01025 ORA-01488 ORA-04000 .. 04019
22024	unterminated C string	ORA-01479 .. 01480
22025	invalid escape sequence	ORA-01424
22026	string data - length mismatch	
22027	trim error	
23000	integrity constraint violation	ORA-00001 ORA-02290 .. 02299
24000	invalid cursor state	ORA-01001 .. 01003 ORA-01410 ORA-08006 SQL-02114 SQL-02117 SQL-02118 SQL-02122
25000	invalid transaction state	
26000	invalid SQL statement name	
27000	triggered data change violation	
28000	invalid authorization specification	
2A000	direct SQL syntax error or access rule violation	
2B000	dependent privilege descriptors still exist	
2C000	invalid character set name	
2D000	invalid transaction termination	
2E000	invalid connection name	
33000	invalid SQL descriptor name	
34000	invalid cursor name	
35000	invalid condition number	
37000	dynamic SQL syntax error or access rule violation	
3C000	ambiguous cursor name	
3D000	invalid catalog name	
3F000	invalid schema name	

<b>Code</b>	<b>Condition</b>	<b>Oracle Error</b>
40000	transaction rollback	ORA-02091 .. 02092
40001	serialization failure	
40002	integrity constraint violation	
40003	statement completion unknown	
42000	syntax error or access rule violation	ORA-00022 ORA-00251 ORA-00900 .. 00999 ORA-01031 ORA-01490 .. 01493 ORA-01700 .. 01799 ORA-01900 .. 02099 ORA-02140 .. 02289 ORA-02420 .. 02424 ORA-02450 .. 02499 ORA-03276 .. 03299 ORA-04040 .. 04059 ORA-04070 .. 04099
44000	with check option violation	ORA-01402
60000	system errors	ORA-00370 .. 00429 ORA-00600 .. 00899 ORA-06430 .. 06449 ORA-07200 .. 07999 ORA-09700 .. 09999

<b>Code</b>	<b>Condition</b>	<b>Oracle Error</b>
61000	resource error	ORA-00018 .. 00035  ORA-00050 .. 00068  ORA-02376 .. 02399  ORA-04020 .. 04039
62000	multi-threaded server and detached process errors	ORA-00100 .. 00120  ORA-00440 .. 00569
63000	Oracle*XA and two-task interface errors	ORA-00150 .. 00159  SQL-02128  ORA-02700 .. 02899  ORA-03100 .. 03199  ORA-06200 .. 06249
64000	control file, database file, and redo file errors; archival and media recovery errors	ORA-00200 .. 00369  ORA-01100 .. 01250
65000	PL/SQL errors	ORA-06500 .. 06599
66000	SQL*Net driver errors	ORA-06000 .. 06149  ORA-06250 .. 06429  ORA-06600 .. 06999  ORA-12100 .. 12299  ORA-12500 .. 12599
67000	licensing errors	ORA-00430 .. 00439
69000	SQL*Connect errors	ORA-00570 .. 00599  ORA-07000 .. 07199

<b>Code</b>	<b>Condition</b>	<b>Oracle Error</b>
72000	SQL execute phase errors	ORA-01000 .. 01099  ORA-01400 .. 01489  ORA-01495 .. 01499  ORA-01500 .. 01699  ORA-02400 .. 02419  ORA-02425 .. 02449  ORA-04060 .. 04069  ORA-08000 .. 08190  ORA-12000 .. 12019  ORA-12300 .. 12499  ORA-12700 .. 21999
82100	out of memory (could not allocate)	SQL-02100
82101	inconsistent cursor cache: unit cursor/global cursor mismatch	SQL-02101
82102	inconsistent cursor cache: no global cursor entry	SQL-02102
82103	inconsistent cursor cache: out of range cursor cache reference	SQL-02103
82104	inconsistent host cache: no cursor cache available	SQL-02104
82105	inconsistent cursor cache: global cursor not found	SQL-02105
82106	inconsistent cursor cache: invalid Oracle cursor number	SQL-02106
82107	program too old for runtime library	SQL-02107
82108	invalid descriptor passed to runtime library	SQL-02108
82109	inconsistent host cache: host reference is out of range	SQL-02109
82110	inconsistent host cache: invalid host cache entry type	SQL-02110
82111	heap consistency error	SQL-02111
82112	unable to open message file	SQL-02113
82113	code generation internal consistency failed	SQL-02115
82114	reentrant code generator gave invalid context	SQL-02116
82115	invalid hstdef argument	SQL-02119



---

<b>Code</b>	<b>Condition</b>	<b>Oracle Error</b>
82116	first and second arguments to sqlrcn both null	SQL-02120
82117	invalid OPEN or PREPARE for this connection	SQL-02122
82118	application context not found	SQL-02123
82119	connect error; can't get error text	SQL-02125
82120	precompiler/SQLLIB version mismatch.	SQL-02127
82121	FETCHed number of bytes is odd	SQL-02129
82122	EXEC TOOLS interface is not available	SQL-02130
90000	debug events	ORA-10000 .. 10999
99999	catch all	all others
HZ000	remote database access	



---

---

## System-Specific References

This appendix contains a complete list of the features of the SQL\*Module compiler and its libraries that are system specific.

### System-Specific Aspects of SQL\*Module

This section describes the system-specific aspects of the SQL\*Module compiler features and their libraries that are system specific.

#### Supported Compilers

The Ada compiler that you can use to compile the code generated by SQL\*Module is platform specific. See your system-dependent documentation.

#### Character Case in Command Lines

Operating systems differ in case sensitivity. See ["Case of Package and Procedure Names"](#) on page 3-4 for more information.

#### Location of Files

The location in the directory hierarchy of the SQL\*Module executable, the system configuration file, and the SQLLIB and OCILIB libraries can differ from system to system. See ["Invoking SQL\\*Module"](#) on page 5-3 and ["Configuration Files"](#) on page 5-6.

#### Filename Extensions

The default filename extensions that SQL\*Module generates for output files might vary from platform to platform. See ["Output Files"](#) on page 5-6.

#### Ada Output Files

The default filenames and filename extensions for Ada depend on the supported compiler for your system. See ["Source Code Output File"](#) on page 5-7 and ["Listing File"](#) on page 5-7.

#### Command Line

The command line interpreter makes assumptions about defaults that are system specific. See your system-specific Oracle documentation.

## **Ada SQL\_STANDARD Package**

The SQL\_STANDARD package that is shipped with the Ada version of SQL\*Module can differ from system to system, depending on the requirements of your Ada compiler. See your system-specific Oracle documentation.

## Symbols

---

@ operator  
in SQL\*Plus, 3-3

## A

---

Ada  
example code, 6-15  
named parameter association, 2-9  
positional parameter association, 2-9  
Ada example for VAX/VMS, 5-17  
anonymous blocks, 3-2  
anonymous blocks in PL/SQL, 3-6  
Application Programming Interfaces (APIs), 5-9  
Arrays as Procedure Arguments, 4-7  
AUTHORIZATION clause, 2-6  
AUTO\_CONNECT  
command-line option, 5-10

## B

---

BINDING  
command-line option, 5-10  
binding  
early, 1-6, 3-5  
late, 1-6, 3-5  
BINDING command-line option, 3-6

## C

---

case sensitivity in program names, option names, and values, 5-4  
case-sensitive characters  
in names of executables, 5-4  
in package and procedure names, 3-4  
code page, 4-8  
command-line option value lists, 5-5  
command-line options  
about, 5-8  
case-sensitive characters in, 3-5  
CONFIG, 5-6  
specifying an option, 5-4  
whitespace used in, 5-8  
Comments, 2-11  
comments  
C-style, 2-11

not allowed in a configuration file, 5-6  
SQL-style, 2-11  
compiling and linking  
about, 5-17  
CONFIG  
command-line option, 5-11  
CONFIG command-line option, 5-6  
configuration files  
system, 5-5, 5-6  
user, 5-5, 5-6  
CONNECT statement, 2-13  
connecting to a database  
AUTHORIZATION clause and, 2-7  
calling RPC stubs and, 3-15  
CONTEXT ALLOCATE statement, 2-16  
CONTEXT FREE statement, 2-16  
conventions  
for text in a module file, 2-11  
COURSES.SQL script, 6-5  
CREATE PROCEDURE command, 3-2  
cursor  
concept of, 4-1  
declaring, 2-1  
name of, 2-7  
namespace for, 2-8  
syntax of, B-2  
using in queries, 4-6  
cursor declarations, 2-7  
cursor variable  
closing, 3-9  
cursor variable parameters, 3-7  
cursor variables, 2-7, 3-7, 4-6  
allocating, 3-7  
must use late binding, 3-8  
not available for Ada, 3-7  
opening, 3-7  
opening in a standalone stored procedure, 3-8  
return types, 3-9  
cursor variables, restrictions on, 3-9

## D

---

database concepts for host application  
developer, 4-1  
datatypes  
conversion, 1-3

SQL, 2-9  
declaring a cursor, 2-1  
demo directory, 0-xiii  
DEPARTMT.SQL script, 6-3  
DISCONNECT statement, 2-14  
Dynamic SQL, 3-9

## E

---

early binding, 1-6, 3-5  
EMROLMNT.SQL script, 6-5  
ENABLE THREADS statement, 2-15  
encoding scheme, 4-8  
error messages, 2-13  
    handling of, 1-2, 4-2  
ERRORS  
    command-line option, 5-11

## F

---

filename extension default values, 5-6  
files  
    input, 5-6  
    output, 5-6  
filetype, 5-6  
FIPS  
    command-line option, 5-11  
    flagger, 0-xii

## I

---

INAME  
    command-line option, 5-12  
indicator parameters, 2-11, 3-10  
    definition of, 4-5  
    truncation indicated by, 2-12  
    values greater than zero, 4-6  
indicator variables, 4-5  
    concept of, 4-1  
    used to show nulls, 2-12  
input files, 5-6  
INSTRUCS.SQL script, 6-4  
interface procedures  
    definition of, 1-6  
    files, 1-6  
    stubs, 1-6

## L

---

LANGUAGE clause, 2-6  
late binding, 1-6, 3-5  
linking, 5-17  
listing file output from SQL\*Module, 5-7  
listing options and default values, 5-4  
LNAME  
    command-line option, 5-12  
LTYPE  
    command-line option, 5-12

## M

---

makefile, 5-3  
MAPPING  
    command-line option, 5-13  
MAXLITERAL  
    command-line option, 5-13  
MKTABLES.SQL script, 6-2  
mode of a parameter in PL/SQL, 3-2  
module  
    cursor declarations in, 2-1  
    definition of, 2-1  
    preamble to, 2-1  
    procedures in, 2-1  
    structure of, 2-6  
MODULE clause, 2-6  
module file  
    text conventions in, 2-11  
Module Language  
    defined by ANSI committee, 1-3  
    sample program, 2-1, 6-1  
    syntax diagrams for, B-1  
Module Language Sample Program, 6-7  
Multi-tasking, 2-15  
Multi-tasking Example, 2-16  
Multi-tasking Restrictions, 2-16

## N

---

named parameter association, 2-9  
NLS parameter  
    NLS\_LANG, 4-8  
null value  
    concept of, 4-1  
    handling, 4-4  
    indicator variable shows null, 2-12  
Number of Rows Processed, obtaining, 4-4

## O

---

ONAME  
    command-line option, 5-13  
OPEN command  
    not used for cursor variables, 2-11  
opening a cursor variable, 3-7  
operating system command line, 5-3  
options on command line, 5-4  
Oracle Call Interface (OCI)  
    anonymous PL/SQL blocks and, 3-6  
OUTPUT  
    command-line option, 5-14  
output file default name for Ada, 5-7  
output files  
    for SQL\*Module, 5-6

## P

---

packages, 3-3  
parameter list, 2-8  
password  
    in AUTHORIZATION clause, 2-6

- supplied at runtime, 2-7
- PL/SQL
  - about, 3-1
  - datatypes
    - in a stored procedure definition, 3-10
  - functions
    - return values for, 3-13
    - mode of a parameter, 3-2
    - sample program, 6-12
- PL/SQL source files output from SQL\*Module, 5-8
- PNAME
  - command-line option, 5-14
- positional parameter association, 2-9
- preamble, 2-6
  - syntax of, B-2
  - to a module, 2-1
- precompiler default values, 5-5
- precompilers, 3-6
- privileges
  - database, 2-7
  - when running SQL\*Module application, 2-7
- procedure definitions, 2-8
- procedure name, 2-8
- procedures, 3-2
  - case of generated output code files, 3-5
  - in a module, 2-1
  - standalone, 3-3
  - stored, 3-2
  - top-level, 3-3
- program structure, 4-1
- program structure of a SQL\*Module application, 4-1

## R

---

- reserved words, C-1
- rows\_processed function, 4-4
- RPC, 3-10
  - BINDING command-line option used with, 3-6
  - call to PL/SQL, 3-10
- RPC\_GENERATE
  - command-line option, 5-15
- RPC\_GENERATE command-line option, 5-10
- running the Mod\*SQL compiler, 5-3
- running the SQL\*Module compiler, 5-3

## S

---

- SAMeDL, 1-4
- sample application DEMCALSP.A, 6-28
- sample application DEMOHOST.A, 6-15
- sample programs
  - on-line location of, 6-2
- sample tables
  - on-line location of, 6-2
- schema name required when running
  - SQL\*Module, 5-3
- SELECT\_ERROR
  - command-line option, 5-15
- semicolon
  - does not terminate cursor declaration, 2-8

- SET CONNECTION statement, 2-14
- SNAME
  - command-line option, 5-15
- source code output file, 5-7
- specification files, 1-5, 4-6
  - in Ada, 2-3
- SQL
  - commands
    - allowed in Module Language, 2-10
    - list of, 2-10
  - datatypes
    - about, 2-9
    - in the WITH INTERFACE clause, 3-10
  - identifier
    - as a cursor name, 2-7
    - in module preamble, 2-6
- SQL Ada Module Description Language, 1-4
- SQL\*Module
  - about, 1-1
  - development using Module Language, 1-4
  - executable names, 5-4
  - FIPS flagger, 0-xii
  - running the compiler, 5-3
  - standards conformance, 0-xii
  - supported features, 1-7
- SQL\*Plus
  - creating stored procedures with, 3-3
  - storing packages in a database, 5-1
- SQL\_CONTEXT datatype, 2-15
- SQL\_STANDARD package, 6-1
- SQL92 syntax, 2-8
- SQLCHECK
  - command-line option, 5-16
- SQLCODE
  - concept of, 4-1
  - in the WITH INTERFACE clause, 3-10
  - parameter, 2-13
  - return values, 4-2
  - standard type, 6-1
- SQLCODE parameter, 4-2
- SQLLIB, 5-17
- SQLSTATE
  - concept of, 4-1
  - declaring, 4-3
  - in the WITH INTERFACE clause, 3-10
  - parameter, 2-13
  - standard type, 6-1
- SQLSTATE parameter, 4-3
- SQLSTATE status variable
  - predefined status codes and conditions, 4-4
- standalone procedure, 3-3
- standards conformance, 0-xii
- status parameters
  - about, 2-13
  - in the WITH INTERFACE clause, 3-10
- STORE\_PACKAGE
  - command-line option, 5-16
- STORE\_PACKAGE command-line option
  - does a CREATE or REPLACE PACKAGE, 5-16
- stored packages, 3-3

- stored procedures
  - about, 3-2
  - created with SQL\*Module, 3-14
- string literal
  - on one line, 2-11
- STUDENTS.SQL script, 6-4
- syntax diagrams for Module Language, B-1
- system configuration file, 5-5
- system-specific Oracle documentation
  - Ada default filenames, 5-7
  - Ada default names, 5-7
  - case-sensitive command-line options, 3-5
  - filename extensions, 5-8
  - filenames and extensions, 5-6
  - invoking SQL\*Module, 5-3
  - SQL\_STANDARD package for Ada, 6-1
  - system configuration files, 5-6
- system-specific references, E-1

## T

---

- terminal encoding scheme, 4-8
- time stamp, 3-5
- top-level procedure, 3-3

## U

---

- user configuration file, 5-5
- USERID
  - command-line option, 5-17
  - compiling Module Language files, 5-3
  - generating interface procedure files, 5-3
- username
  - in AUTHORIZATION clause, 2-6

## V

---

- values of command-line options, 5-4

## W

---

- WHERE CURRENT OF clause, 2-11
- whitespace
  - not present in option lists, 5-8
- whitespace in command-line options, 5-8
- with context clause
  - for ADA, 2-3
  - for Ada, 6-1
- WITH INTERFACE clause
  - about, 3-9