



# Sun Ray™ Server Software 4.0 Administrator's Guide *for the Solaris™ Operating System*

---

Sun Microsystems, Inc.  
[www.sun.com](http://www.sun.com)

Part No. 820-0411-05  
May 2007 Beta Release

Copyright 2002—2007, Sun Microsystems, Inc., 4150 Network Circle, Santa Clara, California 95054, U.S.A. All rights reserved.

Sun Microsystems, Inc. has intellectual property rights relating to technology embodied in the product that is described in this document. In particular, and without limitation, these intellectual property rights may include one or more of the U.S. patents listed at <http://www.sun.com/patents>, and one or more additional patents or pending patent applications in the U.S. and in other countries.

This document and the product to which it pertains are distributed under licenses restricting their use, copying, distribution, and decompilation. No part of the product or of this document may be reproduced in any form by any means without prior written authorization of Sun and its licensors, if any.

Third-party software, including font technology, is copyrighted and licensed from Sun suppliers.

Parts of the product may be derived from Berkeley BSD systems, licensed from the University of California. UNIX is a registered trademark in the U.S. and other countries, exclusively licensed through X/Open Company, Ltd.

Sun, Sun Microsystems, the Sun logo, Sun Ray, Sun WebServer, Sun Enterprise, Ultra, UltraSPARC, SunFastEthernet, Sun Quad FastEthernet, HotJava, Java, JDK, JavaServer Pages, and Solaris are trademarks, registered trademarks, or service marks of Sun Microsystems, Inc. in the U.S. and other countries. All SPARC trademarks are used under license and are trademarks or registered trademarks of SPARC International, Inc. in the U.S. and other countries. Products bearing SPARC trademarks are based upon an architecture developed by Sun Microsystems, Inc.

Netscape is a trademark or registered trademark of Netscape Communications Corporation.

The OPEN LOOK and Sun™ Graphical User Interface was developed by Sun Microsystems, Inc. for its users and licensees. Sun acknowledges the pioneering efforts of Xerox in researching and developing the concept of visual or graphical user interfaces for the computer industry. Sun holds a non-exclusive license from Xerox to the Xerox Graphical User Interface, which license also covers Sun's licensees who implement OPEN LOOK GUIs and otherwise comply with Sun's written license agreements.

Federal Acquisitions: Commercial Software—Government Users Subject to Standard License Terms and Conditions.

Use, duplication, or disclosure by the U.S. Government is subject to restrictions set forth in the Sun Microsystems, Inc. license agreements and as provided in DFARS 227.7202-1(a) and 227.7202-3(a) (1995), DFARS 252.227-7013(c)(1)(ii) (Oct. 1998), FAR 12.212(a) (1995), FAR 52.227-19, or FAR 52.227-14 (ALT III), as applicable.

DOCUMENTATION IS PROVIDED "AS IS" AND ALL EXPRESS OR IMPLIED CONDITIONS, REPRESENTATIONS AND WARRANTIES, INCLUDING ANY IMPLIED WARRANTY OF MERCHANTABILITY, FITNESS FOR A PARTICULAR PURPOSE OR NON-INFRINGEMENT, ARE DISCLAIMED, EXCEPT TO THE EXTENT THAT SUCH DISCLAIMERS ARE HELD TO BE LEGALLY INVALID.

---

Copyright 2002—2007, Sun Microsystems, Inc., 4150 Network Circle, Santa Clara, California 95054, Etats-Unis. Tous droits réservés.

Sun Microsystems, Inc. a les droits de propriété intellectuelle relatants à la technologie incorporée dans le produit qui est décrit dans ce document. En particulier, et sans la limitation, ces droits de propriété intellectuelle peuvent inclure un ou plus des brevets américains énumérés à <http://www.sun.com/patents> et un ou les brevets plus supplémentaires ou les applications de brevet en attente dans les Etats-Unis et dans les autres pays.

Ce produit ou document est protégé par un copyright et distribué avec des licences qui en restreignent l'utilisation, la copie, la distribution, et la décompilation. Aucune partie de ce produit ou document ne peut être reproduite sous aucune forme, par quelque moyen que ce soit, sans l'autorisation préalable et écrite de Sun et de ses bailleurs de licence, s'il y en a.

Le logiciel détenu par des tiers, et qui comprend la technologie relative aux polices de caractères, est protégé par un copyright et licencié par des fournisseurs de Sun.

Des parties de ce produit pourront être dérivées des systèmes Berkeley BSD licenciés par l'Université de Californie. UNIX est une marque déposée aux Etats-Unis et dans d'autres pays et licenciée exclusivement par X/Open Company, Ltd.

Sun, Sun Microsystems, le Sun logo, Sun Ray, Sun WebServer, Sun Enterprise, Ultra, UltraSPARC, SunFastEthernet, Sun Quad FastEthernet, HotJava, Java, JDK, JavaServer Pages, et Solaris sont des marques de fabrique ou des marques déposées, ou marques de service, de Sun Microsystems, Inc. aux Etats-Unis et dans d'autres pays.

Toutes les marques SPARC sont utilisées sous licence et sont des marques de fabrique ou des marques déposées de SPARC International, Inc. aux Etats-Unis et dans d'autres pays. Les produits portant les marques SPARC sont basés sur une architecture développée par Sun Microsystems, Inc.

Netscape est une marque de Netscape Communications Corporation aux Etats-Unis et dans d'autres pays.

L'interface d'utilisation graphique OPEN LOOK et Sun™ a été développée par Sun Microsystems, Inc. pour ses utilisateurs et licenciés. Sun reconnaît les efforts de pionniers de Xerox pour la recherche et le développement du concept des interfaces d'utilisation visuelle ou graphique pour l'industrie de l'informatique. Sun détient une licence non exclusive de Xerox sur l'interface d'utilisation graphique Xerox, cette licence couvrant également les licenciés de Sun qui mettent en place l'interface d'utilisation graphique OPEN LOOK et qui en outre se conforment aux licences écrites de Sun.

LA DOCUMENTATION EST FOURNIE "EN L'ETAT" ET TOUTES AUTRES CONDITIONS, DECLARATIONS ET GARANTIES EXPRESSES OU TACITES SONT FORMELLEMENT EXCLUES, DANS LA MESURE AUTORISEE PAR LA LOI APPLICABLE, Y COMPRIS NOTAMMENT TOUTE GARANTIE IMPLICITE RELATIVE A LA QUALITE MARCHANDE, A L'APTITUDE A UNE UTILISATION PARTICULIERE OU A L'ABSENCE DE CONTREFAÇON.

# Contents

---

**Preface** xxiii

- 1. Sun Ray System Overview** 1
  - Computing Model 1
  - The Sun Ray System 2
    - Sun Ray DTU 2
      - Multihead Displays 3
      - Firmware Module 3
    - Sun Ray Server Software 4
      - Authentication Manager 4
      - Sessions and Services 6
      - Session Manager 6
      - Sun Management Center 8
      - CLI and Admin GUI 8
      - Data Store 8
      - Kiosk (Controlled Access) Mode 8
  - Network Components 9
    - Sun Ray Interconnect Fabric 9
    - VLAN Implementation 10
    - LAN Implementation 11

Physical Connections	11
Deployment Examples	12
Small Deployments	12
Medium to Large Deployments	12
Failover Group Scenario	13
Regional Hotdesking	13
Security Considerations	14
<b>2. Command-Line Interface</b>	<b>15</b>
Supported Commands	15
▼ To Stop Sun Ray Services	20
▼ To Start Sun Ray Services	20
Session Redirection	20
▼ To Redirect to a Different Server	21
▼ To Redirect a DTU Manually	22
▼ To List Available Hosts	22
▼ To Select a Server with the Latest Session	22
Managing User Data in the Sun Ray Data Store	23
Changing Authentication Policies	23
Enabling Multiple Administration Accounts	24
PAM Entries	24
▼ To Configure UNIX Users	25
▼ To Revert to the Old admin User	25
Administration GUI Audit Trail	25
Enabling and Disabling Device Services	26
▼ To Determine the Current State of Device Services	27
▼ To Enable USB Service	27
▼ To Disable USB Service	27
▼ To Perform a Cold Restart	28

Configuring Interfaces on the Sun Ray Interconnect Fabric	28
▼ To Add an Interface	28
▼ To Delete an Interface	29
▼ To Print the Sun Ray Private Interconnect Configuration	29
▼ To Add a LAN Subnet	30
▼ To Delete a LAN Subnet	30
▼ To Print Public LAN Subnets	30
▼ To Remove All Interfaces and Subnets	30
Managing Firmware Versions	31
▼ To Update All the DTUs on an Interface	31
▼ To Update a DTU Using the Ethernet (MAC) Address	31
Restarting the Sun Ray Data Store (SRDS)	32
▼ To Restart Sun Ray Data Store	32
Smart Card Configuration Files	32
▼ To Load a Configuration File Into the Directory	33
Configuring and Using Token Readers	33
▼ To Configure a Token Reader	34
▼ To Get a Token ID From a Token Reader	34
Using the utcapture Tool	35
▼ To Start utcapture	36
Examining Log Files	38
<b>3. Administration Tool</b>	<b>39</b>
Login Page	40
Servers Tab	42
Sessions Tab	43
Desktop Units Tab	44
▼ To Display Properties for a DTU	44
▼ To Edit a DTU's Properties	44

Multihead Groups	45
Token Readers	45
▼ To Set Up a Token Reader	45
▼ To Locate a Token Reader	45
▼ To Get Information on a Token Reader	45
Tokens Tab	46
▼ To Register a Token	46
▼ To Enable, Disable, or Delete a Token	47
Advanced Tab	48
Security Settings	48
System Policy	50
Kiosk Mode Configuration	51
Smart Card Probe Order	52
Data Store Password	53
Log Files Tab	54
<b>4. Peripherals for Sun Ray DTUs</b>	<b>55</b>
Device Nodes and USB Peripherals	55
Device Nodes	56
Device Links	57
Device Node Ownership	57
Hotdesking and Device Node Ownership	57
Mass Storage Devices	58
Device Nodes and Links	58
Mount Points	58
Device Ownership and Hotdesking	59
Mass Storage Devices and NSCM	59
Common Disk Operations	59

Attached Printers	60
Printer Setup	61
▼ To Set Up a Printer	61
Non-PostScript Printers	63
PDA Synchronization	63
PDASync for Solaris Application on Sun Ray DTUs	63
▼ To Set Up the PDASync Application on a Sun Ray DTU	63
Adapters	64
libusb	64
<b>5. Hotdesking (Mobile Sessions)</b>	<b>67</b>
NSCM Session	67
Sun Ray Mobile Session Login Dialog Box	68
Token Reader Icon	68
▼ To Log In to an NSCM Session	69
Disconnecting an Active NSCM Session	70
Hot Key	70
▼ To Disconnect the Current Session via utdetach	70
▼ To Terminate the Current Session	71
▼ To Reconfigure the Disconnect Hot Key Combination	71
▼ To Customize the Short Cut for Disconnecting an NSCM Session	71
NSCM and Failover Groups	72
Configuring the Authentication Manager for NSCM Sessions	72
▼ To Enable NSCM Sessions From the Administration Tool	73
▼ To Enable NSCM Sessions From a Command Line	75
Regional Hotdesking	76
Functional Overview	76
Site Requirements	77
Providing Site Integration Logic	78

- ▼ To Configure a Site-specific Mapping Library 78
- Token Readers 79
- ▼ To Configure the Sample Data Store 79
- ▼ To Disable Regional Hotdesking 80

**6. Encryption and Authentication 81**

- Introduction 81
- Security Configuration 82
  - Security Mode 82
  - Session Security 83
  - Security Status 84

**7. Deployment on Shared Networks 85**

- Sun Ray DTU Initialization Requirements 86
  - DHCP Basics 86
  - DHCP Parameter Discovery 87
  - DHCP Relay Agent 88
- Network Topology Options 88
  - Directly-Connected Dedicated Interconnect 90
  - Directly-Connected Shared Subnet 90
  - Remote Shared Subnet 90
- Network Configuration Tasks 91
  - Preparing for Deployment 91
  - Deployment on a Directly-Connected Dedicated Interconnect 92
    - Directly-Connected Dedicated Interconnect: Example 93
  - Deployment on a Directly-Connected Shared Subnet 95
    - Directly-Connected Shared Subnet: Example 1 96
    - Directly-Connected Shared Subnet: Example 2 98
  - Deployment on a Remote Subnet 99



Remote Shared Subnet: Example 1	101
Remote Shared Subnet: Example 2	104
Network Performance Requirements	107
Packet Loss	107
Latency	108
Out-of-Order Packets	108
Encapsulated Options	108
Troubleshooting Tools	110
utcapture	110
utquery	110
OSD Icons	110
Remote Configuration	111
Firmware Download	112
Routerless VPN Capability	113
Pop-up GUI	113
Remote Loading of Configuration Data	118
Ports and Protocols	120
<b>8. Monitoring the Sun Ray System</b>	<b>123</b>
Sun Management Center (SunMC) Software Features	123
Additional Sun Management Center Modules	125
Setting Up the Monitoring Environment	125
▼ To Set Up the Monitoring Environment	125
▼ To Create an Object	126
Setting Alarms	126
▼ To Set an Alarm	126
▼ To Start Monitoring	129
Setting Monitoring Guidelines	132
Sun Ray System Panel	132

▼	To Display the Sun Ray System Panel	132
▼	To Refresh the Sun Ray System Panel	133
▼	To Set Alarms	133
	Sun Ray Services Panel	134
	Failover Group Panel	135
	Interconnect Panel	135
▼	To Set an Alarm for Running Out of Addresses	136
	Desktops Panel	136
▼	To Add a DTU to Be Monitored	137
▼	To Delete a DTU to Exclude Monitoring	137
	Using Other Monitoring Programs	138
	Removing the Sun Ray Module from SunMC	140
▼	To Remove the Sun Ray module	140
<b>9.</b>	<b>Multihead Administration</b>	<b>141</b>
	Multihead Groups	142
	Multihead Screen Configuration	142
	Multihead Screen Display	144
	Multihead Administration Tool	144
▼	To Turn On Multihead Policy From the Command Line	144
▼	To Turn On Multihead Policy Using the Administration Tool	144
▼	To Create a New Multihead Group	145
	XINERAMA	147
	Session Groups	148
	Authentication Manager	148
<b>10.</b>	<b>Kiosk Mode</b>	<b>151</b>
	Kiosk Mode Functionality	151
	Enabling Kiosk Mode	152

Enabling Kiosk Mode Using the CLI	152
Enabling Kiosk Mode with the Admin GUI	154
Overriding Kiosk Mode Policy	155
▼ To Override Kiosk Mode Policy from the GUI	155
Building the Kiosk Mode Environment	157
▼ To Configure Kiosk Mode Settings	157
▼ To Add an Application	158
Kiosk Mode and Security	159
Failover	159
Preserving Controlled Access Mode (CAM) Prototype Data	160
▼ To Preserve CAM Prototype Data	160
▼ To Restore CAM Prototype Data	160
Migrating from Controlled Access Mode (CAM) to Kiosk Mode	160
▼ To Migrate from CAM to Kiosk Mode	161
Failover Group Migration	161
Kiosk Mode Session Using Sun Ray Connector for Windows OS	161
Session Descriptor	162
Session Script	162
Session Script Arguments	162
Non-Sun Ray Connector Arguments	163
Sun Ray Connector Arguments	163
Supplemental Information	163
Follow-Me-Printing	164
Windows Session Locking	165
<b>11. Failover Groups</b>	<b>167</b>
Failover Group Overview	168
Setting Up IP Addressing	170
Setting Up Server and Client Addresses	170

Server Addresses	171
Configuring DHCP	172
Coexistence of the Sun Ray Server With Other DHCP Servers	173
Administering Other Clients	173
▼ To Set Up IP Addressing on Multiple Servers Each With One Sun Ray Interface	173
Group Manager	176
Redirection	177
Group Manager Configuration	177
▼ To Restart the Authentication Manager	178
Load Balancing	178
▼ To Turn Off the Load Balancing Feature	178
Setting Up a Failover Group	179
Primary Server	179
▼ To Specify a Primary Server	180
▼ To Specify a Dedicated Primary Server	180
Secondary Server	180
▼ To Specify Each Secondary Server	180
▼ To Add Additional Secondary Servers	180
Removing Replication Configuration	181
▼ To Remove the Replication Configuration	181
Viewing the Administration Status	181
▼ To Show Current Administration Configuration	181
Viewing Network (Failover Group) Status	181
▼ To View Failover Group Status	181
Recovery Issues and Procedures	183
Primary Server Recovery	183
▼ To Rebuild the Primary Server Administration Data Store	183
▼ To Replace the Primary Server with a Secondary Server	184

Secondary Server Recovery	185
Setting Up a Group Signature	185
▼ To Change the Group Manager Signature File	186
Taking Servers Offline	186
▼ To Take a Server Offline	186
▼ To Bring a Server Online	186
<b>A. User Settings</b>	<b>187</b>
Supported Devices and Libraries	187
Supported Mass Storage Devices	187
Sun Ray DTU Settings	188
▼ To Change the Sun Ray Settings	188
Monitor Settings	189
Hot Key Preferences	190
Hot Key Values	191
▼ To Change the Hot Key for the Settings GUI	191
▼ To Change the Hot Key Used to Detach NSCM Sessions	192
▼ To Change the Hot Key Setting for a Single User	192
Power Cycling a Sun Ray DTU	193
▼ To Power Cycle a Sun Ray DTU	193
▼ To Perform a Soft Reset	193
▼ To Kill a User's Session	193
<b>B. Troubleshooting and Tuning Tips</b>	<b>195</b>
Understanding OSD	195
OSD Icon Topography	195
Sun Ray Desktop Unit Startup	200
▼ If this icon stays on for more than 10 seconds	200
▼ If this icon stays on for more than 10 seconds	201

▼ Actions to Take	202
▼ If the icon displays for more than a few seconds or if the DTU continues to reset after the icon is displayed	202
Wait Icon Cursor for Default Session Type	204
▼ To Identify a Hung Session	204
▼ To Kill a Hung Session	204
▼ Actions to Take	205
▼ Actions to Take	206
Session Connection Failures	207
▼ Actions to Take	208
Firmware Download Diagnostics	209
Firmware Download OSD	210
▼ Actions to Take	210
▼ Actions to Take	211
Token Reader Icons	212
▼ Actions to Take	213
Authentication Manager Errors	215
Troubleshooting USB Mass Storage Devices	217
Device Nodes Are Not Created	217
Device Is Not Automatically Mounted	217
Device Is Not Automatically Unmounted	218
Audio	218
Audio Device Emulation	218
Audio Malfunction	219
▼ To Activate the Redirection Library	219
PDA Synchronization Issues	219
Performance Tuning	220
General Configuration	220
Applications	221

Sluggish Performance	221
Screensaver Resource Consumption	221
▼ To Disable Screensaver Hacks on Solaris Systems	222
Multihead Displays	222
Monitor Display Resolution Defaults to 640 x 480	222
▼ To Correct or Reset the Screen Resolution	222
Old Icons (Hourglass with Dashes Underneath) Appear on Display	223
Port Currently Owned by Another Application	223
Design Tips	223
Troubleshooting the Sun Management Center	224
No Sun Ray Object	224
▼ To Load the Sun Ray Module	224
No Sun Ray Module	225
▼ To Activate the Sun Ray Module	226
<b>Glossary</b>	<b>227</b>
<b>Index</b>	<b>239</b>





# Figures

---

- FIGURE 1-1 Authentication and Session Manager Interaction 6
- FIGURE 1-2 Sun Ray System with a Dedicated Interconnect Fabric 9
- FIGURE 1-3 Example of Shared Physical Resources in Multiple VLANs Configuration 10
- FIGURE 1-4 Small Deployment Scenario 13
- FIGURE 1-5 Simple Failover Group 14
- FIGURE 2-1 The Server Selection (`utselect`) GUI 21
- FIGURE 2-2 Using a Token Reader to Register Smart Cards 33
- FIGURE 3-1 User Name Challenge Screen 41
- FIGURE 3-2 Top-level Servers Tab 42
- FIGURE 3-3 Sessions Tab Displays Active and Idle Sessions 43
- FIGURE 3-4 Desktop Units Tab 44
- FIGURE 3-5 Tokens Tab 46
- FIGURE 3-6 The Security Tab 48
- FIGURE 3-7 System Policy Tab 50
- FIGURE 3-8 Edit Kiosk Mode Tab 51
- FIGURE 3-9 Edit Smart Card Probe Order 52
- FIGURE 3-10 Use the Data Store Password Tab to Change the Admin Password 53
- FIGURE 3-11 Sample Excerpt From an Authentication Log 54
- FIGURE 5-1 Sun Ray Mobile Session Login Dialog Box 68
- FIGURE 5-2 User name Entry 69

FIGURE 5-3	User Password Entry	70
FIGURE 5-4	Change Policy Window	74
FIGURE 6-1	Sun Ray Security Configuration Tab	83
FIGURE 7-1	Network Topologies for Sun Ray DTU Deployment	89
FIGURE 7-2	Sun Ray Network Topology	92
FIGURE 7-3	Pop-up GUI Main Menu (Part I)	115
FIGURE 7-4	Pop-up GUI Main Menu (Part II)	115
FIGURE 7-5	DHCP Configuration Selection on the Setup TCP/IP OSD	116
FIGURE 7-6	Enable VPN Configuration Policy Toggle	116
FIGURE 7-7	Download Configuration Selection	117
FIGURE 7-8	Sample VPN Configuration File	119
FIGURE 8-1	Sun Management Center Details Window	127
FIGURE 8-2	Example Using the Failover Group Panel	127
FIGURE 8-3	Alarm Window	129
FIGURE 8-4	Details Window With Alarms	130
FIGURE 8-5	Alarm Summary Window	131
FIGURE 8-6	Sun Ray System Panel	132
FIGURE 8-7	Sun Ray Services (daemons) Panel	134
FIGURE 8-8	Failover Group Panel	135
FIGURE 8-9	Interconnect Panel	136
FIGURE 8-10	Desktops Panel	137
FIGURE 8-11	Example of Interoperability	139
FIGURE 9-1	The Multihead Screen Display	144
FIGURE 9-2	utmhconfig GUI Lists Multihead Groups and Details	145
FIGURE 9-3	Create New Multiheaded Group Pop-up Dialog Box	146
FIGURE 9-4	Setup Display for the New Multihead Group	146
FIGURE 9-5	Completed Multihead Group List With Active Finish Button	147
FIGURE 9-6	Authentication Manager Flowchart for the Primary DTU	149
FIGURE 9-7	Authentication Manager Flowchart for the Secondary DTU	150
FIGURE 10-1	Kiosk Mode Enabled for Non-Card Users	154

FIGURE 10-2	Edit Kiosk Mode Tab	156
FIGURE 11-1	Simple Failover Group	168
FIGURE 11-2	Redundant Failover Group	170
FIGURE 11-3	Network Status Screen	182
FIGURE A-1	Settings Screen	188
FIGURE B-1	Layout of Old (left) and New (right) OSD Icons	196
FIGURE B-2	DTU Startup OSD	200
FIGURE B-3	Network Connection Verified	201
FIGURE B-4	Waiting to Connect to Authentication Manager	202
FIGURE B-5	Redirection OSD	203
FIGURE B-6	Wait for Session OSD	203
FIGURE B-7	Bus Busy	205
FIGURE B-8	No Ethernet Signal	205
FIGURE B-9	Ethernet Address	206
FIGURE B-10	Ethernet Address OSD with Different Encryption and Authentication States	207
FIGURE B-11	Session Refused by Client	207
FIGURE B-12	DHCP Broadcast Failure	208
FIGURE B-13	Establishing a VPN Connection	209
FIGURE B-14	VPN Connection Established	209
FIGURE B-15	OSD Icon 4 Displays Firmware Download Error Messages	210
FIGURE B-16	Firmware Download in Progress	210
FIGURE B-17	Saving PROM Software	211
FIGURE B-18	Firmware Download Failed	212
FIGURE B-19	Card Reader OSD	212
FIGURE B-20	Card Read Error OSD	213
FIGURE B-21	Prompt for Card Insertion OSD	213
FIGURE B-22	Access Denied OSD	214
FIGURE B-23	Module Panel	225



# Tables

---

TABLE 2-1	Supported Commands	16
TABLE 2-2	Key User Fields	23
TABLE 2-3	<code>utrestart</code> Commands	24
TABLE 2-4	Data Elements Displayed	35
TABLE 2-5	<code>utcapture</code> Options	36
TABLE 2-6	Log Files	38
TABLE 4-1	Definitions of Naming Conventions	56
TABLE 4-2	Commands for Common Disk Operation on SPARC and x86 Platforms	59
TABLE 4-3	Open Source <code>libusb</code> Applications	65
TABLE 7-1	DHCP Service Parameters Available	87
TABLE 7-2	Vendor-specific DHCP Options	106
TABLE 7-3	Prompt Mode Key Codes	114
TABLE 7-4	Pop-up GUI Menu Configuration Values	118
TABLE 7-5	Sun Ray DTU-to-Server Ports and Protocols	120
TABLE 7-6	Sun Ray Server-to-Server Protocols	121
TABLE 8-1	Three Components of Sun Management Center Software	124
TABLE 8-2	Properties on the Sun Ray System Panel	133
TABLE 8-3	Desktop Information	137
TABLE 10-1	Kiosk Mode Settings	157
TABLE 10-2	Kiosk Session Descriptors	162

<a href="#">TABLE 11-1</a>	Configuring Five Servers for 100 DTUs	171
<a href="#">TABLE 11-2</a>	Available Options	176
<a href="#">TABLE A-1</a>	Sun Ray Settings Properties Files	190
<a href="#">TABLE A-2</a>	Specific Hot Key Values	191
<a href="#">TABLE B-1</a>	Icon Messages	196
<a href="#">TABLE B-2</a>	DCHP State Codes	198
<a href="#">TABLE B-3</a>	Power LED	199
<a href="#">TABLE B-4</a>	Firmware Download Error Codes and Messages	199
<a href="#">TABLE B-5</a>	Error Message Examples	216

# Preface

---

The *Sun Ray Server Software 4.0 Administrator's Guide for the Solaris™ Operating System* provides instructions for setting up, administering, monitoring, and troubleshooting a system of Sun Ray™ Desktop Units (DTUs) and their server or servers. It is written for system administrators who are already familiar with the Sun Ray™ computing paradigm and have substantial networking knowledge. This guide may also be useful for those interested in customizing Sun Ray systems.

---

## Before You Read This Book

This guide assumes that you have installed the Sun Ray Server Software on your server from the Sun Ray Server Software 4.0 CD or the Electronic Software Download (ESD) and that you have added the required patches.

---

## How This Book Is Organized

[Chapter 1](#) gives an overview of the Sun Ray system.

[Chapter 2](#) describes the command-line interface.

[Chapter 3](#) describes the Administration Tool.

[Chapter 4](#) describes peripherals for Sun Ray DTUs.

[Chapter 5](#) describes mobile sessions, also known as Hotdeksing.

[Chapter 6](#) gives a brief description of traffic encryption between Sun Ray clients and servers and server-to-client authentication.

[Chapter 7](#) discusses network requirements, including LAN, VLAN, and dedicated interconnect options, switch requirements, and other network topology issues.

[Chapter 8](#) describes how to monitor the Sun Ray System using Sun Management Center software.

[Chapter 9](#) describes how to implement multihead and XINERAMA on a Sun Ray system.

[Chapter 10](#) describes how to customize Sun Ray Server Software for controlled access mode.

[Chapter 11](#) discusses failover groups.

[Appendix A](#) discusses user issues and concerns.

[Appendix B](#) provides troubleshooting information, including error messages from the Authentication Manager.

This manual also contains a glossary and an index.

---

## Using UNIX Commands

This document does not contain information on basic UNIX® commands and procedures, such as shutting down the system, booting the system, or configuring devices. This document does, however, contain information about specific Sun Ray system commands.



---

# Typographic Conventions

Typeface	Meaning	Examples
AaBbCc123	The names of commands, files, and directories; on-screen computer output	Edit your <code>.login</code> file. Use <code>ls -a</code> to list all files. % You have mail.
<b>AaBbCc123</b>	What you type, when contrasted with on-screen computer output	% <b>su</b> Password:
<i>AaBbCc123</i>	Book titles, new words or terms, words to be emphasized	Read Chapter 6 in the <i>User's Guide</i> . These are called <i>class</i> options. You <i>must</i> be superuser to do this.
	Command-line variable; replace with a real name or value	To delete a file, type <code>rm filename</code> .

---

# Shell Prompts

Shell	Prompt
C shell	<i>machine_name</i> %
C shell superuser	<i>machine_name</i> #
Bourne shell and Korn shell	\$
Bourne shell and Korn shell superuser	#

---

## Related Documentation

Application	Title	Part Number
Installation	<i>Sun Ray Server Software 4.0 Installation and Configuration Guide for the Solaris Operating System</i>	820-0413
Release Notes	<i>Sun Ray Server Software 4.0 Release Notes for the Solaris Operating System</i>	820-0417-

---

## Accessing Sun Documentation

You can view, print, or purchase a broad selection of Sun documentation, including localized versions, at:

<http://www.sun.com/documentation>

---

## Sun Welcomes Your Comments

Sun is interested in improving its documentation and welcomes your comments and suggestions. You can email your comments to Sun at:

[docfeedback@sun.com](mailto:docfeedback@sun.com)

Please include the part number (820-0411) of your document in the subject line of your email.

# Sun Ray System Overview

---

Although thin client computing has been discussed and attempted for many years, Sun Ray is the first implementation to offer both workstation-like user functionality and sufficient speed and reliability to be suitable for mission-critical applications. Originally developed on Sun's Solaris™ Operating System, Sun Ray Server Software is now also supported on Red Hat Enterprise Linux Advanced Server 4 and SuSE Linux Enterprise Server 9. It also supports many USB peripheral devices, and LAN and low-bandwidth WAN deployment.

---

## Computing Model

The Sun Ray system employs a network-dependent model in which all computing is performed on a server, with input and output data passed back and forth between the Sun Ray server and the Sun Ray Desktop Units (DTUs). Nearly any Sun server with sufficient capacity can be configured as a Sun Ray server so long as it runs a supported version of the Solaris operating system or one of the supported flavors of Linux.

Various models of Sun Ray DTU are available, differing primarily with respect to size and type of screen; however, all Sun Ray DTUs also include a smart card reader, a keyboard, and a mouse. Sun Ray DTUs have no local disks, operating systems, or applications; they are therefore considered *stateless*. This is what makes them true, or “ultra” thin clients, and it is what makes them inexpensive to maintain as well as extremely secure, both from an intellectual property perspective and for government work. The ability to use USB mass storage devices is administered centrally so that sites with security requirements can easily remove the sort of risk imposed by PCs and other fat clients, which allow the theft of data in case a physical device is stolen.

Because effective client-server network traffic often relies on the rapid movement of large numbers of packets, an optimal Sun Ray implementation requires a well-designed network. Most large implementations include at least one *failover group* to ensure uninterrupted service whenever a server goes off-line.

Once a failover group is set up, Sun Ray Server Software provides automatic load balancing to optimize performance by spreading the computing load among the servers in the group. If a server is taken out of service, the Group Manager on each remaining server tries to distribute that server's sessions evenly among the remaining servers. The load balancing algorithm takes into account each server's load and capacity (number and speed of its CPUs) so that larger or less heavily loaded servers host more sessions. These concepts are addressed in [Chapter 11](#) and in the *Sun Ray Server Software 4.0 Installation and Configuration Guide*.

Sessions—groups of services controlled by the Session Manager and associated with a user through an authentication token—reside on a server and are directed to a Sun Ray DTU. Because Sun Ray DTUs are stateless, a session can be redirected to any Sun Ray DTU on the appropriate network or subnetwork when a user logs in or inserts a smart card.

While the session continues to reside on a server, it appears to follow the user to the new DTU. This functionality, called *session mobility*, is the key architectural feature that enables *hotdesking*—the ability of users to access their sessions from any DTU on their network. In early versions of Sun Ray Server Software, mobile sessions were possible only with smart cards. It is now possible to enable hotdesking with or without smart cards. In addition, *regional hotdesking* now lets users access their sessions from increasingly remote locations.

---

## The Sun Ray System

The Sun Ray system consists of Sun Ray DTUs, servers, server software, and the physical networks that connect them.

### Sun Ray DTU

The Sun Ray desktop unit (DTU) delivers and may exceed the full functionality of a workstation or a multimedia PC. The key features include:

- 24-bit, 2-D accelerated graphics up to 1920 x 1200 resolution at 72 Hz (640 x 480 at 60 Hz is the lowest resolution)
- Multichannel audio input and output capabilities
- Smart card reader
- USB ports that support hot-pluggable peripherals

- Serial port (for the Sun Ray 170 and later models)
- EnergyStar™ compliance
  - No fan, switch, or disk
  - Very low power consumption

The DTU acts as a frame buffer on the client side of the network. Applications run on the server and render their output to a *virtual frame buffer*. Sun Ray server software formats and sends the rendered output to the appropriate DTU, where the output is interpreted and displayed.

From the point of view of network servers, Sun Ray DTUs are identical except for their Ethernet MAC addresses. If a DTU ever fails, it can easily be replaced.

IP addresses are leased to each Sun Ray DTU when it is connected and can be reused when the DTU is disconnected. IP address leasing is managed by the Dynamic Host Configuration Protocol (DHCP). In cases where they already exist on a network that will support Sun Ray DTUs, separate DHCP servers may be useful for tasks such as assigning IP addresses and network parameters to the DTUs. The use of separate DHCP servers is not required; however, because they require static IP addresses, Sun Ray Servers cannot be DHCP clients. These questions are discussed in [Chapter 7](#).

## Multihead Displays

Sun Ray Server Software supports the use of multiple displays connected to a single keyboard and pointer. This functionality is important for users who need extra screen real estate, for instance, to monitor many applications or systems simultaneously or to accommodate a single application, such as a large spreadsheet, across multiple screens. To use multiple screens, the administrator sets up multihead groups, consisting of two or more DTUs, for those users who need them. Administration of multihead groups is explained in [Chapter 9](#).

## Firmware Module

A small firmware module in each Sun Ray DTU can be updated from the server. The firmware module checks the hardware with a power-on self test (POST) and initializes the DTU. The DTU contacts the server to authenticate the user, and it also handles low-level input and output, such as keyboard, mouse, and display information. If there is a problem with the DTU, the module displays an on-screen display (OSD) icon to make it easier to diagnose. OSD icons are described in [Appendix B](#).

# Sun Ray Server Software

Sun Ray server software allows the administrator to configure network connections, select an authentication protocol, administer authentication tokens, define desktop properties, monitor the system, and troubleshoot a wide variety of administration problems.

Sun Ray server software includes:

- User authentication and access control
- Encryption between the Sun Ray server and DTUs
- System administration tools
- Session management
- Device management, including application-level USB access
- Virtual device drivers for audio and serial, parallel, and mass storage USB devices

Sun Ray server software enables direct access to all Solaris X11 applications. Third-party applications running on the Sun Ray server can provide access to Microsoft Windows NT applications and a variety of legacy (mainframe) applications. The Sun Ray Connector for Windows enables Sun Ray users to access applications running on remote Windows Terminal Servers (see the [Sun Ray™ Connector for Windows OS, Version 2.0 Installation and Administration Guide](#)).

## Authentication Manager

The Authentication Manager implements the chosen policies for identifying and authenticating users on Sun Ray DTUs. The Authentication Manager uses pluggable components called *modules* to implement various site-selectable authentication *policies*.

The Authentication Manager also verifies user identities and implements site access policies defined by the administrator. It also supplies an audit trail of the actions of users who have been granted administrative privileges over Sun Ray services. The Authentication Manager is not visible to the user.

The interaction between the Authentication Manager and the DTU works as follows:

1. A user accesses a DTU.
2. The DTU sends the user's *token* information to the Authentication Manager and requests access. If a smart card is inserted in the DTU, the smart card's type and ID are used as the token. If not, the DTU's Ethernet address is used as a *pseudo-token*.
3. If the Authentication Manager runs through the entire list of modules and no module takes responsibility for the request, the user is denied access.

4. If the user is accepted, the Authentication Manager starts an X Windows session which takes the user to the login screen. Solaris implementations use the `dtlogin` screen; Linux implementations use GDM.

Normally, the Sun Ray DTU looks for the `AuthSrvr` DHCP option and contacts that address. If that field has not been supplied, or if the server does not respond, the DTU sends a broadcast request for any Authentication Manager on its subnet.

As an alternative, the administrator can supply a list of servers. If the authentication list is specified, only addresses on the list are checked. The Authentication Manager addresses are tried in order until a connection is made.

The site administrator can construct a combination of the different modules and their options to implement a policy tailored to the site's needs.

The modules are:

- **StartSession**

Any type of token is accepted. Users are automatically passed through to the login window. This module is designed primarily for implementations in which Sun Ray DTUs replace workstations or PCs.

- **Registered**

The token is accepted *only* if the token has been registered in the Sun Ray data store *and* the token is enabled. If the token does not meet these conditions, it is rejected. If the token is accepted, the user is passed through to the login window. This module is designed for sites that want to restrict access to only certain users or DTUs.

Users can be registered in two ways, reflecting two possible policy decisions for the administrator:

- **Central Registration**

The administrator assigns smart cards and/or DTUs to authorized users and registers users' tokens in the Sun Ray data store.

- **Self-Registration**

Users register themselves in the Sun Ray data store. If this mode is enabled and the Authentication Manager is presented with an unregistered token, the user is prompted with a registration window. In this case, the user provides the same information a site administrator would request.

If self-registration is enabled, users can still be registered centrally. If a token has been registered but disabled, the user cannot re-register the token; the user must contact the site administrator to re-enable the token.

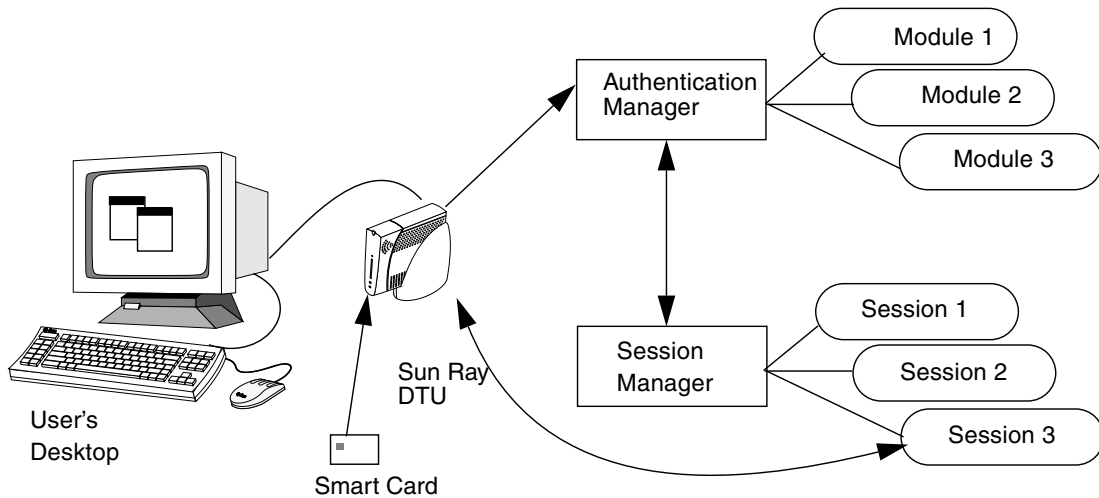

**FIGURE 1-1** Authentication and Session Manager Interaction

## Sessions and Services

A *session* consists of a group of services controlled by the Session Manager.

The session is associated with a user through an authentication token. A *service* is any application that can connect directly to the Sun Ray DTU. This can include audio, video, X servers, and device control of the DTU. For example, `dtmail` is not a service because it is accessed through an X server.

## Session Manager

The Session Manager interacts with the Authentication Manager and directs services to the user. The Session Manager is used at start up for services, for managing screen real estate, and as a rendezvous point for the Authentication Manager.

The Session Manager keeps track of sessions and services by mapping services to sessions and binding and unbinding related services to or from a specific DTU. The Session Manager takes authentication only from authorized Authentication Managers listed in the `/etc/opt/SUNWut/auth.permit` file.

The steps below describe how the process starts and ends:

1. After a user's token is authenticated, the Authentication Manager determines whether a session exists for that token. If a session does not exist, the Authentication Manager asks the Session Manager to create a session and then



starts the appropriate service(s) for the session according to the authentication policy decisions taken by the administrator. Creating a session usually involves starting an `Xserver` process for the session.

2. When services are started, they join the session explicitly by contacting the Session Manager.
3. The Authentication Manager informs the Session Manager that the session associated with the token is to be connected to a specific Sun Ray DTU. The Session Manager then informs each service in the session that it should connect directly to the DTU.
4. The Authentication Manager determines that the session associated with a token should be disconnected from a DTU. The Authentication Manager notifies the Session Manager which, in turn, notifies all the services in the session to disconnect.
5. The Session Manager mediates control of the screen real estate between competing services in a session and notifies the services of changes in screen real estate allocation.



---

**Caution** – It is important to keep the session ID private. If the user’s session ID is revealed, unauthorized applications can connect directly to the DTU. The `xprop(1)` command can reveal a user’s secret session ID. Careless use of the `xhost(1)` command (for example, typing `xhost +`) can allow an intruder to use `xprop` to capture a user’s session ID. This action can expose the user’s screen images and keyboard input to anyone interested.

---

---

**Tip** – Use `xhost user name@system` to enable only those people you specify to access the display and the user’s DTU.

---

The Session Manager is consulted only if the state of the session changes or if other services are added. When a user’s token is no longer mapped to a DTU (for example, when a card is removed), the Session Manager disconnects the services from the DTU, but the services remain active on the server. For example, programs attached to the X server continue to run although their output is not visible. The Session Manager daemon must continue running all the time.

---

**Note** – To verify that the Session Manager daemon is running, use the `ps` command and look for `utssessiond`.

---

If the Authentication Manager quits, the Session Manager disconnects all the sessions it authorized and tells them that they have to be re-authenticated. These services are disconnected but still active. If the Session Manager is disrupted, it restarts automatically. Each service contacts the Session Manager to request reattachment to a particular session.

## Sun Management Center

The Sun™ Management Center (SunMC) software monitors managed objects in the Sun Ray system. Objects that can be managed by default include the Sun Ray system itself, Sun Ray services, failover groups, interconnects, and desktops.

Each managed object is monitored separately and has independent alarm settings.

Sun Management Center software also monitors Sun Ray Server Software daemons that authenticate users, start sessions, manage devices, and handle DHCP services. [Chapter 8](#) describes how to use the SunMC to monitor a Sun Ray system. For problems with the SunMC, see [“Troubleshooting the Sun Management Center” on page 224](#).

## CLI and Admin GUI

Sun Ray Server Software has both a command-line interface (CLI) and a graphical user interface for administrative functions. The Sun Ray Administration Tool (Admin GUI) has been completely rewritten for the 4.0 release to present a clearer view of administrative functions, with tab-based navigational model and context-sensitive help.

## Data Store

Sun Ray Server Software 4.0 provides a private data store service, the Sun Ray Data Store (SRDS), for access to SRSS administration data across failover groups.

## Kiosk (Controlled Access) Mode

Sun Ray DTUs are becoming more common in public locations, such as airports, where anonymous users have limited access to specific applications. Sun Ray Kiosk mode software has been revised for the 4.0 release. It is described in [Chapter 10](#), along with instructions for migrating configuration data from the previous Controlled Access Mode (CAM).

# Network Components

In addition to the servers, server software, DTUs, smart cards, and peripheral devices, such as local printers, the Sun Ray system needs a well-designed network, configured in one of several possible ways, including:

- Dedicated interconnect
- VLAN (Virtual Local Area Network)
- LAN (Local Area Network), with or without network routers
- Low-bandwidth<sup>1</sup> WAN (Wide Area Network)
- VPN (Virtual Private Network)

Various types of network configuration are discussed in depth in [Chapter 7](#).

## Sun Ray Interconnect Fabric

The first Sun Ray implementations relied on dedicated interconnects, using physically dedicated Ethernet networks or logically dedicated networks. Sun Rays can also be deployed on existing Local Area Network (LAN) infrastructure, eliminating the requirement for a dedicated interconnect.

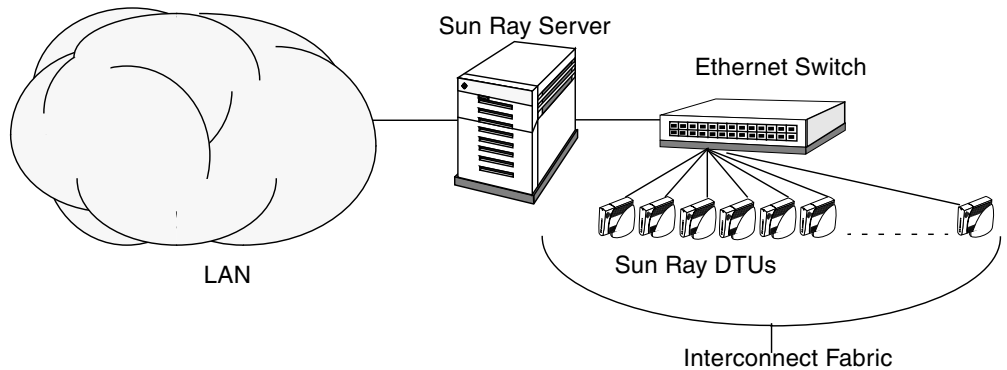

**FIGURE 1-2** Sun Ray System with a Dedicated Interconnect Fabric

The Sun Ray interconnect fabric is based on 10/100BASE-T Ethernet technology, using layer-2 or layer-3 switches and Category 5 wiring. Each Sun Ray DTU is attached to the interconnect fabric through its built-in 10/100BASE-T interface.

The following sections illustrate some conservative methods of providing good desktop performance to Sun Ray users at a low cost. Many other network scenarios are possible.

---

1. Bandwidth less than 2 Mbps.

## VLAN Implementation

VLANs logically partition a single physical interconnect into two or more broadcast domains. VLANs are commonly configured to implement virtual subnets in a shared physical interconnect. However, because VLANs must share backplane and link bandwidth, they are not true dedicated interconnects.

Implementing a Sun Ray interconnect through VLANs creates a logically dedicated connection, but can also mean sharing physical resources with uncontrolled, non-Sun Ray traffic. These resources could be the limited backplane bandwidth within a switch or on a link that carries multiple VLANs between switches (see [FIGURE 1-3](#)). If these resources are consumed by other devices, significant amounts of Sun Ray DTU traffic might be dropped and the results seen as horizontal bands or blocks on the user's display.

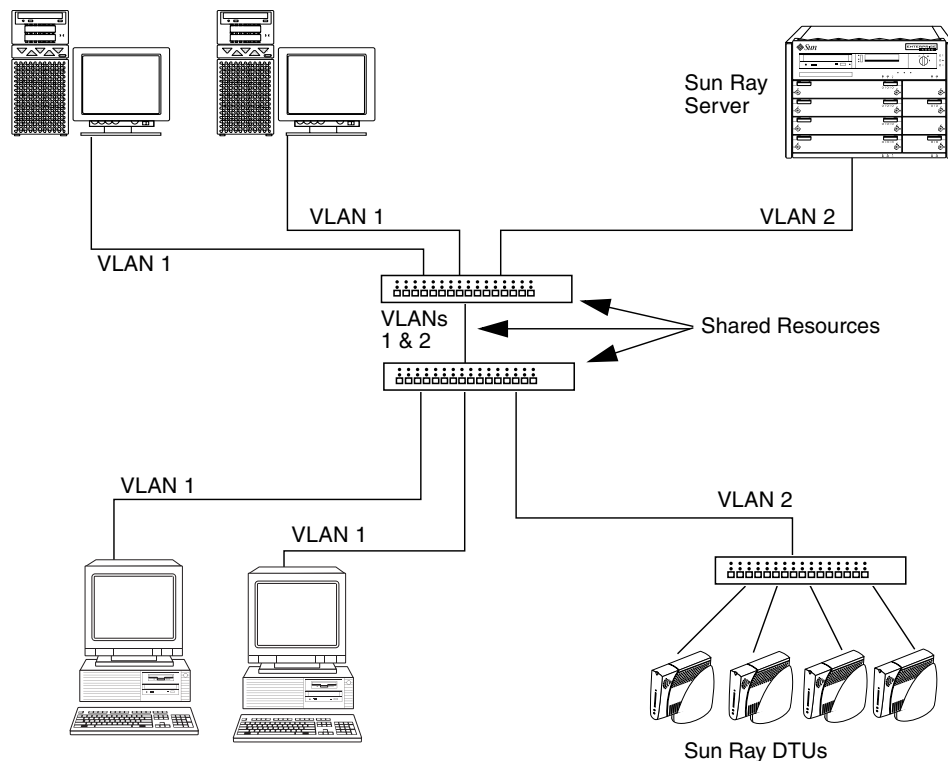

**FIGURE 1-3** Example of Shared Physical Resources in Multiple VLANs Configuration

Since switch manufacturers configure their products differently, please refer to the documentation provided with your switch and refer all questions relating to setting up or configuring VLANs to your switch manufacturer.

Implementing the interconnect with a physically dedicated and isolated set of Ethernet switches is recommended because it is easy and reliable. For instance:

- Only layer 2 switches are required.
- The only switch configuration required is to enable fast boot times.
- No ongoing switch configuration and management is required.
- Issues of bandwidth and poor topology are greatly reduced.

## LAN Implementation

With Sun Ray DTUs deployed on a LAN, users can exercise session mobility across a much larger “domain”—a huge convenience. For basic instructions on configuring different types of networks for Sun Ray implementation, see [“Basic Network Topology” on page 34](#) of the *Sun Ray Server Software 4.0 Installation and Configuration Guide*. For a more detailed discussion of network taxonomy and configuration, see [“Deployment on Shared Networks” on page 85](#).

## Physical Connections

The physical connection between the Sun Ray server and Sun Ray clients relies on standard switched Ethernet technology.

To boost the power of the interconnect and shield Sun Ray DTU users from the network interaction taking place at every display update, 100 Mbps switches are preferred.

There are two basic types of 100 Mbps switches:

- Low-capacity switches—These switches have 10/100 Mbps interfaces for each port.
- High-capacity switches—These switches have 10/100 Mbps interfaces for each terminal port, but one or more gigabit interfaces to attach to the server.

Either type of switch can be used in the interconnect. They can be managed or unmanaged; however, some managed switches may require basic configuration in order to be used on a Sun Ray network.

Server-to-switch bandwidth should be scaled based on end-user multiplexing needs so that the server-to-switch link does not become overly saturated. Gigabit uplink ports on the switch provide high-bandwidth connections from the server, thus increasing the number of supportable clients. The distance between the server and the switch can also be extended using gigabit fiber-optic cabling.

The interconnect may be completely dedicated and private, or a VLAN, or it may be part of the corporate LAN. For private interconnects, the Sun Ray server uses at least two network interfaces: one for the corporate LAN, the other for the Sun Ray interconnect.

Even in a LAN deployment, two server network interfaces are recommended: one to connect to the general LAN and one to connect the server to back-end services, such as file servers, compute grids, and large databases.

## Deployment Examples

There is no physical or logical limit to the ways that a Sun Ray system can be configured. The following sections offer some typical examples.

### Small Deployments

For smaller deployments, such as those with between five and 50 Sun Ray DTUs, the Sun Ray server uses a single 100BASE-T card to connect to a 100BASE-T switch. This switch, in turn, connects to the Sun Ray DTUs. With five or fewer DTUs, a wireless interconnect works acceptably at 10 Mbytes.

For example, in [FIGURE 1-2](#) a Sun Enterprise™ server with a Sun 10/100BASE-T card and a 24-port 10/100BASE-T switch can easily support 23 users performing standard desktop activities.

### Medium to Large Deployments

For larger departments with groups consisting of hundreds or thousands of Sun Ray DTUs, the Sun Ray server uses a gigabit Ethernet card to connect to large 10/100BASE-T switches. Especially with the low-bandwidth enhancements to SRSS, there is no performance need to have more than one gigabit link from the server to the Sun Ray DTU's network.

A 100-user departmental system, for example, consisting of a Sun Enterprise server, one gigabit Ethernet card, and two large (48-port and 80-port) 10/100BASE-T switches delivers services to the 100 Sun Ray DTUs (see [FIGURE 1-4](#)).

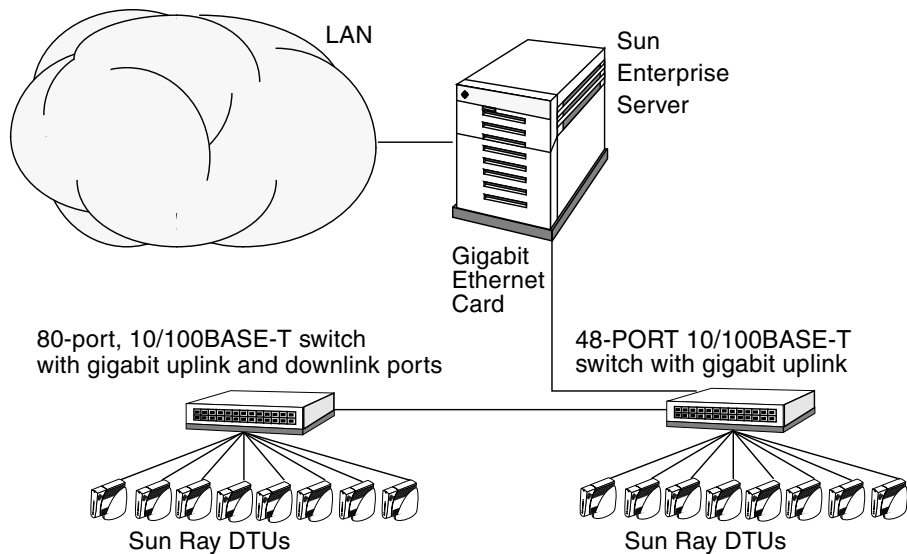

**FIGURE 1-4** Small Deployment Scenario

## Failover Group Scenario

Sun Ray servers can be bound together to create failover groups. A failover group, comprising two or more servers, provides users with a higher level of availability in case one server becomes unavailable due to a network or system failure.

When a server in a failover group goes down, whether for maintenance, a power outage, or any other reason, each Sun Ray DTU connected to it reconnects to another server in the failover group, and to a previously existing session for the current token, if there is one, on that server. If it can find no existing session for the current token, the DTU connects to a server selected by the load balancing algorithm. This server presents a login screen to the user, who then logs in to create a new session. The session on the failed server is lost. Failover groups are discussed in [Chapter 11](#) as well as in the *Sun Ray Server Software 4.0 Installation and Configuration Guide*.

## Regional Hotdesking

Enterprises with multiple failover groups and users who move from one location to another—such as between corporate headquarters and various branch offices—may wish to configure regional hotdesking. This feature provides users with access to their sessions across a wider domain and longer distance than a single failover group.

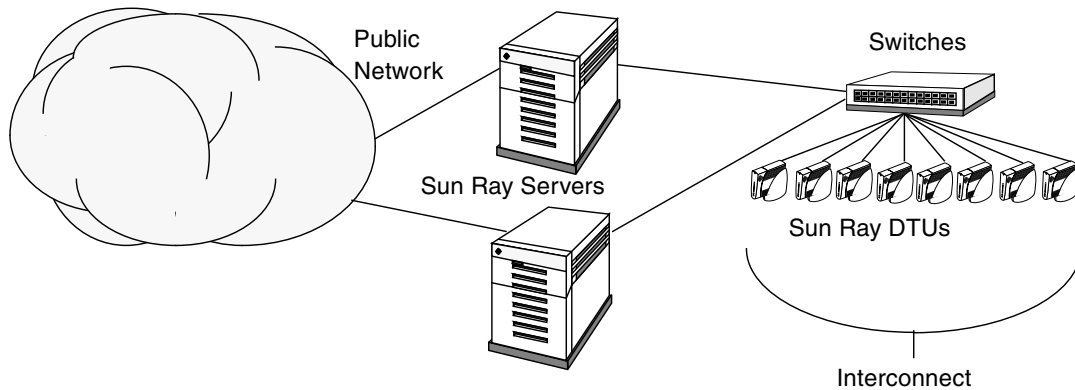

**FIGURE 1-5** Simple Failover Group

---

## Security Considerations

Using switched network gear for the last link to the DTUs makes it difficult for a malicious PC user or network snooper at one of the network ports to obtain unauthorized information. Because switches send packets only to the proper output port, a snooper plugged into another port receives no unauthorized data. If the server and wiring closet are secure, the last step is switched, and the DTU is plugged directly into the wall jack, then it is very difficult to intercept communications between the server and the DTU. SRSS encryption features also help to protect sensitive data by providing the options to encode keyboard input and display traffic.



# Command-Line Interface

---

The Command-Line Interface (CLI) is the recommended interface for enabling assistive technologies.

This chapter contains the following information:

- “Supported Commands” on page 15
- “Session Redirection” on page 20
- “Changing Authentication Policies” on page 23
- “Managing User Data in the Sun Ray Data Store” on page 23
- “Enabling Multiple Administration Accounts” on page 24
- “Enabling and Disabling Device Services” on page 26
- “Configuring Interfaces on the Sun Ray Interconnect Fabric” on page 28
- “Managing Firmware Versions” on page 31
- “Restarting the Sun Ray Data Store (SRDS)” on page 32
- “Smart Card Configuration Files” on page 32
- “Using the `utcapture` Tool” on page 35
- “Examining Log Files” on page 38

---

## Supported Commands

Commands that can be executed from the command line are listed in [TABLE 2-1](#), and a few of the most important commands are documented in this chapter. For further information on executing these commands, see the man page for the command in question.

To view any of the specific commands for the Sun Ray system, type:

```
% man -M /opt/SUNWut/man command
```

or type:

```
% setenv MANPATH=/opt/SUNWut/man  
% man command
```

**TABLE 2-1** Supported Commands

<b>Command</b>	<b>Definition</b>
utaction	The <code>utaction</code> program provides a way to execute commands when a Sun Ray DTU session is connected or disconnected.
utadm	The <code>utadm</code> command manages the private network, shared network, and DHCP (Dynamic Host Configuration Protocol) configuration for the Sun Ray interconnect.
utadminuser	The <code>utadminuser</code> command is used to add, list, and delete UNIX user names from the list of users authorized to administer Sun Ray services. The list is stored in the Sun Ray data store.
utamghadm	The <code>utamghadm</code> command is used to configure or disable regional hotdesking, which enables users to access their sessions across multiple failover groups.
utcapture	The <code>utcapture</code> command connects to the Authentication Manager and monitors packets sent and packets dropped between the Sun Ray server and the Sun Ray DTUs.
utcard	The <code>utcard</code> command allows configuration of different types of smart cards in the Sun Ray data store.
utconfig	The <code>utconfig</code> command performs the initial configuration of the Sun Ray server and supporting administration framework software.
utcrypto	The <code>utcrypto</code> command is a utility for security configuration.
utdesktop	The <code>utdesktop</code> command allows the user to manage Sun Ray DTUs connected to the Sun Ray server that the command is run on.
utdetach	The <code>utdetach</code> command disconnects the current non-smart card mobile session or authenticated smart card session from its respective Sun Ray DTU. The session is not destroyed but put into a detached state. The session can be accessed if the same user token (user name) is presented to the Sun Ray server.

**TABLE 2-1** Supported Commands (*Continued*)

Command	Definition
utdevadm	The <code>utdevadm</code> command is used to enable/disable Sun Ray device services. This includes USB devices connected through USB ports, embedded serial ports, and internal smart card reader in the Sun Ray DTU.
utdiskadm	The <code>utdiskadm</code> utility is a tool for Sun Ray mass storage administration.
utdssync	The <code>utdssync</code> command converts the port number for the Sun Ray Data Store service to the new default port on servers in a failover group, then forces all servers in the group to restart Sun Ray services.
uteject	The <code>uteject</code> command is used to eject media from a removable storage media device.
utfwadm	The <code>utfwadm</code> command manages firmware versions on the Sun Ray DTUs.
utfwload	The <code>utfwload</code> command is used primarily to force the download of new firmware to a DTU running older firmware than its server.
utfwsync	The <code>utfwsync</code> command refreshes the firmware level on the Sun Ray DTUs to what is available on the Sun Ray servers in a failover group. It then forces all the Sun Ray DTUs within the group to restart.
utgroupsig	The <code>utgroupsig</code> command sets the failover group signature for a group of Sun Ray servers. The <code>utgroupsig</code> command also sets the Sun Data Store <code>rootpw</code> used by Sun Ray to a value based on the group signature. Although <code>utgroupsig</code> sets the <code>rootpw</code> in the <code>utdsd.conf</code> file, it does <i>not</i> set the admin password, which is a separate entity, in the data store.
utgstatus	The <code>utgstatus</code> command allows the user to view the failover status information for the local server or for the named server. The information that the command displays is specific to that server at the time the command is run.
utinstall	The <code>utinstall</code> utility installs, upgrades, and removes Sun Ray Server Software. All software required to support the Sun Ray server is installed, including the administration framework, Solaris operating environment patches, and any patches required by the framework.
utkiosk	The <code>utkiosk</code> script is used to import/export kiosk configuration information into the data store.
utmhadm	The <code>utmhadm</code> command provides a way to administer Sun Ray server multihead terminal groups. The information that <code>utmhadm</code> displays and that is editable is stored in the data store.
utmhconfig	The <code>utmhconfig</code> tool allows an administrator to list, add, or delete multiheaded groups easily.
utmout	The <code>utmout</code> command is used to mount a file system on a Sun Ray mass storage device.

**TABLE 2-1** Supported Commands (*Continued*)

<b>Command</b>	<b>Definition</b>
<code>utpolicy</code>	The <code>utpolicy</code> command sets and reports the policy configuration of the Sun Ray Authentication Manager, <code>utauthd(1M)</code> . This command's <code>-i</code> and <code>-t</code> options were deprecated as of the 2.0 release. Continue to use the <code>utpolicy</code> command for policy changes, but use the <code>utrestart</code> command instead of <code>utpolicy -i</code> , and use <code>utreader</code> instead of <code>utpolicy -t</code> .
<code>utpreserve</code>	The <code>utpreserve</code> command saves existing Sun Ray Server Software configuration data to the <code>/var/tmp/SUNWut.upgrade</code> directory.
<code>utpw</code>	The <code>utpw</code> command changes the Sun Ray administrator password (also known as the UT admin password) used by the Web-based and command-line administration applications.
<code>utquery</code>	The <code>utquery</code> command collects DHCP information from the Sun Ray DTUs.
<code>utreader</code>	The <code>utreader</code> command is used to add, remove, and configure token readers.
<code>utreplica</code>	The <code>utreplica</code> command configures the Sun Ray Data Store server to enable replication of administered data from a designated primary server to each secondary server in a failover group. The data stores of the secondary servers remain synchronized automatically unless there is a power outage. The <code>-z</code> option is useful for updating the port number.
<code>utresadm</code>	The <code>utresadm</code> command allows an administrator to control the resolution and refresh rate of the video monitor signal (persistent monitor settings) produced by the Sun Ray unit.
<code>utresdef</code>	The <code>utresdef</code> command lists the monitor resolutions and refresh rates that can be applied to Sun Ray units through the <code>utresadm</code> command.
<code>utrestart</code>	The <code>utrestart</code> command is used to start Sun Ray services. It is highly recommended as a substitute for the old <code>utglpolicy</code> and <code>utpolicy -i</code> commands.
<code>utselect</code>	The <code>utselect</code> command presents the output of <code>utswitch -l</code> as a list of servers in the current host group, to be used for reconnection of the current DTU. A user can either select a server from this list or specify a server not in the current host group by typing its full name in the <code>utselect</code> text box.
<code>utsession</code>	The <code>utsession</code> command lists and manages Sun Ray sessions on the local Sun Ray server.
<code>utset</code>	Use <code>utset</code> to view and change Sun Ray DTU settings.
<code>utsettings</code>	The <code>utsettings</code> command opens a Sun Ray Settings dialog box that allows the user to view or change audio, visual, and tactile settings for the Sun Ray DTU.
<code>utsunmc</code>	The <code>utsunmc</code> command adds the Sun Ray Server Software 4.0 module to the Sun Management Center (SunMC) and loads it to permit monitoring of Sun Ray Server Software. The <code>utsunmc</code> command can also remove the Sun Ray Server Software 4.0 module from SunMC.

**TABLE 2-1** Supported Commands (*Continued*)

<b>Command</b>	<b>Definition</b>
<code>utsunmcinstall</code>	Use <code>utsunmcinstall</code> to install and uninstall the Sun Ray module for SunMC on a SunMC server where Sun Ray Server Software is not installed.
<code>utswitch</code>	The <code>utswitch</code> command allows a Sun Ray DTU to be switched among various Sun Ray servers. <code>utswitch</code> can also list existing sessions for the current token.
<code>utumount</code>	The <code>utumount</code> command is used to unmount a file system from a Sun Ray mass storage device.
<code>utuser</code>	The <code>utuser</code> command allows the administrator to manage Sun Ray users registered on the Sun Ray server that this command is run on. It also provides information on the currently inserted token (smart card) for a specified DTU that is configured as a token reader.
<code>utwall</code>	The <code>utwall</code> utility sends a message or an audio file to users having an Xsun (X server unique to Sun Ray) process. The messages can be sent in email and displayed in a pop-up window.
<code>utwho</code>	The <code>utwho</code> script assembles information about display number, token, logged-in user, etc., in a compact format.
<code>utxconfig</code>	The <code>utxconfig</code> program provides X server configuration parameters for users of Sun Ray DTU sessions.

## ▼ To Stop Sun Ray Services

- Type:

```
# /etc/init.d/utsvc stop
```

## ▼ To Start Sun Ray Services

- Type:

```
# /opt/SUNWut/sbin/utrestart
```

This procedure, known as a *warm restart*, starts Sun Ray services without clearing existing sessions.

Or

- Type:

```
# /opt/SUNWut/sbin/utrestart -c
```

This procedure, known as a *cold restart*, starts Sun Ray services and clears existing sessions.

---

## Session Redirection

After a user's token has been authenticated, whether via smart card token or direct login, it is automatically redirected to the appropriate server. To redirect a session to a different server manually, use the `utselect` graphical user interface (GUI) or the `utswitch` command.

## ▼ To Redirect to a Different Server

- From a shell window on the DTU, type:

```
% /opt/SUNWut/bin/utselect
```

The selections in the window are sorted in order of the most current to least current active sessions for the token ID.

In [FIGURE 2-1](#), the Server column lists the servers accessible from the DTU. The Session column reports the `DISPLAY` variable X session number on the server if one exists. In the Status column, Up indicates that the server is available. The first server in the list is highlighted by default. Select a server from the list or enter the name of a server in the Enter server: field. If a server without an existing session is selected, a new session is created on that server.

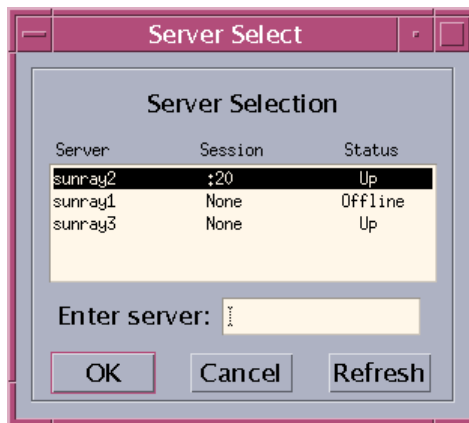

**FIGURE 2-1** The Server Selection (`utselect`) GUI

The OK button commits the selection of the highlighted or manually entered server. The Cancel button dismisses the GUI without making any changes to the session. The Refresh button reloads the window with the most current information.

---

**Note** – If only one server in the failover group is up, it is displayed in the `utselect` GUI. However, if `selectAtLogin` is set to `true` in the `/etc/opt/SUNWut/auth.props` file, the GUI is not displayed because there appears to be only one server in the failover group.

---

## ▼ To Redirect a DTU Manually

- From a shell window on the DTU, type:

```
% /opt/SUNWut/bin/utswitch -h host [ -k token]
```

where *host* is the host name or IP address of the Sun Ray server to which the selected DTU is redirected, and *token* is the user's token ID.

## ▼ To List Available Hosts

- From a shell window, type:

```
% /opt/SUNWut/bin/utswitch -l
```

Hosts available from the Sun Ray DTU are listed.

## ▼ To Select a Server with the Latest Session

- In a shell window, type:

```
% /opt/SUNWut/bin/utswitch -t
```

The DTU is redirected to the server with the latest session connect time.



---

# Managing User Data in the Sun Ray Data Store

You can specify the following user fields in the Sun Ray data store:

**TABLE 2-2** Key User Fields

Field	Description
Token ID	User's unique token type and ID. For smart cards, this is a manufacturer type and the card's serial ID. For DTUs, this is the type "pseudo" and the DTU's Ethernet address. Examples: mondex.9998007668077709 pseudo.080020861234
Server Name	Name of the Sun Ray server that the user is using.
Server Port	Sun Ray server's communication port. This field should generally be set to 7007.
User Name	User's name.
Other Info	Any additional information you want to associate with the user (for example, an employee or department number). This field is optional.

---

**Note** – Sun Ray Server Software now supports multiple administration accounts. This feature is described in [“Enabling Multiple Administration Accounts” on page 24](#).

---

---

## Changing Authentication Policies

When you set an authentication policy with `utpolicy`, the failover group policy is set automatically, so all that is needed at that point is to reset or restart services. The Admin GUI's System Policy tab refers to authentication policy.

---

**Tip** – Use the `utrestart -c` command instead of rebooting the server.

---

**TABLE 2-3** utrestart Commands

Command/Option	Result
<code>/opt/SUNWut/sbin/utrestart</code>	Use this option if a minor policy change was made, such as adding a dedicated token reader. With such minor changes, it is not necessary to terminate existing sessions. This is a warm restart.
<code>/opt/SUNWut/sbin/utrestart -c</code>	Use this option if a significant policy change has been made, such as enabling or disabling access to mass storage devices. All existing sessions are terminated. This is a cold restart.

## Enabling Multiple Administration Accounts

Early releases of Sun Ray Server Software allowed only one user account, admin, to modify entries in the Sun Ray Data Store. Now, however, the administrator can allow any valid UNIX user ID in the authorized user list to administer Sun Ray services. An audit trail of activity on these accounts is provided. See the man page for `utadminuser(1M)`.

Authentication for accounts with administrative privileges is based on the PAM authentication framework.

### PAM Entries

In order to support the old Data Store authentication, a PAM module, `/opt/SUNWut/lib/pam_sunray_admingui.so.1`, is included in the Sun Ray product.

`utconfig(1M)` adds the following PAM entry for Sun Ray Admin GUI configuration:

- On Solaris (`/etc/pam.conf`):

```
utadmingui auth sufficient /opt/SUNWut/lib/pam_sunray_admingui.so.1
```

## ▼ To Configure UNIX Users

To configure the Sun Ray Admin GUI to use UNIX user names instead of the default admin account:

- **Modify the `/etc/pam.conf` file to use the `dtlogin` authentication PAM stack auth entries to create the PAM stack for `utadmingui`.**

```
# added to utadmingui by Sun Ray Server Software -- utadmingui
utadmingui auth requisite pam_authtok_get.so.1
utadmingui auth required pam_dhkeys.so.1
utadmingui auth required pam_unix_auth.so.1
```

---

**Note** – Make sure to include the comment line, which is needed for the cleanup to work properly.

---

## ▼ To Revert to the Old admin User

To return to the old Sun Ray Admin GUI authentication scheme:

- **Modify the `/etc/pam.conf` file and replace the PAM stack for `utadmingui` with the `pam_sunray_admingui.so.1` module:**

```
# added to utadmingui by Sun Ray Server Software -- utadmingui
utadmingui auth sufficient /opt/SUNWut/lib/pam_sunray_admingui.so.1
```

---

**Note** – Make sure to include the comment line, which is needed for the cleanup to work properly.

---

## Administration GUI Audit Trail

The administration framework provides an audit trail of the Administration GUI. The audit trail is an audit log of the activities performed by multiple administration accounts. All events that modify system settings are logged in the audit trail.

SRSS 4.0 uses the `syslog` implementation. Events are logged into `/var/opt/SUNWut/log/messages` file, where audit events are prefixed with the keyword `utadt::` so that administrator can filter events from the messages file.

For example, session termination from the Admin GUI generates the following audit event:

```
Jun  6 18:49:51 sunrayserver usersession[17421]: [ID 521130 user.info] utadt::
username={demo} hostname={sunrayserver} service={Sessions}
cmd={/opt/SUNWut/lib/utrcmd sunrayserver /opt/SUNWut/sbin/utsession -x -d 4 -t
Cyberflex_Access_FullCrypto.1047750b1e0e -k 2>&l}
message={terminated User "Cyberflex_Access_FullCrypto.1047750b1e0e" with
display number="4" on "sunrayserver"}
status={0} return_val={0}
```

where

<i>username</i>	=	User's Unix ID
<i>hostname</i>	=	Host on which the command is executed
<i>service</i>	=	Name of the service being executed
<i>cmd</i>	=	Name of the command being executed
<i>message</i>	=	Details about the action being performed

---

## Enabling and Disabling Device Services

Sun Ray device services can be enabled/disabled with the `utdevadm` command line tool or with the Admin GUI. Sun Ray device services include USB devices connected through USB ports, internal serial ports, and internal smart card readers on the Sun Ray DTU. Device services can also be administered from the Security tab on the Admin GUI's Advanced tab.

When internal serial service is disabled, users cannot access embedded serial ports on the Sun Ray DTU. The Sun Ray 170 has two embedded serial ports.

When internal smart card reader service is disabled, users cannot access the internal smart card reader through the PC/SC or SCF interfaces for reading or writing; however, this does not affect session access or hotdesking with unauthenticated smart cards.

When USB service is disabled, users cannot access any devices connected to USB ports. This does not, however, affect HID devices such as the keyboard, mouse, or barcode reader.

After installation of Sun Ray Server Software, all device services are enabled by default. You can use the `utdevadm` command to enable or disable device services only in the configured mode, that is, *after* the Sun Ray Data store is activated.

This configuration affects all the servers in a group and all the DTUs connected to that group.

The following example shows how to enable/disable USB service. The other device services can be enabled or disabled with the same syntax.

## ▼ To Determine the Current State of Device Services

- Use the `utdevadm` command:

```
# /opt/SUNWut/sbin/utdevadm
```

This displays enabled or disabled state of the devices.

## ▼ To Enable USB Service

- Use the `utdevadm` command as below:

```
# /opt/SUNWut/sbin/utdevadm -e -s usb
```

## ▼ To Disable USB Service

- Use the `utdevadm` command as below:

```
# /opt/SUNWut/sbin/utdevadm -d -s usb
```

## ▼ To Perform a Cold Restart

- Use the `utrestart` command as below:

```
# /opt/SUNWut/sbin/utrestart -c
```

---

## Configuring Interfaces on the Sun Ray Interconnect Fabric

Use the `utadm` command to manage the Sun Ray interconnect fabric.

---

**Note** – If the IP addresses and DHCP configuration data are not set up properly when the interfaces are configured, then the failover feature will not work as expected. In particular, configuring the Sun Ray server’s interconnect IP address as a duplicate of any other server’s interconnect IP address may cause the Sun Ray Authentication Manager to generate “Out of Memory” errors.

---

---

**Note** – If you make manual changes to your DHCP configuration, you will have to make them again whenever you run `utadm` or `utfwadm`.

---

---

**Tip** – If you issue a <CTRL>C signal while performing `utadm` configuration, `utadm` may not function correctly the next time it is invoked. To correct this condition, type: `dhtadm -R`.

---

## ▼ To Add an Interface

- Type:

```
# /opt/SUNWut/sbin/utadm -a interface_name
```

This command configures the network interface *interface\_name* as a Sun Ray interconnect. Specify a subnet address or use the default address, which is selected from reserved private subnet numbers between 192.168.128.0 and 192.168.254.0.

---

**Note** – If you choose to specify your own subnet, make sure it is not already in use.

---

After an interconnect is selected, appropriate entries are made in the `hosts`, `networks`, and `netmasks` files. (These files are created if they do not exist.) The interface is activated.

Any valid Solaris network interface can be used. For example:

```
hme[0-9], qfe[0-3]
```

## ▼ To Delete an Interface

- Type:

```
# /opt/SUNWut/sbin/utadm -d interface_name
```

This command deletes the entries that were made in the `hosts`, `networks`, and `netmasks` files and deactivates the interface as a Sun Ray interconnect.

## ▼ To Print the Sun Ray Private Interconnect Configuration

- Type:

```
# /opt/SUNWut/sbin/utadm -p
```

For each interface, this command displays the hostname, network, netmask, and number of IP addresses assigned to Sun Ray DTUs by DHCP.

---

**Note** – Sun Ray servers require static IP addresses; therefore, they cannot be DHCP clients.

---

## ▼ To Add a LAN Subnet

- Type:

```
# /opt/SUNWut/sbin/utadm -A subnet_number
```

## ▼ To Delete a LAN Subnet

- Type:

```
# /opt/SUNWut/sbin/utadm -D subnet_number
```

## ▼ To Print Public LAN Subnets

- Type:

```
# /opt/SUNWut/sbin/utadm -l
```

## ▼ To Remove All Interfaces and Subnets

Use the `utadm -r` command to prepare for removal of the Sun Ray Server Software.

- Type:

```
# /opt/SUNWut/sbin/utadm -r
```

This command removes all of the entries and structures relating to all of the Sun Ray interfaces and subnets.



---

# Managing Firmware Versions

Use the `utfwadm` command to keep the firmware version in the PROM on Sun Ray DTUs synchronized with that on the server. See also [“Firmware Download” on page 112](#).

---

**Note** – If the DHCP *version* variable is defined, then when a new DTU is plugged in, its firmware is changed to the firmware version on the server.

---

---

**Note** – If you make manual changes to your DHCP configuration, you will have to make them again whenever you run `utadm` or `utfwadm`.

---

## ▼ To Update All the DTUs on an Interface

- Type:

```
# /opt/SUNWut/sbin/utfwadm -A -a -n interface
```

---

**Tip** – To force a firmware upgrade, power-cycle the DTUs.

---

## ▼ To Update a DTU Using the Ethernet (MAC) Address

- Type:

```
# /opt/SUNWut/sbin/utfwadm -A -e MAC_address -n interface
```

---

# Restarting the Sun Ray Data Store (SRDS)

If you restart the Sun Ray Data Store daemon (`utdsd`), you must also restart the Sun Ray Authentication Manager. The Sun Ray Data Store daemon may need to be restarted if you change one of its configuration parameters. The following procedure shows the correct order of the steps to take if you need to restart SRDS.

## ▼ To Restart Sun Ray Data Store

1. Stop the Sun Ray services:

```
# /etc/init.d/utsvc stop
```

2. Stop the Sun Ray Data Store daemon:

```
# /etc/init.d/utds stop
```

3. Restart the Sun Ray services:

```
# /opt/SUNWut/sbin/utrestart
```

---

# Smart Card Configuration Files

Use the Administration Tool or the `utcard` command to add additional smart card vendor configuration files.

Smart card configuration files are available from a variety of sources, including Sun and various of smart card manufacturers. For more ample information on smart cards, see the latest version of the *Solaris Smart Card Administration Guide*.

## ▼ To Load a Configuration File Into the Directory

- Copy the vendor configuration file containing the vendor tags to the following location:

```
# cp vendor.cfg /etc/opt/SUNWut/smartcard
```

The additional vendor cards are displayed under the Available Smart Cards column in the Card Probe Order tab in the Administration Tool.

---

## Configuring and Using Token Readers

Some manufacturers print the smart card ID on the card itself, but many do not. Since all the administrative functions refer to this token ID, Sun Ray Server Software provides a way to designate one or more specific DTUs as dedicated token readers. Site administrators can use a dedicated token reader to administer Sun Ray users through their tokens. A token reader is not used for normal Sun Ray services, so it does not need a keyboard, mouse, or monitor.

---

**Note** – When you enable an authentication policy with registered users, or token owners, be sure to specify smart card IDs for the appropriate token owners.

---

In the example configuration in [FIGURE 2-2](#), the second DTU acts as a token reader.

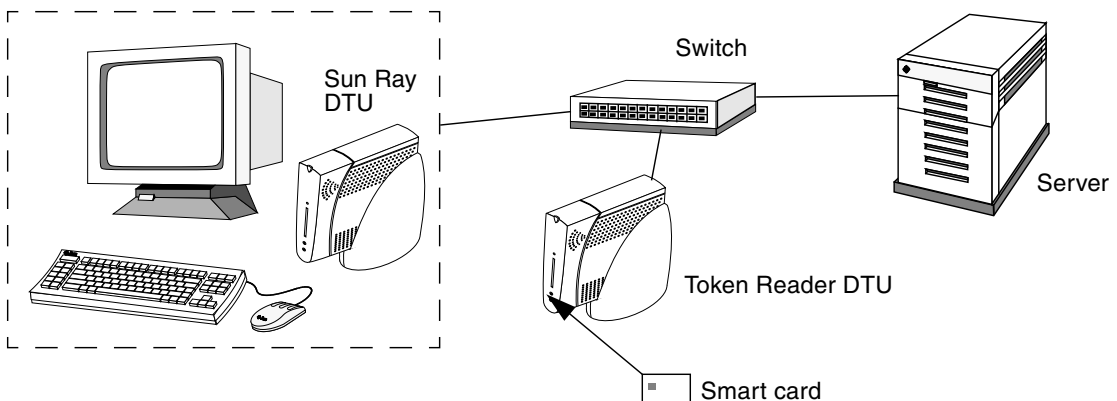

**FIGURE 2-2** Using a Token Reader to Register Smart Cards

## ▼ To Configure a Token Reader

The `utreader` command specifies a DTU for registering smart cards. When a DTU is configured as a token reader, inserting or removing a smart card does not cause session mobility to occur; instead, any session connected to the DTU remains connected to that DTU over a card movement event.

Token reader mode is useful when you want to determine the raw token ID of a smart card. For example, to configure the DTU with MAC address `0800204c121c` as a token reader, issue the following `utreader` command:

```
# /opt/SUNWut/sbin/utreader -a 0800204c121c
```

To re-enable the DTU with MAC address `0800204c121c` to recognize card movement events and perform session mobility based on the smart card inserted into the DTU:

```
# /opt/SUNWut/sbin/utreader -d 0800204c121c
```

To unconfigure all token readers on this server:

```
# /opt/SUNWut/sbin/utreader -c
```

## ▼ To Get a Token ID From a Token Reader

In releases prior to SRSS 3, access to the token card reader was limited to the server to which it was connected; the `utuser` command had to be invoked from that server. Beginning with SRSS 3.1, however, you can access the token card reader by invoking `utuser -r` from any server in the relevant failover group. The procedure otherwise remains as it was in earlier releases.

- Type the following command:

```
# /opt/SUNWut/sbin/utuser -r Token Reader
```

where *Token Reader* is the MAC address of the DTU containing the smart card whose ID you want to read. Insert the smart card into the DTU and run the `utuser` command. This command queries the DTU for the smart card token's ID and, if successful, displays it. For example:

```
# /opt/SUNWut/sbin/utuser -r 08002086e18f
Insert token into token reader '08002086e18f' and press return.
Read token ID 'mondex.9998007668077709'
```

---

## Using the `utcapture` Tool

The `utcapture` tool connects to the Authentication Manager and collects data about the packets sent and packets dropped between the Sun Ray server and the DTU. The data in [TABLE 2-4](#) is then displayed on the screen in the following format:

**TABLE 2-4** Data Elements Displayed

Data Element	Description
TERMINALID	The MAC address of the DTU
TIMESTAMP	The time the loss occurred in year-month-day-hour-minute-second format. Example: 20041229112512
TOTAL PACKET	Total number of packets sent from server to DTU
TOTAL LOSS	Total number of packets reported as lost by DTU
BYTES SENT	Total number of bytes sent from server to DTU
PERCENT LOSS	Percentage of packets lost between the current and previous polling interval
LATENCY	Time in milliseconds for a round trip from DTU to server.

---

**Tip** – If Sun Ray DTU traffic loss is more than .1%, allocate higher priority to the VLAN that carries Sun Ray DTU traffic. For more information on how to change the priority, please refer to the manufacturer's documentation for your switch.

---

The following `utcapture` options are supported:

**TABLE 2-5** `utcapture` Options

Option	Definition
<code>-h</code>	Help for using the command.
<code>-r</code>	Dump output to <code>stdout</code> in raw format. By default, data is dumped when there is a packet loss. With this option, the data is always dumped to <code>stdout</code> .
<code>-s server</code>	Name of server on which the Authentication Manager is running. By default, it is the same host that is running <code>utcapture</code> .
<code>-i filename</code>	Process raw data from a file specified by file name and dump to <code>stdout</code> only the data for those DTUs that had packet loss.
<code>desktopID</code>	Collects the data for the specified DTUs only. DTUs are specified on the command line by their desktop IDs separated by a space. By default, data for all currently active desktops is collected.

## ▼ To Start `utcapture`

From a command line, enter one of the following commands:

```
% /opt/SUNWut/sbin/utcapture -h
```

This command lists the help commands for the `utcapture` tool.

```
% /opt/SUNWut/sbin/utcapture
```

This command captures data every 15 seconds from the Authentication Manager running on the local host and then writes it to `stdout` if there is any change in packet loss for a DTU.

```
% /opt/SUNWut/sbin/utcapture -r > raw.out
```

This command captures data every 15 seconds from the Authentication Manager running on the local host and then writes it to `stdout`.

```
% /opt/SUNWut/sbin/utcapture -s sunray_server5118.eng \  
080020a893cb 080020b34231
```

This command captures data every 15 seconds from the Authentication Manager running on `server5118.eng` and then writes the output to `stdout` if there is any change in packet loss for the DTU with ID `080020a893cb` or `080020b34231`.

```
% /opt/SUNWut/sbin/utcapture -i raw-out.txt
```

This command processes the raw data from the input file `raw-out.txt` and then writes to `stdout` the data only for those DTUs that had packet loss.

---

# Examining Log Files

Significant activity concerning files retrieved from the Sun Ray server is logged and saved. The server stores this information in text files. [TABLE 2-6](#) describes the log files that are maintained.

**TABLE 2-6** Log Files

Log File	Path	Description
Administration	<code>/var/opt/SUNWut/log/admin_log</code>	Lists operations performed during server administration. This log is updated daily. Archived files are stored on the system for up to one week and are annotated using numeric extensions (for example, from file name <code>admin_log.0</code> to <code>admin_log.5</code> ).
Authentication	<code>/var/opt/SUNWut/log/auth_log</code>	Lists events logged from the Authentication Manager. The <code>auth_log</code> file is updated (up to a limit of 10) every time the server's authentication policy is changed or started. The archived authentication files are annotated using numeric extensions (for example, from <code>auth_log.0</code> to <code>auth_log.9</code> ).
Automatic Mounting	<code>/var/opt/SUNWut/log/utmountd.log</code>	Lists mount messages for mass storage devices. The archived <code>mountd</code> files are annotated using numeric extensions (for example, from <code>utmountd.log.0</code> to <code>utmountd.log.9</code> ).
Mass Storage Devices	<code>/var/opt/SUNWut/log/utstoraged.log</code>	Lists mass storage device events. The archived storage files are annotated using numeric extensions (for example, from <code>utstoraged.log.0</code> to <code>utstoraged.log.9</code> ).
Messages	<code>/var/opt/SUNWut/log/messages</code>	Lists events from the server's DTUs, including details of registering, inserting, or removing smart cards. This file is updated daily. Archived files are stored on the server for one week annotated with numeric extensions (for example, from <code>messages.0</code> to <code>messages.5</code> ).



# Administration Tool

---

The Sun Ray Administration Tool (Admin GUI) is organized, as of the 4.0 release, around primary Sun Ray objects, such as servers, sessions, desktop units, and tokens. The tab navigation model is easier to use than the previous navigation tree, and context-sensitive help makes it easier to manage a Sun Ray installation with little need for official documentation. Search functionality has been integrated into the main GUI tabs, and all tables can be sorted by clicking on the column headers.

The navigation hierarchy is organized as follows:

- [Servers Tab](#)
  - Server Details
    - View Installed Sun Ray Packages
    - View Network Status
    - View Connected Desktop Units
    - View Session Details
- [Sessions Tab](#)
- [Desktop Units Tab](#)
  - Desktop Unit Properties
    - Edit Desktop Unit Properties
- [Tokens Tab](#)
  - Registered Tokens
  - Currently Used Tokens
  - Add New Token
  - Token Properties
    - Edit Token Properties
- [Advanced Tab](#)
  - Security
  - System Policy
  - Kiosk Mode
    - Display Kiosk Mode details
    - Edit Kiosk Mode (specify session type and properties)
  - Card Probe Order
    - Edit Card Probe Order
  - Data Store Password
- [Log Files Tab](#)

---

# Login Page

The default user name for the Admin GUI administration account is `admin`. The initial password is set at configuration time (see [“Configure Sun Ray Server Software” on page 45](#) of the *Sun Ray Server Software 4.0 Installation and Configuration Guide for Solaris*).

To allow another user account or accounts to perform administrative functions, see [“Enabling Multiple Administration Accounts” on page 24](#) of this manual.

To access the Admin GUI, log in to your Sun Ray server’s console or to any DTU attached to it, start a browser, and type the following URL:

```
http://localhost:1660
```

---

**Note** – If you chose a different port number when you configured the Sun Ray Server Software, substitute that number for 1660 in the URL above. If secure communication was enabled during SRSS configuration, the browser may be redirected to a secure port (default 1661).

---

If you get a message denying access, make sure that:

- You are running a browser on a Sun Ray server or one of its DTUs.
- The browser is not using a different machine as an HTTP proxy server (to proxy the connection to the HTTP server (Web server)).

All actions performed within the Admin GUI that modify system settings are logged in an audit trail.

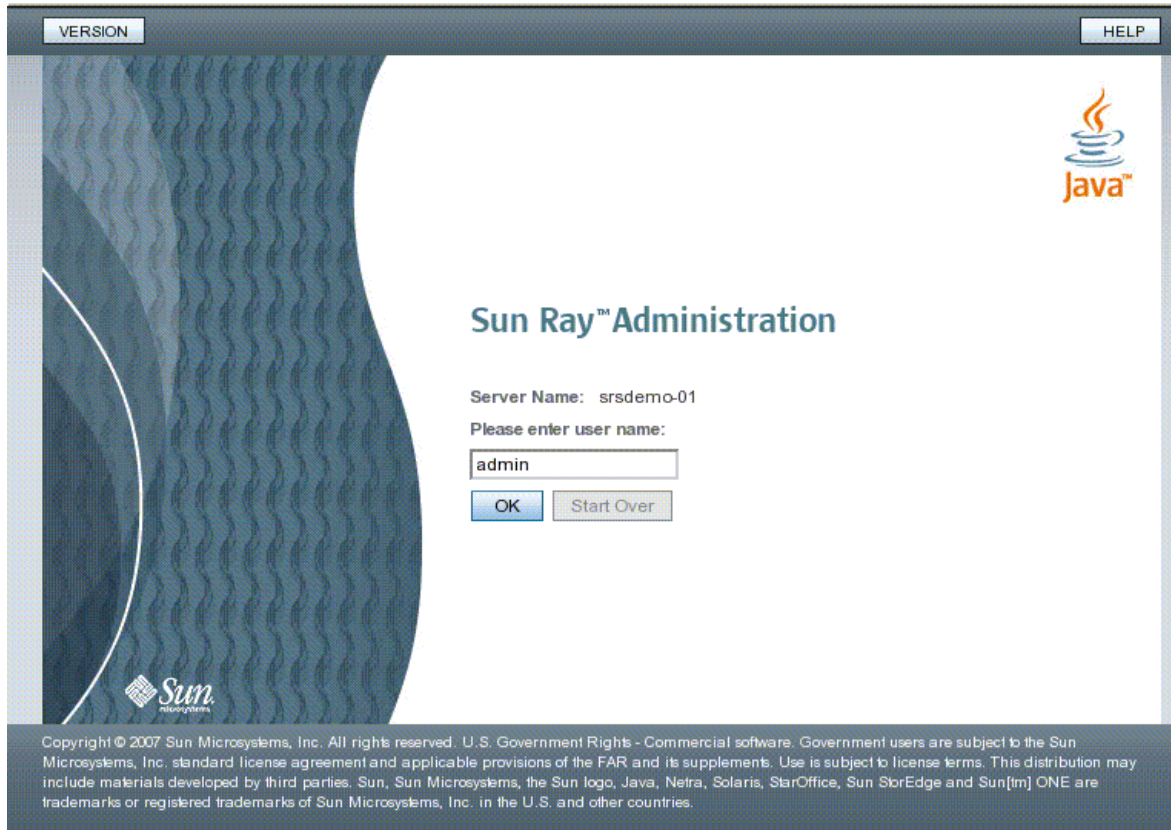

**FIGURE 3-1** User Name Challenge Screen

To log in, enter the administrator user name `admin` on the user name challenge screen and click the OK button. On the password challenge screen, enter the administration password and click the OK button.

If the session is inactive for 30 minutes, you must log in again.

---

**Note** – To change the administration password, use the Advanced tab. See [“Data Store Password”](#) on page 53.

---

# Servers Tab

This tab provides the capability to list all the servers in the *failover group*. Clicking on a server name displays additional details for the selected server and offers links to display the host group's network connectivity status (that is, failover group status) or to list installed Sun Ray packages. It also simplifies restart options by offering buttons for *warm restart* or *cold restart* of Sun Ray services on a local or failover group-wide basis.

---

**Note** – A cold restart terminates all sessions on the selected server or servers before restarting; a warm restart does not terminate sessions.

---

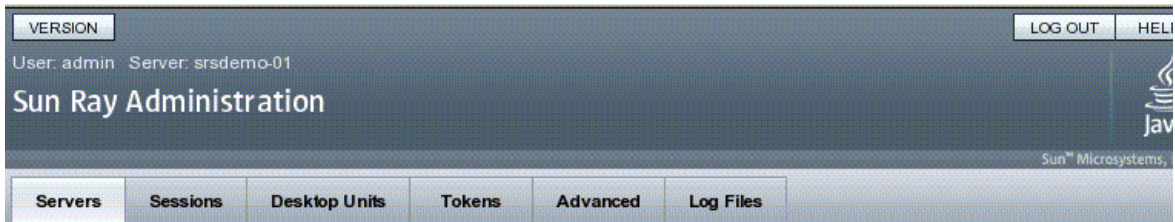

## Servers

This page lists all Sun Ray servers currently in the failover group. Click on the server names to display additional details.

The screenshot shows a table titled 'Servers (2)'. Above the table are two buttons: 'Warm Restart' and 'Cold Restart', and a close button. The table has the following columns: Name, IP Address, Type, Mode, LAN Connections, and Start Time. There are two rows of data.

	Name	IP Address	Type	Mode	LAN Connections	Start Time
<input type="checkbox"/>	srsdemo-01	10.6.133.148	Primary	Online	Disabled	Mon Mar 19 17:05:18 PDT 2007
<input type="checkbox"/>	srsdemo-02	10.6.133.171	Secondary	Online	Disabled	Mon Mar 19 17:04:49 PDT 2007

FIGURE 3-2 Top-level Servers Tab

# Sessions Tab

This tab lists all the sessions, sorted by *user sessions* and *idle sessions*.

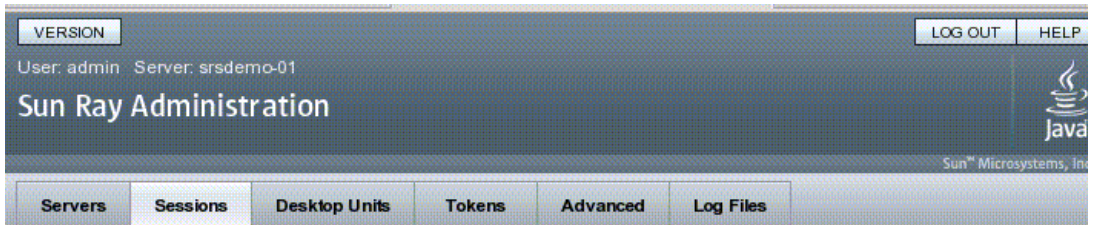

## Sessions

This page lists all sessions within the failover group. Use the search functionality to look for sessions on specific servers.

Search functionality:

### Sessions (4)

	Token	Owner	Unix ID	Server	Display	Status	Desktop Unit
<b>User Sessions</b>							
No user sessions found.							
<b>Login Greeter/Idle Sessions</b>							
<input type="checkbox"/>	Cryptoflex_4K.00000ecc01000000			srsdemo-02	2	Connected	0003ba0d91ba
<input type="checkbox"/>	Payflex.500598e400130100			srsdemo-02	3	Connected	0003ba0d9157
<input type="checkbox"/>	pseudo.0003ba0d9114			srsdemo-02	5	Connected	0003ba0d9114
<input type="checkbox"/>	pseudo.0003ba2fe36a			srsdemo-02	4	Connected	0003ba2fe36a

**FIGURE 3-3** Sessions Tab Displays Active and Idle Sessions

The search functionality allows lookup of specific sessions, such as those running on a single server or sessions where a specific user is logged in. This tab also allows you to drill down for more information on any server or DTU as well as to select and terminate sessions.

# Desktop Units Tab

The new desktop unit (DTU) management tab consolidates several DTU-related screens from the old Admin GUI.

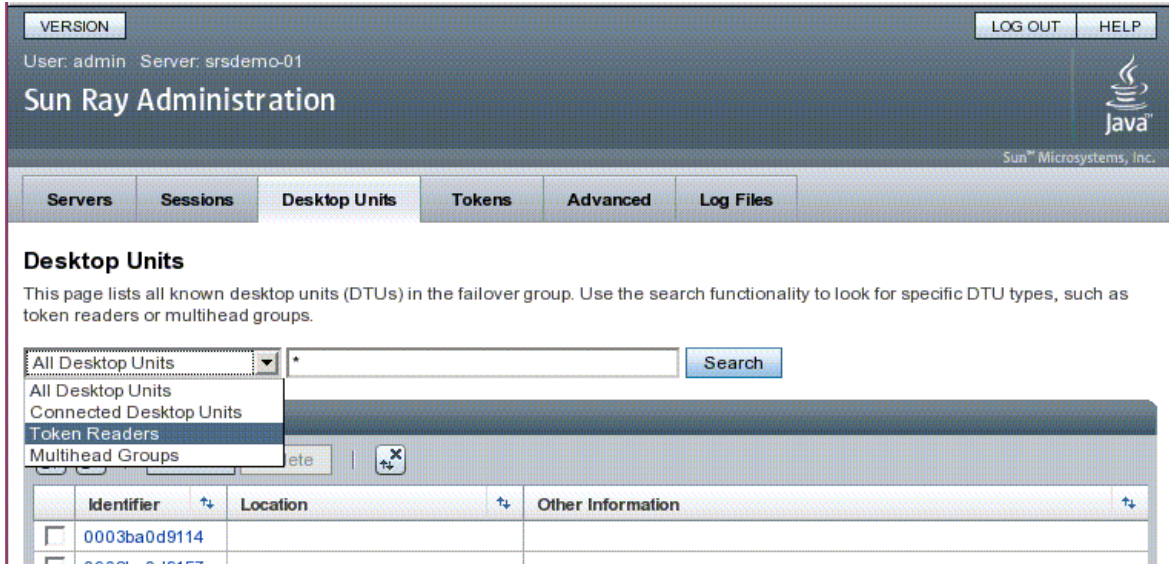

FIGURE 3-4 Desktop Units Tab

The search drop-down menu provides access to the choices of listing all registered DTUs, listing all connected DTUs, displaying DTUs configured as token readers, or DTUs participating in multihead groups (see [“Multihead Groups” on page 142](#)). As on other tabs in the new Admin GUI, clicking on the identifier (MAC address) displays additional details for each DTU. All fields can be sorted by clicking their column headers.

## ▼ To Display Properties for a DTU

- Click any Desktop Identifier link on the Desktop Units tab.

## ▼ To Edit a DTU’s Properties

1. Click any Desktop Identifier link on the Desktop Units tab, then click the Edit button.
2. Enter or modify data in the text boxes, and click the OK button to save the changes to the data store.

# Multihead Groups

The multihead feature allows users to control separate applications on multiple Sun Ray displays with a single keyboard and mouse, attached to the primary DTU. The multihead feature also allows users to display and control a single application, such as a spreadsheet, on multiple displays (see [Chapter 9](#)).

## Token Readers

A token reader is a Sun Ray DTU that is dedicated to reading a smart card and returning the card's ID, which you can associate with a user (card owner). Sun Ray DTUs configured as token readers display the token reader icon (see [“Token Reader Icons” on page 212](#)) instead of a login dialog box and do not support hotdesking when cards are inserted or removed. To manage token readers with the CLI, see [“Configuring and Using Token Readers” on page 33](#).

### ▼ To Set Up a Token Reader

1. **On the Desktop Units tab, click the Identifier of the DTU you want to use as a token reader.**
2. **On the Desktop Unit Properties tab, click Edit.**
3. **On the Edit Desktop Unit Properties tab, click the Token Reader checkbox.**
4. **Click the OK button.**

The DTU you have selected is now set up to read smart card tokens.

5. **Restart Sun Ray services.**

The DTU is now a token reader.

### ▼ To Locate a Token Reader

- **On the Desktop Units tab, select Token Readers from the drop-down list and click the Search button.**

The default is to search for all possible matches. You may specify other search criteria in the Search text box.

### ▼ To Get Information on a Token Reader

- **Click the Token Readers Identifier link after searching for token readers on the Desktop Units tab.**



# Tokens Tab

The Admin GUI manages *tokens* associated with users.

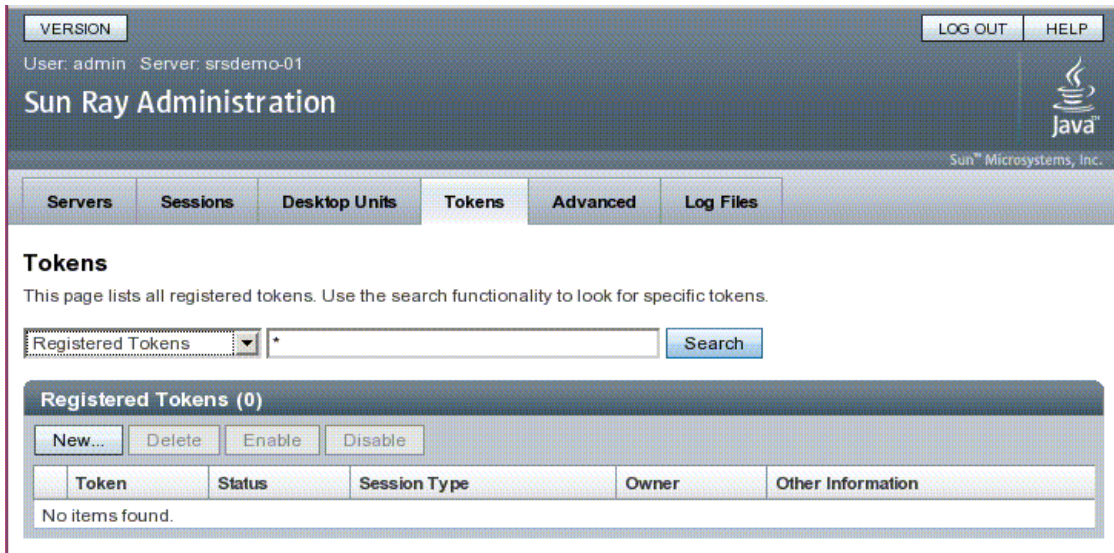

**FIGURE 3-5** Tokens Tab

For example, smart cards can be registered to specific users, considered as *token owners*.

The Tokens tab also provides check boxes to enable session types, such as Kiosk or regular desktop sessions, to control what type of desktop is displayed for each user token or class of user token.

---

**Note** – The Tokens tab is not used to administer token readers. See [“Token Readers” on page 45](#).

---

## ▼ To Register a Token

1. Click on any token on the Tokens tab to display that token’s Token Properties page.
2. To register a token, press the New button to display.

The New Alias Token screen allows you to enter an identifier or select a token reader.



▼ **To Enable, Disable, or Delete a Token**

1. **Click the check box next to the token's identifier on the Token Properties page.**
2. **Click the Enable, Disable, or Delete button.**

# Advanced Tab

This tab provides sub-tabs for group-wide settings, described below.

## Security Settings

Security settings include encryption of communication between DTU and server, server authentication, security mode, and device access, as shown in [FIGURE 3-6](#).

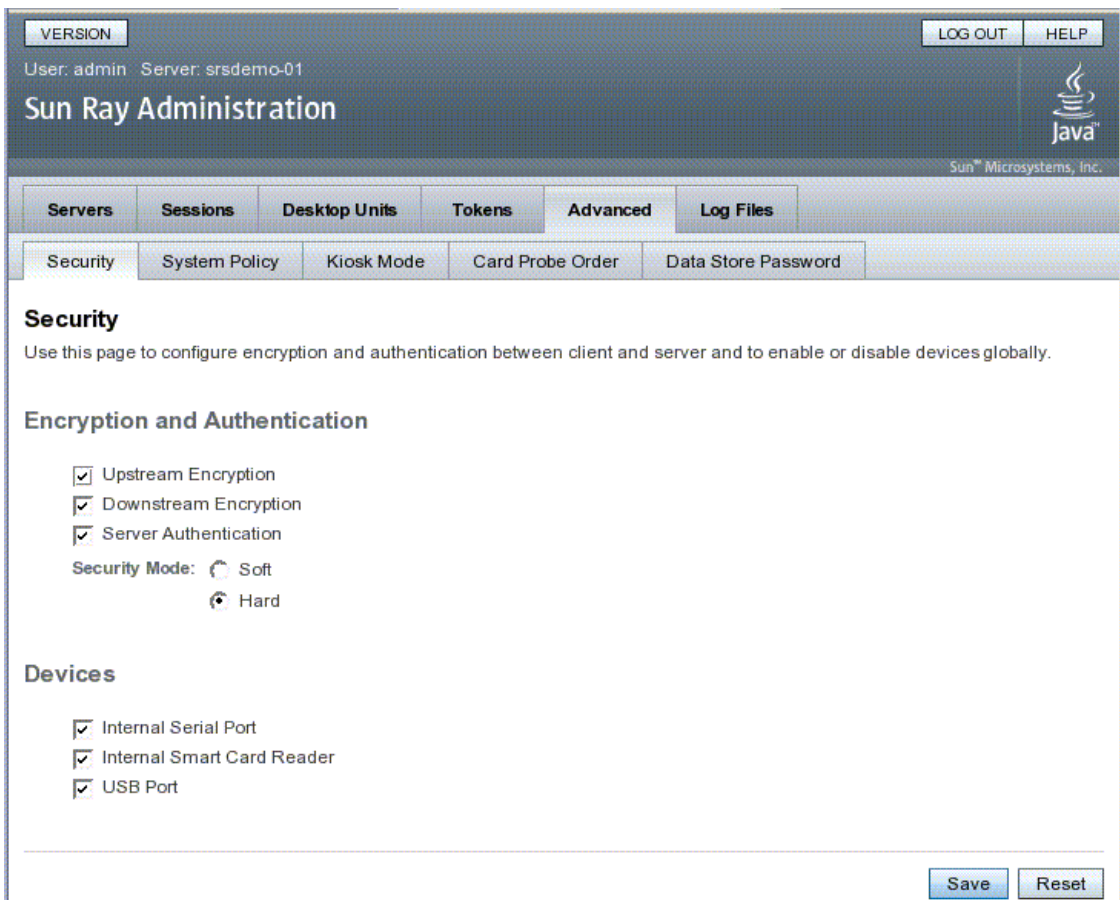

FIGURE 3-6 The Security Tab

All Sun Ray device services are enabled by default. Sun Ray device services include USB devices connected through USB ports, internal serial ports, and internal smart card readers on the Sun Ray DTU. To enable or disable these services, use the `utdevadm` command line tool (see [“Enabling and Disabling Device Services” on page 26](#)) or the Admin GUI as shown in this section.

For a description of encryption and authentication options, see [“Encryption and Authentication” on page 81](#). For devices, see [“Peripherals for Sun Ray DTUs” on page 55](#).

# System Policy

Use this tab to regulate authentication manager policy settings, such as access for card users and non-card users, and enabling Kiosk mode and the multihead feature, for each Sun Ray server, or system.

VERSION LOG OUT HELP

User: admin Server: srsdemo-01

## Sun Ray Administration

Sun Microsystems, Inc.

Servers Sessions Desktop Units Tokens Advanced Log Files

Security System Policy Kiosk Mode Card Probe Order Data Store Password

### Policy

This page allows you to configure group-wide policies.

Save Reset

#### Card Users

Access:  None  
 All Users  
 Users with Registered Tokens  
 Self Registration Allowed  
 User Account Authentication Required

Kiosk Mode:  Enabled

---

#### Non-Card Users

Access:  None  
 All Users  
 Users with Registered Tokens  
 Self Registration Allowed  
 User Account Authentication Required

Kiosk Mode:  Enabled

Mobile Sessions:  Enabled  
 Exit from Mobile Sessions Allowed

---

#### Multihead

Multihead Feature:  Enabled

Save Reset

FIGURE 3-7 System Policy Tab

# Kiosk Mode Configuration

To use Kiosk Mode, enable it on the System Policy tab (see [FIGURE 3-7](#)) and use the Kiosk Mode tab for setup. For a more detailed description, see [“Kiosk Mode” on page 151](#) of this manual and [“Migrating from Controlled Access Mode \(CAM\) to Kiosk Mode” on page 53](#) of the *Sun Ray Server Software 4.0 Installation and Configuration Guide for Solaris*.

The screenshot shows the Sun Ray Administration web interface. At the top, there is a header with 'VERSION', 'LOG OUT', and 'HELP' buttons. Below the header, the user is identified as 'admin' on server 'srstdemo-01'. The main title is 'Sun Ray Administration' with the Java logo and 'Sun Microsystems, Inc.' on the right. A navigation bar contains tabs for 'Servers', 'Sessions', 'Desktop Units', 'Tokens', 'Advanced', and 'Log Files'. Below this, a sub-navigation bar has 'Security', 'System Policy', 'Kiosk Mode', 'Card Probe Order', and 'Data Store Password'. The 'Kiosk Mode' tab is selected, leading to the 'Edit Kiosk Mode' page. The page title is 'Edit Kiosk Mode' and the instruction is 'Specify the session type and the general properties for Kiosk Mode. Click OK to store the changes.' The configuration fields are: 'Session:' with a dropdown menu showing 'Common Desktop Environment', 'Common Desktop Environment', and 'Sun Java Desktop System 3'; 'Timeout:' with a dropdown menu showing 'Common Desktop Environment' and 'Sun Java Desktop System 3'; 'Maximum CPU Time:' with a text input field followed by 'seconds'; 'Maximum VM Size:' with a text input field followed by 'KB'; 'Maximum number of Files:' with a text input field; 'Maximum File Size:' with a text input field followed by '512B blocks'; 'Locale:' with a text input field; and 'Arguments:' with a wide text input field. At the bottom right, there are 'OK' and 'Cancel' buttons.

FIGURE 3-8 Edit Kiosk Mode Tab

# Smart Card Probe Order

The information provided about smart cards is extracted from vendor-supplied configuration files. These configuration files are located in the directory: `/etc/opt/SUNWut/smartcard`. Configuration files must be formatted correctly, and file names must end with a `.cfg` suffix, such as `acme_card.cfg`.

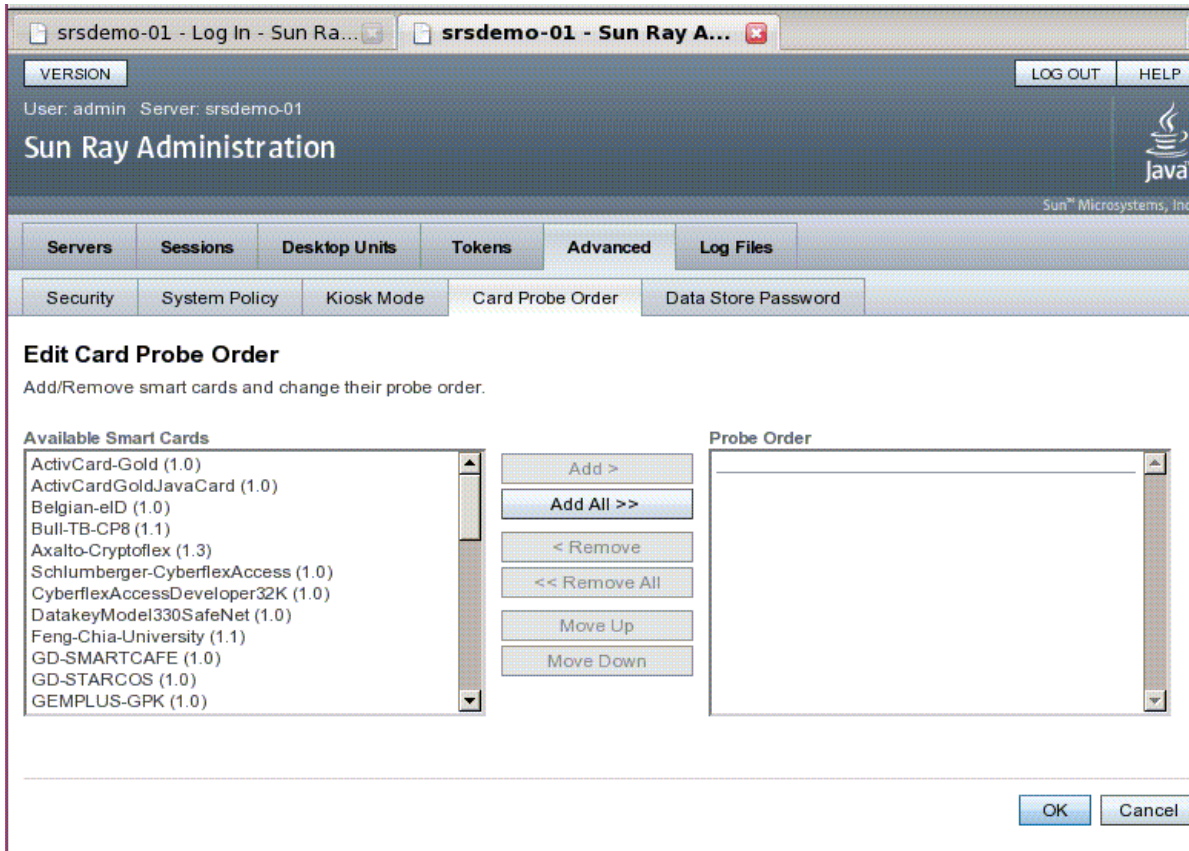
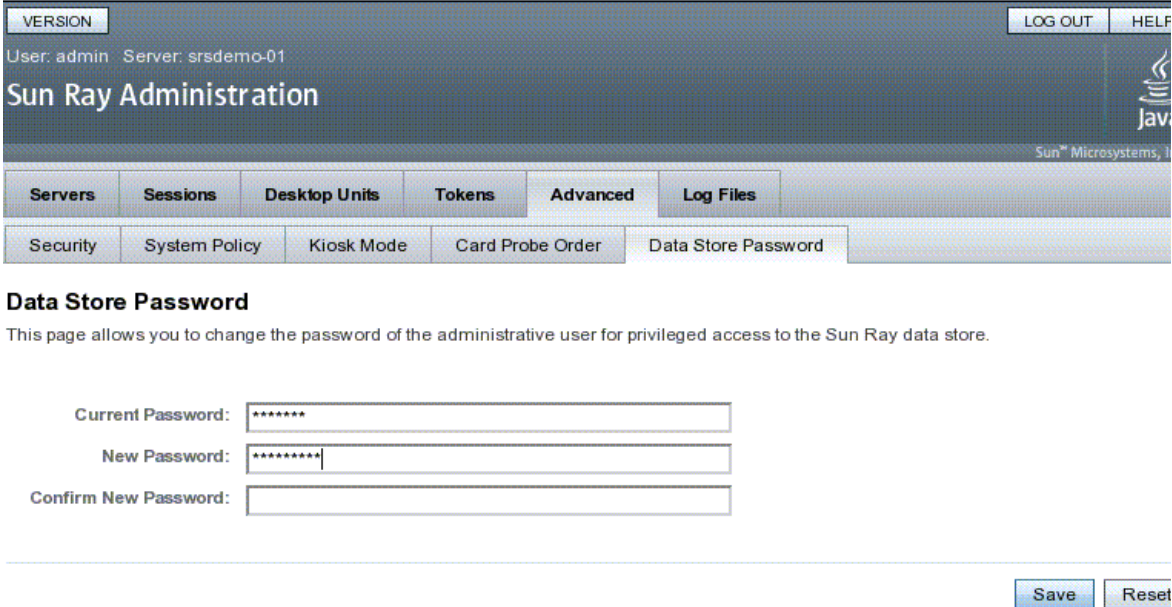

**FIGURE 3-9** Edit Smart Card Probe Order

Smart cards are probed in the order in which they appear in this list. As you add more cards, you can move those used most often to the top of the list.

# Data Store Password

The administrator's password allows you to use the Administration Tool to access and change Sun Ray administration data.



The screenshot shows the Sun Ray Administration web interface. At the top, there is a header with "VERSION" on the left, "LOG OUT" and "HELP" on the right, and "User: admin Server: srsdemo-01" in the center. Below the header is the "Sun Ray Administration" title and the Sun Microsystems logo. A navigation bar contains tabs for "Servers", "Sessions", "Desktop Units", "Tokens", "Advanced", and "Log Files". Below this is a secondary navigation bar with tabs for "Security", "System Policy", "Kiosk Mode", "Card Probe Order", and "Data Store Password". The "Data Store Password" tab is selected. The main content area is titled "Data Store Password" and contains the following text: "This page allows you to change the password of the administrative user for privileged access to the Sun Ray data store." Below this text are three password input fields: "Current Password:" with a masked password of seven asterisks, "New Password:" with a masked password of seven asterisks and a cursor, and "Confirm New Password:" which is empty. At the bottom right of the form are "Save" and "Reset" buttons.

**FIGURE 3-10** Use the Data Store Password Tab to Change the Admin Password

The Data Store Password tab allows you to change the password for the admin account. The password was set at configuration time (see [“Configure Sun Ray Server Software” on page 45](#) of the *Sun Ray Server Software 4.0 Installation and Configuration Guide for Solaris*).

This tab does not allow you to change UNIX user passwords.

---

**Note** – Every server in a failover group must use the same password for the admin account.

---

The layout of the data store is described in [“Managing User Data in the Sun Ray Data Store” on page 23](#). To allow other UNIX accounts to perform administrative functions, see [“Enabling Multiple Administration Accounts” on page 24](#).



# Log Files Tab

This tab provides sub-tabs for displaying the various log files recording events such as system messages, authentication logs, server administration events, mount logs, and storage related actions. To locate Sun Ray log files from the command line, see [“Examining Log Files” on page 38](#).

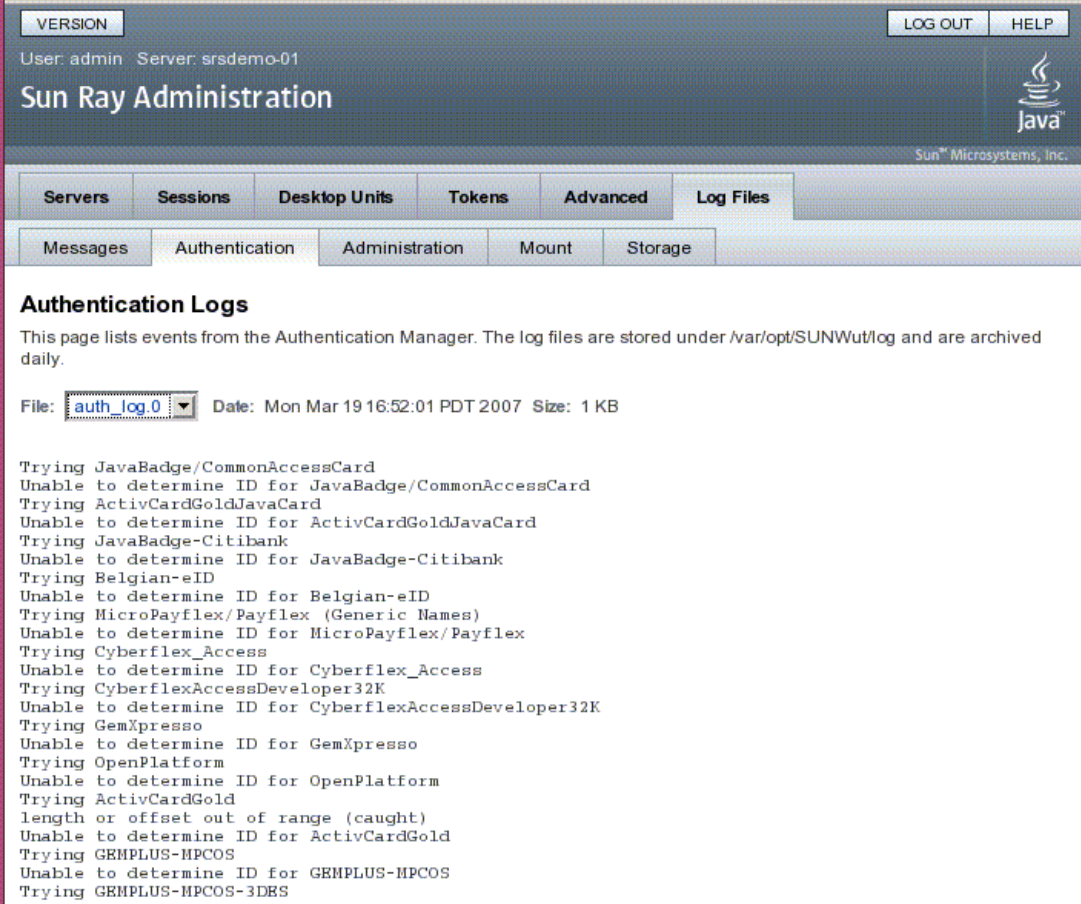

The screenshot shows the Sun Ray Administration web interface. At the top, there is a header with "VERSION" on the left and "LOG OUT" and "HELP" on the right. Below the header, it displays "User: admin Server: srsdemo-01" and the "Sun Ray Administration" title. The Sun Microsystems logo is visible in the top right corner. A navigation bar contains tabs for "Servers", "Sessions", "Desktop Units", "Tokens", "Advanced", and "Log Files". Under "Log Files", there are sub-tabs for "Messages", "Authentication", "Administration", "Mount", and "Storage". The "Authentication" sub-tab is selected, showing the "Authentication Logs" section. A text box indicates "This page lists events from the Authentication Manager. The log files are stored under /var/opt/SUNWut/log and are archived daily." Below this, there is a file selection dropdown showing "auth\_log.0" and a date "Date: Mon Mar 19 16:52:01 PDT 2007 Size: 1 KB". The main content area displays a log excerpt with the following text:

```
Trying JavaBadge/CommonAccessCard
Unable to determine ID for JavaBadge/CommonAccessCard
Trying ActivCardGoldJavaCard
Unable to determine ID for ActivCardGoldJavaCard
Trying JavaBadge-Citibank
Unable to determine ID for JavaBadge-Citibank
Trying Belgian-eID
Unable to determine ID for Belgian-eID
Trying MicroPayflex/Payflex (Generic Names)
Unable to determine ID for MicroPayflex/Payflex
Trying Cyberflex_Access
Unable to determine ID for Cyberflex_Access
Trying CyberflexAccessDeveloper32K
Unable to determine ID for CyberflexAccessDeveloper32K
Trying GemXpresso
Unable to determine ID for GemXpresso
Trying OpenPlatform
Unable to determine ID for OpenPlatform
Trying ActivCardGold
length or offset out of range (caught)
Unable to determine ID for ActivCardGold
Trying GEMPLUS-MPCOS
Unable to determine ID for GEMPLUS-MPCOS
Trying GEMPLUS-MPCOS-3DES
```

FIGURE 3-11 Sample Excerpt From an Authentication Log



## Peripherals for Sun Ray DTUs

---

This chapter contains information about selected USB, parallel, and serial devices and printing from Sun Ray DTUs.

- “Device Nodes and USB Peripherals” on page 55
- “Mass Storage Devices” on page 58
- “Attached Printers” on page 60
- “PDA Synchronization” on page 63
- “Adapters” on page 64

There are two kinds of peripherals: serial and parallel. Serial peripherals enable RS-232-style serial connections to the Sun Ray DTU. Parallel peripherals enable printing and come in two types: adapters and direct USB-connected printers.

Third-party adapters are useful for supporting legacy serial and parallel devices.

Sun Ray Server Software recognizes a parallel printer with an adapter as a USB printer.

---

**Note** – The printer naming conventions in Sun Ray Server Software differ from those in a Solaris operating environment.

---

---

## Device Nodes and USB Peripherals

Sun Ray Server Software creates a device directory called `IEEE802.MACID` in the `/tmp/SUNWut/units` directory. This directory contains the MAC address for each DTU on the interconnect. The `IEEE802.MACID` directory for each DTU contains `dev` and `devices` directories, analogous to the `/dev` and `/devices` directories in the Solaris operating environment. The Sun Ray `dev` directory contains a

representation of the logical topology of the devices connected to the DTU. The Sun Ray `devices` directory contains a representation of the physical topology of some of the devices connected to the DTU.

---

**Note** – Sun Ray Server Software does not create device nodes for every USB device. Some USB device drivers export their device interfaces through other mechanisms than a traditional UNIX device node.

---

Directories correspond to buses and hubs, and files correspond to ports. Hub directories are named according to the port on the upstream hub into which they are attached.

## Device Nodes

In Sun Ray `devices`, device nodes are created for each serial or printer port on an attached USB device. The device nodes are created in the hub directory corresponding to the hub to which they are attached. They are named:

*manufacturer\_name, model\_name@upstream\_hub\_port*

If the USB device has multiple identical ports (for example, two serial ports), the name is followed by `:n` where `n` is a numerical index, starting at 1.

The following is a typical device node path:

`/tmp/SUNWut/units/IEEE802.MACID/devices/usb@1/hub@1/\nmanufacturer_name, model_name@3:1`

**TABLE 4-1** Definitions of Naming Conventions

Term	Definition
<i>physical topology</i>	The <i>physical topology</i> is <code>hub@port/hub@port</code> and so on. The <i>port</i> refers to the port on the parent hub into which the device or child hub is plugged.
<i>printer name 1, terminal name 1</i>	The printer and terminal name in the Sun Ray <code>devices</code> directory is <i>manufacturer, model@port</i> with a colon separating the numerical index when the string just described is not unique in the directory.
<i>printer name 2, terminal name 2</i>	The printer and terminal name in the Sun Ray <code>dev</code> directory is the manufacturer and serial number concatenated with an alphabetic index when the serial number is not unique.

## Device Links

Device links are created under the `dev` directory. A link to each serial node is created in `dev/term`, and a link to each parallel node is created in `dev/printers`.

Typical device links are:

```
/tmp/SUNWut/units/IEEE802.080020cf428a/dev/term/manufacturer_name-67a  
/tmp/SUNWut/units/IEEE802.080020cf428a/dev/printers/1608b-64
```

```
manufacturer_name-serial_numberindex
```

where *index* is an increasing alphabetical character, starting at a.

If the manufacturer name is not available, the USB vendor and product ID numbers are used for the name of the device link.

## Device Node Ownership

Some device nodes are owned by the user whose session is active on the DTU, while others may be owned by root or by other users that may have had previously active sessions on the DTU. Device permissions, access controls and ownership rules are determined by the class of device. For serial and parallel devices, only the user whose session is active on the DTU or the superuser have permission to use the attached device. If there is no user with an active session, superuser owns the serial and parallel device nodes. This rule may not hold for other classes of USB devices connected to the DTU.

## Hotdesking and Device Node Ownership

The following description of the behavior of USB devices when sessions are connected and disconnected from a DTU applies only to USB serial and USB parallel devices. Other device classes may have different semantics regarding ownership and device lease times.

Changing the active session on a DTU changes the ownership of the device nodes to the user associated with the new session. A session change occurs whenever a user:

- Inserts or removes a smart card from a DTU
- Logs into a session

In a failover environment, you can use the `utselect` or `utswitch` command to change a session. A session change causes all devices currently open by a non-root user to be closed after 15 seconds. Any input or output to or from any affected device results in an error. Devices currently opened by the superuser, including normal Solaris printing, remain unaffected by the session change.

---

**Note** – When a session is changed, any input or output in progress on a device node opened by a non-root user is cancelled after 15 seconds. If the original session is restored within 15 seconds, the ownership is not relinquished, and input and output continue uninterrupted.

---

## Mass Storage Devices

### Device Nodes and Links

Mass storage devices have two types of device nodes, block and raw, which are created in the DTU's device directory. A link to the block device is created in the DTU's `dev/dsk` directory and a link to the raw device is created in the `dev/rdisk` directory.

Device links have a suffix denoting their slice number. Slice `s2` is known as the backup slice, signifying the complete disk. Other slices are numbered accordingly on the file system on the disk. For UFS disks, slice numbers are derived from the disk label. For FAT disks, slices (partitions in this case) are numbered starting from `s0`. Disk operations such as `format` or `eject` should be directed at slice `s2`. Partition operations such as `mount` or `fstyp` should be directed at the individual slice concerned. See [TABLE 4-2](#) for examples.

### Mount Points

When a mass storage device is plugged into the DTU, if it has a Solaris-recognizable file system, it is automatically mounted on a directory under the user's mount parent directory. The mount parent directory is located in `$DTDEVROOT/mnt/`. The user can also locate mount points by using the `-l` option to the `utdiskadm` command:

```
% /opt/SUNWut/bin/utdiskadm -l
```

# Device Ownership and Hotdesking

When the user's session disconnects from the DTU, the user loses access rights to the mass storage device. All pending I/O to the device is aborted. This can cause the data on the device to be corrupted. Please advise users to use the `utdiskadm` command as follows to unmount all file systems safely before hotdesking or unplugging the disk from the DTU:

```
% /opt/SUNWut/bin/utdiskadm -r device_name
```

---

**Note** – Before running this command, close all references to files and directories in the mount point to ensure that the device is not busy.

---

## Mass Storage Devices and NSCM

If an active NSCM session becomes idle long enough to activate the screen lock, the NSCM session is disconnected. The user loses access to the storage device, causing any I/O in progress to abort, and data may become corrupted.

## Common Disk Operations

TABLE 4-2 is a summary of common disk operations and the commands used to perform them. Refer to the *Solaris System Administration Guide* and man pages for more information on the individual commands.

**TABLE 4-2** Commands for Common Disk Operation on SPARC and x86 Platforms

OPERATION	COMMAND	DEVICE NAME ARGUMENT EXAMPLES (SPARC)	DEVICE NAME ARGUMENT EXAMPLES (x86)
format	<code>rmformat (1)</code>	path of whole disk \$UTDEVROOT/dev/rdisk/disk3s2	path of whole disk \$UTDEVROOT/dev/rdisk/disk3p0
create file system	<code>mkfs (1M)</code>	path of partition \$UTDEVROOT/dev/rdisk/disk3s0	path of partition \$UTDEVROOT/dev/rdisk/disk3p1
create UFS file system	<code>newfs (1M)</code>	path of slice \$UTDEVROOT/dev/rdisk/disk3s0	path of slice \$UTDEVROOT/dev/rdisk/disk3s0
mount	<code>utdiskadm -m</code>	partition name disk3s0	partition name disk3p1

**TABLE 4-2** Commands for Common Disk Operation (*Continued*) on SPARC and x86

OPERATION	COMMAND	DEVICE NAME ARGUMENT EXAMPLES (SPARC)	DEVICE NAME ARGUMENT EXAMPLES (x86)
unmount	utdiskadm -u	mount point \$DTDEVROOT/mnt/label1	mount point \$TDEVRROOT/mnt/label1
prepare to unplug	utdiskadm -r	device alias disk3	device alias disk3
eject media	utdiskadm -e	device alias disk3	device alias disk3
check for media	utdiskadm -c	device alias disk3	device alias disk3
create fdisk table	fdisk(1M)	path of whole disk \$UTDEVROOT/dev/rdisk/disk3s2	path of whole disk \$TDEVRROOT/dev/rdisk/disk3p0
repair file system	fsck(1M)	path of raw slice \$UTDEVROOT/dev/rdisk/disk3s0	path of raw partition \$TDEVRROOT/dev/rdisk/disk3p1
display file system capacity	df -k	mount point \$DTDEVROOT/mnt/label1	mount point \$TDEVRROOT/mnt/label1
display slice capacity	prtvtoc(1M)	path of backup slice \$UTDEVROOT/dev/rdisk/disk3s2	path of backup slice \$TDEVRROOT/dev/rdisk/disk3s2
list devices	utdiskadm -l	none	none

## Attached Printers

Sun Ray Server Software supports PostScript™ printers connected directly to a USB port on the Sun Ray DTU or connected through a USB-to-parallel port adapter. For non-PostScript printer support, refer to [“Non-PostScript Printers” on page 63](#).

---

**Note** – The lp subsystem opens the device node as superuser for each print request, so print jobs are not affected by hotdesking.

---

For more information on Solaris Ready™ printers, go to:

<http://www.sun.com/solarisready/>

# Printer Setup

Starting a print queue on a printer attached to a Sun Ray DTU, either directly or through an adapter, is identical to starting a print queue in the Solaris operating environment.

## ▼ To Set Up a Printer

1. Log in as superuser on a Sun Ray DTU.
2. To determine the MAC address of the DTU, press the three audio option keys to the left of the power key in the upper right corner of the keyboard.

The alphanumeric string displayed above the connection icon is the MAC address.

3. To locate the Sun Ray DTU, type:

```
# cd /tmp/SUNWut/units/*MAC_address
# pwd
/tmp/SUNWut/units/IEEE802.MACID/
```

The path to the extended MAC address for your particular Sun Ray DTU is displayed.

4. Locate the port for the printer by typing:

```
# cd dev/printers
# pwd
/tmp/SUNWut/units/IEEE802.MACID/dev/printers
#ls
printer-node-name
```

5. In the directory, locate the printer node.
6. For Solaris 8 or Solaris 9:

- a. Start the Admin Tool by typing:

```
# admintool &
```

- b. Go to Browse -> Printers -> Edit -> Add -> LocalPrinter.

- c. Type in:

- i. Printer name: *printername*

**ii. Description (optional)**

**iii. Printer Port**

Choose `Other` to enter the printer port path name. To locate the printer port, refer to [Step 4](#) above.

```
/tmp/SUNWut/units/IEEE802.MACID/dev/printers/printer-node-name
```

---

**Note** – Do not use the port name under the `devices` directory.

---

**d. Click OK.**

**e. If you are using a PostScript printer, under Printer Type choose PostScript unless your printer is listed.**

**f. Select the printer type according to your printer model. If no option matches, select other; then type your printer type or unknown.**

**g. If you are using a PostScript printer, under File Contents choose PostScript and ASCII.**

**h. Options: Default Printer (optional)**

**i. Click OK.**

---

**Note** – Do not click OK more than once. If you do, a failure message is displayed.

---

**7. For Solaris 10, use the following steps instead:**

**a. Start the PrintManager by typing:**

```
# /usr/sbin/printmgr &
```

**b. Click OK to choose files for repository.**

**c. Go to Browse -> Printers -> Edit -> Add -> LocalPrinter.**

**d. Type in:**

**i. Printer name:** *printername*

**ii. Description (optional)**

**iii. Printer Port**



Choose `Other` to enter the printer port path name. To locate the printer port, refer to [Step 4](#) above.

**8. To verify that the printer has been set up correctly, type:**

```
# lpstat -d printername
```

## Non-PostScript Printers

Printers that do not use PostScript, such as engineering plotters, are best supported by third-party software. Low-cost inkjet printers require third-party software such as:

- Easy Software's ESP PrintPro, available from <http://www.easysw.com>
- Ghostscript, available from <http://www.ghostscript.com>
- Vividata PShop, available from <http://www.vividata.com>

Check with the vendors for pricing and the precise printer models supported.

---

## PDA Synchronization

To synchronize PDAs that use the Palm OS to a Sun Ray DTU, use a USB-to-serial adapter. For troubleshooting information, see [“PDA Synchronization Issues” on page 219](#).

## PDASync for Solaris Application on Sun Ray DTUs

PDASync for Solaris™ requires a compatible version of the Java Communications API 2.0.2 or a later version to run on the Sun Ray DTU. Version 3 or later is recommended.

Certain components of the Java Communications API package must be installed in specific directories for PDASync for Solaris to run.

### ▼ To Set Up the PDASync Application on a Sun Ray DTU

- 1. Log in as superuser.**

2. Get the latest Java Communications API (javax.comm api version 3 and above) from

<http://java.sun.com/products/javacomm/>

3. Unzip the file by typing:

```
# unzip comm3.0_solaris.zip
```

4. Copy the CommAPI jar file into the PDASync installation base by typing:

```
# cp commapi/jar/comm.jar /usr/dt/appconfig/sdtpdasync/classes
```

5. Copy the CommAPI native library into the PDASync installation base by typing:

```
# cp commapi/lib/libSolarisSerialParallel.so \  
/usr/dt/appconfig/sdtpdasync/lib
```

6. Launch the PDASync application by typing:

```
# /usr/dt/bin/sdtpdasync
```

---

## Adapters

For a list of verified serial and parallel adapters, see:

[http://www.sun.com/io\\_technologies/sunray.html](http://www.sun.com/io_technologies/sunray.html)

---

## libusb

libusb is an Open Source user land USB API/library that enables an application to access USB devices. libusb has been implemented for a number of operating environments, including Linux, BSD, MacOS, and Windows, as well as for Solaris and Sun Ray environments.

libusb applications are capable of running on any operating environment that supports libusb. Sun Ray support for libusb requires two packages

- SUNWlibusb
- SUNWlibusb

For further information, see `/usr/sfw/share/doc/libusb/libusb.txt`.

SUNWlibusb is installed as part of SRSS 4.0. The SUNWlibusb package can be installed manually from the Supplemental area of the SRSS 4.0 CD.

If the SUNWlibusb package has not already been installed, the administrator should install it and then create a symbolic link as follows:

```
# cd /usr/sfw/lib/libusb_plugins
# ln -s /opt/SUNWut/lib/libusb.so.1 libusb.so.1
```

Some Open Source applications that make use of libusb support and enable users to access scanners, digital cameras, and other devices are listed below.

**TABLE 4-3** Open Source libusb Applications

Application	URL	Comments
Sane	<a href="http://www.sane-proj.org">http://www.sane-proj.org</a>	For scanner support
Gphoto	<a href="http://www.gphoto.org">http://www.gphoto.org</a>	For digital still cameras
ColdSync	<a href="http://www.coldsync.org">http://www.coldsync.org</a>	For Palm device support

For further information, please see:

- <http://sourceforge.net>.
- Sun Download Center
- The libusb man page



## Hotdesking (Mobile Sessions)

---

The Sun Ray system is designed to enable session mobility, or hotdesking, with smart cards. Every Sun Ray DTU is equipped with a smart card reader. Sun Ray Server Software 4.0 also includes the industry standard PC/SC-lite API for developers who wish to encode custom applications or other information in their users' smart cards. Custom applications are frequently used to provide strong smart card-based authenticated logins and PKCS#11, S/MIME digital signature message signing and encryption, among other capabilities. This enhancement requires no additional administration.

Configuring Sun Ray Server Software with non-smart card mobile (NSCM) sessions provides the benefits of hotdesking without the use of smart cards. This chapter explains NSCM sessions and how to configure them, and how to enable users to access their Sun Ray sessions across multiple failover groups (see [“Failover Groups” on page 167](#)).

This chapter contains the following sections:

- [“NSCM Session” on page 67](#)
- [“NSCM and Failover Groups” on page 72](#)
- [“Configuring the Authentication Manager for NSCM Sessions” on page 72](#)
- [“Regional Hotdesking” on page 76](#)

---

### NSCM Session

In an NSCM session, the user:

- Types a user name and password instead of inserting a smart card
- Types the `utdetach` command instead of removing a smart card.

If a user does not want to use the NSCM session, inserting a smart card causes the session to be disconnected and replaced by a smart card session.

# Sun Ray Mobile Session Login Dialog Box

When Sun Ray Server Software is configured for NSCM sessions, the Sun Ray Mobile Session Login dialog box is displayed on the Sun Ray DTU.

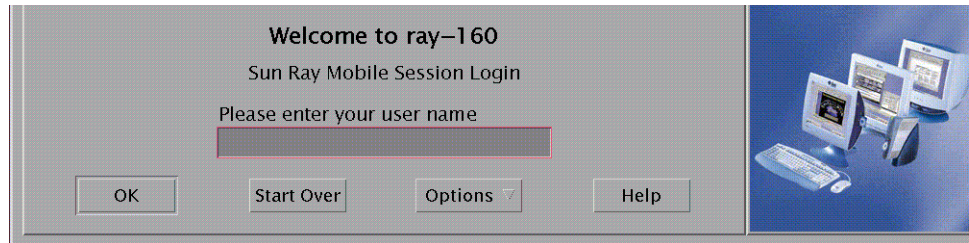

**FIGURE 5-1** Sun Ray Mobile Session Login Dialog Box

A right click on the Options button opens a panel where the user can select:

- **QuickLogin**—To a new session only. Selecting Off enables the user to login with the same options available through `dtlogin`. Selecting On enables the user to bypass the option selection phase. QuickLogin is on by default.
- **Exit**—Selecting Exit temporarily disables the NSCM session. An escape token session is started, and the dialog box is replaced by the `dtlogin` screen. A user without a valid user name for this server group can exit in order to login remotely (`rlogin`) to a server where the user name is valid.

## Token Reader Icon

When a site policy disallows NSCM sessions, DTUs configured as token readers display the token reader icon instead of the Login Dialog box.



## ▼ To Log In to an NSCM Session

1. Type a user name and then a password into the user entry field.

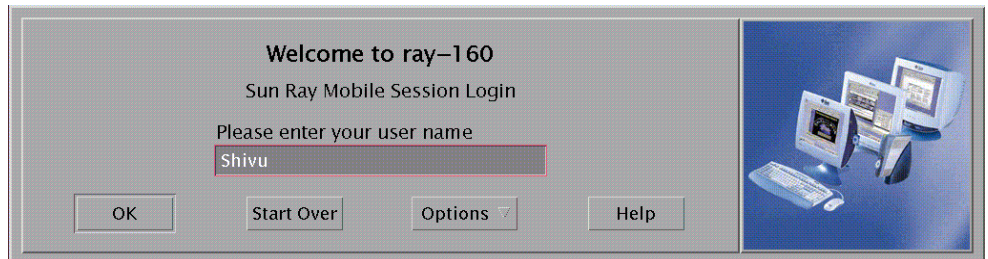
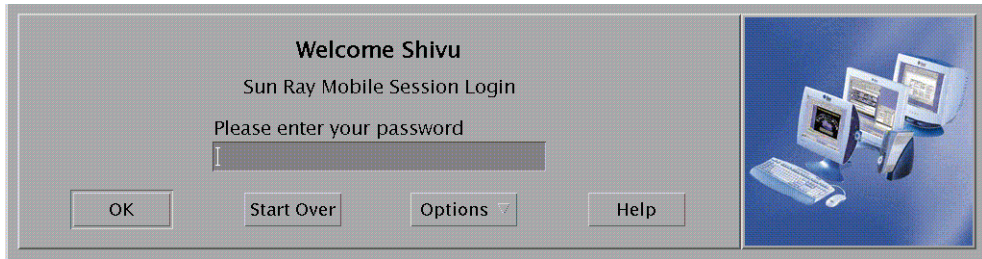

**FIGURE 5-2** User name Entry

If an NSCM session for this user does not exist, the Authentication Manager creates an NSCM session token for the user. The token has the format: `mobile.username`, where `username` is the user's UNIX ID.

If the Sun Ray server is part of a failover group, the load-balancing algorithm may redirect the user to another Sun Ray server, where the user types a user name and password again before an NSCM session is created. The Sun Ray administrator can control whether the user has to re-enter a user name and password pair.

If an NSCM session exists on a different Sun Ray server in a failover group, the user is redirected to the server where the most current NSCM session is located.



**FIGURE 5-3** User Password Entry

The Sun Ray Mobile Session Login dialog box is redisplayed with the host name of the new Sun Ray server, and the user must retype the user name and password.

---

**Note** – In previous versions, the Sun Ray administrator could prevent re-authentication behavior by setting the `acceptRedirectToken` property in the `/etc/opt/SUNWut/auth.props` file to `true`, after which users did not need to re-authenticate when redirected. This functionality is no longer enabled.

---

## Disconnecting an Active NSCM Session

If an NSCM session exists on the current Sun Ray server, it is displayed to the user. If a user wants to move to another location, there are two methods of disconnecting an NSCM session:

- Hot Key combination
- `utdetach`

### Hot Key

To disconnect an NSCM session, the user presses the key combination Shift-Pause.

### ▼ To Disconnect the Current Session via `utdetach`

1. Type the `utdetach` command in a shell window:

```
% /opt/SUNWut/bin/utdetach
```

2. Press the Shift and Pause keys simultaneously.



The Sun Ray Mobile Session Login dialog box is redisplayed, and the user moves to another Sun Ray DTU.

### 3. Login at the second Sun Ray DTU.

The session becomes active.

The user can terminate the session by selecting Exit (Logout) from the CDE Workspace Menu or by pressing the key combination Ctrl+Alt+Bksp+Bksp.

## ▼ To Terminate the Current Session

- **Click the Exit button on the CDE panel.**  
or
- **Press the key combination Ctrl+Alt+Bksp+Bksp.**

---

**Note** – There may be a momentary delay before the session terminates.

---

## ▼ To Reconfigure the Disconnect Hot Key Combination

You can change the disconnect key combination (hot key) in the `/etc/opt/SUNWut/utslaunch_defaults.properties` file, where the site-wide default configuration of the hotkey key combination is specified. Individual users can override the default key combination by configuring the `~/.utslaunch.properties` file located in their home directory.

- **Edit the respective file and find the line with the `utdetach.hotkey` property.**  
Change the string after the equals sign to the keystrokes desired. For example, to configure the key combination of Alt + Esc, type:

```
% utdetach.hotkey=Alt Escape
```

## ▼ To Customize the Short Cut for Disconnecting an NSCM Session

You can disconnect the current session using the key combination (hot key) in the `utslaunch.properties` files.

1. **To reconfigure the hot key combination, edit the file and find the line with the `utdetach.hotkey` property.**

## 2. Change the string after the equals sign to the keystrokes desired.

For example:

```
utdetach.hotkey=Alt Escape
```

configures the key combination of Alt+Esc.

---

# NSCM and Failover Groups

The user login experience for NSCM sessions may be different than expected when systems are configured as part of a failover group.

The following situations may produce unfamiliar behavior:

- Load Balancing Between Servers

If server A is heavily loaded when a user logs into it with the NSCM GUI, it redirects the user to server B, which may require another login with the NSCM GUI. If server B is running an earlier Solaris version than Server A, the user may have to log in a third time.

- Switching Between Servers

A user with a session on server A who wants to switch to a session on server B invokes the `utselect` GUI to access the other session. In doing so, the user is required to log in with the NSCM GUI. Users familiar with the ease of the `utselect` GUI might be discouraged that another login is necessary.

- Escape Token Sessions

The user bypasses the NSCM GUI by clicking the Exit button and logs into server A using `dtlogin`. The user now has a standard escape token session and invokes the `utselect` GUI to switch to server B, causing the NSCM GUI to be presented again. The user must click Exit again to get to the escape token session on server B. Users accustomed to switching rapidly may find this behavior annoying.

---

# Configuring the Authentication Manager for NSCM Sessions

The Sun Ray administrator can enable the NSCM session features with:

- Sun Ray Administration Tool
- Command-line interface

---

**Note** – If the IP addresses and DHCP configuration data are not set up properly at the time that the interfaces are configured, the failover feature will not work properly. In particular, configuring the Sun Ray server’s interconnect IP address as a duplicate of any other server’s interconnect IP address may cause the Sun Ray Authentication Manager to generate “Out of Memory” errors.

---

## ▼ To Enable NSCM Sessions From the Administration Tool

1. **Before changing the Authentication Manager policy, inform your users that all active and detached sessions will be lost.**

You can use the `utwall` command to send the notice of policy change. For example:

```
# /opt/SUNWut/sbin/utwall -d -t 'System policy will change in 10 minutes.\nAll active and detached sessions will be lost.\nPlease save all data and terminate your session now.' ALL
```

The following message is seen by all users in a pop-up window:

```
System policy will change in 10 minutes.\nAll active and detached sessions will be lost.\nPlease save all data and terminate your session now.
```

2. **Log in to the Administration Tool.**
3. **Go to the System Policy tab.**  
The Change Policy window is displayed.
4. **In the Non-Card Users panel, check the Enabled box next to Mobile Sessions.**

VERSION LOG OUT HELP

User: admin Server: srsdemo-01

# Sun Ray Administration

  
Sun Microsystems, Inc.

Servers	Sessions	Desktop Units	Tokens	Advanced	Log Files
Security	System Policy	Kiosk Mode	Card Probe Order	Data Store Password	

## Policy

This page allows you to configure group-wide policies.

### Card Users

Access:  None  
 All Users  
 Users with Registered Tokens

Self Registration Allowed  
 User Account Authentication Required

Kiosk Mode:  Enabled

### Non-Card Users

Access:  None  
 All Users  
 Users with Registered Tokens

Self Registration Allowed  
 User Account Authentication Required

Kiosk Mode:  Enabled

Mobile Sessions:  Enabled

Exit from Mobile Sessions Allowed

### Multihead

Multihead Feature:  Enabled

**FIGURE 5-4** Change Policy Window

#### 5. Go to the Servers tab.

6. Click **Cold Restart** to restart Sun Ray services and terminate all users' sessions.  
The NSCM sessions are enabled in a moment.

## ▼ To Enable NSCM Sessions From a Command Line

The Sun Ray administrator can toggle the NSCM session capability by including or excluding the `-M` argument in the `utpolicy` command. For more information, see the `utpolicy` man page.

1. **Before changing the Authentication Manager policy, inform your users that all active and detached sessions will be lost.**

You can use the `utwall` command to provide them the notice of policy change. For example:

```
# /opt/SUNWut/sbin/utwall -d -t 'System policy will change in 10
minutes.\nAll active and detached sessions will be lost.\nPlease
save all data and terminate your session now.' ALL
```

The following message is seen by all users in a pop-up window:

```
System policy will change in 10 minutes.
All active and detached sessions will be lost.
Please save all data and terminate your session now.
```

2. **As superuser, type the `utpolicy` command for your authentication policy with the addition of the `-M` argument. For example:**

```
# /opt/SUNWut/sbin/utpolicy -a -M -s both -r both
```

This example configures the Authentication Manager to allow self-registration of users both with or without smart cards, and NSCM sessions are enabled.

3. **Initialize Sun Ray services.**

- a. **Type this command to restart the Authentication Manager.**

```
# /opt/SUNWut/sbin/utrestart -c
```

This command clears all active and detached sessions

- b. Repeat [Step a](#) on each secondary Sun Ray server if in a failover group.

---

## Regional Hotdesking

Regional hotdesking can be enabled by means of multiple failover groups. Multiple failover groups are useful for various reasons, such as:

- Availability

It is sometimes advantageous to have multiple, geographically-separate locations, each with a failover group, so that if an outage occurs at one location, another location can continue to function.

- Organizational Policies

Some sites have different administrative policies at different locations. It can be advantageous to keep separate failover groups at these locations.

Regional hotdesking, sometimes referred to as Automatic Multi-Group Hotdesking (AMGH), is useful when an enterprise has multiple failover groups and users who move from one location to another who wish to gain access to their existing session wherever they roam. The following sections describe regional hotdesking. For further technical detail, please refer to the `utamghadm(1M)`, `ut_amgh_get_server_list(3)`, and `ut_amgh_script_interface(3)` man pages.

---

**Note** – Regional hotdesking is not enabled for multihead groups.

---

## Functional Overview

Once regional hotdesking is configured, user login information and sessions are handled as follows:

1. When a smart card is inserted or removed from the system or a user logs in via the greater GUI, parameters such as the user name (if known at the time), smart card token, and terminal identifier are passed to a piece of site-integration logic.
2. The site-integration software uses these parameters to determine to which Sun Ray servers it should direct the Sun Ray DTU.
3. If the smart card token is associated with a local session, then that session gets preference, and regional hotdesking is not invoked.

4. Otherwise, the regional hotdesking software redirects the Sun Ray DTU to connect to the appropriate Sun Ray server.

Thus, if the user has an existing session, the DTU connects to that session; if not, the regional hotdesking software creates a new session for that user.

## Site Requirements

To utilize regional hotdesking, a site must provide some site integration logic that can utilize enterprise data to determine which users or Sun Ray DTUs should connect to which failover groups. This is ordinarily provided through the use of a dynamic C library or a shell script that implements a particular interface used by regional hotdesking software. SRSS provides some reference code that a site administrator can use as an example or adapt as required. An administrator must configure the regional hotdesking software to utilize a specified library or shell script, then implement the PAM stack of the login applications, as described below.

---

**Note** – To ensure continuous operation, be sure to include enough servers in the target group to provide availability for session location and placement in the event that a particular server becomes unavailable. Two servers should be minimally sufficient for most sites; three servers provide a conservative margin of error.

---

# Providing Site Integration Logic

To determine where given Sun Ray DTUs or users should be connected when creating or accessing sessions, the administrator must utilize enterprise data. Sun Ray Server Software 4.0 includes for this purpose:

- man pages, such as `ut_amgh_get_server_list(3)`, which describe the appropriate C API for a shared library implementation
- A shell-script API, `ut_amgh_script_interface(3)`, which can be used as an alternative.
- Reference C code and script code, located at `/opt/SUNWutref/amgh`. This code can serve as example or be directly adapted for use.
- A functional Makefile.

## ▼ To Configure a Site-specific Mapping Library

The administrator for each site must determine what mapping library to use. It may be a site-specific implementation, as described above, or one of the sample implementations provided with the SRSS software.

Use the `/opt/SUNWut/sbin/utamghadm` command to configure the regional hotdesking software to use this library.

1. To configure the token-based mapping implementation provided as a sample, execute the following:

```
# /opt/SUNWut/sbin/utamghadm -l /opt/SUNWutref/amgh/libutamghref_token.so
```

2. To configure the user name-based mapping implementation provided as a sample, execute the following:

```
# /opt/SUNWut/sbin/utamghadm -l /opt/SUNWutref/amgh/libutamghref_username.so
```

3. To configure a script-based back-end mapping (for example, the token-and-user name-combination-based mapping sample), use the `-s` option to this command:

```
# /opt/SUNWut/sbin/utamghadm -s /opt/SUNWutref/amgh/utamghref_script
```

4. Do a cold restart of the SRSS services using either the `utrestart` CLI or the Admin GUI.



## Token Readers

To utilize token readers along with regional hotdesking based on Sun Ray *pseudo-tokens*, use the Site-specific Mapping Library to produce the desired behavior for them.

Configured token readers should have the following value formats:

*Key	*Value
insert_token	pseudo.<MAC_address>
token	TerminalId.<MAC_address>

**Note** – If a registered policy is in place, use the `insert_token` key instead of the `token` key, which is not globally unique.

### ▼ To Configure the Sample Data Store

Each site must configure a data store to contain site-specific mapping information for regional hotdesking. This data store is used by the site mapping library to determine whether regional hotdesking should be initiated for the parameters presented. The data store can be a simple flat file. The sample implementations included with the SRSS require a simple flat file configuration.

- **Create the back-end database file under** `/opt/SUNWutref/amgh/back_end_db` **on the Sun Ray server:**

- a. **For a token-based mapping, use entries of the form:**

```
token=XXXXXXXX [username=XXXXX] host=XXXXX
```

- Comments (lines beginning with #) are ignored.
- User name is optional. If the same token is associated with more than one non-null user name, an error is returned.

- b. **For a user name-based mapping, use entries of the form:**

```
username=XXXXX host=XXXXX
```

- Comments (lines beginning with #) are ignored,
- Key/value pairs other than those mentioned above are ignored.
- The order of key/value pairs is not significant.

**c. For a combined mapping, use entries of the form:**

```
Any combination of TOKEN BASED and USERNAME BASED lines.
```

- Comments (lines beginning with #) are ignored,
- A token match is attempted first.
- If none is made (or if no user name is included in the matches) the user is prompted for a user name.
- A lookup is made for this user name. If there is no match, a local session is created; otherwise, the Sun Ray DTU is forwarded to the first host reported as available.

A sample line for this file would look like the following:

```
token=MicroPayflex.5001436700130100 username=user1 host=ray-207
```

---

**Note** – Tokens for NSCM and authenticated smart cards have the form `auth.<username>`. These tokens cannot be affected by AMGH. Use the `username` key instead.

---

## ▼ To Disable Regional Hotdesking

1. To disable AMGH configuration for a group, run the following command:

```
% /opt/SUNWut/sbin/utamghadm -d
```

2. Do a cold restart of the SRSS services using either the `utrestart` CLI or the Admin GUI.

# Encryption and Authentication

---

Sun Ray Server Software provides interconnect security. Two main aspects of this feature are:

- Traffic encryption between the Sun Ray client and server
- Sun Ray server-to-client authentication

---

## Introduction

In earlier versions of Sun Ray Server Software, data packets on the Sun Ray interconnect were sent “in the clear”. This made it easy to “snoop” the traffic and recover vital and private user information, which malicious users might misuse. To avoid this type of attack, Sun Ray Server Software allows administrators to enable traffic encryption. This feature is optional; the system or network administrator can configure it based on site requirements.

The ARCFOUR encryption algorithm, selected for its speed and relatively low CPU overhead, supports a higher level of security between Sun Ray services and Sun Ray desktop units. In the Sun Ray Server Software 2.0 release, only the X server traffic was encrypted.

Encryption alone does not provide complete security. It is still possible, if not necessarily easy, to spoof a Sun Ray server or a Sun Ray client and pose as either. This leads to the man-in-the-middle attack, in which an impostor claims to be the Sun Ray server for the clients and pretends to be client for the server. It then goes about intercepting all messages and having access to all secure data.

Client and server authentication can resolve this type of attack. This release offers server-side authentication only, through the pre-configured public-private key pairs in Sun Ray Server Software and firmware. The Digital Signature Algorithm (DSA) is used to verify that clients are communicating with a valid Sun Ray server. This

authentication scheme is not completely foolproof, but it mitigates trivial man-in-the-middle attacks and makes it harder for attackers to spoof Sun Ray Server Software.

---

## Security Configuration

When configuring the security for a Sun Ray system, you should evaluate the security requirements. You may choose:

- to enable encryption for upstream traffic only
- to enable encryption for downstream traffic only
- to enable bidirectional encryption
- to enable server authentication (client authentication is not currently available)

Additionally, you must decide whether to enable hard security mode. To configure your site, you can use the `utcrypto` command or the Sun Ray Administration Tool (Admin GUI).

## Security Mode

Hard security mode ensures that every session is secure. If security requirements cannot be met, the session is refused. Soft security mode ensures that every client that requests a session gets one; if security requirements cannot be met, the session is granted but not secure.

For example, in hard security mode, if any Sun Ray DTU that does not support security features (for instance, because of old firmware) connects to a Sun Ray server, the server denies the session.

In soft security mode, given the above situation, the Sun Ray server grants the DTU a non-secure session. It is now up to the user to decide whether to continue using a non-secure session.

For more information, please see the man page for `utcrypto` or [“Administration Tool” on page 37](#).

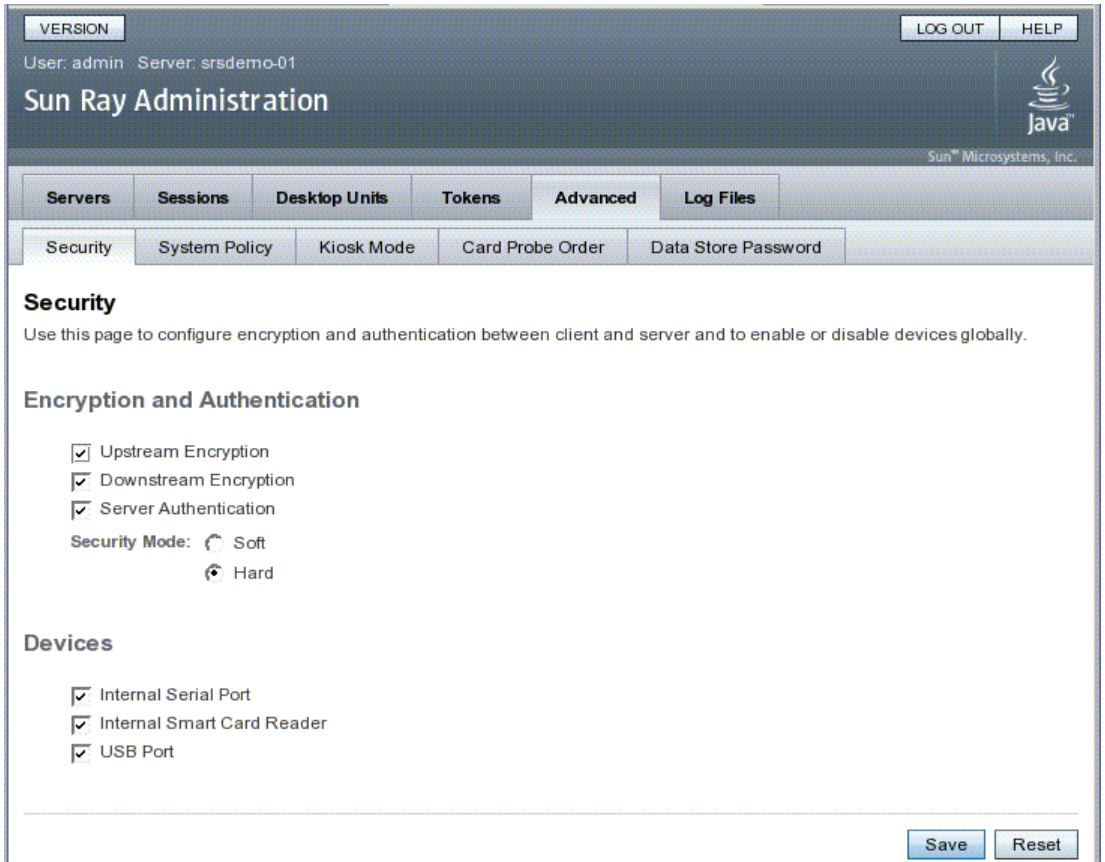

FIGURE 6-1 Sun Ray Security Configuration Tab

## Session Security

Use the `utsession` command to display session status. Its output has been modified to include security status for a session. The State column in `utsession -p` output now displays the encrypted/authenticated state of the session by using *E* for encrypted and *A* for authenticated session types. This information is not displayed for any session in the disconnected state.

In a multihead environment, there may be a case where the primary and the secondary servers have different firmware. For instance, if the secondary has version 1.3 or earlier firmware, it cannot support any of the security features. In this case, the lowest security setting is displayed. In other words, if the secondary server is

configured with 1.3 firmware and the primary server with SRSS 2.0, 3.0, 3.1, or 4.0 firmware, and encryption and authentication are configured, then neither an *E* or an *A* is displayed.

```
# utsession -p
Token ID Registered NameUnix IDDisp State
Payflex.0000074500000202 ??? ??? 2IEA
Micropayflex.000003540004545??????3D
```

## Security Status

Once a connection has been successfully established between a client and a server, the user can determine whether the connection is secure at any time by pressing the three volume keys simultaneously to display a status icon, which also shows the DTU's MAC. For a description of OSD icons and their respective codes, see ["Understanding OSD" on page 195](#).

## Deployment on Shared Networks

---

This chapter describes the process of deploying DTUs on shared network segments. It covers the following topics:

- [“Sun Ray DTU Initialization Requirements” on page 86](#)
- [“Network Topology Options” on page 88](#)
- [“Network Configuration Tasks” on page 91](#)
- [“Network Performance Requirements” on page 107](#)
- [“Troubleshooting Tools” on page 110](#)
- [“Remote Configuration” on page 111](#)
- [“Firmware Download” on page 112](#)
- [“Routerless VPN Capability” on page 113](#)
- [“Pop-up GUI” on page 113](#)
- [“Remote Loading of Configuration Data” on page 118](#)
- [“Ports and Protocols” on page 120](#)

When first introduced, Sun Ray DTUs could be deployed only on dedicated, directly-connected interconnect subnets. Although dedicated interconnects provide reliable service and are easy to configure, they require the full-time commitment of networking equipment, cabling, and host interfaces. This constraint has been removed from SRSS 2.0 and later releases, allowing network administrators to deploy Sun Ray DTUs nearly anywhere on an enterprise intranet. The most important advantages of intranet deployment are:

- Sun Ray can be deployed on any existing network infrastructure that meets Sun Ray Quality of Service (QoS) requirements.
- Sun Ray DTUs can be deployed at a greater distance from their Sun Ray server.

---

# Sun Ray DTU Initialization Requirements

Because Sun Ray DTUs are stateless, they rely entirely on network services to provide the configuration data they need to complete their initialization.

- Each DTU must first acquire basic network parameters, such as a valid IP address, on the network to which it is connected.
- The DTU can also be supplied with additional configuration information to support advanced product features, such as the ability to update the DTU firmware and to report exception conditions to a syslog service.
- The DTU must locate and contact a Sun Ray server that can offer desktop services to the Sun Ray user.

The Sun Ray DTU uses the Dynamic Host Configuration Protocol (DHCP) to obtain this information.<sup>1</sup>

## DHCP Basics

The DTU is a DHCP client that solicits configuration information by broadcasting DHCP packets on the network. The requested information is supplied by one or more DHCP servers in response to the client's solicitations. DHCP service may be provided by a DHCP server process executing on a Sun Ray server, by DHCP server processes executing on other systems, or by some combination of the two. Any conforming implementation of a DHCP service can be used to satisfy the DHCP requirements of the DTU. Sun's Solaris DHCP service is one such implementation. Third-party implementations executing on non-Sun platforms can also be configured to deliver information to Sun Ray DTUs.

The DHCP protocol defines a number of *standard options* that can be used to inform the client of a variety of common network capabilities. DHCP also allows for a number of *vendor-specific options* (see [TABLE 7-2](#)), which carry information that is meaningful only to individual products.

The Sun Ray DTU depends on a small number of standard options to establish its basic network parameters. It depends on several standard and vendor-specific options to provide the additional information that constitutes a complete DTU configuration. If these additional configuration parameters are not supplied, the DTU cannot perform certain activities, the most important of which is the downloading of new DTU firmware. [TABLE 7-2](#) lists the vendor-specific options.

---

1. DHCP is an Internet Engineering Task Force (IETF) protocol described in Requests for Comments (RFC) *RFC 2131* and *RFC 2132*.



---

**Note** – If an administrator chooses not to make this additional configuration information available to the Sun Ray DTUs, a procedure must be established to deliver firmware updates to them. One solution would be a small, dedicated interconnect on one Sun Ray server. Then, the administrator can transfer the DTUs one-by-one when new firmware becomes available on the server, for instance, through a patch or Sun Ray product upgrade.

---

The location of the Sun Ray server is usually conveyed to the DTU through one of a pair of DHCP vendor-specific options, *AuthSrvr* and *AltAuth* (see [TABLE 7-2](#)).

If the DTU does not receive this information, it uses a broadcast-based discovery mechanism to find a Sun Ray server on its subnet. The DTU firmware now goes one step further. If the broadcast-based discovery mechanism fails, the DTU interprets the DHCP standard option (option 49) of the *X Window Display Manager* as a list of Sun Ray server addresses where it attempts to contact Sun Ray services (see [“Configure the external DHCP service.” on page 104](#)). This can simplify the DHCP configuration of LAN-deployed Sun Rays by removing the need for a DHCP vendor option to carry this information (see [TABLE 7-1](#)).

**TABLE 7-1** DHCP Service Parameters Available

Parameters	Sun Ray Server DHCP Service	External DHCP service with vendor-specific options	External DHCP service without vendor-specific options	No DHCP service
Basic network parameters	Yes	Yes	Yes	No
Additional parameters (for firmware download, etc.)	Yes	Yes	No	No
Sun Ray server location	Yes	Yes	Yes, through broadcast discovery or the <i>X Display Manager</i> standard option	Yes, through broadcast discovery

## DHCP Parameter Discovery

DHCP enables two stages of parameter discovery. The initial DHCPDISCOVER stage discovers basic network parameters. This stage may be followed by a DHCPINFORM, which finds additional information that was not provided during DHCPDISCOVER.

All Sun Ray DTUs must have access to at least one DHCP service, which provides network parameters in response to a DHCPDISCOVER request from the DTU. DTUs containing firmware delivered with Sun Ray Server Software 2.0 or later can exploit the DHCPINFORM feature. They enable full configuration of the DTU, even when an external DHCP service that is not capable of providing complete configuration data provides the network parameters of the DTU.

DTUs that contain pre-2.0 firmware require all of their configuration information in the initial DHCPDISCOVER phase. They do not attempt a DHCPINFORM step. If the deployment strategy requires a two-step DHCP interaction, such DTUs must be upgraded with Sun Ray Server Software firmware version 2.0 or later before being deployed on a shared subnet.

## DHCP Relay Agent

The DTU sends DHCP requests as broadcast packets that propagate only on the local LAN segment or subnet. If the DTU resides on the same subnet as the DHCP server, the DHCP server can see the broadcast packet and respond with the information the DTU needs. If the DTU resides on a different subnet than the DHCP server, the DTU must depend on a local DHCP Relay Agent to collect the broadcast packet and forward it to the DHCP server. Depending on the physical network topology and DHCP server strategy, the administrator may need to configure a DHCP Relay Agent on each subnetwork to which Sun Ray clients are connected. Many IP routers provide DHCP Relay Agent capability. If a deployment plan requires the use of a DHCP Relay Agent, and the administrator decides to activate this capability on a router, the appropriate instructions can be found in the router documentation, usually under the heading of “DHCP Relay” or “BOOTP forwarding.”<sup>2</sup>

In certain cases, an existing enterprise DHCP service provides the DTU with its IP address while a Sun Ray server provides it with firmware version details and Sun Ray server location. If a deployment plan calls for DHCP parameters to be provided to the DTU by multiple servers, and none of those servers is connected to the subnet where the DTU resides, the DHCP Relay Agent should be configured so that the DTUs subnet can deliver broadcasts to all the DHCP servers. For example, in routers controlled by a Cisco IOS Executive (see [“Deployment on a Remote Subnet” on page 99](#)), the `ip helper-address` command activates a DHCP Relay Agent. Specifying multiple arguments to the `ip helper-address` command enables relaying to multiple DHCP servers.

---

## Network Topology Options

There are three basic topology options for Sun Ray deployment. DTUs can be deployed on:

- a directly-connected dedicated interconnect.
- a directly-connected shared subnet.
- a remote shared subnet.

---

2. DHCP is derived from an earlier protocol called BOOTP. Some documentation uses these names interchangeably.

A Sun Ray server can support any combination of these topologies, which are shown in [FIGURE 7-1](#).

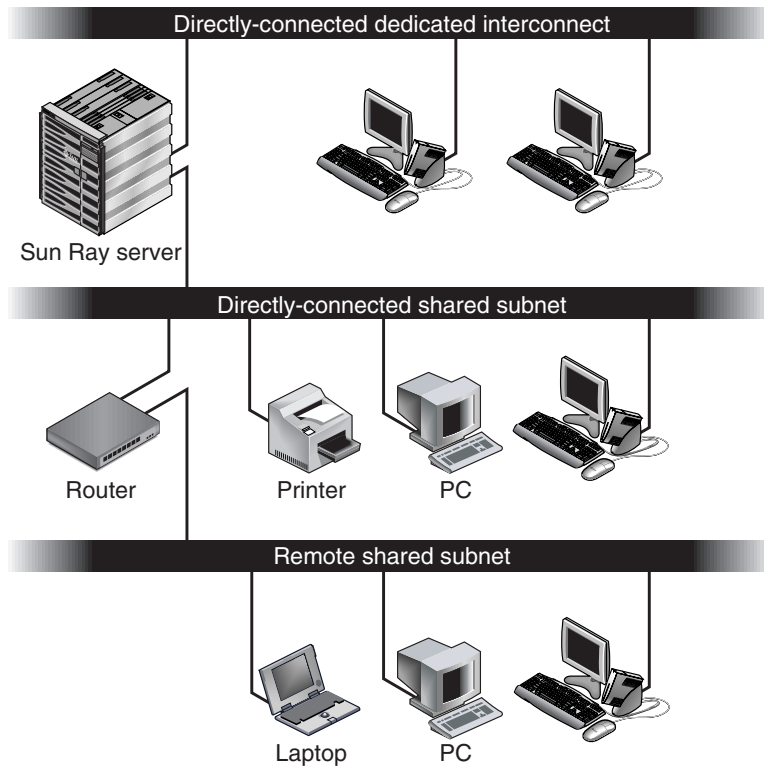

**FIGURE 7-1** Network Topologies for Sun Ray DTU Deployment

---

**Note** – Sun Ray traffic on shared networks is potentially more exposed to an eavesdropper than traffic on a dedicated Sun Ray interconnect. Modern switched network infrastructures are far less susceptible to snooping activity than earlier shared technologies, but to obtain additional security the administrator may choose to activate Sun Ray's encryption and authentication features. These capabilities are discussed in [“Encryption and Authentication” on page 81](#).

---

## Directly-Connected Dedicated Interconnect

The *directly-connected dedicated interconnect*—often referred to simply as an interconnect—places DTUs on subnets that are:

- directly connected to the Sun Ray server (that is, the server has a network interface connected to the subnet).
- devoted entirely to carrying Sun Ray traffic. Prior to the release of Sun Ray Server Software 2.0, this was the only officially supported Sun Ray topology.

The Sun Ray server, which guarantees the delivery of the full set of DTU configuration parameters, is always used to provide DHCP service for a dedicated interconnect.

## Directly-Connected Shared Subnet

Sun Ray Server Software now supports DTUs on a *directly-connected shared subnet*, in which:

- the Sun Ray server has a network interface connected to the subnet.
- the subnet may carry a mix of Sun Ray and non-Sun Ray traffic.
- the subnet is generally accessible to the enterprise intranet.

On a directly-connected shared subnet, DHCP service can be provided by the Sun Ray server, or some external server, or both. Since the Sun Ray server can see broadcast DHCP traffic from the DTU, it can participate in DTU initialization without requiring a DHCP Relay Agent.

## Remote Shared Subnet

Sun Ray Server Software now also supports DTUs on a *remote shared subnet*. On a remote shared subnet:

- a Sun Ray server does not have a network interface connected to the subnet.
- the subnet can carry a mix of Sun Ray and non-Sun Ray traffic.
- all traffic between the server and the DTU flows through at least one router.
- the subnet is generally accessible to the enterprise intranet.

On a remote shared subnet, DHCP service can be provided by the Sun Ray server, by some external server, or by both. For DHCP service on the Sun Ray server to participate in DTU initialization, a DHCP Relay Agent must be configured on the remote subnet, where it collects DHCP broadcast traffic and forwards it to the Sun Ray server.

---

# Network Configuration Tasks

The addition of directly-connected and remote shared subnet support allows DTUs to be deployed virtually anywhere on the enterprise intranet, subject only to the provision of DHCP service and a sufficient quality of service between the DTU and the Sun Ray server.

The following sections explain how to configure a network to support these scenarios:

- [Deployment on a Directly-Connected Dedicated Interconnect](#)
- [Deployment on a Directly-Connected Shared Subnet](#)
- [Deployment on a Remote Subnet](#)

[FIGURE 7-2](#) shows the overall topology and configuration tasks.<sup>3</sup>

## Preparing for Deployment

Before deploying a DTU onto any subnet, the administrator must answer three questions:

1. From which DHCP server will DTUs on this subnet get their basic IP networking parameters?
2. From which DHCP server will DTUs on this subnet get additional configuration parameters to support features such as firmware download?
3. How will DTUs on this subnet locate their Sun Ray server?

The answers to these questions determine what configuration steps will let DTUs placed on this subnet initialize themselves and offer Sun Ray sessions to users.

The following sections present examples of DTU deployment on the directly-connected dedicated interconnect A, the directly-connected shared subnet B, and the remote shared subnets C and D shown in [FIGURE 7-2](#).

---

3. The /24 suffix in IP addresses indicates the use of Classless Inter Domain Routing (CIDR) notation, which is documented in IETF RFCs 1517, 1518, and 1519

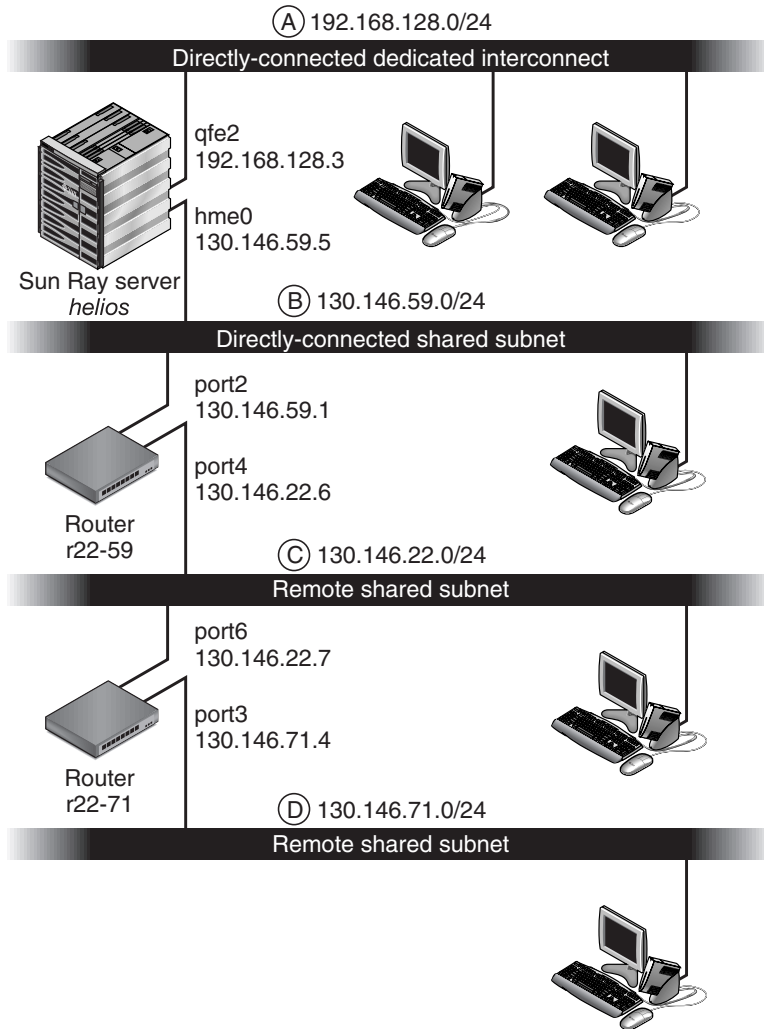

**FIGURE 7-2** Sun Ray Network Topology

## Deployment on a Directly-Connected Dedicated Interconnect

Subnet A in [FIGURE 7-2](#) is a directly-connected dedicated interconnect. Its subnet will use IP addresses in the range 192.168.128.0/24. The Sun Ray server named *helios* is attached to the interconnect through its `qfe2` network interface, which will be assigned the IP address 192.168.128.3.

In an interconnect scenario, the DHCP service on the Sun Ray server always provides both basic networking parameters and additional configuration parameters to the DTU. The answers to the three pre-deployment questions are:

1. From which DHCP server will DTUs on this subnet get their basic IP networking parameters?

*On a directly-connected dedicated interconnect, basic networking parameters are always supplied by the DHCP service on the Sun Ray server.*

2. From which DHCP server will DTUs on this subnet get additional configuration parameters to support features such as firmware download?

*On a directly-connected dedicated interconnect, additional configuration parameters are always supplied by the DHCP service on the Sun Ray server.*

3. How will DTUs on this subnet locate their Sun Ray server?

*On a directly-connected dedicated interconnect, the DTU is always notified of the location of the Sun Ray server through an additional configuration parameter supplied in Step 2.*

## Directly-Connected Dedicated Interconnect: Example

This is an example of DHCP service for the directly-connected dedicated interconnect A shown in [FIGURE 7-2](#).

- 1. Configure the Sun Ray server to provide both basic and additional parameters to the interconnect.**

Use the `utadm -a ifname` command to configure DHCP service for DTUs on an interconnect. In this example, the interconnect is attached through interface `qfe2`, so the appropriate command is:

```
# /opt/SUNWut/sbin/utadm -a qfe2
### Configuring /etc/nsswitch.conf
### Configuring Service information for Sun Ray
### Disabling Routing
### configuring qfe2 interface at subnet 192.168.128.0
Selected values for interface "qfe2"
  host address:          192.168.128.1
  net mask:              255.255.255.0
  net address:          192.168.128.0
  host name:             helios-qfe2
  net name:              SunRay-qfe2
  first unit address:   192.168.128.16
  last unit address:    192.168.128.240
  auth server list:     192.168.128.1
  firmware server:     192.168.128.1
  router:               192.168.128.1
Accept as is? ([Y]/N): n
```

```

new host address: [192.168.128.1] 192.168.128.3
new netmask: [255.255.255.0]
new host name: [helios-qfe2]
Do you want to offer IP addresses for this interface? ([Y]/N):
new first Sun Ray address: [192.168.128.16]
number of Sun Ray addresses to allocate: [239]
new auth server list: [192.168.128.3]
To read auth server list from file, enter file name:
Auth server IP address (enter <CR> to end list):
If no server in the auth server list responds, should an
auth server be located by broadcasting on the network? ([Y]/N):
new firmware server: [192.168.128.3]
new router: [192.168.128.3]
Selected values for interface "qfe2"
  host address:          192.168.128.3
  net mask:              255.255.255.0
  net address:          192.168.128.0
  host name:             helios-qfe2
  net name:              SunRay-qfe2
  first unit address:   192.168.128.16
  last unit address:    192.168.128.254
  auth server list:     192.168.128.3
  firmware server: 1    192.168.128.3
  router:                192.168.128.3
Accept as is? ([Y]/N):
### successfully set up "/etc/hostname.qfe2" file
### successfully set up "/etc/inet/hosts" file
### successfully set up "/etc/inet/netmasks" file
### successfully set up "/etc/inet/networks" file
### finished install of "qfe2" interface
### Building network tables - this will take a few minutes
### Configuring firmware version for Sun Ray
    All the units served by "helios" on the 192.168.128.0
    network interface, running firmware other than version
    "2.0_37.b,REV=2002.12.19.07.46" will be upgraded at their
    next power-on.
### Configuring Sun Ray Logging Functions
DHCP is not currently running, should I start it? ([Y]/N):
### started DHCP daemon
#

```

In this example, the default values initially suggested by utadm were not appropriate. (Specifically, the suggested value for the server's IP address on the interconnect was not the desired value.) The administrator replied **n** to the first Accept as is? prompt and was given the opportunity to provide alternative values for the various parameters.



## 2. Restart Sun Ray services on the Sun Ray server.

Once the `utadm` command has completed, issue a `utrestart` command to fully activate Sun Ray services on the newly-defined interconnect:

```
# /opt/SUNWut/sbin/utrestart
Resetting servers... messages will be logged to /var/opt/SUNWut/log/messages.
```

## Deployment on a Directly-Connected Shared Subnet

Subnet B in [FIGURE 7-2](#) is a directly-connected shared subnet that uses IP addresses in the range `130.146.59.0/24`. The Sun Ray server *helios* is attached to the interconnect through its `hme0` network interface, which has been assigned the IP address `130.146.59.5`. The answers to the three pre-deployment questions are:

1. From which DHCP server will DTUs on this subnet get their basic IP networking parameters?

*In a shared subnet scenario, you must choose whether a DHCP service on the Sun Ray server or some external DHCP service will provide the DTU with basic network parameters. If the enterprise already has a DHCP infrastructure that covers this subnet, it probably supplies basic network parameters. If no such infrastructure exists, configure the Sun Ray server to provide basic network parameters.*

2. From which DHCP server will DTUs on this subnet get additional configuration parameters to support features such as firmware download?

*The administrator must choose whether to supply additional configuration parameters to the DTU and, if so, whether to use a DHCP service on the Sun Ray server or some external DHCP service for this purpose. On a directly connected shared subnet, it is possible to deploy DTUs without providing additional parameters at all, but since this deprives the DTU of a number of features, including the ability to download new firmware, it is generally undesirable.*

*Administrators of an already established DHCP infrastructure may be unable or unwilling to reconfigure that infrastructure to provide additional Sun Ray configuration parameters, so it is usually more convenient to have the Sun Ray server provide these parameters. Even when the established infrastructure is capable of delivering the additional parameters, it may be desirable to have the Sun Ray server provide them. This enables SRSS commands to be used to manage the values of the additional configuration parameters when those values need to be changed in response to software upgrades or patch installations on the Sun Ray server. For instance, a patch that delivers new DTU firmware could automatically update the firmware version string that is delivered to the DTU. However, if the firmware version parameter is supplied by some external DHCP*

*service, an administrator must manually edit the firmware version parameter string in the external DHCP configuration rules to reflect the new firmware version delivered by the patch. This activity is time-consuming and error-prone, as well as unnecessary.*

3. How will DTUs on this subnet locate their Sun Ray server?

*Use one of the optional additional configuration parameters to report the location of the Sun Ray server to the DTU. If additional configuration parameters are not supplied to the DTU at all, the DTU has no indication of the location of any Sun Ray server. In these circumstances, the DTU attempts to discover the location of a Sun Ray server by using a broadcast-based mechanism. However, the DTUs broadcast packets propagate only on the local subnet, so, in the case of a remote subnet, the broadcast cannot reach the Sun Ray server, and contact cannot be established.*

The following examples illustrate two configurations of the directly connected shared subnet. In the first example, the Sun Ray server delivers both basic networking parameters and additional parameters. In the second example, an external DHCP service supplies basic networking parameters, and no additional parameters are provided to the DTU, which must establish contact with the Sun Ray server through its local subnet broadcast discovery mechanism.

The most likely case, where an external DHCP service provides basic networking parameter and the Sun Ray server provides additional parameters, is illustrated by an example in “Deployment on a Remote Subnet.”

## Directly-Connected Shared Subnet: Example 1

In this example, the answers to the three pre-deployment questions are:

1. From which DHCP server will DTUs on this subnet get their basic IP networking parameters?

*From the Sun Ray server.*

2. From which DHCP server will DTUs on this subnet get additional configuration parameters to support features such as firmware download?

*From the Sun Ray server.*

3. How will DTUs on this subnet locate their Sun Ray server?

*The DTUs will be informed of the location of the Sun Ray server through an additional configuration parameter delivered in Step 2.*

## 1. Configure the Sun Ray server to provide both basic and additional parameters to the shared subnet.

DHCP service for DTUs on a shared subnet is configured through the `utadm -A subnet` command. In this example, the shared subnet has network number `130.146.59.0`, so the appropriate command is `utadm -A 130.146.59.0`:

```
# /opt/SUNWut/sbin/utadm -A 130.146.59.0
Selected values for subnetwork "130.146.59.0"
  net mask:                255.255.255.0
  no IP addresses offered
  auth server list:        130.146.59.5
  firmware server:         130.146.59.5
  router:                  130.146.59.1
Accept as is? ([Y]/N): n
netmask: 255.255.255.0 (cannot be changed - system defined netmask)
Do you want to offer IP addresses for this subnet? (Y/[N]): y
new first Sun Ray address: [130.146.59.4] 130.146.59.200
number of Sun Ray addresses to allocate: [55] 20
new auth server list:      [130.146.59.5]
To read auth server list from file, enter file name:
Auth server IP address (enter <CR> to end list):
If no server in the auth server list responds, should an
auth server be located by broadcasting on the network? ([Y]/N):
new firmware server:      [130.146.59.5]
new router:                [130.146.59.1]
Selected values for subnetwork "130.146.59.0"
  net mask:                255.255.255.0
  first unit address:       130.146.59.200
  last unit address:        130.146.59.219
  auth server:              130.146.59.5
  firmware server:          130.146.59.5
  router:                   130.146.59.1
  auth server list:         130.146.59.5
Accept as is? ([Y]/N):
### Building network tables - this will take a few minutes
### Configuring firmware version for Sun Ray
All the units served by "helios" on the 130.146.59.0
network interface, running firmware other than version
"2.0_37.b,REV=2002.12.19.07.46" will be upgraded at
their next power-on.
### Configuring Sun Ray Logging Functions
### stopped DHCP daemon
### started DHCP daemon
#
```

The default values initially suggested by `utadm` were not appropriate. Specifically, this server would not have offered any IP addresses on the `130.146.59.0` subnet because `utadm` assumes that basic networking parameters, including IP addresses, are provided by some external DHCP service when the DTU is located on a shared subnet. In this example, however, the Sun Ray server is required to provide IP addresses, so the administrator replied `n` to the first `Accept as is?` prompt and was given the opportunity to provide alternative values for the various parameters. Twenty IP addresses, starting at `130.146.59.200`, were made available for allocation to DHCP clients on this subnet.

## 2. Restart Sun Ray services on the Sun Ray server.

Once the `utadm` command has completed, issue a `utrestart` command to fully activate Sun Ray services on the shared subnet:

```
# /opt/SUNWut/sbin/utrestart
Resetting servers... messages will be logged to /var/opt/SUNWut/log/messages.
```

## Directly-Connected Shared Subnet: Example 2

In this example, the answers to the three pre-deployment questions are:

1. From which DHCP server will DTUs on this subnet get their basic IP networking parameters?

*From an external DHCP service.*

2. From which DHCP server will DTUs on this subnet get additional configuration parameters to support features such as firmware download?

*The DTUs will not be supplied with additional parameters.*

3. How will DTUs on this subnet locate their Sun Ray server?

*By using the local subnet broadcast discovery mechanism.*

In this example, the Sun Ray server does not participate in DTU initialization at all. Why, then, are configuration steps required on the Sun Ray server? The Sun Ray server responds by default only to DTUs located on directly connected dedicated interconnects. It responds to DTUs on shared subnets only if the `utadm -L on` command has been executed. Running the `utadm -A subnet` command to activate DHCP on the Sun Ray server for a shared subnet, as in this example, implicitly executes `utadm -L on`. If `utadm -A subnet` has not been run, the administrator must run `utadm -L on` manually to allow the server to offer sessions to DTUs on the shared subnet.

### 1. Configure the external DHCP service.

Determining how to configure the external DHCP infrastructure to provide basic networking parameters to the DTUs on this subnet is beyond the scope of this document. Bear in mind:

- If the external DHCP service does not have its own direct connection to this subnet, the administrator must configure a DHCP Relay Agent to deliver DHCP traffic on this subnet to the external DHCP service. The most likely location for such a Relay Agent would be on a router in this subnet, in this case the router named `r22-59` in [FIGURE 7-2](#). For a brief introduction to this topic refer to “[DHCP Relay Agent](#)” on [page 88](#).
- An existing external DHCP service may need to have its IP address allocation for this subnet increased in order to support the new DTUs. (This applies whenever additional DHCP clients are placed on a subnet.) It might also be desirable to reduce the lease time of addresses on this subnet so that addresses become eligible for reuse quickly.

### 2. Configure the Sun Ray server to accept DTU connections from shared subnets.

Run `utadm -L on`:

```
# /opt/SUNWut/sbin/utadm -L on
### Turning on Sun Ray LAN connection
NOTE: utrestart must be run before LAN connections will be allowed
```

### 3. Restart Sun Ray services on the Sun Ray server.

Once the `utadm` command has completed, issue a `utrestart` command to fully activate Sun Ray services on the shared subnet::

```
# /opt/SUNWut/sbin/utrestart
Resetting servers... messages will be logged to /var/opt/SUNWut/log/messages.
```

## Deployment on a Remote Subnet

Subnets C and D in [FIGURE 7-2](#) are remote shared subnets.

Subnet C uses IP addresses in the range `130.146.22.0/24`. Subnet D uses IP addresses in the range `130.146.71.0/24`. The Sun Ray server named *helios* has no direct attachment to either of these subnets; it is this characteristic that defines them as remote. The answers to the three pre-deployment questions are:

1. From which DHCP server will DTUs on this subnet get their basic IP networking parameters?

*In a shared subnet scenario, the administrator must choose whether a DHCP service on the Sun Ray server or some external DHCP service will provide the DTU with basic network parameters.*

*If the enterprise already has a DHCP infrastructure that covers this subnet, it probably supplies basic network parameters. If no such infrastructure exists, configure the Sun Ray server to provide basic network parameters.*

2. From which DHCP server will DTUs on this subnet get additional configuration parameters to support features such as firmware download?

*The administrator must choose whether additional configuration parameters will be supplied to the DTU, and if so whether they will be supplied by a DHCP service on the Sun Ray server or by some external DHCP service.*

*Administrators of an established DHCP infrastructure may be unable or unwilling to reconfigure it to provide additional Sun Ray configuration parameters, so it is usually more convenient to have the Sun Ray server provide them.*

*Even when the established infrastructure is capable of delivering the additional parameters, it may be desirable to have the Sun Ray server provide them. This enables you to use Sun Ray Server Software commands to manage the values of the additional configuration parameters, when those values need to be changed in response to software upgrades or patch installations on the Sun Ray server. For instance, a patch that delivers new DTU firmware could automatically update the firmware version string delivered to the DTU. However, if the firmware version parameter is supplied by some external DHCP service, an administrator must manually edit the firmware version parameter string in the external DHCP configuration rules to reflect the new firmware version delivered by the patch. This kind of activity is time-consuming and error-prone as well as unnecessary.*

3. How will DTUs on this subnet locate their Sun Ray server?

*Use one of the optional additional configuration parameters to report the location of the Sun Ray server to the DTU. If additional configuration parameters are not supplied to the DTU at all, the DTU cannot locate a Sun Ray server, so it tries to discover the location of a Sun Ray server by using a broadcast-based mechanism. However, the DTUs broadcast packets propagate only on the local subnet; they cannot reach a Sun Ray server located on a remote subnet, and cannot establish contact.*

The next two examples illustrate representative remote shared subnet configurations. In the first example, an external DHCP service provides basic networking parameters, and the Sun Ray server provides additional parameters. This is by far the most likely configuration for a Sun Ray deployment in an enterprise that has an established DHCP infrastructure.

In the second example, basic networking parameters and a bare minimum of additional parameters—just enough to enable the DTU to contact a Sun Ray server—are supplied by an external DHCP. In this case, it is the DHCP service in a Cisco router. This scenario is less than ideal.

No firmware parameters are delivered to the DTU, so it cannot download new firmware. The administrator must make some other arrangement to provide the DTU with new firmware, for instance, by rotating it off this subnet periodically onto an interconnect or onto some other shared subnet where a full set of additional configuration parameters is offered.

---

**Note** – For examples of shared subnet deployments in which both basic networking parameters and additional parameters are delivered by the Sun Ray server and basic networking parameters are supplied by an external DHCP service (with no additional DTU parameters provided), see [“Directly-Connected Shared Subnet” on page 90](#).

---

## Remote Shared Subnet: Example 1

In this example, in which DTUs are deployed on subnet C in [FIGURE 7-2](#), the answers to the three pre-deployment questions are:

1. From which DHCP server will DTUs on this subnet get their basic IP networking parameters?

*From an external DHCP service.*

2. From which DHCP server will DTUs on this subnet get additional configuration parameters to support features such as firmware download?

*From the Sun Ray server.*

3. How will DTUs on this subnet locate their Sun Ray server?

*The DTUs will be informed of the location of the Sun Ray server through an additional configuration parameter delivered in Step 2.*

Use the `utadm -A subnet` command as follows to configure DHCP service for DTUs on a shared subnet.

### 1. Configure the external DHCP service.

Determining how to configure the external DHCP infrastructure to provide basic networking parameters to the DTUs on this subnet is beyond the scope of this document. Bear in mind:

- If the external DHCP service does not have its own direct connection to this subnet, the administrator must configure a DHCP Relay Agent to deliver DHCP traffic on this subnet to the external DHCP service. The most likely location for such a Relay Agent would be on a router in this subnet, in this case the router named `r22-59` in [FIGURE 7-2](#). For a brief introduction to this topic refer to [“DHCP Relay Agent” on page 88](#).

- An existing external DHCP service may need to have its IP address allocation increased for this subnet to support the new DTUs. (This applies whenever additional DHCP clients are placed on a subnet.) It might also be desirable to reduce the lease time of addresses on this subnet so that addresses become eligible for re-use quickly.

## 2. Arrange to deliver DHCP traffic to the Sun Ray server.

Because the Sun Ray server does not have its own direct connection to this subnet, the administrator must configure a DHCP Relay Agent to deliver the subnet's DHCP traffic to the Sun Ray server. The most likely location for such a Relay Agent would be on a router in this subnet, in this case the router named `r22-59` in [FIGURE 7-2](#). For a brief introduction to this topic refer to ["DHCP Relay Agent" on page 88](#).

If `r22-59` is running the Cisco IOS, the `ip helper-address` command can be used to activate its DHCP Relay Agent to relay DHCP broadcasts from its 10/100 Ethernet port number 4 to the Sun Ray server at `130.146.59.5`.

```
r22-59> interface fastethernet 4
r22-59> ip helper-address 130.146.59.5
r22-59>
```

If the external DHCP service also lacks a connection to this subnet, configure a DHCP Relay Agent to forward requests from the DTU to:

- The external DHCP service (so that the DTU can obtain basic networking parameters)
- The DHCP service on the Sun Ray server (so that the DTU can obtain additional parameters)

The Cisco IOS `ip helper-address` command accepts multiple relay destination addresses, so if, for instance, the external DHCP service could be contacted at `130.146.59.2` on subnet B in [FIGURE 7-2](#), the appropriate sequence would be:

```
r22-59> interface fastethernet 4
r22-59> ip helper-address 130.146.59.2 130.146.59.5
r22-59>
```

---

**Note** – Details of the IOS interaction vary according to the specific release of IOS, the model of the router, and the hardware installed in the router.

---



### 3. Configure the Sun Ray server to provide additional parameters to the shared subnet.

Use the `utadm -A subnet` command to configure DHCP service for DTUs on a shared subnet. In this example, the shared subnet has network number 130.146.22.0, so the appropriate command is `utadm -A 130.146.22.0`.

```
# /opt/SUNWut/sbin/utadm -A 130.146.22.0
Selected values for subnetwork "130.146.22.0"
  net mask:                255.255.255.0
  no IP addresses offered
  auth server list:        130.146.59.5
  firmware server:         130.146.59.5
  router:                  130.146.22.1
Accept as is? ([Y]/N): n
new netmask:[255.255.255.0]
Do you want to offer IP addresses for this subnet? (Y/[N]):
new auth server list:      [130.146.59.5]
To read auth server list from file, enter file name:
Auth server IP address (enter <CR> to end list):
If no server in the auth server list responds, should an
auth server be located by broadcasting on the network? ([Y]/N):
new firmware server:       [130.146.59.5]
new router: [130.146.22.1] 130.146.22.6
Selected values for subnetwork "130.146.59.0"
  net mask:                255.255.255.0
  no IP addresses offered
  auth server list:        130.146.59.5
  firmware server:         130.146.59.5
  router:                  130.146.22.6
Accept as is? ([Y]/N):
### Building network tables - this will take a few minutes
### Configuring firmware version for Sun Ray
All the units served by "helios" on the 130.146.22.0
network interface, running firmware other than version
"2.0_37.b,REV=2002.12.19.07.46" will be upgraded at their
next power-on.
### Configuring Sun Ray Logging Functions
### stopped DHCP daemon
### started DHCP daemon
#
```

In this example, the default values initially suggested by `utadm` were not appropriate. Specifically, the default router address to be used by DTUs on this subnet was not correct because `utadm` guesses that the address of the default router for any shared subnet will have a host part equal to 1. This was a *great* guess for the directly-connected subnet B in [FIGURE 7-2](#), but it is not correct for subnet C.

The appropriate router address for DTUs on this subnet is 130.146.22.6 (port 4 of router r22-59), so the administrator replied **n** to the first `Accept as is?` prompt and was given the opportunity to provide alternative values for the various parameters.

#### 4. Restart Sun Ray services on the Sun Ray server.

Once the `utadm` command has completed, issue a `utrestart` command to fully activate Sun Ray services on the shared subnet:

```
# /opt/SUNWut/sbin/utrestart
Resetting servers... messages will be logged to /var/opt/SUNWut/log/messages.
```

## Remote Shared Subnet: Example 2

In this example, deploying DTUs on subnet D in [FIGURE 7-2](#), the answers to the three pre-deployment questions are:

1. From which DHCP server will DTUs on this subnet get their basic IP networking parameters?

*From an external DHCP service.*

2. From which DHCP server will DTUs on this subnet get additional configuration parameters to support features such as firmware download?

*The DTUs will not be supplied with the additional parameters required to support firmware download or to activate other advanced DTU features.*

3. How will DTUs on this subnet locate their Sun Ray server?

*The external DHCP service will supply a single additional parameter to inform the DTU of the location of a Sun Ray server.*

In this example, the Sun Ray server does not participate in DTU initialization at all. Why, then, are configuration steps required on the Sun Ray server? The Sun Ray server responds by default only to DTUs located on directly connected dedicated interconnects. It responds to DTUs on shared subnets only if the `utadm -L on` command has been executed. Running the `utadm -A subnet` command to activate DHCP on the Sun Ray server for a shared subnet, as in this example, implicitly executes `utadm -L on`. If `utadm -A subnet` has not been run, the administrator must run `utadm -L on` manually to allow the server to offer sessions to DTUs on the shared subnet.

#### 1. Configure the external DHCP service.

Determining how to configure the external DHCP infrastructure to provide basic networking parameters to the DTUs on this subnet is beyond the scope of this document. However, for this example, assume that DHCP service is provided by

Cisco IOS-based router r22-71 in [FIGURE 7-2](#), attached to the 130.146.71.0 subnet through its 10/100 Ethernet port 3. This router can be configured to provide basic networking parameters and the location of a Sun Ray server as follows:

```
r22-71> interface fastethernet 3
r22-71> ip dhcp excluded-address 130.146.71.1 130.146.71.15
r22-71> ip dhcp pool CLIENT
r22-71/dhcp> import all
r22-71/dhcp> network 130.146.71.0 255.255.255.0
r22-71/dhcp> default-router 130.146.71.4
r22-71/dhcp> option 49 ip 130.146.59.5
r22-71/dhcp> lease 0 2
r22-71/dhcp> ^Z
r22-71>
```

---

**Note** – Details of the IOS interaction vary according to the specific release of IOS, the model of router and the hardware installed in the router.

---

DHCP option 49, the standard option of the *X Window Display Manager*, identifies 130.146.59.5 as the address of a Sun Ray server. In the absence of `AltAuth` and `Auth-Srvr` vendor-specific options, the DTU tries to find a Sun Ray server by broadcasting on the local subnet. If the broadcasts evoke no response, the DTU uses the address supplied in `t` option of the *X Window Display Manager*—provided that the DTU contains firmware at Sun Ray Server Software 2.0 patch level 114880-01 or later.

---

**Note** – This is an unorthodox use of the option of the *X Window Display Manager*, but in a remote subnet deployment where vendor-specific options can not be delivered, it may be the only way of putting a DTU in touch with a server.

---

## 2. Configure the Sun Ray server to accept DTU connections from shared subnets by running `utadm -L on`.

```
# /opt/SUNWut/sbin/utadm -L on
### Turning on Sun Ray LAN connection
NOTE: utrestart must be run before LAN connections will be allowed
#
```

### 3. Restart Sun Ray services on the Sun Ray server.

Once the `utadm` command has completed, issue a `utrestart` command to fully activate Sun Ray services on the shared subnet:

```
# /opt/SUNWut/sbin/utrestart
Resetting servers... messages will be logged to /var/opt/SUNWut/log/messages.
```

TABLE 7-2 lists the vendor-specific DHCP options that Sun Ray defines and uses.

**TABLE 7-2** Vendor-specific DHCP Options

Parameter Name	Client Class	Option Code	Data Type	Optional/Mandatory	Granularity	Max Count	Comments
AltAuth	SUNW.NewT.SUNW	35	IP	Optional	1	0	List of Sun Ray server IP addresses
AuthSrvr	SUNW.NewT.SUNW	21	IP	Mandatory	1	1	Single Sun Ray server IP addresses
AuthPort	SUNW.NewT.SUNW	22	NUMBER	Optional	2	1	Sun Ray server port
NewTVer	SUNW.NewT.SUNW	23	ASCII	Optional	1	0	Desired firmware version
FWSrvr	SUNW.NewT.SUNW	31	IP	Optional	1	1	Firmware TFTP server IP address
BarrierLevel	SUNW.NewT.SUNW	36	NUMBER	Mandatory	4	1	Firmware Download: barrier level
LogHost	SUNW.NewT.SUNW	24	IP	Optional	1	1	Syslog server IP address
LogKern	SUNW.NewT.SUNW	25	NUMBER	Optional	1	1	Log level for kernel
LogNet	SUNW.NewT.SUNW	26	NUMBER	Optional	1	1	Log level for network
LogUSB	SUNW.NewT.SUNW	27	NUMBER	Optional	1	1	Log level for USB
LogVid	SUNW.NewT.SUNW	28	NUMBER	Optional	1	1	Log level for video
LogAppl	SUNW.NewT.SUNW	28	NUMBER	Optional	1	1	Sun Rat server interface name
Intf	SUNW.NewT.SUN	29	ASCII	Optional	1	0	Sun Ray server interface name
NewTBW		30	NUMBER	Optional	4	1	Bandwidth cap
NewTDispIdx	SUNW.NewT.SUNW	32	NUMBER	Optional	4	1	Obsolete. Do not use.
NewTFlags	SUNW.NewT.SUNW	34	NUMBER	Optional	4	1	Obsolete. Do not use.

The DTU can perform its basic functions even if none of these options are delivered during initialization, but some advanced DTU features do not become active unless certain options are delivered to the DTU. In particular:

- `AltAuth` and `AuthSrvr` indicate the IP addresses of Sun Ray servers. Addresses in the `AltAuth` list are tried in order until a connection is established. Current firmware ignores `AuthSrvr` if `AltAuth` is provided, but it is good practice always to specify `AuthSrvr` for the benefit of old (pre Sun Ray Server Software 1.3) firmware, which does not understand the `AltAuth` option. If neither of these options is supplied, the DTU tries to locate a Sun Ray server by sending broadcasts on the local subnet. If the DTU contains firmware at Sun Ray Server

Software 2.0 patch level 114880-01 or later, it resorts to trying to contact a Sun Ray server at the address supplied in the option of the *X Window Display Manager* if that option has been provided.

- `NewTVer` and `FWSrvr` must both be provided in order for the DTU to attempt a firmware download. `NewTVer` contains the name of the firmware version that the DTU should use. If this name does not match the name of the firmware version that the DTU is actually running, the DTU tries to download the desired firmware from a TFTP server at the address given by `FWSrvr`.
- `LogHost` must be specified in order for the DTU to report messages through the syslog protocol. Reporting thresholds for major DTU subsystems are controlled by the `LogKern`, `LogNet`, `LogUSB`, `LogVid`, and `LogAppl` options.

---

**Note** – The message formats, contents, and thresholds are intended for use only by service personnel and are not documented intentionally.

---

The DHCP Client Class name for all Sun Ray vendor-specific options is `SUNW.NewT.SUNW`. The DTU cites this name in DHCP requests so that the server can respond with the appropriate set of vendor-specific options. This mechanism guarantees that the DTU is not given vendor options defined for some other type of equipment and that other equipment is not given options that are meaningful only to the DTU.

---

## Network Performance Requirements

This section describes the minimal network infrastructure needed to support a Sun Ray implementation.

### Packet Loss

Before version 2.0, Sun Ray Server Software was intolerant of packet losses, so it was recommended that packet loss not exceed 0.1 percent over any extended period. However, because this is often an impractical requirement in local area (LAN) and wide area (WAN) network Sun Ray deployments, the Sun Ray Server Software has been made much more robust in the face of packet loss. The first version of this improved software was released with the first 2.0 patch, with additional improvements in releases supporting low-bandwidth WAN Sun Ray deployments.

In earlier versions, the server tried to avoid packet loss by severely limiting its use of available bandwidth whenever it encountered packet loss. Because random losses are inevitable in a non-dedicated LAN or WAN network environment, this approach put unnecessary limits on performance.

Sun Ray Server Software has always had the capability to detect and recover quickly from such losses, so avoiding them was a matter of policy more than necessity. The new software is less timid and avoids operating at bandwidth levels that create packet losses. Instead, it tries to send data at the highest possible rate that it can without incurring large losses. By design, it sometimes sends data at a rate that is too great for the capacity of the connection between the server and the client, and thus discovers what that capacity is. With very high demand, sustained packet losses of up to 10 percent may sometimes be seen, but the software continues to operate and update the contents of the screen correctly nevertheless.

## Latency

Network latency between any Sun Ray client and its server is an important determinant of the quality of the user experience. The lower the latency, the better; latencies under 50 milliseconds for round trip delay are preferred. However, like familiar network protocols such as TCP, the Sun Ray DTU does tolerate higher latencies, but with degraded performance. Latencies up to 150 milliseconds provide usable, if somewhat sluggish, performance.

## Out-of-Order Packets

DTUs that contain Sun Ray Server Software 2.0 firmware or later can tolerate small occurrences of out-of-order packet delivery, such as might be experienced on an Internet or wide-area intranet connection. Current Sun Ray firmware maintains a reordering queue that restores the correct order to packets when they are received out of order. In releases prior to Sun Ray Server Software 2.0, out-of-order packets were simply discarded.

## Encapsulated Options

For each parameter name, there is a vendor ID, an option code, an option type, and an indication as to whether the parameter is mandatory.



---

# Troubleshooting Tools

## utcapture

The `utcapture` utility connects to the Sun Ray Authentication Manager and reports packet loss statistics and round-trip latency timings for each DTU connected to this server. See the `utcapture` man page to learn more about this command.

## utquery

The `utquery` command interrogates a DTU and displays the DTUs initialization parameters along with the IP addresses of the DHCP services that supplied those parameters. It can be helpful in determining whether a DTU was able to obtain the parameters that were expected in a particular deployment and in determining specific DHCP servers that contributed to the DTUs initialization. See the `utquery` man page to learn more about this command.

## OSD Icons

Sun Ray DTU on-screen display (OSD) icons contain information that can help the administrator understand and debug network configuration problems. The amount of information encoded into the icons has been significantly expanded in the firmware delivered with Sun Ray Server Software. The icon structure and progression are described in detail in [“Troubleshooting and Tuning Tips” on page 195](#). Recent updates to Sun Ray DTU firmware include OSD icons that are larger and easier to read than previous versions. The icon message codes and DHCP states they display, however, remain the same and are listed in [TABLE B-1](#) and [TABLE B-2](#) respectively.



---

# Remote Configuration

You can simplify the DHCP configuration of Sun Ray DTUs at remote sites by using the *X Window System Display Manager* option to supply a list of available Sun Ray servers. This eliminates the need for Sun Ray vendor options as well as the need to forward DHCPINFORM requests to a Sun Ray server.

For a more complete treatment of network configuration, including DHCP and vendor-specific options, see [TABLE 7-1](#) and [TABLE 7-2](#).

A sample DHCP configuration for a Cisco IOS-based router is shown below:

```
ip dhcp excluded-address 129.149.244.161
ip dhcp pool CLIENT
    import all network 129.149.244.160 255.255.255.248
    default-router 129.149.244.161
    option 26 hex 0556
    option 49 ip 10.6.129.67 129.146.58.136
    lease 0 2
```

Option 49, the *X Window System Display Manager* option, lists IP addresses 10.6.129.67 and 129.146.58.136 as Sun Ray servers. The Sun Ray DTU tries to connect to those servers when it receives a DHCP response from the router. Option 26 sets the Maximum Transmission Unit (MTU) for the Sun Ray connections, in this case 1366 bytes rather than the default Ethernet MTU of 1500 bytes. This is necessary to allow space for the IPsec headers to implement a virtual private network (VPN) connection.

DHCP service, either directly from an ISP or from a home firewall, is also required, to give the router its IP address behind the firewall.

The router's WAN port either plugs directly into the DSL/Cable modem<sup>4</sup> or into the home firewall/gateway. The Sun Ray DTU then plugs into one of the four LAN ports on the router. If the router has been configured to supply DHCP parameters to the Sun Ray DTU, it will tell the DTU to try to connect to the appropriate Sun Ray server.

The router should bring up a VPN tunnel when it is plugged in; it should always be on. Each router should be connected to the VPN gateway and programmed with a user name based on an employee's ID and a random password. The VPN gateway

---

4. IA VPN router plugged directly into the DSL or Cable modem can be connected only to a Sun Ray DTU.

should be configured to allow only Sun Ray traffic to pass, and only to a limited number of hosts, so that users cannot connect anything else to the LAN side of the router and then connect into the corporate network. However, users may connect more than one Sun Ray DTU.

---

## Firmware Download

Improvements in the firmware make it easier to bring up a set of Sun Ray DTUs with nothing more than generic DHCP parameters.

- The burden of defining the server list can be shifted to the Domain Name Service (DNS).
- Firmware management can be shifted completely to TFTP.
- If `sunray-config-servers` and `sunray-servers` are defined appropriately by the DNS serving a set of remote Sun Rays DTUs, no extra DHCP parameters are required other than basic network information.

The enhancements include:

1. Incorporation of a DNS client in the firmware, which allows many values to be names rather than IP addresses.
2. Support for DHCP option 66 (TFTP server name) as an alternative to the `FWsrvr` vendor option. This can resolve to a list of IP addresses, one of which is chosen randomly.
3. A new firmware maintenance mechanism creates `*.parms` files in `/tftpboot` (one for each model type), which are read in lieu of using the `NewTVer` DHCP vendor option. Thus, remote firmware upgrades are possible without DHCP access to the `NewTVer` value. The `*.parms` files contain the version, hardware revision, and barrier levels, eliminating unnecessary file reads in cases where the barrier would have prevented writing the firmware to flash. For details on options that can be used to configure the `.parms` files, see `utfwadm(1M)`.
4. Use of a default DNS name for the firmware server when neither option 66 nor `FWsrvr` is given. The name chosen is `sunray-config-servers`. Defining it in DNS gives a way to provide the firmware server address without DHCP options, just DNS servers and domain name.
5. Inclusion of `servers=<server name list>` and `select=<inorder|random>` in the `*.parms` files to allow:
  - specification of a list of server names
  - specification of whether the names should be used in order, or at random

If a name resolves to multiple addresses, then an IP address is chosen according to the select keyword.

6. When neither a server list nor an AltAuth list is given, the default name `sunray-servers` is looked up in DNS, and the list of IP addresses is used in place of the AltAuth list.

In the event of an error in the firmware download, a new set of error messages provides additional information that can be useful in diagnosing and correcting the problem. See [“Firmware Download Diagnostics” on page 209](#).

Also, during DNS lookups, a status line in the OSD icon shows the name being looked up and, if one is found, the IP address.

---

## Routerless VPN Capability

Sun Ray Server Software and the most recent firmware provide a VPN solution for remote users that does not require a separate VPN router. The IPsec capability in the Sun Ray firmware allows the Sun Ray DTU to act as a standalone VPN device. The most commonly used encryption, authentication, and key exchange mechanisms are supported, along with Cisco extensions that allow a Sun Ray DTU to interoperate with the Cisco 3000 family of VPN gateways.

Although digital certificates are not supported, the security model is identical to that of the Cisco software VPN client. Using a common group name and key for the initial (IKE phase one) authentication exchange, the DTU authenticates the user individually with the Cisco `xauth` protocol, either by presenting a fixed user name and password stored in flash or by requiring the entry of a user name and one-time password generated by a token card. See [“Download Configuration” on page 117](#).

---

## Pop-up GUI

The Pop-up Graphical User Interface (Pop-up GUI) is a mechanism that allows the entry of configuration parameters for a Sun Ray DTU from the attached keyboard. Most of these configuration parameters are stored in the DTU’s flash memory. Certain control key combinations are used to invoke this new facility, which provides a tree of menus that can be navigated to set and examine configuration values.

The Pop-up GUI enables several features that require the ability to set and store configuration information on the Sun Ray DTU itself, including:

- Non-DHCP network configuration for standalone operation, when it is impossible to configure local DHCP operation

- Local configuration of Sun Ray specific parameters, such as server list, firmware server, MTU, and bandwidth limits
- DNS servers and domain name for DNS bootstrapping
- PPPoE configuration
- IPsec configuration
- Wireless network configuration (used in Tadpole laptops)

To protect the use of stored authentication information, the VPN configuration includes a PIN entry. This enables two-factor authentication for Sun Ray at Home VPN deployments.

The key combinations used to enter this prompt model are unlikely to be used for other purposes. On a regular Sun keyboard, the key combinations are of the form `Stop-<x>`, where `<x>` is one of the keys listed in [TABLE 7-3](#). On non-Sun (PC) keyboards, use the key combination `Ctrl-Pause-<x>`.

**TABLE 7-3** Prompt Mode Key Codes

Code	Meaning
A	Soft reset (Ctrl-Moon)
C	Clear configuration
N	Show status (3 audio keys)
S or M	Enter main configuration menu
V	Show model, MAC address, and firmware version
W	Enter wireless configuration menu (currently disabled)
Right arrow	Volume up (right arrow)
Left arrow	Volume down (left arrow)
Down arrow	Mute/Unmute

`Stop-M` invokes the main configuration menu.

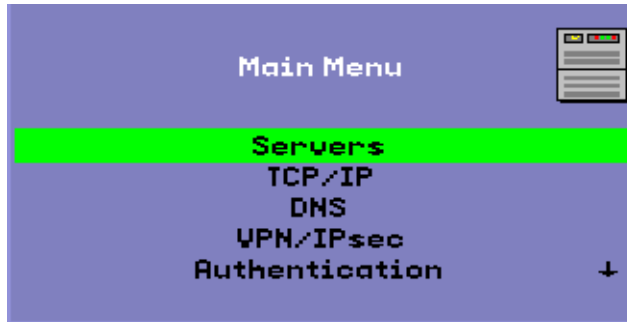

**FIGURE 7-3** Pop-up GUI Main Menu (Part I)

The arrow at the lower right corner indicates that the menu can be scrolled with the Up and Down arrow keys. To clear the contents of an existing entry, use Ctrl-u.



**FIGURE 7-4** Pop-up GUI Main Menu (Part II)

The configuration tree for the Main Menu has the following components:

- Servers
  - Auth list
    - A list of comma-separated server names or IP addresses
  - Firmware Server
    - Name or IP address of firmware/config server
  - Loghost
    - IP address of syslog host
- TCP/IP

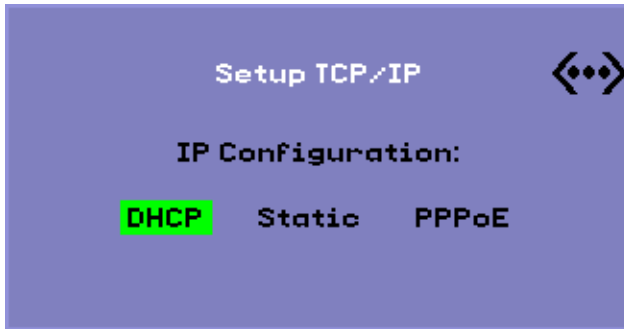

**FIGURE 7-5** DHCP Configuration Selection on the Setup TCP/IP OSD

- Type
  - DHCP, Static, or PPPoE
- DHCP
  - MTU only
- Static
  - IP address, netmask, router, broadcast address, MTU
- PPPoE
  - PAP user name and password, MTU
- DNS
  - Domain name
    - One only
  - DNS Server list
    - List of IP addresses
- VPN/IPsec (Cisco 3000 semantics)

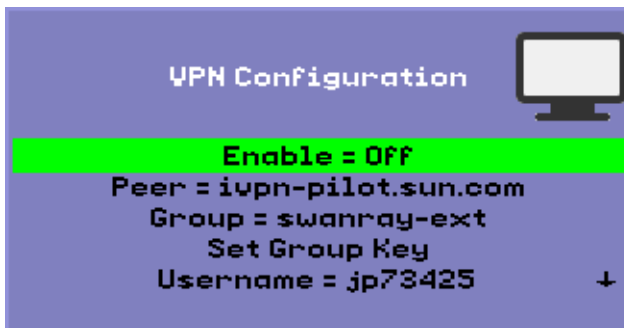

**FIGURE 7-6** Enable VPN Configuration Policy Toggle

- Enable/Disable switch (toggles with Return key (CR))
- Gateway peer (Name or IP address)

- Group name
- Group key
- Xauth user name (if static)
- Xauth password (if static)
- Set PIN
  - If the PIN has been set, the user is prompted for it before a locally stored Xauth user name and password are used.
- Diffie-Hellman group
- IPsec lifetime
- Authentication (for HTTP authentication)
  - Enable/Disable switch
  - Port number
- Security
  - Set password
    - Lock configuration under password control
- Status
  - Version
    - Equivalent to STOP-V
- Advanced
  - Bandwidth limit
    - In bits per second
  - Download Configuration

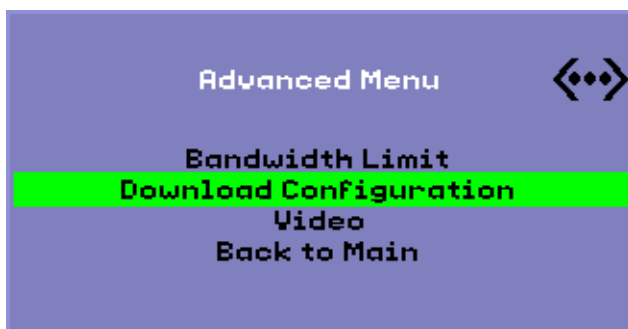

**FIGURE 7-7** Download Configuration Selection

The Download Configuration entry on the Advanced Menu prompts for a server name and file name of a file to be downloaded from the server, in the form `<server>:<filename>`. The default server is the TFTP server value if defined, and the default file name is `config.<MAC>`, where `<MAC>` is the

unit's MAC address in upper-case hexadecimal. This field can be overwritten when selected. Pressing Enter causes the corresponding file to be read and the configuration values parsed and set. For configuration values, see [TABLE 7-4](#).

On success, the user is prompted to save the values, otherwise the previous menu is displayed. No other error indications will be given.

- Set blanking timeout
- Clear Configuration  
(also available with STOP-C)

Some of the menus have an Exit entry, but the Escape key always invokes one level higher than the current menu. Escape at the top level prompts for any changes to be saved or discarded. If changes have been written to the flash, the Escape key resets the DTU.

---

## Remote Loading of Configuration Data

To help avoid error-prone manual entry of configuration data for deployments where pre-configuration is required, you can use the Pop-up GUI to download a configuration to a Sun Ray DTU from a file on a server via TFTP, as indicated in [FIGURE 7-7](#).

The following keywords correspond to configuration values that can be set from Pop-up GUI menus (see [“Pop-up GUI” on page 113](#)). To group items that are logically related, some of the keywords take the form *<family>.<field>*.

**TABLE 7-4** Pop-up GUI Menu Configuration Values

---

VPN/IPsec Submenu	
vpn.enabled	enable toggle
vpn.peer	remote gateway name/IP address
vpn.group	VPN group
vpn.key	VPN key
vpn.user	Xauth user
vpn.passwd	Xauth password
vpn.pin	PIN lock for use of user/passwd
vpn.dhgroup	Diffie-Hellman group to use
vpn.lifetime	Lifetime of IKE connection

---



**TABLE 7-4** (Continued) Pop-up GUI Menu Configuration Values

---

<b>DNS Submenu</b>	
dns.domain	Domain name
dns.servers	Server list (Comma-separated IP addresses)
<b>Servers Submenu</b>	
servers	Sun Ray server
tftpserver	TFTP server
loghost	Syslog host
<b>Security Submenu</b>	
password	Set administrator password
<b>TCP/IP Submenu</b>	
ip.ip	Static IP
ip.mask	Static netmask
ip.bcast	Static broadcast address
ip.router	Static router
ip.mtu	MTU
ip.type	Type of network ("DHCP"   "Static"   "PPPoE")
ip.papname	PPPoE user name
ip.pappasswd	PPPoE password

---

The format of the file is a set of *<key>=<value>* lines, each terminated by a newline character, which are parsed and the corresponding configuration items set (see the sample file below). No whitespace is permitted. Key values are case-sensitive, always lower case, as listed above. To assign a null value, leave the value assigned to a key empty.

```
vpn.enabled=1
vpn.peer=vpn-gateway.sun.com
vpn.group=homesunray
vpn.key=abcabcabc
vpn.user=johndoe
vpn.passwd=xyzzyzxyzy
dns.domain=sun.com
tftpserver=config-server.sun.com
servers=sunray3,sunray4,sunray2
```

**FIGURE 7-8** Sample VPN Configuration File

# Ports and Protocols

TABLE 7-5 and TABLE 7-6 summarize Sun Ray port and protocol usage. In TABLE 7-5, a double-headed arrow in the Flow column indicates the direction of the initial packet. In most cases the DTU initiates the interaction.

Dynamic/TCP ports on the DTU are in the range 32768-65535. Dynamic/UDP ports on the DTU are in the range 4096-65535; however, ALP rendering traffic (ALP-RENDER) always uses a UDP port number greater than 32767 at the DTU.

The range of dynamic/UDP ports on the server is constrained to the range defined by the `utservices-low` and `utservices-high` UDP service definitions, whose default values in `/etc/services` are 40000 and 42000 respectively.

**TABLE 7-5** Sun Ray DTU-to-Server Ports and Protocols

DTU Port	Flow	Protocol	Flow	Server Port	Peer	Importance	Comments
66/UDP (BOOTPC/ DHCP)	--broadcast->> --unicast->>	DHCP	<-broadcast-- <-unicast--	67/UDP (BOOTPS/DH CPS)	DHCP Service	Mandatory	Network and configuration parameter discovery
Dynamic/ UDP	--unicast->>	TFTP	<-unicast--	69/UDP (TFTP)	TFTP Service	Recommended	Firmware download (Since SRSS 3.1: configuration parameter download)
Dynamic/ UDP	--unicast->>	DNS	<-unicast--	53/UDP (domain)	DNS Service	Optional	Introduced in SRSS 3.1 for server name lookups.
514/ UDP (syslog)	--unicast->>	Syslog	(none)	514/UDP (syslog)	Syslog Service	Optional	Event reporting
Dynamic/ UDP	--broadcast->>	ALP- DISCOVERY	<-unicast--	7009/UDP (utauthd-gm)	Sun Ray Server	Optional	On-subnet Sun Ray Server discovery
Dynamic/ TCP	--unicast->>	ALP- AUTH	<-unicast--	7009/TCP (utauthd)	Sun Ray Server	Mandatory	Presence, control, status

**TABLE 7-5** (Continued) Sun Ray DTU-to-Server Ports and Protocols

DTU Port	Flow	Protocol	Flow	Server Port	Peer	Importance	Comments
Dynamic/UDP with port number >= 32768	--unicast-> or --unicast->> when NAT is in use	ALP-RENDER	<<-unicast-- or <-unicast-- when NAT is in use	Dynamic/UDP constrained by utservices-low and utservices-high	Sun Ray Server	Mandatory	On-screen drawing, user input, audio
Dynamic/TCP	-unicast->>	ALP-DEVMGR	<-unicast--	7011/TCP (utdevmgr)	Sun Ray Server	Optional	Device management
7777/TCP	--unicast->	ALP-DEVDATA	<<-unicast--	Dynamic/TCP	Sun Ray Server	Optional	Device data transfer
7013/UDP (utquery)	--unicast->	ALP-QUERY	<<-unicast-- <<-broadcast--	Dynamic/UDP	Any	Optional	utquery support

**TABLE 7-6** Sun Ray Server-to-Server Protocols

Sun Ray Server Port	Protocol	Port	Peer	Notes
	<<-ARP->>		All on subnet	IP-to-MAC mapping
Transient	--SYSLOG/UDP unicast->>	514 (SYSLOG)	Syslog Server	Status reporting, if required
7009 (UTAUTHD)	<<-UTAUTHD-GM/UDP->> broadcast or multicast	7009 (UTAUTHD)	Sun Ray Server	Group discovery, if required
7011 (UTDEVMGRD)	<<-UTDEVMGRD/TCP->>	7011 (UTDEVMGR)	SR Group Member	Device control and status
7008 (UTRCMD)	<<-UTDEVMGRD/TCP->	Privileged	SR Group Member	Remote execution
	<<-ICMP ECHO->		Any	Admin: presence (a bug)
7010 (UTAUTH-CB)	<<-UTAUTH-CB/TCP->	Transient	Any	Admin: control and status
7012 (UTDS)	<<-UTDS/TCP->	Transient	Any	Data store, if required
7007 (UTSESSIOND)	<<-UTSESSION/TCP->	Transient	Any	Session members
7011 (UTDEVMGR)	<<-UTDEVMGR/TCP->	Transient	Any	Device clients
1660 (HTTPS)	<<-HTTPS/TCP->	Transient	Localhost	Web GUI, if configured

**TABLE 7-6** (Continued) Sun Ray Server-to-Server Protocols

<b>Sun Ray Server Port</b>	<b>Protocol</b>	<b>Port</b>	<b>Peer</b>	<b>Notes</b>
1660 (HTTP)	<<-HTTP/TCP->	Transient	Localhost	Web GUI, if configured
7007 (UTSESSIOND)	<<-UTSESSION/TCP->	Privileged	Localhost	Session management
7013 (UTSCREVENTD)	<<-UTSCREVENT/TCP->	Transient	Localhost	Smart card events

# Monitoring the Sun Ray System

---

This chapter describes how to use the Sun Management Center software to monitor the Sun Ray System. Installation instructions for the Sun Management Center are located in [“Installing the SunMC Software” on page 63](#) of the *Sun Ray System Software 4.0 Installation and Configuration Guide*.

Topics include:

- [“Sun Management Center \(SunMC\) Software Features” on page 123](#)
- [“Setting Up the Monitoring Environment” on page 125](#)
- [“Setting Monitoring Guidelines” on page 132](#)
- [“Using Other Monitoring Programs” on page 138](#)
- [“Removing the Sun Ray Module from SunMC” on page 140](#)

---

## Sun Management Center (SunMC) Software Features

The Sun™ Management Center software monitors managed objects in the Sun Ray system. A *managed object* is any object that can be monitored. Sun Ray nodes contain many managed objects. The Create Topology Object dialog box enables you to create a Sun Ray node. If the Sun Ray packages are installed when you create a Sun Ray node, the following managed objects are created by default:

- Sun Ray system
- Sun Ray services
- Failover group
- Interconnect
- Desktops

Each managed object is monitored separately and has independent alarm settings.

For example, in a failover configuration, the entire group as well as any part of the group can be monitored—each server and its load, each interconnect, and each DTU. Sun Management Center software also monitors Sun Ray Server Software daemons that:

- Authenticate users
- Start sessions
- Manage peripheral devices
- Handle DHCP services

After you set an alarm, the Sun Management Center software notifies you when your specified parameter value has been reached. For example, you might want to track the number of DTUs on a server so that you can monitor possible overload scenarios. Other alarms can be set to notify you when a server, interconnect, or DTU goes down or when a daemon is not running.

The three Sun Management Center components ([TABLE 8-1](#)) can be installed on three separate machines.

**TABLE 8-1** Three Components of Sun Management Center Software

Component	Function
Console	Enables you to set and view alarms and to request system information. Requests can be automated or on demand.
Server	Processes requests and passes them on to the appropriate agent. The agent returns the requested information to the server, which then forwards it to the console.
Agents	Monitor the system. Agents return the requested information to the server. These agents, based on SNMP (Simple Network Management Protocol), monitor the status of the <i>managed object</i> (server, interface, or DTU).

Sun Ray system monitoring consists of a set of packages, which are installed as part of Sun Ray Server Software. If you run the Sun Management Center on a non-Sun Ray server, you must add some packages that contain localized messages and icons to the Sun Management Center monitoring server.

This feature interfaces with the Sun Management Center software using SNMP. For information on additional monitoring programs that interact with Sun Management Center software, see [“Using Other Monitoring Programs” on page 138](#).

---

# Additional Sun Management Center Modules

There are other useful Sun Management Center modules available to monitor processes and help tune your Sun Ray system. For example, the Health Monitor module monitors resources on the Sun Ray server so you know when to add memory, swap space, or additional CPUs. The Sun Management Center Process Monitoring module helps identify runaway processes and limit multimedia applications.

---

## Setting Up the Monitoring Environment

After installing the Sun Management Center software, you need to set up your monitoring environment. A default administrative domain is automatically created for you based on the Sun Management Center server component. You need to set a home administrative domain. This domain is displayed whenever the console is started. Next, create the hierarchy of the system you want to monitor. This can be done manually by adding nodes to the administrative domain or by using the Discovery Manager.

### ▼ To Set Up the Monitoring Environment

1. **After installing the Sun Management Center software, start the console on the server that has the console component installed:**

```
# /opt/SUNWsymon/sbin/es-start -c &
```

The login screen is displayed.

2. **Enter your user name and password.**  
Specify the Sun Management Center server.
3. **Click Login.**

The Sun Management Center window is displayed. If this is your first time using the SunMC console, the Set Home Domain window is also displayed.

4. In the Set Home Domain window, highlight the appropriate domain and click Go To.

The panels in the Sun Management Center window are populated.

5. Click Close to dismiss the Set Home Domain window.

## ▼ To Create an Object

1. Expand the Sun Management Center Domains list.

2. Select the domain you plan to add an object to.

The selected domain is displayed.

3. Select Edit -> Create an Object.

The Create Topology Object pop-up window is displayed.

4. On the Node page, enter a Node Label and Description. Then enter the Hostname (server name), IP Address, and Port for the Sun Ray server.

The port entered here must be the same port you configured (entered) during the installation of the Sun Management Center.

## Setting Alarms

Alarms are used to notify you when errors occur or your performance needs to be tuned. Alarms are triggered (tripped) if:

- A server goes down.
- An interconnect is no longer working.
- a DTU is down.

These alarms are set by default, but you can change them. Base a tuning alarm on the number of active sessions on each server in a failover group to determine if one of the servers is overloaded. You set the thresholds that trigger this type of alarm.

## ▼ To Set an Alarm

1. After creating an object, bring up the Details window of the object.



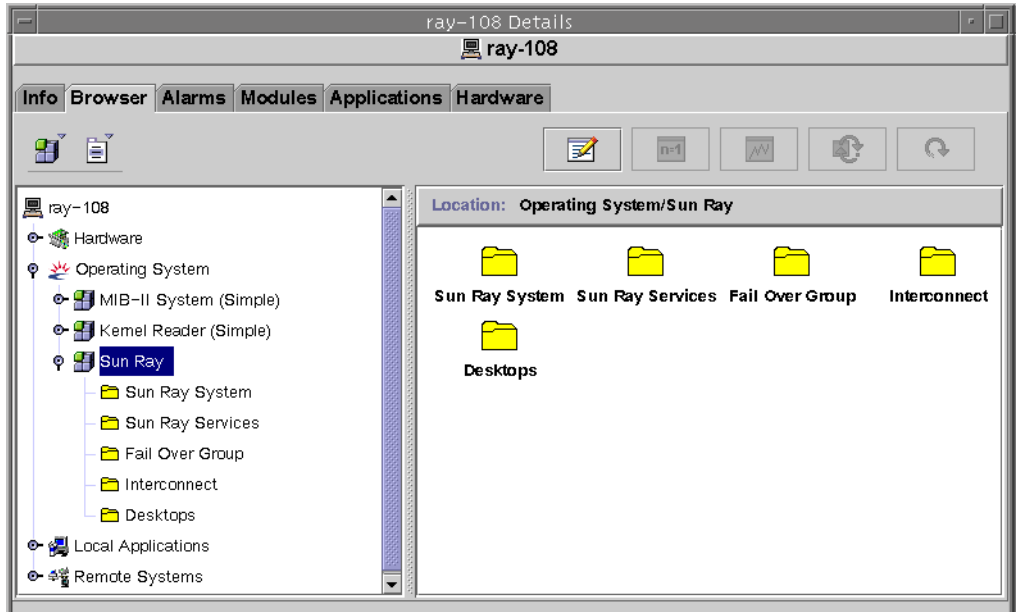

FIGURE 8-1 Sun Management Center Details Window

2. Double-click, for example, Failover Group in the left panel.
3. Right-click the value portion (Status) of the table row.

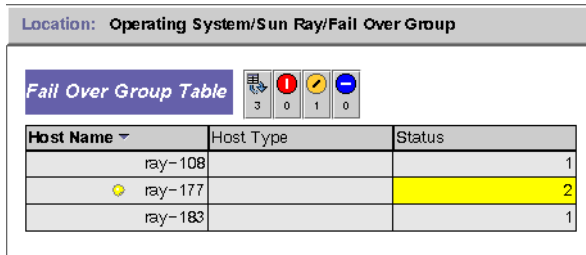

FIGURE 8-2 Example Using the Failover Group Panel

A pop-up menu is displayed.

4. Select Attribute Editor.
5. Select the Alarms tab (See FIGURE 8-3.)

The possible alarm values are:

- Critical Threshold (>)

- Alert Threshold (>)
- Caution Threshold (>)
- Critical Threshold (<)
- Alert Threshold (<)
- Caution Threshold (<)

**6. Supply an appropriate number for the type of alarm that you choose to monitor.**

In this example, the Alert Threshold alarm is set at greater than 1 to notify you when that server in the failover group is down.

**7. Click the Apply button to save the value of the alarm and continue setting other values in the Attribute Editor**

**8. Click the OK button, which saves the value of the alarm and closes the window.**

As soon as you set an alarm it takes effect.

**9. Select the Actions tab and enter an action to perform.**

Here you can also specify an action such as sending email or running a script for each alarm.

**10. Select the Refresh tab to set the number of seconds between pollings.**

The default value is 300 seconds (5 minutes).

**11. Select the History tab to view information about the log file that records monitored values.**

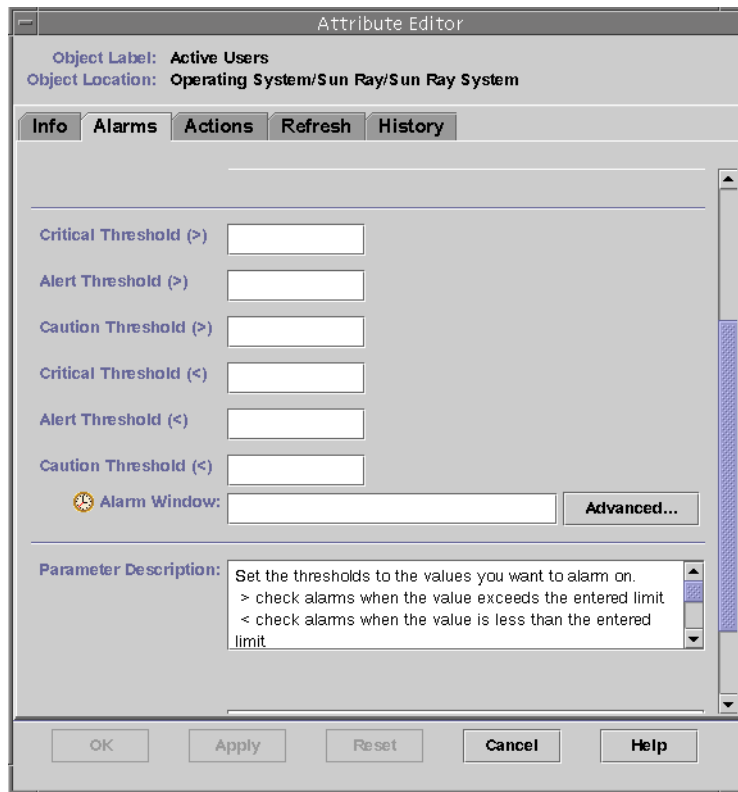

**FIGURE 8-3** Alarm Window

If an alarm is tripped, a critical alarm displays as red, an alert alarm displays as yellow, and a caution displays as blue (see [FIGURE 8-4](#)).

## ▼ To Start Monitoring

1. **Start the Sun Management Center software:**

```
# /opt/SUNWsymon/sbin/es-start -c &
```

A window for the Default domain is displayed.

2. **Log in to the Sun management Center server.**
3. **Double-click the server in either panel.**  
The server Details window is displayed.
4. **Expand the hierarchy in the left or right panel until it displays the level you want.**

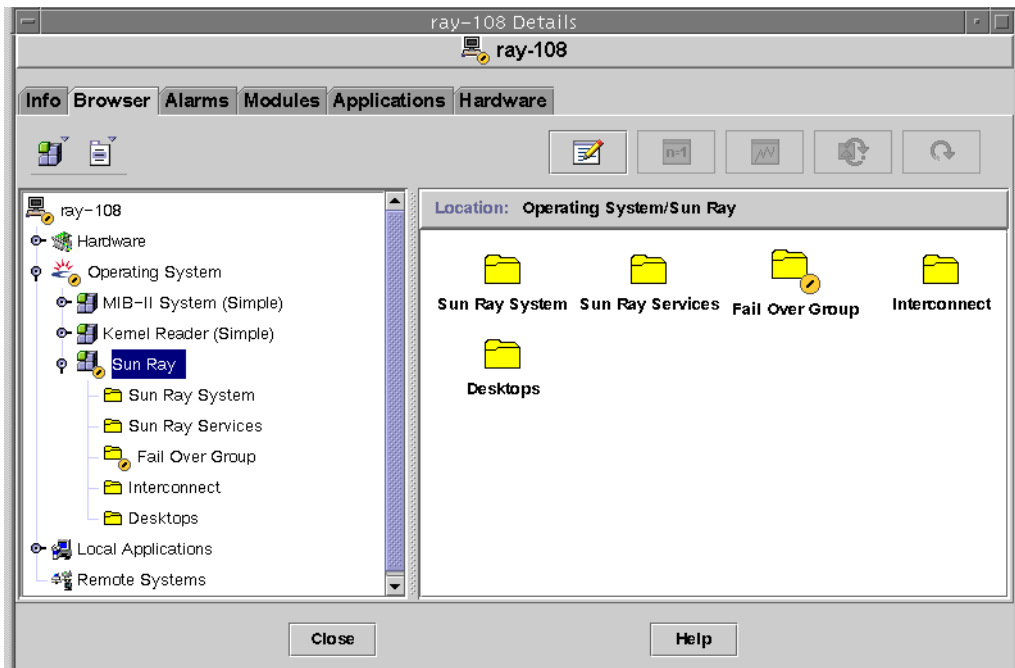

**FIGURE 8-4** Details Window With Alarms

This console Details window shows the hierarchical details of your system. You can immediately see if any alarms have been tripped. An alarm's area and type appear in the left panel as a colored circle with a bar. The Alert alarm also shows up on the title bar by the server node name and at the Operating System, Sun Ray, and Failover Group levels. Double-clicking the area where an alarm icon is present updates the right panel with the detailed information. If you position the mouse pointer over one of the colored circles in either panel, a pop-up window is displayed detailing the alarm information.

If you click the Alarms tab in the Details window, a window is displayed that lists a summary of all the current alarms. When you stop the Sun Ray services (daemons), the alarms display as shown in [FIGURE 8-5](#).

✓ 🚧 ↻ 📄

Last Refresh: Apr 05 16:56:01

Current Page: 1 ⏪ ⏩ ⏴ ⏵

Total Alarms for Object: 12

Severity	Start time	State	Action	Message
🔴	Apr 04 14:05:27	🔔	🚧	Sun Ray utsessiond Instances < 2
🔴	Apr 04 14:05:27	🔔	🚧	Sun Ray utdevmgrd Instances < 2
🔴	Apr 04 14:05:27	🔔	🚧	Sun Ray utseriald Instances < 2
🔴	Apr 04 14:05:27	🔔	🚧	Sun Ray Up Time (1/100ths sec.) Session Manager down
🔴	Apr 04 14:05:27	🔔	🚧	Sun Ray utparalleld Instances < 2
🟡	Apr 04 14:05:26	🔔	🚧	Sun Ray utauthd Status > 1
🟡	Apr 04 14:05:26	🔔	🚧	Sun Ray utsessiond Status > 1
🟡	Apr 04 14:05:26	🔔	🚧	Sun Ray utdevmgrd Status > 1
🟡	Apr 04 14:05:26	🔔	🚧	Sun Ray utseriald Status > 1
🟡	Apr 04 14:05:26	🔔	🚧	Sun Ray utparalleld Status > 1
🟡	Apr 04 14:05:26	🔔	🚧	Sun Ray in?2edhcpd Status > 1
🟡	Apr 04 14:05:26	🔔	🚧	Sun Ray rpc?2ebootparamd Status > 1

**FIGURE 8-5** Alarm Summary Window

The total number of alarms set for the current server object is displayed at the top of the alarm summary window. Critical alarms (red), alert alarms (yellow), and caution alarms (blue) that are tripped are listed below. Details and comments are displayed in the Message column.

Some cells in the table respond to a mouse-over event by displaying a pop-up window called a *Tool Tip window*. This window shows the current status and when it last changed, plus the type of alarm, its value, and when it occurred or when the last alarm was cleared. The Tool Tip time can also be the last time the agent was restarted. For example, on the Sun Ray System panel, a Tool Tip for Up Time (1/100ths sec.) would be:

Clear. Up Time (1/100th sec.) OK Status changed Mar. 6, 15:23:55.

indicating that the server was restarted and the alarm cleared on March 6 at 15:23:55. Similar information is provided for Active Sessions, Desktops, Users, and Total Sessions.

# Setting Monitoring Guidelines

There are five managed objects that you can monitor:

- Sun Ray System—Describes the Sun Ray server and load information
- Sun Ray Services—Describes the Sun Ray daemons on a Sun Ray server
- Failover Group—Lists all the servers in the group
- Interconnect—Lists all the interfaces on a Sun Ray server
- Desktops—Lists all monitored DTUs (desktops) and DTUs that have exceptions that are connected to a Sun Ray server

## Sun Ray System Panel

The Sun Ray System panel displays an overview of your Sun Ray system. From this window you can set specific alarms to monitor the server and its load.

### ▼ To Display the Sun Ray System Panel

- Double-click the Sun Ray System icon in the left panel.

The Operating System/Sun Ray/Sun Ray System panel is populated.

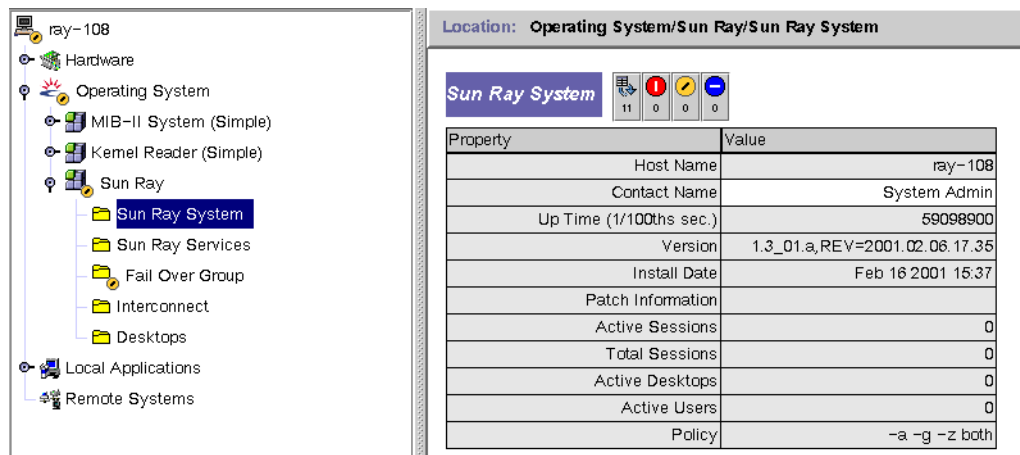

The screenshot shows a management console window. On the left is a tree view of system components. The 'Sun Ray System' folder is selected and highlighted in blue. On the right is a detailed view of the 'Sun Ray System' properties, including a table of key-value pairs.

Property	Value
Host Name	ray-108
Contact Name	System Admin
Up Time (1/100ths sec.)	59098900
Version	1.3_01.a,REV=2001.02.06.17.35
Install Date	Feb 16 2001 15:37
Patch Information	
Active Sessions	0
Total Sessions	0
Active Desktops	0
Active Users	0
Policy	-a -g -z both

FIGURE 8-6 Sun Ray System Panel

## ▼ To Refresh the Sun Ray System Panel

- **Click the refresh button (circular arrow in the upper right corner).**

The entire system panel is refreshed.

The Up Time, session, DTU (desktop), and user information is refreshed periodically based on the number of seconds you set in the Attribute Editor. However, the console is updated only every five minutes unless an alarm occurs. The number of seconds set in the Attribute Editor only changes how soon an alarm is triggered.

---

**Tip** – Do not set the seconds to less than 60. The load interferes with the Sun Ray server performance.

---

In this panel, you set alarms to monitor the status of the server; how many sessions, users, or DTUs are active; and how many total sessions exist.

## ▼ To Set Alarms

1. **Click the Value cell of the Property you want to set an alarm for with the right mouse button.**
2. **Select Attribute Editor.**
3. **Click the Alarms tab.**
4. **Enter a value for each threshold you want to monitor.**
5. **Click OK.**

**TABLE 8-2** Properties on the Sun Ray System Panel

Property	Value
Host Name	Name of server that was queried. This information is obtained when Sun Ray System is selected or on manual refresh.
Contact Name	This information is obtained when Sun Ray System is selected or on manual refresh.
Up Time (measured in hundredths of a second)	Number of hundredths of a second since the last of all the daemons critical to the Sun Ray server was started. A value of 0 means the server is down and an alarm is tripped. The default refresh rate is 300 seconds (five minutes)
Version	List of version, build, and date of build of Sun Ray Server Software. This information is obtained when Sun Ray System is selected or on manual refresh.
Install Date	Date Sun Ray Server Software was installed. This information is obtained when Sun Ray System is selected or on manual refresh.

**TABLE 8-2** Properties on the Sun Ray System Panel (Continued)





Property	Value
Patch Information	List of Sun-Ray-specific patches. This information is obtained when Sun Ray System is selected or on manual refresh.
Active Sessions	Number of sessions based on logged-in sessions with a smart card plugged in, plus sessions for DTUs logged in without smart cards. Set an alarm here to watch for overloading of this server. The default refresh rate is 300 seconds (five minutes).
Total Sessions	Number of active and suspended sessions. The default refresh rate is 300 seconds (five minutes).
Active Desktops	Number of connected DTUs. The default refresh rate is 300 seconds.
Active Users	Number of currently active users. When pseudo-tokens are allowed (this is a policy setting for non-smart card users), this number includes DTUs at the login prompt. The default refresh rate is 300 seconds (five minutes).
Policy	The policy that has been set. This information is obtained when Sun Ray System is selected or on manual refresh.

## Sun Ray Services Panel

The Sun Ray Services panel displays the status of the Sun Ray daemons. If, for example, `utauthd` is not running, all user sessions are disconnected.

On the Sun Ray Services panel, default alarm values are set for the status of each daemon and the number of instances. You can reset them if you want to.

Location: Operating System/Sun Ray/Sun Ray Services

Services Table      
10 0 0 0

Daemon	Status	Started Time	Last Changed	Instances	Description
in.dhcpd	1	1030644821	1030644821	1	DHCP daemon
rpc.bootparamd	1	1030480972	1030480972	1	Net boot parameter daemon
utauthd	1	1030481109	1030481109	1	Auth Manager
utdevmgrd	1	1030481108	1030481108	2	Device Manager
utdsd	1	1030480934	1030480934	1	Datastore daemon
utparalleld	1	1030481108	1030481108	2	Parallel Device daemon
utscreeventd	2	0	0	0	Smartcard Manager
utseriald	1	1030481109	1030481109	2	Serial Device daemon
utsessiond	1	1030481108	1030481108	2	Session Manager
utwsd	1	1030480942	1030480942	1	Web Admin daemon

**FIGURE 8-7** Sun Ray Services (daemons) Panel



The Status values are:

1. The daemon is running;
2. The daemon is down.

Some of the daemons have two instances, corresponding to their two functions: one to listen and one to interact.

---

**Note** – The `utscreventd` daemon does not run unless third-party smart card software is installed, so no alarm is triggered when the `utscreventd` status is 2.

---

## Failover Group Panel

The Failover Group panel displays the topography of your failover group. The panel lists the primary and secondary servers and their status.

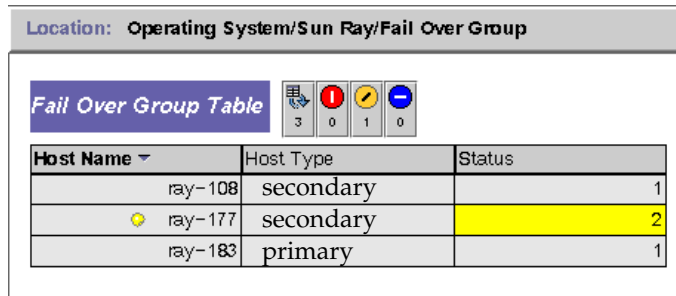

**FIGURE 8-8** Failover Group Panel

If the Status is 1, the server is running. If the Status is 2, the server is down and there is one Alert (yellow) alarm.

## Interconnect Panel

The Interconnect panel lists all the network interfaces usable by the Sun Ray server.

Location: **Operating System/Sun Ray/Interconnect**

**DHCP Table**

Network Name	Available Addresses
SunRay-hme1	73

**Interface Table**

Entry Name	Status	Address	Netmask	Last Packet Seen (1/100ths sec)	Lan Type
hme0	1	192.9.116.108	255.255.255.0	1700	LAN
hme1	1	192.168.128.1	255.255.255.0	1700	

**FIGURE 8-9** Interconnect Panel

The DHCP Table lists the interfaces that are used for the Sun Ray interconnect. Available Addresses lists the number of addresses available for new end users. The alarms that are set here let the system administrator know when the Sun Ray server is running out of addresses to give to users.

The Interface Table lists all the interfaces on the Sun Ray server. The Address is the IP address for the interface. You entered this address as the Net Mask when you first configured your system.

If the Status is 1, the interface is up. If the Status is 2, the interface is down.

## ▼ To Set an Alarm for Running Out of Addresses

1. Click the Available Addresses cell in the DHCP Table using the right mouse button.
2. Select Attribute Editor.
3. Click the Alarms tab.
4. Enter the number of addresses left when an alarm should be tripped.
5. Click OK.

## Desktops Panel

The Desktops panel is where you can select individual DTUs to monitor. The possible values for the status of the DTUs are: 1, running; 2, down; and 3, displaying the green hourglass cursor. The default polling time is 300 seconds (5 minutes).

DTUs can be added and deleted from the Monitored Desktops list.

In a failover group, you can monitor any desktop from any server.

## ▼ To Add a DTU to Be Monitored

1. Click Name using the right mouse button.  
A pop-up menu is displayed.
2. Click Add Row.  
A pop-up window is displayed.
3. In the Add Row window, enter the MAC address of the DTU you want to monitor in the Name field.
4. Click OK.

## ▼ To Delete a DTU to Exclude Monitoring

1. Using the right mouse button, click the cell containing the MAC address.  
A pop-up menu is displayed.
2. Click Delete Row.  
A pop-up window is displayed.
3. Confirm the deletion by clicking Yes on the pop-up window.  
Sample results of polling the Desktops are provided below.

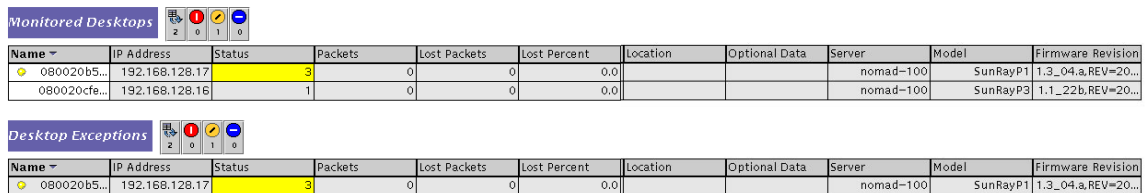

The screenshot shows two tables: 'Monitored Desktops' and 'Desktop Exceptions'. Both tables have columns for Name, IP Address, Status, Packets, Lost Packets, Lost Percent, Location, Optional Data, Server, Model, and Firmware Revision. In the 'Monitored Desktops' table, the first row has a yellow background and a status of 3. In the 'Desktop Exceptions' table, the first row also has a yellow background and a status of 3.

Name	IP Address	Status	Packets	Lost Packets	Lost Percent	Location	Optional Data	Server	Model	Firmware Revision
080020b5...	192.168.128.17	3	0	0	0.0			nomad-100	SunRayP1	1.3_04.a.REV=20...
080020cfe...	192.168.128.16	1	1	0	0.0			nomad-100	SunRayP3	1.1_22b.REV=20...

Name	IP Address	Status	Packets	Lost Packets	Lost Percent	Location	Optional Data	Server	Model	Firmware Revision
080020b5...	192.168.128.17	3	0	0	0.0			nomad-100	SunRayP1	1.3_04.a.REV=20...

FIGURE 8-10 Desktops Panel

TABLE 8-3 describes the information in each column:

TABLE 8-3 Desktop Information

Property	Value
Name	Ethernet or MAC address of the DTU
IP Address	Assigned DHCP address of the DTU
Status	1 running, 2 down, and 3 displaying the green hourglass cursor
Packets	Number of packets received by the DTU
Lost Packets	Number of packets the DTU reported lost

**TABLE 8-3** Desktop Information *(Continued)*

<b>Property</b>	<b>Value</b>
Lost Percent	Percentage of packets lost
Location	Optional field; information supplied by system administrator
Optional Data	Optional field; information supplied by system administrator
Server	Server that owns the DTU
Model	The type of DTU: Sun RayP1 (Sun Ray 1), Sun RayP2 (Sun Ray 100), or Sun RayP3 (Sun Ray 150)
Firmware Revision	List of version, build, and build date

---

## Using Other Monitoring Programs

System administrators using HP OpenView™VPO, Tivoli TMS, or CA Unicenter can also monitor Sun Ray servers. An interoperability interface exists between each of these packages and the Sun Management Center software. These interfaces translate Sun Management Center alarms appropriately so that you are notified when problems arise. These interfaces also enable you to view the server status. Hewlett-Packard provides the interface needed between HP OpenView™VPO and Sun Management Center. Sun provides the interface needed between Sun Management Center and Tivoli TMS or CA Unicenter.

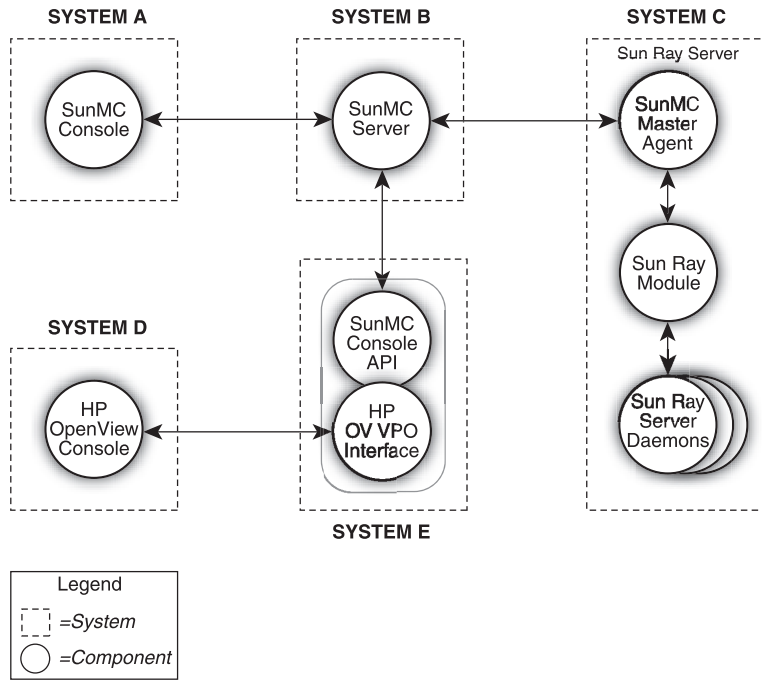

**FIGURE 8-11** Example of Interoperability

In [FIGURE 8-11](#), systems B and E must be Solaris SPARC systems; system C can be either a Solaris SPARC or a Solaris x86 system.

---

# Removing the Sun Ray Module from SunMC

The Sun Ray module is uninstalled automatically when the `utinstall` script uninstalls Sun Ray Server Software. If you are uninstalling the Sun management Center software manually, please remove the Sun Ray module first.

## ▼ To Remove the Sun Ray module

- To unregister the module on the Sun Ray server, type:

```
# /opt/SUNWut/sbin/utsummc -u
```

If the SunMC agent is running, `utsummc` stops and restarts the Sun Management Center agent software.

- To remove the Sun Ray module on the SunMC server, type:

```
# /opt/SUNWut/lib/utsumcinstall -u
```

## Multihead Administration

---

The multihead feature on Sun Ray™ DTUs enables users to control separate applications on multiple displays, also called screens, or *heads*, using a single keyboard and pointer device attached to the primary DTU. Users can also display and control a single application, such as a spreadsheet, on multiple screens. System administrators create multihead groups that can be accessed by users. A multihead group, consisting of between two and 16 DTUs controlled by one keyboard and mouse may be composed of virtually any mix of Sun Ray DTUs, such as Sun Ray 1, Sun Ray 100, Sun Ray 150, Sun Ray 170, and Sun Ray 270, for instance. Each DTU other than the Sun Ray 2FS<sup>1</sup> presents an X screen of the multihead X display.

---

**Note** – For the multihead feature to function properly:

1. You must be in administered mode; therefore, you must run `utconfig` before you run `utmhconfig` and `utmhadm`.
  2. You must enable the multihead policy using either `utpolicy` or the Admin GUI.
  3. Always run `utmhconfig` from a Sun Ray DTU.
- 

**Note** – Regional hotdesking is not enabled for multihead groups.

---

---

1. The Sun Ray 2FS is designed to run a single display across two screens without additional configuration. It utilizes a single frame buffer for two displays, always treating two attached heads as a single, unified display surface to be controlled with a single mouse and keyboard, and always presenting itself to the X server as a single screen.

---

# Multihead Groups

A multihead group is comprised of a set of associated Sun Ray DTUs controlled by a primary DTU to which a keyboard and pointer device, such as a mouse, are connected. This group, which can contain a maximum of 16 DTUs, is connected to a single session.

Unless XINERAMA is enabled (see [“XINERAMA” on page 147](#) for more details), sessions will have a separate CDE toolbar (with separate workspaces) per screen. A window cannot be moved between screens. However, as noted, the Sun Ray 2FS DTU treats two attached screens as a single display, based on a single frame buffer and controlled with a single keyboard and pointer device.

The primary DTU hosts the input devices associated with the session. The remaining DTUs, called the secondaries, provide the additional displays. All peripherals are attached to the primary DTU, and the group is controlled from the primary DTU.

Multihead groups can be created easily by using a smart card to identify the terminals with the `utmhconfig` GUI utility.

---

**Tip** – For best results, run `utmhconfig` only from a DTU.

---

However, if you disconnect the secondary DTUs without deleting the multihead group to which they belong, the screens are not displayed on the single primary DTU. The primary DTU is still part of the multihead group, and the mouse seems to get lost when it goes to the disconnected secondary DTU. To recover from this situation, you can either reconnect the missing DTU, or delete the multihead group using the `utmhconfig` or `utmhadm` command, or you can delete the multihead group, replace the missing DTU, and create a new multihead group that incorporates the replacement DTU.

## Multihead Screen Configuration

A multihead group can have its screens arranged in various configurations. For example, a user can arrange a multihead group of four screens as two rows of two screens (2x2) or as a single row of four screens (4x1). By default, when a user logs into a multihead group, the session uses the number of screens available; the layout, or geometry of these displays is generated automatically. You can use the `-R` option to `utxconfig` to manipulate the automatic geometry, as in the following examples:



- To override the automatic geometry, where geometry is expressed as *columns x rows*:

```
% utxconfig -R geometry
```

- To restore the automatic geometry on the next login:

```
% utxconfig -R auto
```

When the mouse pointer is moved past the edge between two screens, it moves from one screen to the next. The geometry of the multihead group determines which screen is displayed at that moment.

Screen dimensions for the multihead group are automatically set, by default, to the largest supported by the primary DTU. The primary DTU is the one that controls the other DTUs in the group and to which all peripherals are attached.

To override the automatic sizing of screen dimensions, use the `-r` option to `utxconfig`:

- To override automatic sizing, where dimensions are expressed as *width x height* (for example, 1280 x 1024):

```
% utxconfig -r dimensions
```

- To restore automatic sizing behavior on the next login:

```
% utxconfig -r auto
```

- To explicitly choose not to use multiple displays for a session, type:

```
% utxconfig -m off
```

---

**Note** – If explicit screen dimensions are chosen, or if the resolutions of the monitors differ, you may have problems with unwanted on-screen movement called *panning*, or large *black bands* around the visible screen area.

---

# Multihead Screen Display

When the multihead feature is used, a small window indicating the current session on each screen is displayed with the current screen highlighted for easy identification. This window is automatically displayed for users during session creation. For example, the display in “XINERAMA” on page 147 indicates that the user is on the second screen of a three-screen display.

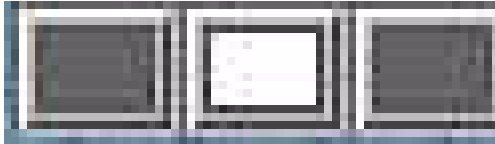

**FIGURE 9-1** The Multihead Screen Display

## Multihead Administration Tool

The administration tool for the multihead feature displays the current multihead groups and enables you to create new groups.

### ▼ To Turn On Multihead Policy From the Command Line

- On the command-line interface, type:

```
# /opt/SUNWut/sbin/utpolicy -a -m -g your_policy_flags
# /opt/SUNWut/sbin/utrestart
```

This enables the multihead policy for the failover group and restarts Sun Ray Server Software with the new policy on the local server without disrupting existing sessions.

---

**Tip** – Issue the `utrestart` command on every server in the failover group.

---

### ▼ To Turn On Multihead Policy Using the Administration Tool

1. Bring up the Administration Tool by typing the following URL into your browser’s location field:

```
http://hostname:1660
```

2. Select Admin from the navigation menu on the left side of the tool.
3. Select Policy.
4. Next to Multihead feature enabled, click the Yes radio button.
5. Click the Apply button.
6. Under Admin in the lefthand menu, select Reset Services.
7. Click the Restart button.

This sets the multihead policy for all servers and restarts Sun Ray Server Software on all servers.

## ▼ To Create a New Multihead Group

1. On the command-line interface, type:

```
# /opt/SUNWut/sbin/utmhconfig
```

2. On the initial screen, click Create New Group.

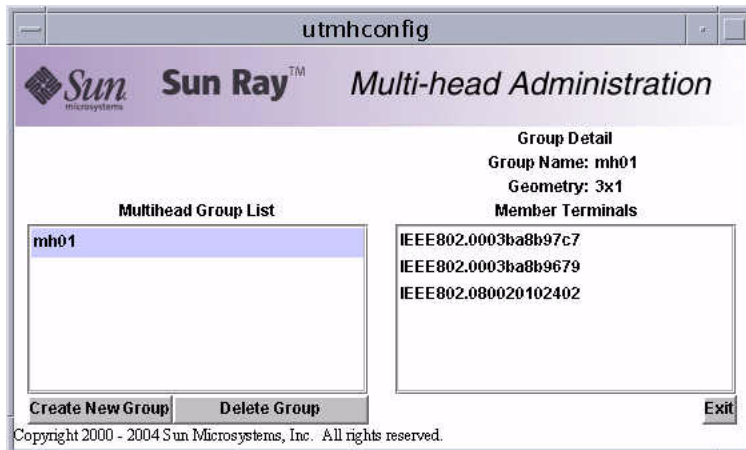

**FIGURE 9-2** utmhconfig GUI Lists Multihead Groups and Details

The Create New Multiheaded Group pop-up dialog box is displayed. The number of rows and the number of columns you enter are displayed as the group geometry when the group has been created.



**FIGURE 9-3** Create New Multiheaded Group Pop-up Dialog Box

**3. Enter the information for the group.**

Enter a name for the group and the number of rows and columns.

**4. Click the Next button.**

A third screen is displayed.

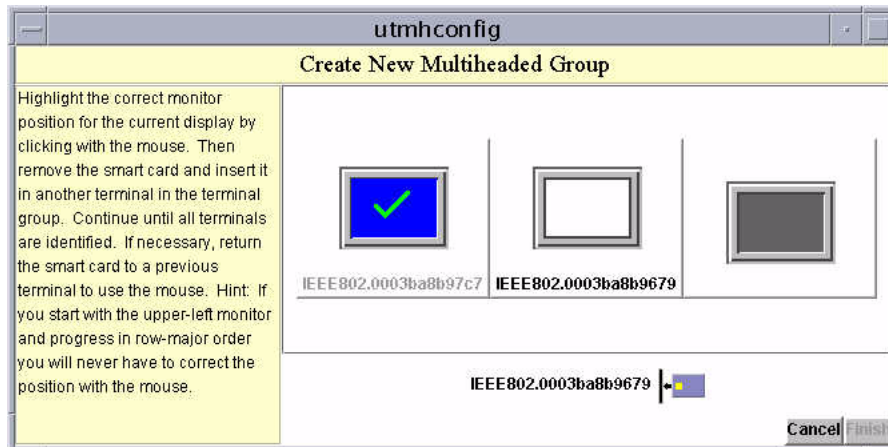

**FIGURE 9-4** Setup Display for the New Multihead Group

**5. Select the DTUs within the multihead group and insert a smart card in each Sun Ray DTU in turn to establish the order of the group.**

The Finish button, which was previously grayed out, is now active.

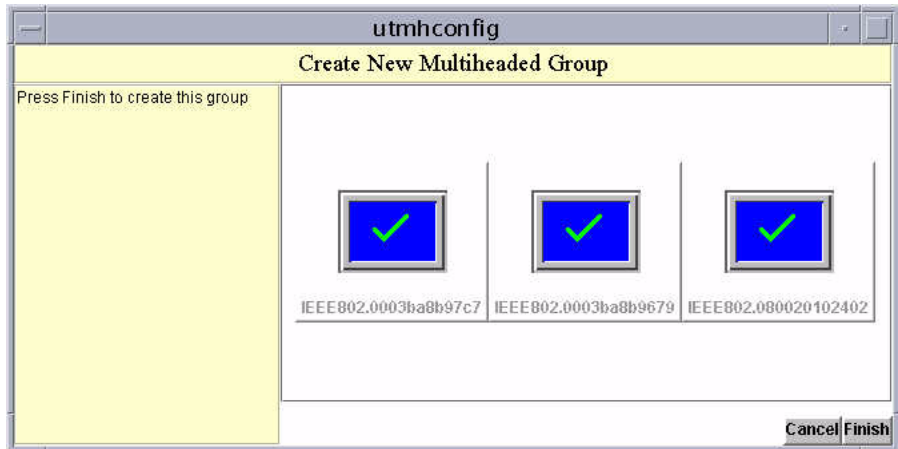

**FIGURE 9-5** Completed Multihead Group List With Active Finish Button

6. Click the Finish button.
7. Exit the session or disconnect by removing your card.

---

## XINERAMA

The XINERAMA extension to X11 creates a single large screen displayed across several monitors. With XINERAMA, only one toolbar is displayed, and a window can be moved smoothly from one part of the screen to the next.

A single CDE toolbar (and set of workspaces) manages the configured monitors. A window can span monitors, since they are still within the same screen. This includes the CDE toolbar itself.

---

**Tip** – XINERAMA tends to consume a lot of CPU, memory, and network bandwidth, so for reasonable performance, set the `shmsys:shminfo_shmmax` parameter in the `/etc/system` file to at least `LARGEST_NUMBER_OF_HEADS * width * height * 4`.

---

Users can enable or disable XINERAMA as part of their X preferences. The `utxconfig` command handles this on an individual token basis; however, the user must log off for this changes to take effect.

The XINERAMA feature is enabled using the following command:

```
% /opt/SUNWut/bin/utxconfig -x on
```

The XINERAMA feature is disabled using the following command:

```
% /opt/SUNWut/bin/utxconfig -x off
```

To enable as default for a single system or failover group, as superuser, type the following command:

```
% utxconfig -a -x on
```

---

**Note** – XINERAMA is not supported on Solaris Trusted Extensions.

---

---

## Session Groups

If you hotdesk from a multihead group to a DTU that is not part of a multihead group—that is, a DTU with a single head—you can view all the screens created in the original multihead group on the single screen, or head by panning to each screen in turn. This is called *screen flipping*.

---

## Authentication Manager

The TerminalGroup policy module extends the Authentication Manager to support multihead groups. When a DTU connects to the Authentication Manager or a new smart card is inserted, the TerminalGroup module queries its database to determine whether the DTU is part of a multihead group and, if so, whether the DTU is a primary or secondary DTU of that group. If it is not identified as part of a multihead group, the DTU is treated normally.

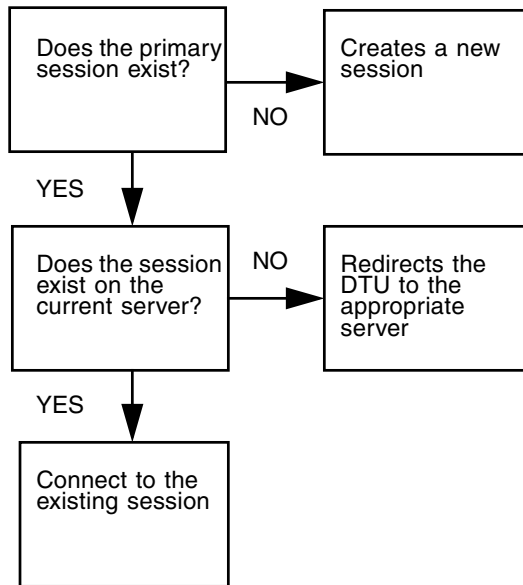

**FIGURE 9-6** Authentication Manager Flowchart for the Primary DTU

If the DTU is determined to be part of a multihead group and it is the multihead group's primary DTU, a normal session placement occurs. If a session does not exist on the current server, but there is a preexisting session for the DTU or smart card on another server in the failover group, the primary DTU will be redirected to that server. If there is no session on any server, the request for a session is directed to the least-loaded server and a session is created there.

If a DTU is determined to be part of a multihead group, and it is a multihead group secondary DTU, the TerminalGroup module determines whether the multihead group primary DTU is locally attached to a session. If so, it tells the Session Manager to allow the secondary DTU to attach to that session also. If the primary DTU is not attached locally, the TerminalGroup module determines whether the primary DTU is attached to another server in the failover group (if any), and if it is, it redirects the secondary DTU to that server.

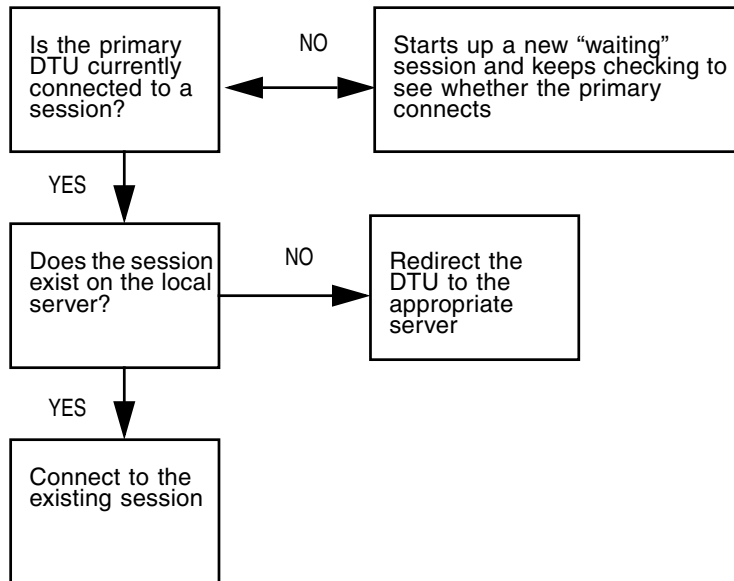

**FIGURE 9-7** Authentication Manager Flowchart for the Secondary DTU

If the primary DTU is determined to not be attached to any server in the failover group at that moment, a Waiting for Primary icon is displayed on the DTU, and further activity is blocked on that DTU until the primary is discovered. The secondary DTU is redirected to the server to which the primary is attached.



## Kiosk Mode

---

This chapter describes Kiosk Mode, including instructions for deployment, installation, and configuration of your system to allow controlled, simplified access to anonymous users without compromising the security of the Sun Ray server. Kiosk Mode was formerly known as Controlled Access Mode (CAM).

Topics include:

- [“Kiosk Mode Functionality” on page 151](#)
- [“Kiosk Mode and Security” on page 159](#)
- [“Preserving Controlled Access Mode \(CAM\) Prototype Data” on page 160](#)
- [“Migrating from Controlled Access Mode \(CAM\) to Kiosk Mode” on page 160](#)
- [“Kiosk Mode Session Using Sun Ray Connector for Windows OS” on page 161](#)

---

## Kiosk Mode Functionality

The Sun Ray thin client infrastructure is well-suited to host Kiosk Mode applications, such as public terminals in airports, in which users access only specified applications and do not need to pass security to log in or to use smart cards. For a detailed explanation of Kiosk Mode, see `kiosk(5)`.



---

**Caution** – Sun Ray Server Software and NIS (Network Information System) store user names and groups in the same system file (`/etc/passwd`). Be sure to use unique user names when setting up a Kiosk Mode application if the same physical server is used to host both the Sun Ray Server Software and the NIS software. If both systems use the same user names, then the `utconfig -u` command can overwrite the NIS entries.

---

# Enabling Kiosk Mode

Kiosk Mode allows the administrator to specify what types of sessions are available to users, based on policy choices for different types of user and usage scenario. For instance, settings can differ for smart card users as opposed to non-smart card users, for those with registered as opposed to unregistered tokens, and for other characteristics.

Kiosk Mode functionality can be enabled and disabled from the System Policy section of the Advanced tab, and administered from the Kiosk Mode section, which provides check boxes to enable Kiosk Mode for smart card users, non-smart card users, or both.

---

**Note** – Before enabling Kiosk Mode you must configure it using `utconfig`.

---

## Enabling Kiosk Mode Using the CLI

As superuser, type the `utpolicy` command for your authentication policy with the addition of the `-k` argument. Some examples are suggested below.

---

**Note** – The following options determine access to the Sun Ray server:

`-z both/pseudo/card`

or

`-r both/pseudo/card [-s both/pseudo/card]`

The `-k both/pseudo/card` option determines whether some or all of the granted sessions are Kiosk sessions.

---

### *To Enable Kiosk Mode for All Users (Card and Non-card)*

```
# /opt/SUNWut/sbin/utpolicy -a -M -s both -r both -k both
```

All users are directed to Kiosk sessions.

### *To Enable Kiosk Mode for Card Users Only*

```
# /opt/SUNWut/sbin/utpolicy -a -M -s both -r both -k card
```

Only card users are directed to Kiosk sessions.

### *To Enable Kiosk Mode for Non-card Users Only*

```
# /opt/SUNWut/sbin/utpolicy -a -M -s both -r both -k pseudo
```

Only non-card users are directed to Kiosk sessions.

### *To Enable Both Card and Non-Card Sessions*

```
# /opt/SUNWut/sbin/utpolicy -z both -k pseudo
```

Card sessions are non-Kiosk (ordinary login) sessions. Non-card sessions are Kiosk sessions.

### *To Allow Only Card Sessions in Kiosk Mode*

```
# /opt/SUNWut/sbin/utpolicy -z card -k card
```

All sessions are in Kiosk Mode and available only to card users, unless you specify overrides.

### *To Enable Regular Sessions for Registered Cards and Kiosk Sessions for Non-Card Users*

```
# /opt/SUNWut/sbin/utpolicy -r card -z pseudo -k pseudo
```

Non-card sessions are Kiosk sessions. Allow non-Kiosk card sessions only for registered tokens.

### *To Enable Kiosk Sessions for Registered Cards and Regular Sessions on Registered DTUS*

```
# /opt/SUNWut/sbin/utpolicy -r both -s both -k card
```

Card sessions are Kiosk sessions, non-card sessions are non-Kiosk (ordinary login) sessions. Users can self-register card tokens and DTUs.

# Enabling Kiosk Mode with the Admin GUI

1. Start the Administration Tool.
2. Select the Advanced tab.
3. Select the System Policy tab (see [FIGURE 10-1](#)).

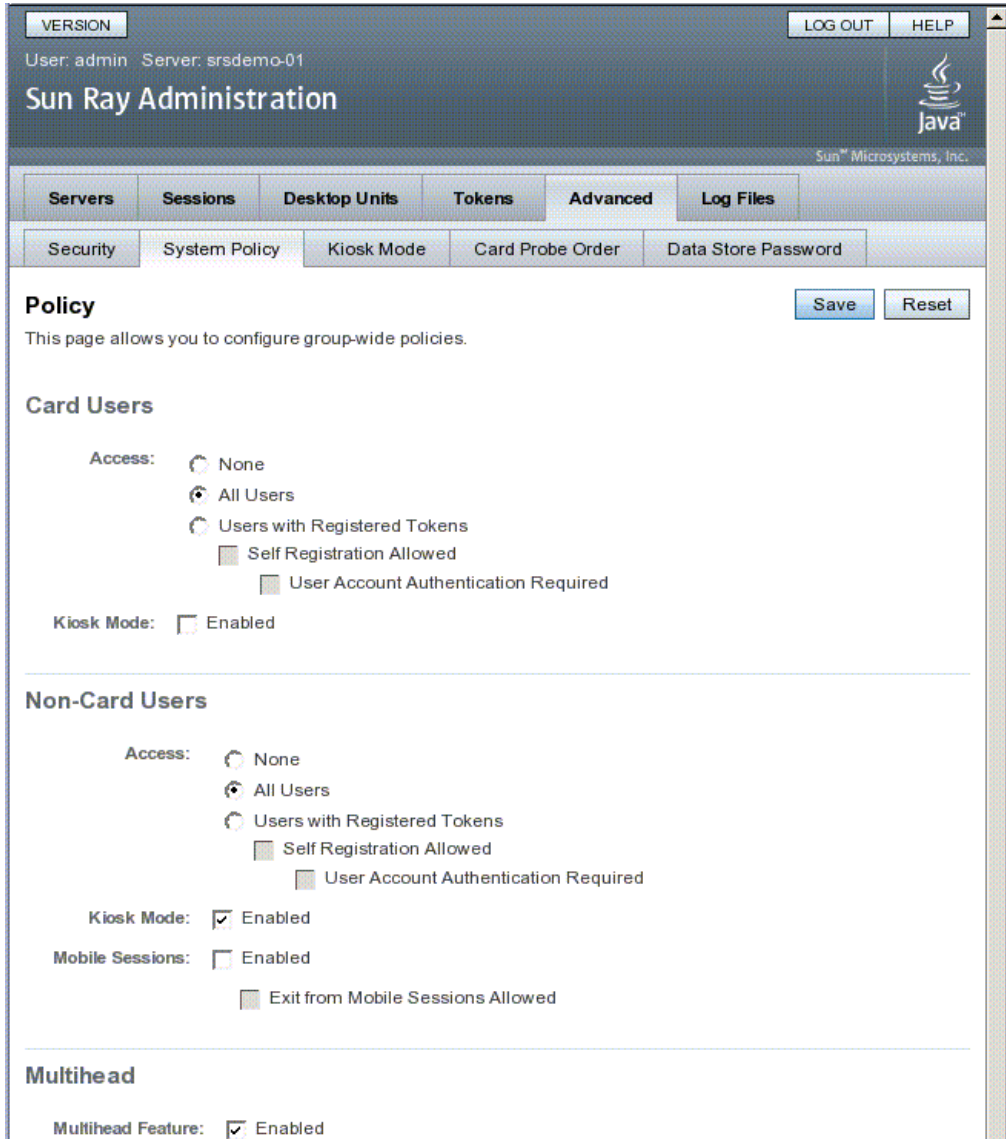

**FIGURE 10-1** Kiosk Mode Enabled for Non-Card Users

4. Select the Kiosk Mode checkbox in the Card Users section, the Non-Card Users section, or both, depending on whether you wish to enable Kiosk Mode for card users, non-card users, or both.
5. Click the Save button.
6. Select the Servers tab
7. Select the relevant server(s) from the list of servers.
8. Click the Cold Restart button.

## Overriding Kiosk Mode Policy

To override Kiosk Mode policy for a given token, use the `utkioskoverride` command.

---

**Note** – If your policy specifies access for All Users, as in [FIGURE 10-1](#), there is no need to override Kiosk Mode policy.

---

For example, to enable Kiosk sessions regardless of Kiosk Mode policy for the registered smart card `MicroPayFlex.12345678`:

```
# /opt/SUNWut/sbin/utkioskoverride -s kiosk -r /  
MicroPayFlex.12345678
```

To disable Kiosk sessions regardless of Kiosk Mode policy for the logical token `user.12345678`:

```
# /opt/SUNWut/sbin/utkioskoverride -s regular -t user.12345678
```

For detailed information on overriding Kiosk Mode policy, see the `utkioskoverride(1m)` man page.

---

**Note** – Only registered tokens—those that have already been registered—can be assigned policy overrides.

---

### ▼ To Override Kiosk Mode Policy from the GUI

1. Select the Tokens tab.
2. Select the token of interest from the list of tokens.

3. Click the Edit button.

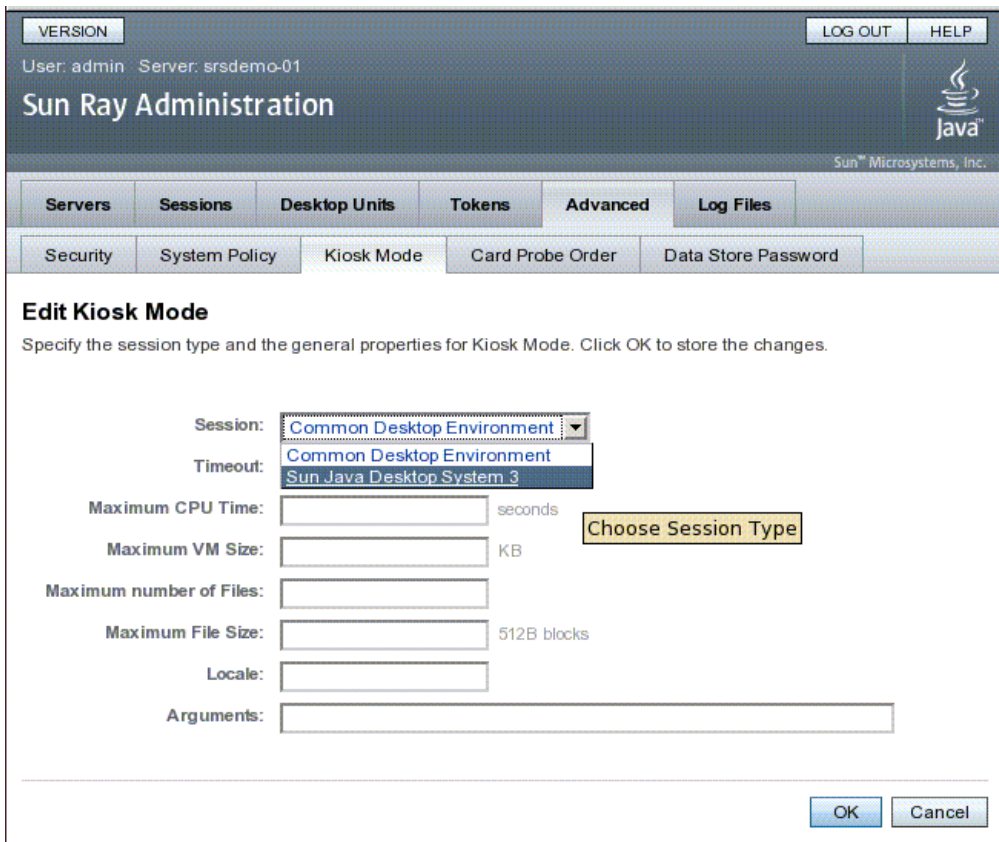

FIGURE 10-2 Edit Kiosk Mode Tab

4. Select the desired Session Type from the list of available session types.

The available session types are Default, Kiosk, and Regular.

a. Select Default to prevent Kiosk Mode policy from being overridden for this token.

or

b. Select Kiosk to use a Kiosk session for this token regardless of Kiosk Mode policy.

or

c. Select Regular to ensure that a Kiosk session is not used for this token, regardless of Kiosk Mode policy.

5. Click the OK button.

## Building the Kiosk Mode Environment

Once you have selected a Kiosk session, that session is launched by default to provide basic Kiosk Mode functionality. Some Kiosk sessions will support the addition of applications to extend this basic functionality.

### ▼ To Configure Kiosk Mode Settings

1. Select the Advanced tab.
2. Select the Kiosk Mode tab.
3. Click the Edit button.
4. Select your preferred Kiosk Session from the Session drop-down list.
5. Provide appropriate values for the remaining settings. See [TABLE 10-1](#) for descriptions of individual settings.
6. Click the OK button.

Changes to Kiosk Mode Settings are applied automatically to Kiosk sessions that start after the changes have been saved. Thus, there is no need to restart Sun Ray services for changes to take effect.

**TABLE 10-1** Kiosk Mode Settings

Setting	Description
Timeout	Indicates the number of seconds after which a disconnected session will be terminated. If you provide no value for this setting, termination of disconnected sessions will be disabled.
Maximum CPU Time	Indicates the maximum number of CPU seconds per process for Kiosk sessions. By default, the system default is applied to all Kiosk sessions. For more information see <code>ulimit(1)</code> .
Maximum VM Size	Indicates the maximum Virtual Memory size per process for Kiosk sessions. By default, the system default is applied to all Kiosk sessions. For more information see <code>ulimit(1)</code> .
Maximum Number of Files	Indicates the maximum number of open files per process for Kiosk sessions. By default, the system default is applied to all Kiosk sessions. For more information see <code>ulimit(1)</code> .

**TABLE 10-1** Kiosk Mode Settings (*Continued*)

Setting	Description
Maximum File Size	Indicates the maximum file size per process for Kiosk sessions. By default, the system default is applied to all Kiosk sessions. For more information see <code>ulimit(1)</code> .
Locale	Indicates the locale to be used by the Kiosk session. By default, the system default is applied to all Kiosk sessions.
Arguments	Indicates a list of arguments that should be passed to Kiosk sessions as they start. This is a Kiosk session-specific setting. For more information on supported arguments, consult the session-specific documentation for your selected session.



**Caution** – Choosing unsuitable values for `ulimit(1)` settings may cause Kiosk sessions to start incorrectly or to crash due to lack of resources.

## ▼ To Add an Application

### 1. Select the **Advanced** tab.

### 2. Select the **Kiosk Mode** tab.

If the currently selected Kiosk session supports the addition of applications, there is an Applications setting at the bottom of the page.

### 3. Click the **New** button.

#### a. To use one of the predefined Kiosk application descriptors:

##### i. Select **Predefined Descriptor**.

##### ii. Choose the relevant descriptor from the drop-down menu.

#### b. To define a custom Kiosk application descriptor:

##### i. Select **Custom Path** to use your own custom Kiosk application descriptor or a system application.

##### ii. Enter the path to your custom Kiosk application descriptor or executable.

If you choose Custom Path, indicate whether the path refers to a custom Kiosk application descriptor or an executable by choosing either Descriptor or Executable.

### 4. Select your preferred **Start Mode** for the application.

#### a. Choose **USER** to allow users to start the application themselves, for instance from a menu or launcher item.

#### b. Choose **AUTO** to make the application start automatically when the Kiosk session starts.



- c. Choose **CRITICAL** to make the application start automatically when the Kiosk session starts, to allow users to start the application themselves, and to force the Kiosk session to restart if the application terminates.
5. Enter any application specific arguments.

---

**Note** – Individual Kiosk sessions may handle the various application start modes and arguments differently. For precise details on these, consult the session-specific documentation of your selected Kiosk session.

---

---

## Kiosk Mode and Security

Since Kiosk Mode bypasses the system login mechanism, you must consider the security of the applications added to the user environment. Many custom applications provide built-in security; other applications do not and are therefore not suitable for Kiosk Mode.

For example, adding an application such as `xterm` provides users with access to a command-line interface from a Kiosk Mode session. This would not be desirable in a public environment and is not advised. However, using a custom application for a call center would be perfectly acceptable.

## Failover

In a failover environment, the Kiosk Mode administrative settings are copied to the failover servers. Be sure that all application descriptor and executable paths added to the Kiosk Mode sessions are copied across the servers in the failover group (FOG). For example, if the Mozilla application is added to the sessions with the executable path `/usr/sfw/bin/mozilla`, make sure that the path to the binary is available to all servers in the failover group. One way of ensuring that sessions and applications are available on all servers in a FOG is to put them into a shared network directory, which is available on all hosts in the FOG.

---

## Preserving Controlled Access Mode (CAM) Prototype Data

To continue using an existing CAM configuration after upgrading to the latest Sun Ray Server Software, CAM configuration data must be migrated so that it can be used by the new Sun Ray Kiosk Mode. Successful migration requires you to preserve available CAM prototype data manually before upgrading. The data is then restored once the upgrade is complete.

### ▼ To Preserve CAM Prototype Data

- To preserve CAM prototype data, execute the following commands:

```
# cd /var/opt/SUNWut/kiosk
# tar cf /var/tmp/prototypes.tar prototypes
```

---

**Tip** – Copy the file `/var/tmp/prototypes.tar` to a safe location, such as on another host, before any upgrade.

---

### ▼ To Restore CAM Prototype Data

- To restore CAM prototype data, execute the following commands:

```
# cd /var/opt/SUNWut/kiosk
# tar xf /var/tmp/prototypes.tar
```

---

## Migrating from Controlled Access Mode (CAM) to Kiosk Mode

As of the Sun Ray Server Software 4.0 release, CAM has been replaced by Kiosk Mode. To continue using previous CAM configuration with Kiosk Mode, you must migrate all relevant CAM configuration data to its Kiosk Mode equivalent. The `utccammigrate(1m)` tool creates all the required Kiosk Mode applications and prototypes needed to convert an old CAM configuration to Kiosk Mode.

## ▼ To Migrate from CAM to Kiosk Mode

- To complete the migration process, simply execute the following command.

```
# /opt/SUNWut/sbin/utcammigrate -u
```

where the `-u` option instructs `utcammigrate` to upload the relevant Kiosk Mode session configuration and selected applications list to the Sun Ray Data Store. This effectively selects the migrated session for use with all subsequent client connections. If you do not wish to select the session for immediate use, you may omit the `-u` option from the command above and configure your session manually using the Sun Ray Admin GUI.

## Failover Group Migration

Specifying the `-u` option results in the automatic selection of the migrated session. This selection applies to all hosts in a failover group and, as such, it is essential that the migration be completed first before the selection takes place. To ensure that this is the case, you should execute `/opt/SUNWut/sbin/utcammigrate` without any options on all hosts but one in a failover group. You may then safely execute `/opt/SUNWut/sbin/utcammigrate -u` on the last host in the group.

For a more detailed explanation of the migration process, see the `utcammigrate(1m)` man page.

---

# Kiosk Mode Session Using Sun Ray Connector for Windows OS

This product provides support for Sun Ray Connector sessions in Kiosk Mode. The core components of this product are a Kiosk Session Service session descriptor (`/etc/opt/SUNWkio/sessions/uttsc.conf`) and a Kiosk Session Service session script (`/etc/opt/SUNWkio/sessions/uttsc/uttsc`). This session does not support added applications.

# Session Descriptor

The session descriptor defines a number of attributes useful for the administration and launching of the session. These include

**TABLE 10-2** Kiosk Session Descriptors

Descriptor	Description
KIOSK_SESSION_EXEC	Identifies the location of the session script.
KIOSK_SESSION_LABEL KIOSK_SESSION_DESCRIPTION	Identify a label and description respectively to be used by the Sun Ray Admin GUI.
KIOSK_SESSION_ARGS	Identifies default session script arguments.

For more details, see [“Session Script Arguments” on page 162](#).

## Session Script

The session script is responsible for launching the Sun Ray Connector. The script provides a simple wrapper on the Sun Ray Connector executable, `/opt/SUNWuttsc/bin/uttsc`.

A two-minute timeout is imposed on Windows sessions that remain at the Windows login screen. When this timeout elapses, the associated Windows session is terminated, and the Sun Ray Connector terminates subsequently. This can result in a user experience where, assuming no Windows login takes place, a desktop unit appears to reset every two minutes. To avoid this, the session script supports its own timeout, which affects its behavior when it detects that the Sun Ray Connector has terminated. If the timeout interval has not elapsed, the session script relaunches the Sun Ray Connector. If the timeout has elapsed, the session script terminates, and the Kiosk session also terminate as a result. The timeout may be specified as a session script argument. It has a default value of 30 minutes.

## Session Script Arguments

A number of arguments are supported by the session script. These may be specified using the Sun Ray Admin GUI. The list of supported arguments may be split into Sun Ray Connector and non-Sun Ray Connector arguments. Sun Ray Connector arguments are not processed in any way by the session script and are simply passed directly to the Sun Ray Connector. Non-Sun Ray Connector arguments are processed by the session script itself.

The complete argument list should be formatted according to the following example:

```
[<Non Sun Ray Connector arguments>] [ "--" <Sun Ray Connector arguments>]
```

## Non-Sun Ray Connector Arguments

Currently, only a single non-Sun Ray argument, `-t`, is supported. It is defined as follows:

`-t <timeout>` sets the value of a timeout interval (in seconds) after which the session script will terminate in the event of a Sun Ray Connector termination. If Sun Ray Connector terminates before the timeout has elapsed it will be restarted by the session script. The default value for `<timeout>` is 1800 (30 minutes). Values less than or equal to 0 indicate that the session script should never restart the Sun Ray Connector.

## Sun Ray Connector Arguments

You may specify any valid `uttsc(1)` arguments here. The `-m` and `-b uttsc(1)` arguments are used by default. These arguments enable full-screen mode and disable the pull-down header respectively.

---

**Note** – The Sun Ray Connector requires at least a *server* argument. As previously mentioned, you may use the Sun Ray Admin GUI to include this server argument in the session script argument list.

---

## Supplemental Information

Two features linked to Sun Ray Connector are commonly implemented at customer sites: Follow-Me-Printing and Windows Session Locking. Implementations of these features rely on technology not available by default and non-public Sun Ray interfaces as well as the use of certain public Sun Ray interfaces for purposes other their intended use. For these reasons, these features are not provided as supported elements of this session; however, descriptions of how these features are commonly implemented are provided in the following sections.

## Follow-Me-Printing

This feature is used to allow the default printer for a given Windows session to appear to move with a user from one Sun Ray DTU to another. Use the following steps to provide this feature.

1. **For each Sun Ray of interest, specify an associated printer in the Sun Ray Data Store.**

This may be done by navigating to the relevant Desktop Unit in the Sun Ray Admin GUI and setting its Other Information field to the name of the relevant printer.

2. **Provide a shell script which queries the printer name stored in the Sun Ray Data Store for the current Sun Ray DTU and writes that name to the user's \$HOME/.printers file.**

For example:

```
#!/bin/sh
if [ `uname` = Linux ] ; then
  theFlag="-P"
fi
theMACAddress=`cd $theFlag $UTDEVROOT ; pwd | sed
's/.*<.....>\/\1/'`
thePrinter=`/opt/SUNWut/sbin/utdesktop -o |
            grep $theMACAddress          |
            /usr/bin/awk -F, '{print $3}'`
echo "_default $thePrinter" > $HOME/.printers
```

3. **Use utaction(1) to invoke the script above on an initial connection and subsequently whenever a user moves from one Sun Ray DTU to another.**

This can be done by providing an Xsession.d script if you are using dtlogin as your login manager or an xinitrc.d script if you are using Gnome Display Manager (GDM) as your login manager. For example, you might create the script /usr/dt/config/Xsession.d/1100.SUNWut for dtlogin or /etc/X11/xinit/xinitrc.d/1100.SUNWut for GDM as follows:

```
#!/bin/sh
/opt/SUNWut/bin/utaction -i -c <path-to-script> &
```

where <path-to-script> is the path to the script you created to retrieve the printer name.

---

**Note** – The name `1100.SUNWut` is chosen purposely in this case to ensure that the script is run or sourced after the existing script `0100.SUNWut`. This is required as `0100.SUNWut` is responsible for setting `$UTDEVROOT` which is needed by the first sample script above.

---

#### 4. Modify your Kiosk session script arguments to redirect the printer to Windows.

You may modify these arguments using the Sun Ray Admin GUI. In this example you need to add the argument `-r printer:_default` to the existing arguments, resulting in an argument list similar to the following:

```
-t 1800 -- -m -b -r printer:_default myHost
```

where *myHost* corresponds to the server argument passed to `uttsc(1)`.

## Windows Session Locking

It may be preferable that a Windows session be locked when a user's session moves away from a given Sun Ray DTU. A commonly used approach to implement this is to send the lockscreen keystrokes to the Windows Session using `xvkbd` (invoked by `utaction`).

As with the previous example, you may invoke `utaction` from an `Xsession.d` or `xinitrc.d` script as follows:

```
#!/bin/sh
XVKBD=/usr/openwin/bin/xvkdb
/opt/SUNWut/bin/utaction -d "$XVKBD -text '\Ml' " &
```

---

**Note** – `xvkbd` is not available by default, so you should modify the `XVKBD` setting above so that it correctly identifies the installation location of `xvkbd` in your case.

---

---

**Note** – The keystroke sequence `\Ml` activates the Windows lock for Windows 2003/XP sessions. You may need to modify it for other Windows versions.

---





# Failover Groups

---

Sun Ray servers configured in a *failover group* provide users with a high level of availability when one of those servers becomes unavailable because of a network or system failure. This chapter describes how to configure failover groups.

For a discussion on how to utilize multiple failover groups to utilize *regional hotdesking*, see “Hotdesking (Mobile Sessions)” on page 67.

This chapter covers these topics:

- “Failover Group Overview” on page 168
- “Setting Up IP Addressing” on page 170
- “Group Manager” on page 176
- “Load Balancing” on page 178
- “Setting Up a Failover Group” on page 179
- “Viewing the Administration Status” on page 181
- “Viewing Network (Failover Group) Status” on page 181
- “Recovery Issues and Procedures” on page 183
- “Setting Up a Group Signature” on page 185
- “Taking Servers Offline” on page 186

# Failover Group Overview

A failover group consists of two or more Sun Ray servers grouped together to provide highly-available and scalable Sun Ray service for a population of Sun Ray DTUs. Releases earlier than 2.0 supported DTUs available to the servers only on a common, dedicated interconnect. Beginning with the 2.0 release, this capability was expanded to allow access across the LAN to either local or remote Sun Ray devices. However, the servers in a failover group must still be able to reach one another, using multicast or broadcast, over at least one shared subnet. Servers in a group authenticate (or “trust”) one another using a common group signature. The group signature is a key used to sign messages sent between servers in the group; it must be configured to be identical on each server.

Failover groups that use more than one version of Sun Ray Server Software will be unable to use all the features provided in the latest releases. On the other hand, the failover group can be a heterogeneous group of Sun servers running various releases of the Solaris operating environment, such as Solaris 9, and Solaris 10.

When a dedicated interconnect is used, all servers in the failover group should have access to, and be accessible by, all the Sun Ray DTUs on a given sub-net. The failover environment supports the same interconnect topologies that are supported by a single-server Sun Ray environment; however, switches should be multicast-enabled.

[FIGURE 11-1](#) illustrates a typical Sun Ray failover group. For an example of a redundant failover group, see [FIGURE 11-2](#).

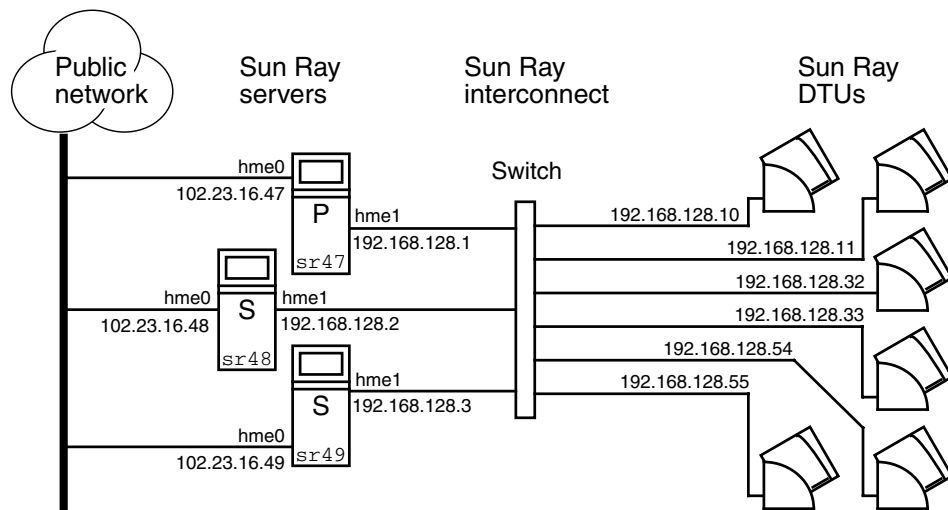

**FIGURE 11-1** Simple Failover Group

When a server in a failover group fails for any reason, each Sun Ray DTU connected to that server reconnects to another server in the same failover group. The failover occurs at the user authentication level: the DTU connects to a previously existing session for the user's token. If there is no existing session, the DTU connects to a server selected by the load-balancing algorithm. This server then presents a login screen to the user, and the user must relogin to create a new session. The state of the session on the failed server is lost.

The principal components needed to implement failover are:

- Group Manager
  - A module that monitors the availability (liveness) of the Sun Ray servers and facilitates redirection when needed.
- Multiple, coexisting Dynamic Host Configuration Protocol (DHCP) servers
  - All DHCP servers configured to assign IP addresses to Sun Ray DTUs have a non-overlapping subset of the available address pool.

---

**Note** – The failover feature cannot work properly if the IP addresses and DHCP configuration data are not set up properly when the interfaces are configured. In particular, if any Sun Ray server's interconnect IP address is a duplicate of any other server's interconnect IP address, the Sun Ray Authentication Manager throws "Out of Memory" errors.

---

The redundant failover group illustrated in [FIGURE 11-2](#) can provide maximum resources to a few Sun Ray DTUs. The server `sr47` is the primary Sun Ray server, and `sr48` is the secondary Sun Ray server; other secondary servers (`sr49`, `sr50` . . . are not shown.

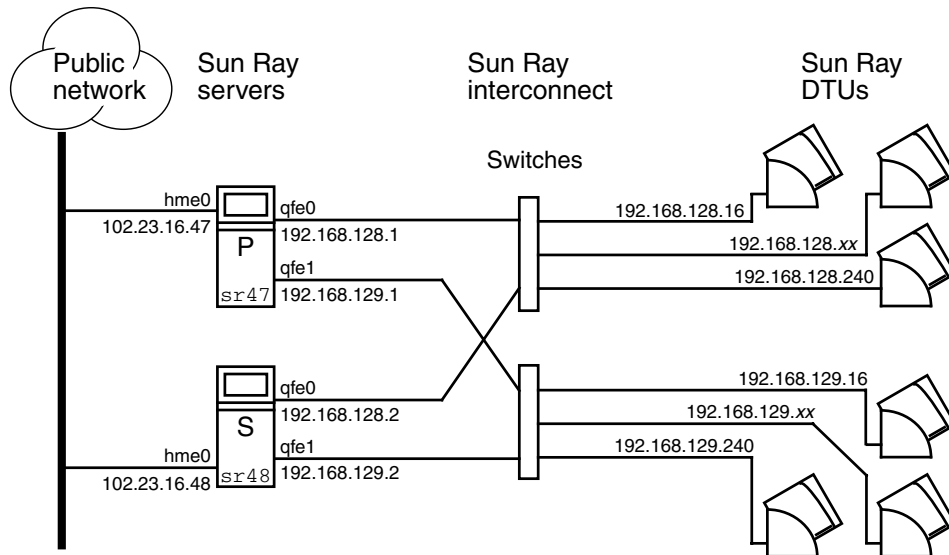

FIGURE 11-2 Redundant Failover Group

## Setting Up IP Addressing

The `utadm` command assists you in setting up a DHCP server. The default DHCP setup configures each interface for 225 hosts and uses private network addresses for the Sun Ray interconnect. For more information on using the `utadm` command, see the man page for `utadm`.

Before setting up IP addressing, you must decide upon an addressing scheme. The following examples discuss setting up class C and class B addresses.

## Setting Up Server and Client Addresses

The loss of a server usually implies the loss of its DHCP service and its allocation of IP addresses. Therefore, more DHCP addresses must be available from the address pool than there are Sun Ray DTUs. Consider the situation of five servers and 100 DTUs. If one of the servers fails, the remaining DHCP servers must have enough available addresses so that every “orphaned” DTUs gets a new working address.

[TABLE 11-1](#) describes how to configure five servers for 100 DTUs, accommodating the failure of two servers (class C) or four servers (class B).

**TABLE 11-1** Configuring Five Servers for 100 DTUs

Servers	Class C (2 Servers Fail)		Class B (4 Servers Fail)	
	Interface Address	DTU Address Range	Interface Address	DTU Address Range
serverA	192.168.128.1	192.168.128.16 to 192.168.128.49	192.168.128.1	192.168.128.16 to 192.168.128.116
serverB	192.168.128.2	192.168.128.50 to 192.168.128.83	192.168.129.1	192.168.129.16 to 192.168.129.116
serverC	192.168.128.3	192.168.128.84 to 192.168.128.117	192.168.130.1	192.168.130.16 to 192.168.130.116
serverD	192.168.128.4	192.168.128.118 to 192.168.128.151	192.168.131.1	192.168.131.16 to 192.168.131.116
serverE	192.168.128.5	192.168.128.152 to 192.168.128.185	192.168.132.1	192.168.132.16 to 192.168.132.116

The formula for address allocation is: address range (AR) = number of DTUs/(total servers - failed servers). For example, in the case of the loss of two servers, each DHCP server must be given a range of  $100/(5-2) = 34$  addresses.

Ideally, each server would have an address for each DTU. This would require a class B network. Consider these conditions:

- If AR multiplied by the total number of servers is *less than or equal to 225*, configure for a class C network
- If AR multiplied by the total number of servers is *greater than 225*, configure for a class B network

---

**Tip** – If all available DHCP addresses are allocated, it is possible for a Sun Ray DTU to request an address yet not find one available, perhaps because another unit has been allocated IP addresses by multiple servers. To prevent this condition, give each DHCP server enough addresses to serve the all the DTUs in a failover group.

---

## Server Addresses

Server IP addresses assigned for the Sun Ray interconnect should all be unique. Use the `utadm` tool to assign them.

When the Sun Ray DTU boots, it sends a DHCP broadcast request to all possible servers on the network interface. One (or more) server responds with an IP address allocated from its range of addresses. The DTU accepts the first IP address that it receives and configures itself to send and receive at that address.

The accepted DHCP response also contains information about the IP address and port numbers of the Authentication Managers on the server that sent the response.

The DTU then tries to establish a TCP connection to an Authentication Manager on that server. If it is unable to connect, it uses a protocol similar to DHCP, in which it uses a broadcast message to ask the Authentication Managers to identify themselves. The DTU then tries to connect to the Authentication Managers that respond in the order in which the responses are received.

---

**Note** – For the broadcast feature to be enabled, the broadcast address (255.255.255.255) must be the last one in the list. Any addresses after the broadcast address are ignored. If the local server is not on the list, Sun Ray DTUs cannot attempt to contact it.

---

Once a TCP connection to an Authentication Manager has been established, the DTU presents its token. The token is either a pseudo-token representing the individual DTU (its unique Ethernet address) or a smart card. The Session Manager then starts an X window/X server session and binds the token to that session.

The Authentication Manager then sends a query to all the other Authentication Managers on the same subnet and asks for information about existing sessions for the token. The other Authentication Managers respond, indicating whether there is a session for the token and the last time the token was connected to the session.

The requesting Authentication Manager selects the server with the latest connection time and redirects the DTU to that server. If no session is found for the token, the requesting Authentication Manager selects the server with the lightest load and redirects the token to that server. A new session is created for the token.

The Authentication Manager enables both implicit (smart card) and explicit switching. For explicit switching, see [“Group Manager” on page 176](#).

## Configuring DHCP

In a large IP network, a DHCP server distributes the IP addresses and other configuration information for interfaces on that network.

## Coexistence of the Sun Ray Server With Other DHCP Servers

The Sun Ray DHCP server can coexist with DHCP servers on other subnets, provided you isolate the Sun Ray DHCP server from other DHCP traffic. Verify that all routers on the network are configured not to relay DHCP requests. This is the default behavior for most routers.

---

**Caution** – If the IP addresses and DHCP configuration data are not set up correctly when the interfaces are configured, the failover feature cannot work properly. In particular, configuring the Sun Ray server’s interconnect IP address as a duplicate of any other server’s interconnect IP address may cause the Sun Ray Authentication Manager to throw “Out of Memory” errors.

---

## Administering Other Clients

If the Sun Ray server has multiple interfaces, one of which is the Sun Ray interconnect, the Sun Ray DHCP server should be able to manage both the Sun Ray interconnect and the other interfaces without cross-interference.

### ▼ To Set Up IP Addressing on Multiple Servers Each With One Sun Ray Interface

1. Log in to the Sun Ray server as superuser and, open a shell window. Type:

```
# /opt/SUNWut/sbin/utadm -a <interface_name>
```

where *<interface\_name>* is the name of the Sun Ray network interface to be configured; for example, *hme[0-9]*, *qfe[0-9]*, or *ge[0-9]*. You must be logged on as superuser to run this command. The *utadm* script configures the interface (for example, *hme1*) at the subnet (in this example, 128).

The script displays default values, such as the following:

```
Selected values for interface "hme1"
  host address:      192.168.128.1
  net mask:         255.255.255.0
  net address:      192.168.128.0
  host name:        serverB-hme1
  net name:         SunRay-hme1
  first unit address: 192.168.128.16
  last unit address: 192.168.128.240
  auth server list: 192.168.128.1
  firmware server:  192.168.128.1
  router:           192.168.128.1
```

The default values are the same for each server in a failover group. Certain values must be changed to be unique to each server.

**2. When you are asked to accept the default values, type n:**

```
Accept as is? ([Y]/N): n
```

**3. Change the second server's IP address to a unique value, in this case 192.168.128.2:**

```
new host address: [192.168.128.1] 192.168.128.2
```

**4. Accept the default values for netmask, host name, and net name:**

```
new netmask: [255.255.255.0]
new host name: [serverB-hme1]
```

**5. Change the DTU address ranges for the interconnect to unique values. For example:**

```
Do you want to offer IP addresses for this interface? [Y/N]:
new first Sun Ray address: [192.168.128.16] 192.168.128.50
number of Sun Ray addresses to allocate: [205] 34
```



**6. Accept the default firmware server and router values:**

```
new firmware server: [192.168.128.2]
new router: [192.168.128.2]
```

The utadm script asks if you want to specify an authentication server list:

```
auth server list:      192.168.128.1
To read auth server list from file, enter file name:
Auth server IP address (enter <CR> to end list):
If no server in the auth server list responds, should an auth
server be located by broadcasting on the network? ([Y]/N):
```

These servers are specified by a file containing a space-delimited list of server IP addresses or by manually entering the server IP addresses.

The newly selected values for interface hme1 are displayed:

```
Selected values for interface "hme1"
  host address:      192.168.128.2
  net mask:         255.255.255.0
  net address:      192.168.128.0
  host name:        serverB-hme1
  net name:         SunRay-hme1
  first unit address: 192.168.128.50
  last unit address: 192.168.128.83
  auth server list: 192.168.128.1
  firmware server:  192.168.128.2
  router:          192.168.128.2
```

**7. If these are correct, accept the new values:**

```
Accept as is? ([Y]/N): y
```

**8. Stop and restart the server and power cycle the DTUs to download the firmware.**

TABLE 11-2 lists the options available for the `utadm` command. For additional information, see the `utadm` man page.

TABLE 11-2 Available Options

Option	Definition
-c	Create a framework for the Sun Ray interconnect.
-r	Remove all Sun Ray interconnects.
-A <subnetwork>	Configure the subnetwork specified as a Sun Ray sub-network. This option only configures the DHCP service to allocate IP address and/or to provide Sun Ray parameters to Sun Ray clients. It also will automatically turn on support for LAN connections from a shared subnetwork.
-a <interface_name>	Add <interface_name> as Sun Ray interconnect.
-D <subnetwork>	Delete the subnetwork specified form the list of configured Sun Ray subnetworks.
-d <interface_name>	Delete <interface_name> as Sun Ray interconnect.
-l	Print the current configuration for all the Sun Ray subnetworks, including remote subnetworks.
-p	Print the current configuration.
-f	Take a server offline
-n	Bring a server online
-x	Print the current configuration in a machine-readable format

---

## Group Manager

Every server has a group manager module that monitors availability and facilitates redirection. It is coupled with the Authentication Manager.

In setting policies, the Authentication Manager uses the selected authentication modules and decides what tokens are valid and which users have access.

---

**Warning** – The same policy must exist on every server in the failover group or undesirable results might occur.

---

The Group Managers create maps of the failover group topology by exchanging keepalive messages among themselves. These keepalive messages are sent to a well-known UDP port (typically 7009) on all of the configured network interfaces.

The `keepalive` message contains enough information for each Sun Ray server to construct a list of servers and the common subnets that each server can access. In addition, the Group Manager remembers the last time that a `keepalive` message was received from each server on each interface.

The `keepalive` message contains the following information about the server:

- Server's host name
- Server's primary IP address
- Elapsed time since it was booted
- IP information for every interface it can reach
- Machine information (number and speed of CPUs, configured RAM, and so on)
- Load information (CPU and memory utilization, number of sessions, and so on)

---

**Note** – The last two items are used to facilitate load distribution. See [“Load Balancing” on page 178](#).

---

The information maintained by the Group Manager is used primarily for server selection when a token is presented. The server and subnet information is used to determine the servers to which a given DTU can connect. These servers are queried about sessions belonging to the token. Servers whose last `keepalive` message is older than the timeout are deleted from the list, since either the network connection or the server is probably down.

## Redirection

In addition to automatic redirection at authentication, you can use the `utselect` or `utswitch` command for manual redirection.

---

**Note** – The `utselect` GUI is the preferred method to use for server selection. For more information, see the `utselect` man page.

---

## Group Manager Configuration

The Authentication Manager configuration file, `/etc/opt/SUNWut/auth.props`, contains properties used by the Group Manager at runtime. The properties are:

- `gmport`
- `gmKeepAliveInterval`
- `enableGroupManager`
- `enableLoadBalancing`
- `enableMulticast`

- multicastTTL
- gmSignatureFile
- gmDebug

---

**Note** – These properties have default values that are rarely changed. Only very knowledgeable Sun support personnel should direct customers to change these values to help tune or debug their systems. If any properties are changed, they must be changed for all servers in the failover group, since the `auth.props` file must be the same on all servers in a failover group.

---

## ▼ To Restart the Authentication Manager

Property changes do not take effect until the Authentication Manager is restarted.

- As superuser, open a shell window and type:

```
# /opt/SUNWut/sbin/utrestart
```

The Authentication Manager is restarted.

---

# Load Balancing

At the time of a server failure, the Group Manager on each remaining server attempts to distribute the failed server's sessions evenly among the remaining servers. The load balancing algorithm takes into account each server's capacity (number and speed of its CPUs) and load so that larger or less heavily loaded servers host more sessions.

When the Group Manager receives a token from a Sun Ray DTU and finds that no server owns an existing session for that token, it redirects the Sun Ray DTU to whichever server in the group has the lightest load. A Sun Ray DTU may appear to connect twice, once on the server that answered its DHCP request and a second time on a server that was less loaded than the first.

## ▼ To Turn Off the Load Balancing Feature

- In the `auth.props` file set:

```
enableLoadBalancing = false
```

---

# Setting Up a Failover Group

A failover group is one in which two or more Sun Ray servers use a common policy and share services. It is composed of a primary server and one or more secondary servers. For such a group, you must configure a Sun Ray Data Store to enable replication of the Sun Ray administration data across the group. Configure the secondary servers so that they serve users directly in addition to serving the Data Store. For best results in groups of four or more servers, configure the primary server so that it serves only the Sun Ray Data Store.

The `utconfig` command sets up the data store for a single system initially, and enables the Sun Ray servers for failover. The `utreplica` command then configures the Sun Ray servers as a failover group.

If the Sun Ray server is currently monitored by Sun Management Center, `utreplica` restarts the agent automatically. Log files for Sun Ray servers contain time-stamped error messages which are difficult to interpret if the time is out of sync. To make troubleshooting easier, all secondary servers should periodically synchronize with their primary server.

---

**Tip** – Use `rdate <primary-host>`, preferably with `crontab`, to synchronize secondary servers with their primary server.

---

## Primary Server

Layered administration of the group takes place on the primary server. The `utreplica` command designates a primary server, advises the server of its Administration Primary status, and tells it the host names of all the secondary servers.

Adding or removing secondary servers requires services to be restarted on the primary server. In large failover groups, and significant loads may be pushed onto the primary server from various sources. In addition, runaway processes from user applications on the primary can degrade the health of the entire failover group. Failover groups of more than four servers should have a dedicated primary server devoted to solely serving the Sun Ray Data Store, i.e., not hosting any Sun Ray sessions.

---

**Tip** – Configure the primary server before you configure the secondary servers.

---

## ▼ To Specify a Primary Server

- As a superuser, open a shell window on the primary server and type:

```
# /opt/SUNWut/sbin/utreplica -p secondary-server1 [secondary-server2 ...]
```

where *secondary\_server1* [*secondary\_server2...*] is a space-separated list of unique host names of the secondary servers.

## ▼ To Specify a Dedicated Primary Server

The purpose of a dedicated primary server is to serve the Sun Ray Data Store.

- Follow the procedure to specify a primary server, as above; however, do not run `utadm` on this server.

## Secondary Server

The secondary servers in the group store a replicated version of the primary server's administration data. Use the `utreplica` command to advise each secondary server of its secondary status and also the host name of the primary server for the group.

## ▼ To Specify Each Secondary Server

- As superuser, open a shell window on the secondary server and type:

```
# /opt/SUNWut/sbin/utreplica -s primary-server
```

where *primary-server* is the hostname of the primary server.

## ▼ To Add Additional Secondary Servers

To include an additional secondary server in an already configured failover group:

1. On the primary server, rerun `utreplica -p -a` with a list of secondary servers.

```
# /opt/SUNWut/sbin/utreplica -p -a secondary-server1, secondary-server2,...
```

2. Run `utreplica -s primary-server` on the new secondary server.

```
# /opt/SUNWut/sbin/utreplica -s primary-server
```

## Removing Replication Configuration

### ▼ To Remove the Replication Configuration

- As superuser, open a shell window and type:

```
# /opt/SUNWut/sbin/utreplica -u
```

This removes the replication configuration.

---

## Viewing the Administration Status

### ▼ To Show Current Administration Configuration

- As superuser, open a shell window and type:

```
# /opt/SUNWut/sbin/utreplica -l
```

The result indicates whether the server is standalone, primary (with the secondary host names), or secondary (with the Primary host name).

---

## Viewing Network (Failover Group) Status

A failover group is a set of Sun Ray servers all running the same release of Sun Ray Server Software and all having access to all the Sun Ray DTUs on the interconnect.

### ▼ To View Failover Group Status

1. From the Servers tab in the Admin GUI, click on a server name to display its Server Details screen.
2. Click View Network Status.

VERSION LOG OUT HELP

User: admin Server: srsdemo-02

# Sun Ray Administration

Sun Microsystems, Inc.

Servers Sessions Desktop Units Tokens Advanced Log Files

[All Servers](#) > [srsdemo-02](#) > Network Status

## srsdemo-02 - Network Status

[Back to srsdemo-02](#)

This page lists the network status of all trusted and non-trusted servers from the perspective of the selected server.

### Network Status (17)

Server Name	10.6.128.0/24			10.6.133.0/24			192.168.128.0/24		
	Address	Status	Type	Address	Status	Type	Address	Status	Type
srsdemo-02				10.6.133.171	Up	LAN	192.168.128.2	Up	Interconnect
<b>Failover Group Servers (Trusted Servers)</b>									
srsdemo-01				10.6.133.148	Up	LAN	192.168.128.1	Up	Interconnect
<b>Other Servers (Untrusted Servers)</b>									
ray-133				10.6.133.133	Up	LAN	192.168.128.2	Down	LAN
ray-144				10.6.133.144	Up	LAN			
ray-205				10.6.133.205	Up	LAN	192.168.128.1	Down	Interconnect
ray-156.SFBay.Sun.COM	10.6.128.155	Down	LAN	10.6.133.156	Up	LAN	192.168.128.6	Down	Interconnect
ray-134				10.6.133.134	Up	LAN	192.168.128.1	Down	Interconnect
ray-146.SFBay.Sun.COM				10.6.133.146	Up	LAN			
ray-149.sfbay.sun.com				10.6.133.149	Up	LAN	192.168.128.1	Down	LAN
ray-128				10.6.133.128	Up	LAN	192.168.128.2	Down	Interconnect
ray-155				10.6.133.155	Up	LAN			
ray-127				10.6.133.127	Up	LAN	192.168.128.1	Down	Interconnect
ray-142				10.6.133.142	Up	LAN	192.168.128.1	Down	Interconnect
ray-203.sfbay.sun.com				10.6.133.203	Up	LAN	192.168.128.1	Down	Interconnect
ray-163.SFBay.Sun.COM				10.6.133.163	Down	LAN			
ray-154				10.6.133.154	Up	LAN	192.168.128.4	Down	Interconnect

[Back to srsdemo-02](#)

**FIGURE 11-3** Network Status Screen

The Network Status screen provides information on group membership and network connectivity for servers in the same failover group and for any other Sun Ray servers that have responded to a Sun Ray broadcast. The servers are listed by name in the first column. Failover Group Status only displays public networks and Sun Ray interconnect fabrics.



---

**Note** – Sun Ray server broadcasts do not traverse routers or servers other than Sun Ray servers.

---

## Recovery Issues and Procedures

If one of the servers of a failover group fails, the remaining group members operate from the administration data that existed prior to the failure.

The recovery procedure depends on the severity of the failure and whether a primary or secondary server has failed.

---

**Note** – When the primary server fails, you cannot make administrative changes to the system. For replication to work, all changes must be successful on the primary server.

---

### Primary Server Recovery

There are several strategies for recovering the primary server. The following procedure is performed on the same server which was the primary after making it fully operational.

#### ▼ To Rebuild the Primary Server Administration Data Store

Use this procedure to rebuild the primary server data store from a secondary server. This procedure uses the same hostname for the replacement server.

1. **On one of the secondary servers, capture the current data store to a file called `/tmp/store`:**

```
# /opt/SUNWut/srds/lib/utldbmcats \
/var/opt/SUNWut/srds/dbm.ut/id2entry.dbb > /tmp/store
```

This provides an LDIF format file of the current data store.

2. **FTP this file to the `/tmp` directory on the primary server.**
3. **Follow the directions in the *Sun Ray Server Software 4.0 Installation and Configuration Guide* to install Sun Ray Server Software.**

4. After running `utinstall`, configure the server as a primary server for the group. Make sure that you use the same admin password and group signature.

```
# utconfig
:
# utreplica -p <secondary-server1> <secondary-server2> ...
```

5. Shut down the Sun Ray services, including the data store:

```
# /etc/init.d/utsvc stop
# /etc/init.d/utds stop
```

6. Restore the data:

```
# /opt/SUNWut/srds/lib/utldif21dbm -c -j 10 -i /tmp/store
```

This populates the primary server and synchronizes its data with the secondary server. The replacement server is now ready for operation as the primary server.

7. Restart Sun Ray services:

```
# utrestart -c
```

8. (Optional) Confirm that the data store is repopulated:

```
# /opt/SUNWut/sbin/utuser -l
```

9. (Optional) Perform any additional configuration procedures.

## ▼ To Replace the Primary Server with a Secondary Server

---

**Note** – This procedure is also known as promoting a secondary server to primary.

---

1. Choose a server in the existing failover group to be promoted and configure it as the primary server:

```
# utreplica -u
# utreplica -p <secondary-server1> <secondary-server2> ...
```

2. Reconfigure each of the remaining secondary servers in the failover group to use the new primary server.:

```
# utreplica -u  
# utreplica -s <new-primary-server>
```

This resynchronizes the secondary server with the new primary server.

---

**Note** – This process may take some time to complete, depending on the size of the data store. Since Sun Ray services will be offline during this procedure, you may want to schedule your secondary servers' downtime accordingly. Be sure to perform this procedure on each secondary server in the failover group.

---

## Secondary Server Recovery

Where a secondary server has failed, administration of the group can continue. A log of updates is maintained and applied automatically to the secondary server when it has recovered. If the secondary server needs to be reinstalled, repeat the steps described in the *Sun Ray Server Software 4.0 Installation and Configuration Guide*.

---

## Setting Up a Group Signature

The `utconfig` command asks for a group signature if you chose to configure for failover. The signature, which is stored in the `/etc/opt/SUNWut/gmSignature` file, must be the same on all servers in the group.

The location can be changed in the `gmSignatureFile` property of the `auth.props` file.

To form a fully functional failover group, the signature file must:

- be owned by root with only root permissions
- contain at least eight characters, in which at least two are letters and at least one is not

---

**Tip** – For slightly better security, use long passwords.

---

## ▼ To Change the Group Manager Signature File

1. As superuser of the Sun Ray server, open a shell window and type:

```
# /opt/SUNWut/sbin/utgroupsig
```

You are prompted for the signature.

2. Enter it twice identically for acceptance.
3. For each Sun Ray server in the group, repeat the steps, starting at step 1.

---

**Note** – It is important to use the `utgroupsig` command, rather than any other method, to enter the signature. `utgroupsig` also ensures proper internal replication.

---

## Taking Servers Offline

Being able to take servers offline makes maintenance easier. In an offline state, no new sessions are created. However, old sessions continue to exist and can be reactivated unless Sun Ray Server Software is affected.

### ▼ To Take a Server Offline

- At the command-line interface, type:

```
# /opt/SUNWut/sbin/utadm -f
```

### ▼ To Bring a Server Online

- At the command-line interface, type:

```
# /opt/SUNWut/sbin/utadm -n
```

## User Settings

---

This appendix covers topics that users as well as administrators may find useful. There are sections for:

- [“Supported Devices and Libraries” on page 187](#)
  - [“Sun Ray DTU Settings” on page 188](#)
  - [“Monitor Settings” on page 189](#)
  - [“Hot Key Preferences” on page 190](#)
  - [“Hot Key Values” on page 191](#)
  - [“Power Cycling a Sun Ray DTU” on page 193](#)
- 

## Supported Devices and Libraries

Sun Ray Server Software supports a wide variety of end-user devices, including mass storage and end-user peripherals that can be connected to a Sun Ray DTU’s serial, parallel, or USB ports; however, because of the growing number of USB devices available, it has not been possible to test all of them on Sun Ray DTUs.

### Supported Mass Storage Devices

Sun Ray Server Software 4.0 supports the use of flash disks, memory card readers, Zip drives, and hard drives on Sun Ray DTUs. It allows data CDs and DVDs to be read but not written. It does *not* support floppy drives.

For troubleshooting tips, please see [“Troubleshooting USB Mass Storage Devices” on page 217](#).

---

**Note** – Most devices claiming USB 2.0 compliance are backwards compatible and should work with Sun Ray Mass Storage.

---

## Sun Ray DTU Settings

Sun Ray Settings is an interactive GUI that allows the user to view and change the settings for the Sun Ray DTU that the user is currently logged into.

The Sun Ray Settings GUI contacts the Session Manager to determine which DTU is currently being used and connects to that unit to get the current values. The GUI maintains a connection to the Session Manager so that the Session Manager can notify the GUI if the user moves to another DTU by removing the smart card and inserting it into another DTU.

### ▼ To Change the Sun Ray Settings

1. Press the hot key (by default Shift-Props).

The Sun Ray Settings window is displayed.

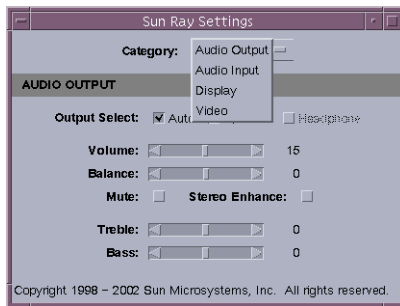

FIGURE A-1 Settings Screen

2. Use the Category pull-down menu to access Audio Output, Audio Input, Display, and Video settings.

3. To change a setting, move the appropriate scroll bar, checkbox, or pull-down menu.

The DTU is updated immediately.

The only exception is the “Resolution/Refresh Rate” setting, which prompts the user with confirmation dialog boxes before and after the change is made on the DTU.

4. Press the hot key to close the window.

---

**Note** – Only one instance per session of Sun Ray Settings runs in hot key mode.

---

## Monitor Settings

Sun Ray users can modify their screen resolution settings by invoking `utsettings`.

Any resolution selection made within a session remains effective whenever the session is displayed on that particular DTU. The selection is not lost if the unit goes into power-save mode or is power-cycled; however, the resolution settings selected through `utsettings` apply *only* to the DTU where `utsettings` is run.

When a user moves to another DTU, the resolution settings do not accompany the user to the new DTU, but the settings remain effective for the user’s session on the original DTU if the returns to it via hotdesking.

If the session is associated with a personal mobile token (a smart card or an NSCM credential), then `utsettings` offers to make the selected timing permanent. If a user accepts that offer, then the timing is retained and reused on that user’s subsequent personal mobile token sessions on the same DTU.

In addition, the administrator can use the `utresadm` command to:

- Arrange for a particular monitor timing to be used whenever a specific token is presented on a specific DTU.
- Arrange for a particular monitor timing to be used on a specific DTU, regardless of the token that is presented at the DTU.
- Arrange for a particular monitor timing to be used on all DTU’s regardless of the token that is presented at the DTU.

Any conflict among settings is resolved in favor of the most specific configuration rule. That is, a configuration record for a specific token at a specific DTU takes precedence over a record for *any token* at that specific DTU, and a configuration record for *any token* at a specific DTU takes precedence over a record for *any token* at *any DTU*.

For further details, see the `utsettings` and `utresadm` man pages.

---

# Hot Key Preferences

Hot keys can be configured for various Sun Ray utilities. The scope for these hot keys can be:

- System-wide default setting
- User default setting
- System-wide mandatory setting

To support these levels of customization, the utilities look for the properties files in [TABLE A-1](#), in the following order, at startup:

**TABLE A-1** Sun Ray Settings Properties Files

File	Scope	Description
<code>/etc/opt/SUNWut/utslaunch_defaults.properties</code>	System	This file contains helpful default properties. Any properties specified here override any defaults built into the application itself.
<code>\$HOME/.utslaunch.properties</code>	User	This file contains the user's preferred values, which override any application or site-wide defaults.
<code>/etc/opt/SUNWut/utslaunch_mandatory.properties</code>	Mandatory	This file contains site-wide mandatory settings that cannot be overridden by the user. These properties override any application, site-wide, or user defaults.

If your policy is for all DTUs to use a standard hot key, use the system-wide mandatory defaults file to specify this standard key. This prevents users from specifying their own hot key preferences.

The format of the hot key entry in these properties files is:

`<utility_name>.hotkey=value`



where *<utility\_name>* is the name of the utility, such as `utsettings` or `utdetach`, and *value* is a valid X keysym name preceded by one or more of the supported modifiers (`Ctrl`, `Shift`, `Alt`, `Meta`) in any order. Values are shown in [TABLE A-2](#).

**TABLE A-2** Specific Hot Key Values

Example Value	Notes
<code>Shift+Props</code>	Invoke the Settings GUI.
<code>Stop+S</code>	Invoke the Pop-up GUI
<code>Ctrl+Alt+Backspace</code>	Press this key sequence twice to kill a session.
<code>Ctrl+Alt+Del</code>	Press this key sequence twice to kill the process that has taken control of the X server.
<code>Shift+Pause</code>	This detaches a non-smart card mobility session.
<code>Mute+Softer+Louder</code>	Display the DTU's MAC address.
<code>Ctrl+Power</code>	Power cycle the DTU.

---

## Hot Key Values

### ▼ To Change the Hot Key for the Settings GUI

If you do not want to use `Shift Props` as your default hot key, use the system-wide defaults file to specify a function key. Users can still specify their preferences in the user defaults file.

Use this procedure to modify the settings GUI for all users on a server.

1. **As superuser, open the** `/etc/opt/SUNWut/utslaunch_defaults.properties` **file in a text editor.**

---

**Tip** – If you want to make the change mandatory, change the value in the `/etc/opt/SUNWut/utslaunch_mandatory.properties` file.

---

2. Locate the original hot key entry for the `utdetach` utility and place a # in front of that statement.

The # comments out the first hot key property.

```
# utdetach.hotkey=Shift Pause
```

3. Type in the new hot key property after the first statement. For example,

```
utsettings.hotkey=Shift F8
```

4. Save the `utslaunch_defaults.properties` file.

The new hot key takes effect when the next user logs in. The next user to log in uses the new hot key to display the Sun Ray Settings screen. Users who were logged in before you changed the hot key continue to use the old value.

## ▼ To Change the Hot Key Used to Detach NSCM Sessions

---

**Note** – This resembles the procedure for changing the hot key for the settings GUI except for Step 3.

---

1. As superuser, open the `/etc/opt/SUNWut/utslaunch_defaults.properties` file in a text editor.
2. Locate the original hot key entry for the `utsettings` utility and place a # in front of it to comment it out.

```
# utsettings.hotkey=Shift SunProps
```

3. Type in the new hot key property after the first statement. For example,

```
utdetach.hotkey=Alt F9
```

## ▼ To Change the Hot Key Setting for a Single User

1. In the user's home directory, create the `.utslaunch.properties` file.

---

**Note** – Make sure that the user owns and can read this file.

---

2. Add a line to the `.utslaunch.properties` file with the value for the hot key. For example:

```
utsettings.hotkey=Shift F8
```

3. Save the `.utslaunch.properties` file.
4. Log out and log back in to enable the new hot key.

---

**Note** – You can modify other hot keys in a similar fashion.

---

---

## Power Cycling a Sun Ray DTU

### ▼ To Power Cycle a Sun Ray DTU

- Disconnect then reconnect the power cord.

### ▼ To Perform a Soft Reset

- Use the key sequence `Ctrl-Power`. The Power key at the right side of the top row of a Sun Type 6 or Type 7 keyboard has a crescent moon icon; the soft reset key sequence is often called `Ctrl-Moon`.

### ▼ To Kill a User's Session

- Use the key sequence `Ctrl-Alt-Backspace` twice.

This kills the Xserver process, alerting the current session's parent process to start another session.



## Troubleshooting and Tuning Tips

---

This appendix contains the following sections:

- “Understanding OSD” on page 195
- “Authentication Manager Errors” on page 215
- “Troubleshooting USB Mass Storage Devices” on page 217
- “Audio” on page 218
- “Performance Tuning” on page 220
- “Troubleshooting the Sun Management Center” on page 224

---

**Note** – For the latest information regarding Sun Ray Server Software patches, check: <http://www.sun.com/software/sunray/patches.xml>  
Solaris operating environment patches and other software patches are available at: <http://access1.sun.com>

---

---

## Understanding OSD

Sun Ray Server Software on-screen displays (OSD) to help administrators and others identify problems visually. The most important information about the Sun Ray DTU and its current state is displayed on the screen.

### OSD Icon Topography

The original OSD supplied with earlier versions of Sun Ray Server Software and DTU firmware have now been replaced with larger icons that provide the same information in an easier to read format. It is always a good idea to make sure that you are using the latest firmware. See “[Managing Firmware Versions](#)” on page 31.

Both sets of OSD icons are composited live, based on the current state of connectivity at a given moment. Examples of the original OSD are shown at left in the figures below, with equivalent or similar examples of the newer OSD at the right.

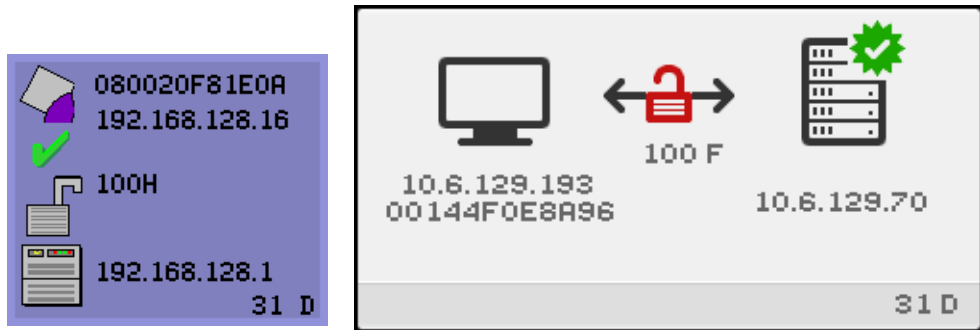

**FIGURE B-1** Layout of Old (left) and New (right) OSD Icons

The OSD icons display:

- Ethernet address
- Currently assigned IP address of the DTU
- Link status of the currently connected Sun Ray server
- Authentication Server IP address
- Icon code and DHCP state

To help you locate problems, the OSD icons display a numeric icon code followed by an alphabetic DHCP state code. You can look up the meaning of the numeric OSD message codes in [TABLE B-1](#) and the alphabetic DHCP state codes in [TABLE B-2](#), and firmware download error codes in [TABLE B-4](#). Encryption and authentication information is also displayed when appropriate.

Sun Ray DTUs can function in a private interconnect or in a simple LAN environment with only an IP address, but additional basic parameters and Sun Ray-specific vendor options are needed for more complex LAN operations, such as when a DTU is located several hops away from the Sun Ray Server's subnet.

OSD icon messages and codes are summarized in the following tables:

**TABLE B-1** Icon Messages

Icon Code Meaning	
1	Sun Ray DTU is starting up and is waiting for ethernet link
2	Sun Ray DTU is downloading new firmware
3	Sun Ray DTU is storing new firmware in its flash memory
4	Either the download or storage of new firmware has failed

**TABLE B-1** Icon Messages

<b>Icon Code Meaning</b>	
5	There is no session to connect with the Sun Ray
6	The server is denying access to the Sun Ray
7	Local pin entry to the smart card has failed
8	In local smart card pin entry mode
9	There is an over current condition on the USB bus, i.e., the total number of devices draws too much current. Consider using a powered hub.
11	Server is authenticated by the Sun Ray DTU and the graphic/keyboard network connection is encrypted
12	The Sun Ray DTU cannot authenticate the server but the graphic/keyboard network connection is still being encrypted
13	Server authenticated to the Sun Ray; network connection between Sun Ray and server not encrypted
14	Server not authenticated to the Sun Ray; graphic/keyboard network connection is not encrypted
15	the Sun Ray DTU is refusing to talk to the server due to the server's refusal or inability to authenticate or encrypt the network connection
16	The Sun Ray USB bus is temporarily busy servicing a high-speed device, and the keyboard or mouse may not be responsive to user input.
21	The Sun Ray DTU is booting up and is waiting on DHCP IP address and parameter assignment.
22	The Sun Ray DTU is booting up and is now waiting for the initial connection to a Sun Ray server.
23	The connection between the Sun Ray DTU and the network is down. Check the network drop cable and (if the network drop cable is okay) the network switch.
24	The Sun Ray DTU has disconnected from the previous server.
25	The Sun Ray DTU is being redirected to a new server.
26	The Sun Ray DTU has connected to the server and is waiting for graphics traffic.
27	The Sun Ray DTU is broadcasting to locate a Sun Ray server since either it was not provided with Sun Ray specific DHCP parameters or all of the specified servers are not responding.
28	VPN connection being attempted
29	VPN connection established
30	VPN connection error
<b>Icons 31 through 34 display network status when the three audio keys are pressed simultaneously.</b>	
31	The network link is up, the server is authenticated, and graphics/keyboard network connections are not encrypted.
32	The network link is up, the server is not authenticated, and graphics/keyboard network connections are encrypted.

**TABLE B-1** Icon Messages

Icon Code	Meaning
33	The network link is up, the server is authenticated and graphics/keyboard are encrypted.
34	The network link is up, the server is not authenticated and graphics/keyboard are not encrypted.
50	The server is refusing to talk to the Sun Ray DTU due to the Sun Ray's refusal or inability to authenticate or encrypt the network connection

**TABLE B-2** DHCP State Codes

DCHP State Code	Meaning
A	DCHP only provided IP address with no additional parameters.
B	DCHP provided IP address, subnet mask, and router, but Sun Ray vendor-specific parameters are missing.
C	DHCP provided IP address and Sun Ray vendor-specific parameters, but subnet mask and router are missing.
D	DHCP provided all expected parameters.
	<b>Codes E, F, H, and I are valid only with OSD icon 28</b>
E	VPN Phase 1 IKE initiated.
F	VPN Phase 1 IKE complete.
H	VPN Phase 2 initiated.
I	VPN Phase 2 complete.



**TABLE B-3** Power LED

<b>DTU Hardware State</b>	<b>Action to Take</b>
Off	Check to see if the DTU is plugged in. Replace the DTU.
Amber	Hardware fault. Replace the DTU.
Blinking	PROM is corrupted. Check that firmware downloads are properly configured and enabled, then power cycle the DTU.
Card reader LED remains on even when smart card is removed	Card reader hardware problem. Replace the DTU.

**TABLE B-4** Firmware Download Error Codes and Messages

<b>Error Code</b>	<b>Error Message</b>
E	FW Load: No server
F	FW Load: Name too long
G	FW Load: Bad read
H	FW Load: Bad signature
I	FW Load: Failed decompression
J	FW Load: Invalid module type
K	FW Load: Version mismatch
L	FW Load: Not enough memory
M	FW Load: Prevented by barrier
N	FW Load: Invalid HW version
O	FW Load: Flash write error

# Sun Ray Desktop Unit Startup

The first display a user should see is depicted below:

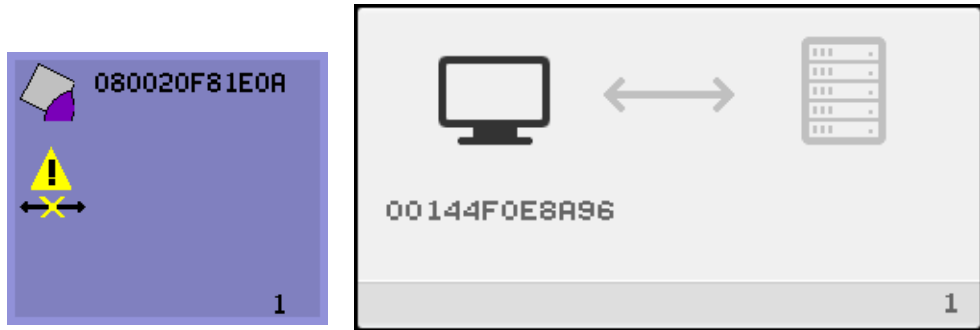

**FIGURE B-2** DTU Startup OSD

This icon indicates that the DTU has passed the power-on self test but has not detected an Ethernet signal yet. This icon is displayed as part of the normal startup phase and is usually displayed for only a few seconds.

## ▼ If this icon stays on for more than 10 seconds

1. **Check that the Ethernet cable is correctly plugged into the DTU and the other end is plugged in to the correct hub, switch, or network outlet.**

A link light on the switch or hub indicates that the connection is alive.

2. **If the DTU is connected through a hub or a switch, make sure that the hub or switch is powered on and configured correctly.**

After the Sun Ray DTU has verified its network connection, the user should see this OSD:

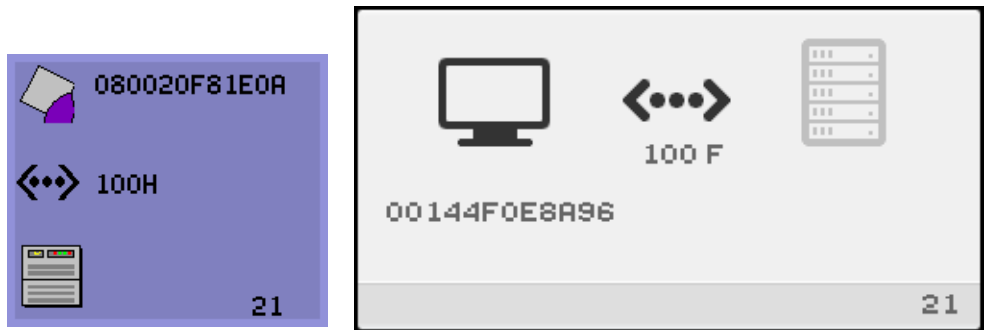

**FIGURE B-3** Network Connection Verified

This icon indicates that the DTU has detected the Ethernet carrier but has not yet received its initial parameters or IP address from DHCP. This icon is displayed as part of the normal startup phase and is usually displayed for only a few seconds.

### ▼ If this icon stays on for more than 10 seconds

1. **Make sure that the DHCP server is configured correctly, is up and running, and has not run out of IP addresses to assign to clients.**
2. **Verify that your DHCP server is configured properly for network parameters.**

After the DHCP server has allocated an IP address, the icon is updated with the unit's IP address; if the response is inadequate, the Sun Ray DTU issues a DHCP `inform` request to attempt to obtain the Sun Ray vendor-specific parameters. The Sun Ray DTU continues all the way through booting with just a DHCP supplied IP address but usually functions better with some additional parameters.

At this point, depending on whether you have configured your Sun Ray servers to run on a LAN or a dedicated interconnect, OSD 21A or 21B may display.

Code 21 A indicates that the DTU got an IP address and is waiting for a DHCP `inform` response to other parameters.

Code 21 B indicates that the DTU got an IP address and IP router and is waiting for Sun Ray vendor-specific options from DHCP `inform`.

---

**Note** – If you see a 21 A or 21 B with a DTU IP address in a LAN deployment, the Sun Ray DTU is trying to use DHCP `INFORM` to get Sun Ray-specific parameters.

---

## ▼ Actions to Take

1. For LAN configurations with other (non-Sun Ray) DHCP services but no `bootp` proxy agent, verify the DHCP server and the Sun Ray vendor tags.
2. For routed configurations, verify that the `bootp` proxy agent is configured correctly in the Sun Ray DTU's subnet and that it points to one of the Sun Ray servers in the failover group.
3. For non-routed private interconnect configurations, the Sun Ray server also performs the functions of a DHCP server. Verify that it is configured properly for DHCP services.

When DHCP finishes, the Sun Ray DTU tries to connect to a Sun Ray server and the Authentication Manager running on it.

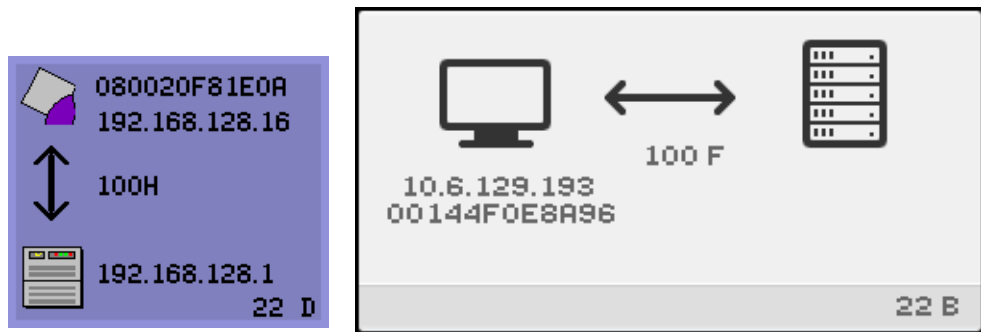

FIGURE B-4 Waiting to Connect to Authentication Manager

This icon indicates that the DTU has received its initial parameters from DHCP but has not yet connected to the Sun Ray Authentication Manager. This icon is displayed as part of the normal startup phase and is usually displayed for only a few seconds.

## ▼ If the icon displays for more than a few seconds or if the DTU continues to reset after the icon is displayed

1. Make sure that Sun Ray services, including the Authentication Manager, are up and running on the Sun Ray server.

In a LAN configuration or other routed environment:

2. Make sure that the Authentication Manager can be reached from the IP address assigned to the DTU.
3. Verify that the routing information the DTU receives is correct.
4. Run `utquery` for the DTU's IP address.

The `utquery` command displays the parameters a Sun Ray DTU has received. If `utquery` fails to display an `AuthSrvr` parameter, the DHCP server for Sun Ray parameters may not be reachable or may not be configured properly. Confirm that the `DHCPServer` and `INFORMServer` values are appropriate. If not, look at your `bootp` relay configurations and DHCP server configurations for network and Sun Ray parameters. For details of these parameters, see the `utquery` man page.

---

**Note** – To Restart DHCP on a Solaris server, type the following as superuser:

```
# /etc/init.d/dhcp stop
# /etc/init.d/dhcp start
```

---

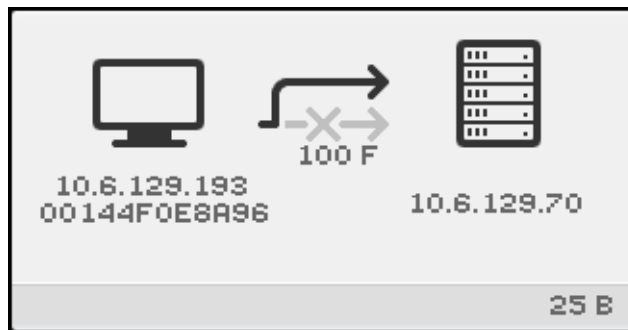

**FIGURE B-5** Redirection OSD

This OSD indicated that the DTU is being redirected to a new server. This can occur for any of several reasons, including load balancing.

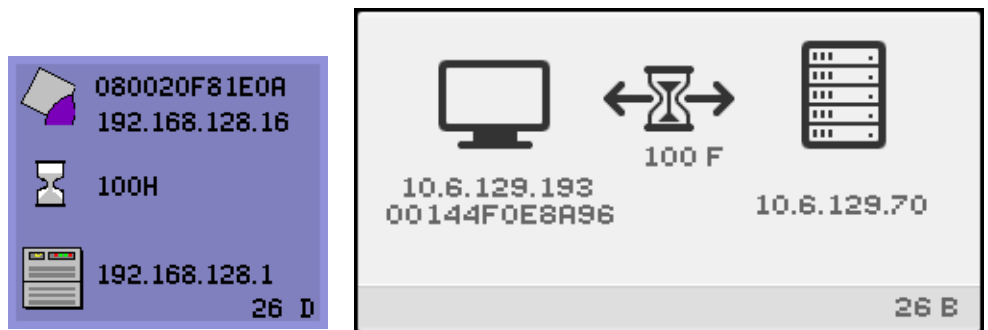

**FIGURE B-6** Wait for Session OSD

This OSD represents the transition state for the Sun Ray DTU. If it is displayed for an extended period, there is probably no X Window server running.

---

**Note** – The current wait icon is a white “X” cursor. In earlier releases, the wait icon was displayed as a green newt cursor.

---

**Tip** – If you suspect that the configuration files have been corrupted, please see [“Determine the Integrity of the Configuration Files”](#) on page 51 in the *Sun Ray Server Software 4.0 Installation and Configuration Guide*.

---

## Wait Icon Cursor for Default Session Type

This section applies to a normal `dtlogin` session.

The Xsun server is indirectly started by the `dtlogin` daemon. In the process of starting the Xsun server, the `dtlogin` daemon reads two configuration files:

- `/etc/dt/config/Xservers`
- `/etc/dt/config/Xconfig`

If, after several retries, the Xsun process does not start, the `dtlogin` daemon just gives up. The problem can usually be traced back to an older version of the `dtlogin` daemon or the configuration files for the `dtlogin` daemon.

The `dtlogin` daemon has been part of the Solaris operating environment since long before Sun Ray Server Software existed. The Sun Ray administration model uses the `dtlogin` daemon in new ways, and certain bugs in the `dtlogin` daemon have become apparent. Patches to fix these bugs in the `dtlogin` daemon are available.

### ▼ To Identify a Hung Session

- As superuser, type:

```
# /opt/SUNWut/sbin/utdesktop -l -w
```

### ▼ To Kill a Hung Session

- As superuser, type:

```
# /opt/SUNWut/sbin/utsession -k -t token
```

## ▼ Actions to Take

1. Check the messages file `/var/opt/SUNWut/log/messages` to verify the version number.
2. Correct, if necessary, with `utadm -l`.

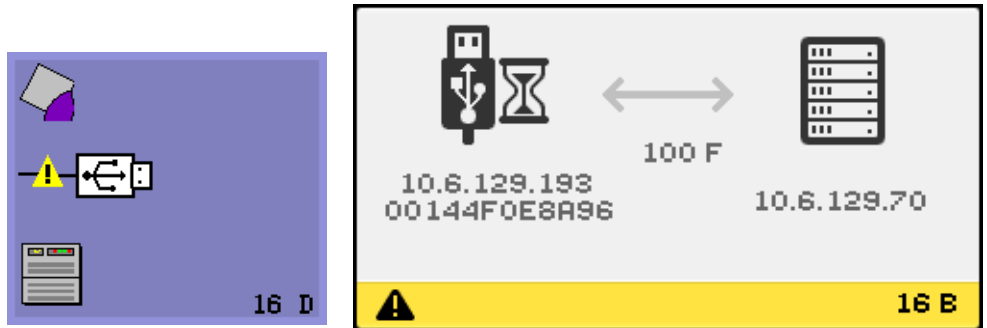

FIGURE B-7 Bus Busy

This icon indicates that the Sun Ray USB bus is temporarily busy servicing a high-speed device, and the keyboard or mouse may not be responsive to user input.

This icon typically appears only during an unusually long print job and disappears when the job is done. This is an informational OSD; there is no particular action to take unless it is necessary to kill the print job.

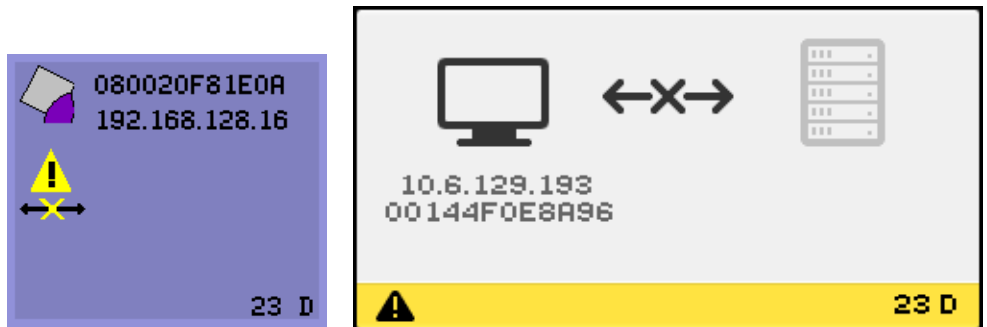
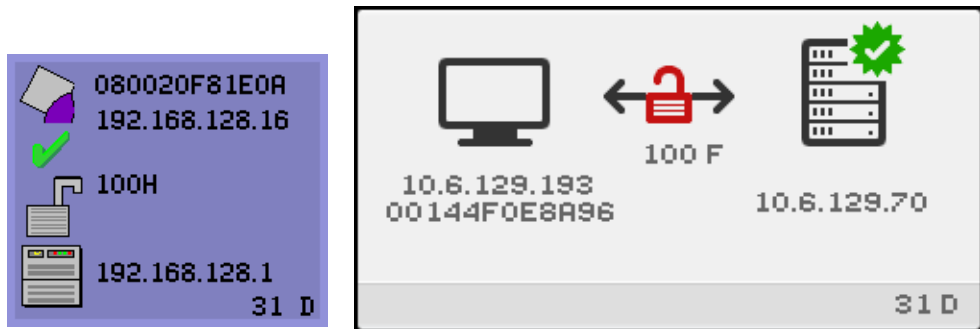

FIGURE B-8 No Ethernet Signal

This icon indicates that the DTU has an Ethernet address and an IP address but has lost the Ethernet signal. This icon is displayed only after the DTU successfully boots and receives an IP address, but then loses its Ethernet signal.

## ▼ Actions to Take

1. Check that the Ethernet cable is correctly plugged in to the back of the DTU and the other end is plugged into the correct switch or network outlet.
2. If the DTU is connected through a hub or switch, make sure that the hub or switch is on and configured correctly.



**FIGURE B-9** Ethernet Address

This OSD shows the Ethernet address, currently assigned IP address, currently connected server, encryption status, DHCP state, and link speed and mode. 10 stands for 10 Mbps, and 100 for 100 Mbps. F stands for full duplex, H stands for half-duplex mode. To display this OSD with current information, press the three audio volume keys simultaneously.

---

**Tip** – To get the same effect on non-Sun keyboard, disconnect and reconnect the Ethernet cable.

---



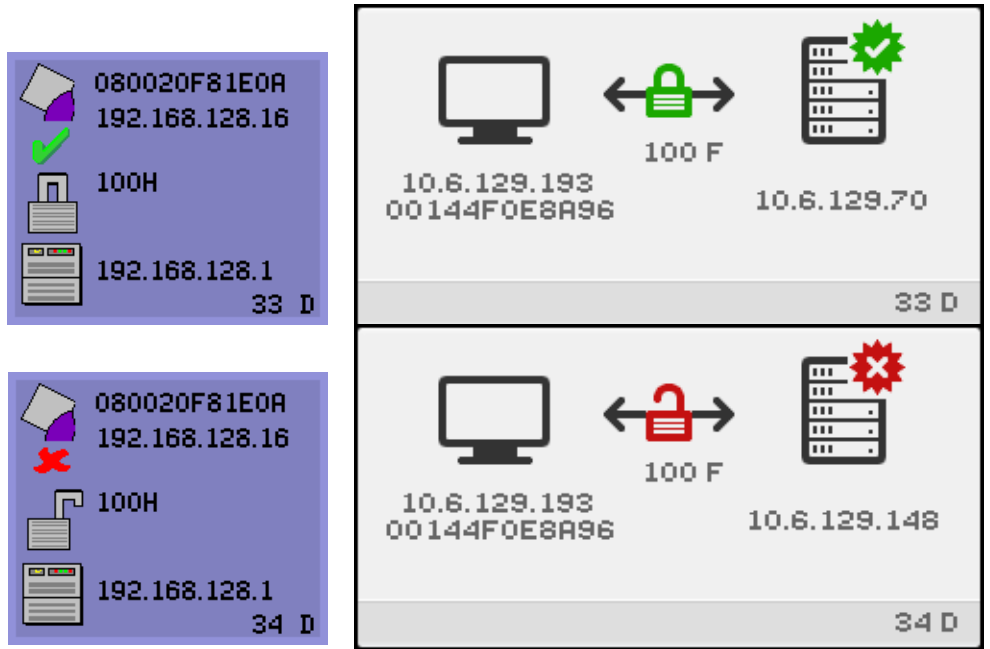

**FIGURE B-10** Ethernet Address OSD with Different Encryption and Authentication States

## Session Connection Failures

The following icons are displayed in the event of a possible security breach.



**FIGURE B-11** Session Refused by Client

This icon indicates that the client is refusing to connect to a server because it is unable to verify the validity of the Sun Ray server. This error can occur only if an unknown Sun Ray server intercepts the messages and tries to emulate a valid Sun Ray server. This is a session security breach.

A graphically similar icon displaying the number 50 indicates that the server is refusing to grant a session to the client because the client is unable to fulfill the server's security requirements.

## ▼ Actions to Take

### 1. Check the client's firmware version.

This error may occur with firmware versions earlier than 2.0 if the server is configured for hard security mode.

### 2. Upgrade the firmware.

As an alternative, confirm whether your site requires hard security mode. If not, the session can be enabled with soft security mode.

The following icon is displayed if the DTU is broadcasting to locate a server and either no servers respond or Sun Ray specific DHCP parameters have not been supplied correctly.



FIGURE B-12 DHCP Broadcast Failure

The following icon is displayed while a DTU is trying to establish a VPN connection.



**FIGURE B-13** Establishing a VPN Connection

When the VPN connection is established, the following icon is displayed.

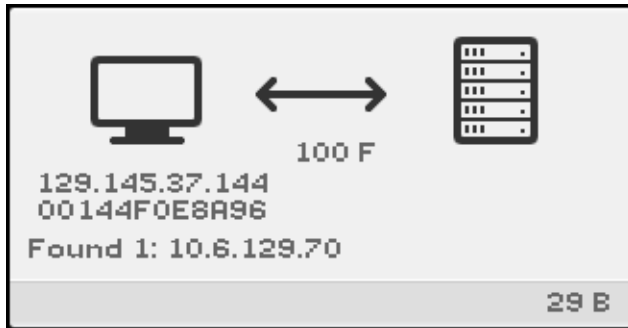

**FIGURE B-14** VPN Connection Established

## Firmware Download Diagnostics

When firmware download error occurs, OSD icon 4 (see [FIGURE B-15](#)) displays the appropriate error code and a descriptive text string. These error codes are listed in [TABLE B-4](#).

---

**Note** – These error messages appear in English even in localized versions of Sun Ray Server Software.

---



FIGURE B-15 OSD Icon 4 Displays Firmware Download Error Messages

## Firmware Download OSD

The following OSD are typical of those that may display when new firmware is downloaded to a DTU from a Sun Ray server.

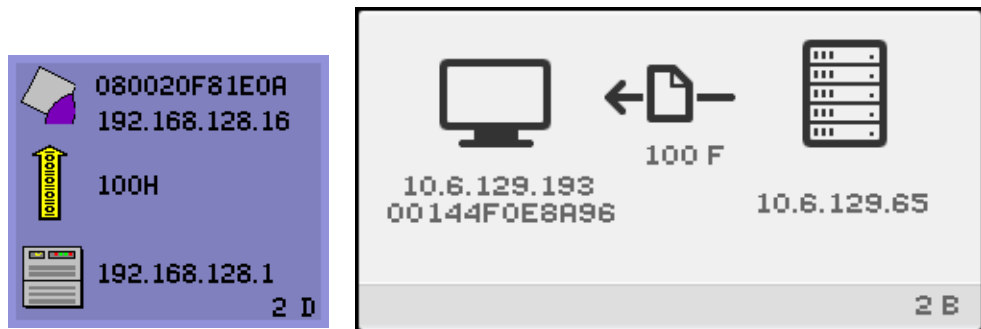

FIGURE B-16 Firmware Download in Progress

This icon indicates that the DTU is currently downloading new flash PROM software from the Sun Ray server.

## ▼ Actions to Take

### 1. Wait until the download is complete.

Downloading and saving the new PROM software usually takes less than a minute. If you interrupt the download, the DTU has to download new PROM software the next time it reboots.

If the firmware download fails, the following syslog message indicates that the barrier level has been set to prevent Sun Ray DTUs with SRSS 4.0 firmware from automatically downloading an earlier version of the firmware:

```
Firmware upgrade/downgrade not allowed! Barrier is 310 Firmware level is 0
```

2. **Check** `/var/opt/SUNWut/log/messages` to confirm that your configuration is set up properly.

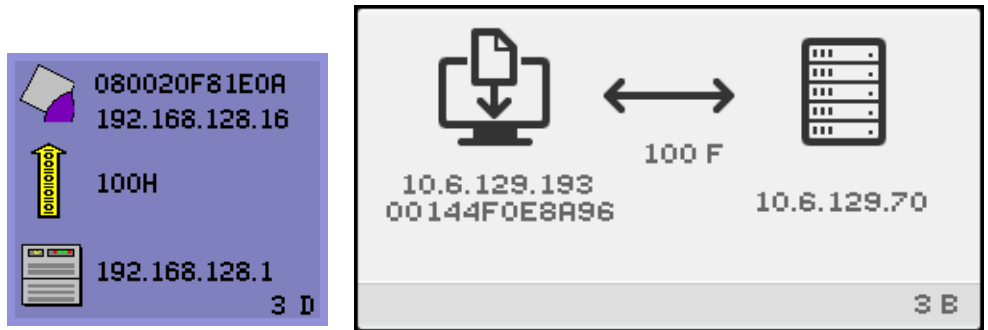

**FIGURE B-17** Saving PROM Software

This icon indicates that the DTU has just downloaded new PROM software from the Sun Ray server and is saving it to the DTU's PROM.

## ▼ Actions to Take

- **Wait until the download is done.**

Downloading and saving the new PROM software usually takes less than a minute. If you interrupt the download, the DTU has to download new PROM software the next time it reboots.

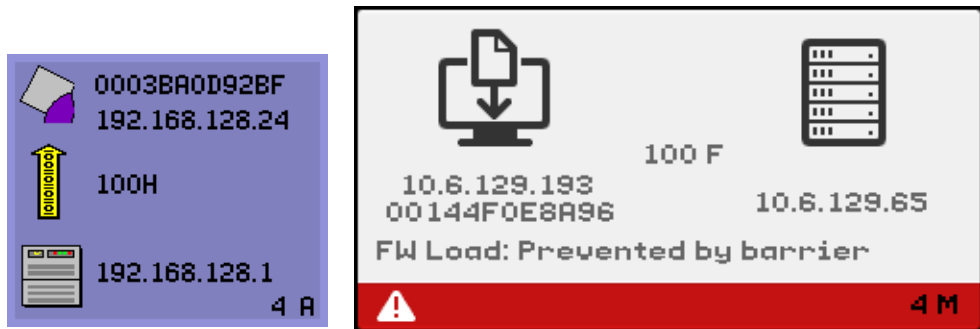

**FIGURE B-18** Firmware Download Failed

This icon indicates that the DTU has failed to download new firmware. OSD 4 now includes error code text, as shown above.

## Token Reader Icons

When a site policy disallows pseudo-sessions, DTUs configured as token readers display the Card Reader icon instead of the Login Dialog box card.

---

**Note** – The token reader was called the card reader in earlier releases. The smart card token itself is an integrated circuit embedded in or printed on the card, and it is data on the token that is read when a user inserts a card. In practice, the terms card reader and token reader are used interchangeably.

---



**FIGURE B-19** Card Reader OSD

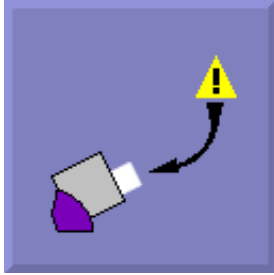

**FIGURE B-20** Card Read Error OSD

This icon indicates that the Card Read Error OSD icon appears whenever the firmware is unable to read the card due to one of the following causes:

- The DTU is running old firmware.
- The card contacts are dirty, the contacts on the card reader are dirty, or the card is not properly inserted.
- The card is malfunctioning.
- The card is of a type that the firmware is not configured to read.
- There is an error in the configuration for reading this type of card.

## ▼ Actions to Take

1. Upgrade the firmware.
2. Replace the card.



**FIGURE B-21** Prompt for Card Insertion OSD

If the current authentication policy allows access only by card, this OSD icon appears and prompts the user to insert a card.



**FIGURE B-22** Access Denied OSD

This icon indicates that the Access Denied OSD icon appears when the current authentication policy denies access to the presented token. Specifically, this icon is displayed if a disabled card has been inserted into a DTU.

The Sun Ray administration model has seven user session types:

- Default—Normal user login
- Register—User self-registration
- Kiosk—Anonymous user operation
- Insert card—User smart card required
- Card error—Unrecognized user smart card type
- No entry—User's smart card token is blocked
- Session Refused—The server refuses to grant a session to a client that does not meet the server's security requirements

The first three session types have normal login processes. When there is a problem, the administrator should examine:

- Sun Ray Server configuration files

---

**Caution** – Sun Ray Server Software modifies certain system configuration files. In most cases, these changes are identified with SRSS-specific comments. Please do not change these modifications.

---

- Any locally modified X server startup files
- `dtlogin` status

Although the last four session types display icons on the Sun Ray DTU, they do not have login processes at all. The icons indicate that the user must take steps before a successful login is possible. If the user immediately removes and reinserts the smart card, the icon disappears, but the Wait for Session OSD remains.

These last four session types and their OSDs should not cause alarm. The user can:

- Insert a recognized smart card in the correct orientation
- Ask the Sun Ray administrator to grant access
- Ask the Sun Ray administrator to download the correct firmware



---

# Authentication Manager Errors

Authentication Manager errors can be found in the following error logs:

- Installation logs:
  - `/var/adm/log`
  - `/var/opt/SUNWut/log`
- General log files:
  - `/var/opt/SUNWut/srds/log`
  - `/var/opt/SUNWut/srds/replug`

The general format of the log messages is:

```
timestamp    thread_name    message_class    message
```

For example:

```
May  7 15:01:57 e47c utauthd: [ID 293833 user.info] Worker3
NOTICE: SESSION_OK pseudo.080020f8a5ee
```

Message components are defined as follows:

- `timestamp` format:  
*year.month.day hours:minutes:seconds*
- `thread_name`

There are several different types of threads. The most common thread handles DTU authentication, access control, and session monitoring. These threads are named “worker” plus number. The Worker# thread names are reused when a connection terminates. Other threads are:

  - `SessionManager#`—Communicate with `utsessiond` on behalf of a Worker# thread.
  - `AdminJobQ`—Used in the implementation to wrap a library that would not otherwise be thread-safe.
  - `CallBack#`—Communicate with applications such as `utload`.
  - `WatchID`—Used to poll data/terminals from connections
  - `Terminator`—Cleans up terminal sessions
  - `Group Manager`—Main group manager thread
- `message_class`

Messages with the same thread name are related. The exception occurs when a Worker# thread disconnects a DTU and then purges the connection information from memory. After a Worker# DESTROY message, the next use of that Worker# thread name has no relation to previous uses of the thread name (in other words, the thread names are reused).

- CLIENT\_ERROR—Indicates unexpected behavior from a DTU. These messages can be generated during normal operation if a DTU is rebooted.
- CONFIG\_ERROR—Indicates a system configuration error. The Authentication Manager generally exits after one of these errors is detected.
- NOTICE—Logs normal events.
- UNEXPECTED—Logs events or conditions that were not anticipated for normal operation but are generally not fatal. Some of these errors should be brought to the attention of the Sun Ray product development team.
- DEBUG—Only occurs if explicitly enabled. Beneficial to developers. Debug messages can reveal session IDs, which must be kept secret to ensure proper security.

**TABLE B-5** Error Message Examples

Error class	Message	Description
CLIENT_ERROR	...Exception ... : cannot send keepAliveInf	Error encountered while attempting to send a keep-alive message to a DTU.
	...keepAlive timeout	A DTU has failed to respond within the allotted time. The session is being disconnected.
	duplicate key:	DTU does not properly implement the authentication protocol.
CONFIG_ERROR	invalid key:	DTU does not properly implement the authentication protocol.
	attempt to instantiate Callback 2nd time.	Program error.
	AuthModule.load	Problem encountered while loading configuration module.
NOTICE	Cannot find module	Program or installation error.
	"discarding response: " + param	No controlling application is present to receive DTU response.
	"NOT_CLAIMED PARAMETERS: " + param	A token was not claimed by any authentication module.
	...authentication module(s) loaded.	Notification that authentication modules have loaded.
	...DISCONNECT ...	Normal notification of disconnection.

**TABLE B-5** Error Message Examples (*Continued*)

Error class	Message	Description
UNEXPECTED	"CallBack: malformed command"	Bad syntax from a user application such as utload or utidle.
	.../ ... read/0:" + ie	Possible program error.
	.../ ... read/1: ... Exception ...	Error encountered while reading messages from the DTU.
	.../... protocolError: ...	Various protocol violations are reported with this message. This is also a way for utauthd to force the DTU to reset.

---

## Troubleshooting USB Mass Storage Devices

The most common problems encountered with USB mass storage devices on Sun Ray DTUs are described in the following sections.

### Device Nodes Are Not Created

Some mass storage device types are not supported on Sun Ray. Inspect the log file `/var/opt/SUNWut/log/utstoraged.log` for an indication as to why device nodes were not created.

### Device Is Not Automatically Mounted

If the storage medium does not have a OS-recognizable file system, it will not get automatically mounted. An error message will be logged to:  
`/var/opt/SUNWut/log/utmountd.log`

## Device Is Not Automatically Unmounted

If the device is unplugged, or if the user's session is disconnected from the DTU, all mount points for that DTU are automatically unmounted unless the user has open references to the mount point. In that case, the mount point becomes stale. A stale mount point persists until the administrator unmounts it manually or until the system is rebooted.

Run the following command to find stale mount points.

```
# /opt/SUNWut/bin/utdiskadm -s
```

---

**Note** – Close all references to the mount point or terminate all processes that refer to the mount before running the `umount` command.

---

---

## Audio

Each time a user logs in to a Sun Ray DTU, a script automatically assigns the `$AUDIODEV` environment variable to that session. One `utaudio(1)` real-time process is assigned to each session. Refer to the `audio(7i)` man page for more information.

## Audio Device Emulation

The emulated audio device follows the user session during hotdesking. The device name appears in the `$AUDIODEV` environment variable but is transparently interpreted by audio programs for Sun systems. Device nodes are created in the `/tmp/SUNWut/dev/utaudio` directory. The directory tree is completely recreated at boot time.



---

**Caution** – Do not remove the `/tmp/SUNWut/dev/utaudio` directory. Deleting this directory prevents existing users with `utaudio` sessions from using their audio pseudo device nodes.

---

If your application uses `/dev/audio`, the Sun Ray server software reroutes the audio signal appropriately.

# Audio Malfunction

If audio features are malfunctioning:

1. To confirm whether audio is working, run the following command on the DTU:

```
% cat <audio file> >/$AUDIODEV
```

2. Bring up `utsettings`:

```
% utsettings
```

3. Verify that audio output is selected properly, for example, for headphones or speakers.
4. Check the volume level.
5. Verify that Mute is not selected.

Some applications are hard-coded to use `/dev/audio` for output. Sun Ray System Software provides a redirection library that you can use to correct this behavior.

## ▼ To Activate the Redirection Library

1. Set the environment variable `LD_PRELOAD` to `libc_ut.so` in the shell or wrapper from which you started the audio player:

```
# setenv LD_PRELOAD libc_ut.so
```

2. Restart the application.

---

# PDA Synchronization Issues

If your users have problems running `PDASync` on a Sun Ray DTU:

1. Get the latest Java Communications API (javax.comm api version 3 or later) from

<http://java.sun.com/products/javacomm/>

**2. Make sure that you are using a supported USB-serial adapter.**

A list of supported USB devices is available at:

[http://www.sun.com/io\\_technologies/sunray/usb/](http://www.sun.com/io_technologies/sunray/usb/)

**3. Click the change Synchronization Settings icon.**

Select the port to which the Palm cradle is connected.

**4. Click OK.**

---

**Tip** – If the ports are not shown correctly in the Serial Port drop-down menu, close the application and hot plug the device, then start the application again.

---

For setup instructions, see [“PDA Synchronization” on page 63](#).

---

## Performance Tuning

Some applications, such as intensive 3-D visual simulations, may run very slowly on Sun Ray. Other applications, such as pseudo-stereo viewers using double-buffering, or high-frequency dynamic color table flips on 8-bit visuals, do not produce the expected visual result.

## General Configuration

You can usually improve performance by configuring `/etc/system` shared memory segment parameters. The exact settings depend on application demands and the number of Sun Ray users, but a convenient starting point is:

```
set shmsys:shminfo_shmmax = 0x2000000
set shmsys:shminfo_shmmni = 0x1000
set shmsys:shminfo_shmseg = 0x100
```

Due to the nature of the Xinerama (single virtual X display) mode of multihead, the system shared memory requirements may be even higher. To get reasonable performance, the `shmsys:shminfo_shmmax` parameter must be at least:

```
LARGEST_NUMBER_OF_HEADS * width * height * 4
```

# Applications

Placing the user's interactive applications, such as Netscape or StarOffice, or PC interoperability tools, such as Citrix or Tarantella, on the Sun Ray server usually helps performance by reducing network load. The applications benefit from faster transport of commands to the Sun Ray's X server.

Applications that can be configured to use shared memory instead of DGA or OpenGL usually perform better on Sun Ray when they used shared memory.

# Sluggish Performance

Sluggish Sun Ray server performance or excessive disk swapping is an indication that the Sun Ray server is under-provisioned. Under these circumstances, there is not enough virtual memory available to start an X Window server instance for a user's session.

The solution in this situation is to add more memory or increase the size of the swap partition. In other situations, network load or packet loss may be too high. In very rare cases, network cables or switch equipment may be defective.

1. **To determine whether there is excessive swapping, use `vmstat 5`.**

```
# vmstat 5
```

If there is excessive swapping, the system may be undersized or overutilized.

2. **Verify that network connections are 100F.**
3. **Use `utcapture` to assess network latency and packet loss.**

As latency and packet loss increase, performance suffers.

# Screensaver Resource Consumption

Many graphics-intensive screensaver programs consume large amounts of CPU, memory, and network bandwidth. To avoid excessive resource consumption, they should be disabled on Sun Ray servers.

## ▼ To Disable Screensaver Hacks on Solaris Systems

- Remove the packages that contain the screensaver hacks:

```
pkgrm SUNWxscreensaver-hacks
```

- On machines that have the `SUNWxscreensaver-hacks-gl` package installed, modify the `pkgrm` command as follows:

```
pkgrm SUNWxscreensaver-hacks-gl
```

---

**Note** – It may be necessary to remove the `gl` (graphics library) package first.

---

## Multihead Displays

For information on multihead displays, please see [“Multihead Administration” on page 141](#).

---

**Note** – The Sun Ray 2FS is designed to run a single display across two screens without additional configuration. It utilizes a single frame buffer for two displays, always treating two attached heads as a single, unified display surface to be controlled with a single mouse and keyboard, and always presenting itself to the X server as a single screen.

---

## Monitor Display Resolution Defaults to 640 x 480

First, eliminate the most obvious possible causes:

- An older monitor
- A bad cable
- Monitor was off when the Sun Ray DTU was started

If the Sun Ray DTU is unable to read DDC data from the monitor, then it defaults to 640 x 480 pixels.

## ▼ To Correct or Reset the Screen Resolution

1. Replace the cable



2. Restart the Sun Ray DTU after powering the monitor on
3. Replace the monitor
4. Use the `utresadm` to set persistent display setting to override the default.

## Old Icons (Hourglass with Dashes Underneath) Appear on Display

If the old icons appear on the display, either the DTU's firmware has not been upgraded or it is failing.

1. Upgrade the firmware to SRSS 4.0.
2. Follow the procedure to upgrade the firmware. See the *Sun Ray Software 4.0 Installation and Configuration Guide*.

You may need to use a dedicated private network.

## Port Currently Owned by Another Application

If this message displays, use the following procedure to correct it:

1. Download the latest Java Communications API (javax.comm API version 2.0.2 and above)
2. Make sure that the supported USB-Serial Adapter is used.  
The supported USB devices list is available at  
[http://www.sun.com/io\\_technologies/sunray/usb/](http://www.sun.com/io_technologies/sunray/usb/)
3. Click the Change Synchronization Settings icon and select the appropriate port (to which the Palm cradle should be connected), then click OK.
4. If the ports are not correctly shown in the Serial Port drop down menu, close the application and hot plug the device.
5. Start the application again.

## Design Tips

- Avoid drawing into off-screen memory and then copying large areas to the screen. This technique produces slow Sun Ray performance.
- GXcopy mode is usually the fastest drawing mode.

- To display large images, use shared memory pixmaps, if possible.
- Opaque stipple patterns are faster than transparent stipples.
- Opaque (image) text is faster than other text.

---

## Troubleshooting the Sun Management Center

Usually, if all the software is installed, the agent for Sun Ray monitoring starts automatically.

### No Sun Ray Object

If the Sun Ray server has the Sun Management Center agent component installed, but the Detail window shows no Sun Ray object for the Sun Ray server node, load the Sun Ray module:

#### ▼ To Load the Sun Ray Module

1. **Click the Modules tab.**

Note where the Sun Ray module is listed (if it is not listed, see [“No Sun Ray Module” on page 225](#)). For the module to be loaded, it should be listed in Modules with Load Status. In addition, it should be loaded and enabled.

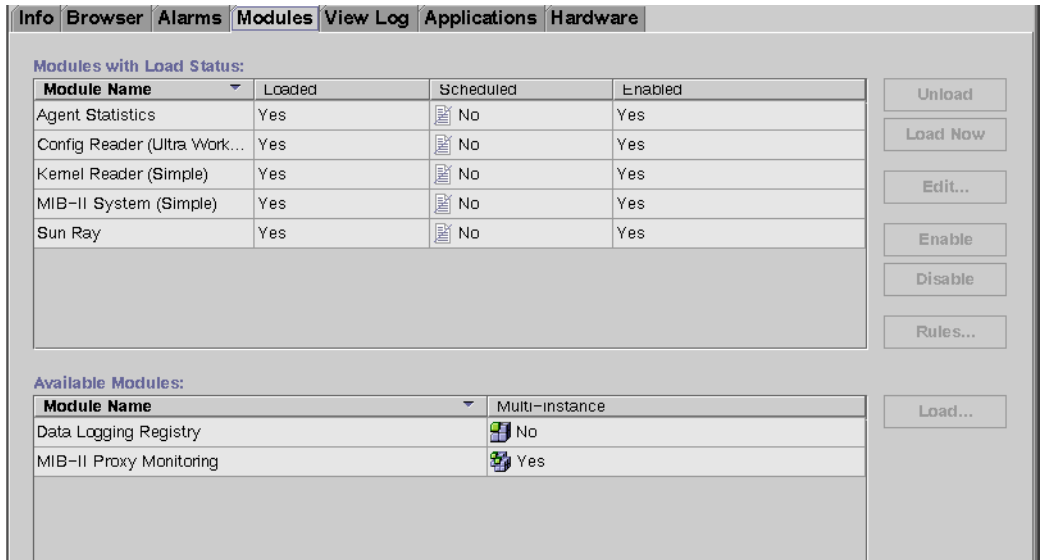

**FIGURE B-23** Module Panel

2. If the Sun Ray module is listed, highlight it and then click the Load button. This loads the module and moves it to the Modules with Load Status list.
3. If the Sun Ray module is disabled, highlight it and then click the Enable button. This enables the module.
4. Return to the Detail window. The Detail window shows a Sun Ray object for the Sun Ray server node.

## No Sun Ray Module

If, after clicking the Modules tab on the Details window of the Sun Ray server node, the Sun Ray module is not listed, activate the Sun Ray module:

## ▼ To Activate the Sun Ray Module

1. Register the module by typing:

```
# /opt/SUNWut/sbin/utsummc
```

This command adds the module to the Sun Management Center and restarts the agent if it is active.

2. If you receive the following message, perform steps 3 and 4.

```
Starting the SunMC agent...
NOTICE:          SunMC agent failed to start.
                 To start it manually run the command
```

3. Check to see if the agent is running:

```
# ps -ef |grep agent
```

If the Sun Management Center agent is running, wait then check the Detail window.

4. If the agent is not running, type the following to start it:

```
# /opt/SUNWsymon/sbin/es-start -a
```

# Glossary

---

---

## A

- AMGH** Automatic Multigroup Hotdesking. See [regional hotdesking](#).
- AH** Authentication headers, used as part of an IPSec implementation.
- authentication policy** The Authentication Manager, using the selected authentication modules, decides what tokens are valid and which users, as token owners, have access to the system and sessions.
- authentication token** Although all tokens are used by the Authentication Manager to grant or deny access to Sun Ray sessions, this term usually refers to a user's smart card token.

---

## B

- backplane bandwidth** Sometimes also referred to as switch fabric. A switch's backplane is the pipe through which data flows from an input port to an output port. Backplane bandwidth usually refers to the aggregate bandwidth available amongst all ports within a switch.
- barrier mechanism** To prevent clients from downloading firmware that is older than the firmware they already have, the administrator can set a barrier mechanism. The barrier mechanism symbol `BarrierLevel` is defined by default in the DHCP table of Sun Ray servers running version 2.0 or later of Sun Ray Server Software.
- bpp** Bits per pixel.

---

## C

- CAM** Controlled Access Mode, also known as *kiosk mode*. As of SRSS 4.0, the CAM module has been replaced by a rewritten Kiosk module.
- category 5** The most common type of wiring used in LANs. It is approved for both voice and data (at up to 100Mhz). Also called cat 5.
- client-server** A common way to describe network services and the user processes (programs) of those services.
- cold restart** Pressing the Cold Restart button terminates all sessions on a given server before restarting Sun Ray services. See *restart*.
- cut-through switches** The switch begins forwarding the incoming frame onto the outbound port as soon as it reads the MAC address, while it continues receiving the remainder of the frame.

---

## D

- DHCP** Dynamic Host Configuration Protocol, which is a means of distributing IP addresses and initial parameters to the DTUs.
- domain** A set of one or more system boards that acts as a separate system capable of booting the OS and running independently of any other board.
- DTU** Sun Ray desktop units were originally known as Desktop Terminal Units.

---

## E

- ESP** Encapsulating Security Payloads, used as part of *IPSec*.
- Ethernet** Physical and link-level communications mechanism defined by the IEEE 802.3 family of standards.
- Ethernet address** The unique hardware address assigned to a computer system or interface board when it is manufactured. See *MAC address*.

**Ethernet switch** A unit that redirects packets from input ports to output ports. It can be a component of the Sun Ray interconnect fabric.

---

## F

**failover** The process of transferring processes from a failed server to a functional server

**failover group** Two or more Sun Ray servers configured to provide continuity of service in the event of a network or system failure.

**filling station** When a client's firmware is downgraded to an earlier version because it connects to a server running the earlier version, it needs to be connected to a filling station so that it can download newer firmware. For this purpose, a filling station can be any private network configured for Sun Ray services or any shared network in which the Sun Ray DHCP server is the only DHCP server.

**firmware barrier** See *barrier mechanism*.

**FTP** File Transfer Protocol. The name of the Internet protocol and the program used to transfer files between hosts.

---

## G

**GEM** Gigabit Ethernet.

**group-wide** Across a failover group.

---

## H

**head** Colloquial term for a screen, or display, or monitor, especially in a context where more than one is used in conjunction with the same keyboard and mouse, as in "multihead" feature.

- hotdesking** The ability for a user to remove a smart card, insert it into any other DTU within a server group, and have the user's session "follow" the user, thus allowing the user to have instantaneous access to the user's windowing environment and current applications from multiple DTUs.
- hot key** A pre-defined key that causes something to appear on your screen. A hot key is used to bring up the Settings screen on the Sun Ray DTU.
- hot-pluggable** A property of a hardware component that can be inserted into or removed from a system that is powered on. USB devices connected to Sun Ray DTUs are hot-pluggable.

---

## I

- idle session** A session that is running on a Sun Ray server but to which no user (identified by a smart card token or a pseudo-token) is logged in.
- IKE** Internet Key Exchange, a component of *IPSec*.
- interconnect fabric** All the cabling and switches that connect a Sun Ray server's network interface cards to the Sun Ray DTUs.
- internet** A collection of networks interconnected by a set of routers that enable them to function as a single, large virtual network.
- Internet** The largest internet in the world, consisting of large national backbone nets (such as MILNET, NSFNET, and CREN) and myriad regional and local campus networks all over the world. It is a global collection of networks connecting a wide range of computers using a common protocol to communicate and share services.
- intranet** Any network that provides similar services within an organization to those provided by the Internet but which is not necessarily connected to the Internet.
- IP address** A unique number that identifies each host or other hardware system on a network. An IP address is composed of four integers separated by periods. Each decimal integer must be in the range 0-255 (for example, 129.144.0.0).
- IP address lease** The assignment of an IP address to a computer system for a specified length of time, rather than permanently. IP address leasing is managed by the Dynamic Host Configuration Protocol (DHCP). Sun Ray DTU IP addresses are leased.



**IPSec** Internet Protocol (Security) set of protocols seeks to secure IP communications by encoding data packets through authentication headers (*AH*) and encapsulating security payloads (*ESP*) and by providing a key exchange mechanism (*IKE*).

---

## K

**kiosk mode** Used interchangeably with *CAM* in earlier versions of SRSS. As of version 4.0, this module, now called Kiosk, has been completely rewritten.

---

## L

**LAN** Local area network. A group of computer systems in close proximity that can communicate with one another through some connecting hardware and software.

**layer 2** The data link layer. In the OSI (Open Standards Interconnection) model, there are a total of seven layers. Layer 2 is concerned with procedures and protocols for operating the communication lines between networks as well as clients and servers. Layer 2 also has the ability to detect and correct message errors.

**local host** The CPU or computer on which a software application is running.

**local server** From the client's perspective, the most immediate server in the LAN.

**login** The process of gaining access to a computer system.

**login name** The name by which the computer system knows the user.

---

## M

**MAC address** Media Access Control. A MAC address is a 48-bit number programmed into each local area network interface card (NIC) at the time of manufacture. LAN packets contain destination and source MAC names and can be used by bridges to filter, process, and forward packets. `8:0:20:9e:51:cf` is an example of a MAC address. See also Ethernet address.

- managed object** An object monitored by the Sun Management Center software.
- mobile token** If mobile sessions are enabled, a user can log into an existing session from different locations without a smart card, in which case the user name is associated with the session. This type of *pseudo-token* is called a mobile token.
- mobility** For the purposes of the Sun Ray Server Software, the property of a session that allows it to follow a user from one DTU to another within a server group. On the Sun Ray system, mobility requires the use of a smart card or other identifying mechanism.
- modules** Authentication modules are used to implement various site-selectable authentication policies.
- MTU** Maximum Transmission Unit, used to specify the number of bytes in the largest packet a network can transmit.
- multicasting** The process of enabling communication between Sun Ray servers over their Sun Ray network interfaces in a failover environment.
- multihead** See *head*.
- multiplexing** The process of transmitting multiple channels across one communications circuit.

---

## N

- namespace** A set of names in which a specified ID must be unique.
- network** Technically, the hardware connecting various computer systems enabling them to communicate. Informally, the systems so connected.
- network address** The IP address used to specify a network.
- network address translation** NAT. Network address translation typically involves the mapping of port numbers to allow multiple machines (Sun Ray DTUs in this case) to share a single IP address.
- network interface** An access point to a computer system on a network. Each interface is associated with a physical device. However, a physical device can have multiple network interfaces.
- network interface card** NIC. The hardware that links a workstation or server to a network device.

- network latency** The time delay associated with moving information through a network. Interactive applications such as voice, video displays and multimedia applications are sensitive to these delays.
- network mask** A number used by software to separate the local subnet address from the rest of a given Internet protocol address. An example of a network mask for a class C network is 255.255.255.0.
- network protocol stack** A network suite of protocols, organized in a hierarchy of layers called a stack. TCP/IP is an example of a Sun Ray protocol stack.
- NIC** Network interface card.
- non-smart card mobility** A mobile session on a Sun Ray DTU that does not rely on a smart card. NSCM requires a policy that allows *pseudo-tokens*.
- NSCM** See *non-smart card mobility*.

---

## O

- OSD** On-screen display. The Sun Ray DTU uses OSD icons to alert the user of potential start-up or connectivity problems.

---

## P

- PAM** Pluggable Authentication Module. A set of dynamically loadable objects that gives system administrators the flexibility of choosing among available user authentication services.
- PAM session** A single PAM handle and run time state associated with all PAM items, data, etc.
- patch** A collection of files and directories that replace or update existing files and directories that prevent proper execution of the software on a computer system. The patch software is derived from a specified package format and can only be installed if the package it fixes is already present.
- policy** See *authentication policy*.

- Pop-up GUI** A mechanism that allows the entry of configuration parameters for a Sun Ray DTU from the attached keyboard.
- port** (1) A location for passing data in and out of a computer system. (2) The abstraction used by Internet transport protocols to distinguish among multiple simultaneous connections to a single destination host.
- power cycling** Using the power cord to restart a DTU.
- pseudo-session** A Sun Ray session associated with a *pseudo-token* rather than a smart card token.
- pseudo-token** A user accessing a Sun Ray session without a smart card is identified by the DTU's built-in type and MAC address, known as a pseudo-token. See *token*.
- 

## R

- regional hotdesking** Originally known as Automatic Multigroup Hotdesking (AMGH), this SRSS feature allows users to access their sessions across wider domains and greater physical distances than was possible in earlier versions of SRSS. Administrators enable this feature by defining how user sessions are mapped to an expanded list of servers in multiple failover groups.
- restart** Sun Ray services can be restarted either from the `utrestart` command or with the Warm Restart or Cold Restart buttons on the GUI. A cold restart terminates all Sun Ray sessions; a warm restart does not.
- 

## S

- screen flipping** The ability to pan to individual screens on a DTU with a single head that were originally created by a multihead group.
- server** A computer system that supplies computing services or resources to one or more clients.
- service** For the purposes of the Sun Ray Server Software, any application that can directly connect to the Sun Ray DTU. It can include audio, video, X servers, access to other machines, and device control of the DTU.
- session** A group of services associated with an authentication token. A session may be associated with a token embedded on a smart card

- session mobility** The ability for a session to “follow” a user’s login ID or a token embedded on a smart card.
- smart card** Generically, a plastic card containing a microprocessor capable of making calculations. Smart cards that can be used to initiate or connect to Sun Ray sessions contain identifiers, such as the card type and ID. Smart card tokens may also be registered in the Sun Ray Data Store, either by the Sun Ray administrator or, if the administrator chooses, by the user.
- smart card token** An authentication token contained on a smart card. See *token*.
- spanning tree** The spanning tree protocol is an intelligent algorithm that allows bridges to map a redundant topology and eliminates packet looping in Local Area Networks (LAN).
- store-and-forward switches** The switch reads and stores the entire incoming frame in a buffer, checks it for errors, reads and looks up the MAC addresses, and then forwards the complete good frame out onto the outbound port.
- subnet** A working scheme that divides a single logical network into smaller physical networks to simplify routing.

---

## T

- TCP/IP** Transmission Control Protocol/Internet Protocol (TCP/IP) is a networking protocol that provides communication across interconnected networks, between computers with diverse hardware architectures and operating systems.
- thin client** Thin clients remotely access some resources of a computer server, such as compute power and large memory capacity. The Sun Ray DTUs rely on the server for all computing power and storage.
- timeout value** The maximum allowed time interval between communications from a DTU to the Authentication Manager.
- token** The Sun Ray system requires each user to present a token, which the Authentication Manager uses to allow or deny access to the system and to sessions. A token consists of a type and an ID. If the user uses a smart card, the smart card’s type and ID are used as the token. If the user is not using a smart card, the DTU’s built-in type and ID (the unit’s Ethernet, or MAC, address) are used instead as a *pseudo-token*. If mobile sessions are enabled, a user can log into an existing session from different locations without a smart card, in which case the user name is associated with the session. A pseudo-token used for mobile sessions is called a *mobile token*.

---

## U

- URL** Uniform Resource Locator. A standard for writing a textual reference to an arbitrary piece of data in the World Wide Web (WWW). The syntax of a URL is `protocol://host/localinfo` where `protocol` specifies a protocol to use to fetch the object (such as HTTP or FTP), `host` specifies the Internet name of the host on which to find it, and `localinfo` is a string (often a file name) passed to the protocol handler on the remote host.
- USB** Universal Serial Bus.
- user name** The name a computer system uses to identify a particular user. Under UNIX, this is a text string of up to eight characters composed of letters (a-z and A-Z), digits (0-9), hyphens (-), and underscores (\_), for example, *jpmorgan*, *jp\_morg*, *jpm-888*. The first character must be a letter.
- user session** A session that is running on a Sun Ray server and to which a user (identified by a smart card token or a pseudotoken) is logged in.

---

## V

- virtual frame buffer** A region of memory on the Sun Ray server that contains the current state of a user's display.
- VPN** Virtual Private Network.
- VLAN** Virtual Local Area Network.

---

## W

- warm restart** See [restart](#).
- work group** A collection of associated users who exist in near proximity to one another. A set of Sun Ray DTUs that are connected to a Sun Ray server provides computing services to a work group.

---

# X

**X server** A process which controls a bitmap display device in an X window system. It performs operations on request from client applications.





# Index

---

## Symbols

.parms files, 112

## A

acceptRedirectToken, 70

adapters, 64

admin password, 18

Administration Group

viewing failover group status, 181

Administration Tool, 73

changing the admin password, 53

desktops

displaying current properties, 44

editing a single desktop's properties, 44

examining log files, 38

agent, 124

alarms, 124

Details window, 130

monitoring, 129

setting, 126

Tool Tip window, 131

values, 127

AltAuth, 87, 106

AMGH, 76

appliance

adding to be monitored, 137

deleting to be excluded, 137

hotdesking to a multihead group, 148

multihead feature, 141

multihead group, 142

ARCFOUR, 81

attacks

man-in-the-middle, 82

Attribute Editor, 133

AUDIODEV environment variable, 218

authentication, 81

server, 82

Authentication Manager, 4, 35, 148, 172, 176

configuration file, 177

flowchart for primary appliance, 149, 150

interacting with Session Manager, 6

restarting, 178

AuthPort, 106

AuthSrvr, 5, 87, 106, 203

## B

bandwidth

limited backplane, 10

barrier

firmware, 211

BarrierLevel, 106

bidirectional encryption, 82

BOOTP forwarding, 88

BYTES SENT, 35

## C

C, 28

Cabling

fiber-optic, 11

CDE toolbar, 142, 147

central registration, 5

Cisco IOS Executive, 88

Cisco IOS-based router, 105

- Cisco router, 111
- Citrix, 221
- client
  - authentication, 81
- code
  - DHCP option, 109
- command
  - utadm, 170, 176
  - utcapture
    - data elements, 35
  - utconfig, 141, 179, 185
  - utmhconfig, 142
  - utreplica, 179
  - utswitch, 22
- commands
  - utadm, 28
  - utadm -r, 30
  - utaudio, 218
  - utdetach, 70
  - utfwadm, 31
  - utpolicy, 75
  - utpolicy -i clear, 23
  - utrestart -c, 23
  - utwall, 73, 75
- configuration
  - security, 82, 83
- configuration data
  - DHCP, 28, 73, 169, 173
- console, 124
- crontab, 179
- Ctrl-Moon, 193
- Ctrl-Power, 193
- cursor
  - green newt, 204
  - X, 204

## D

- daemon
  - data store, 32
- daemons
  - Sun Ray Service panel, 134
- Data Store, 179
- data store, 8
  - primary server, 183
  - regional hotdesking
    - to configure, 79

- DHCP
  - state codes, 198
- DHCP State Code, 198
- dedicated interconnect, 90
- departments, 12
- desktopID, 36
- desktops
  - displaying current properties, 44
  - editing a single desktop's properties, 44
- Desktops panel, 136
- device
  - directory, 55
  - links, 57
  - node ownership, 57
  - nodes, 56
  - USB, 56
- DHCP, 170, 202
  - configuring for failover, 172
- DHCP Client Class, 107
- DHCP configuration data, 28, 73, 169, 173
- DHCP option 49, 105
- DHCP options
  - vendor-specific, 106
- DHCP Relay Agent, 88
- DHCP relay agent, 99
- DHCP server, 173
- DHCP servers, 169
- DHCPACK, 109
- DHCPDISCOVER, 88
- DHCPINFORM, 88, 109
- DHCPServer, 203
- dhtadm -R, 28
- directly-connected dedicated interconnect, 93
- directly-connected shared subnet, 90, 95, 96, 98
- DNS, 112
- Domain Name Service, 112
- DSA, 81
- dtlogin, 5, 204
- dtlogin screen, 68
- DTU, 35
- DTU Hardware State, 199
- DTU initialization, 86
- duplicate IP addresses, 28, 73, 169, 173
- Dynamic Host Configuration Protocol (DHCP), 3

## E

- e, 169
- each, 169
- encapsulated options, 108
- encryption
  - algorithm, 81
  - bidirectional, 82
  - downstream only, 82
  - upstream only, 82
- environment variables
  - LD\_PRELOAD, 219
- errors
  - out of memory, 28, 73, 169, 173
- escape tokens, 72
- Ethernet switch, 11

## F

- failover
  - address allocation formula, 170
  - configuring DHCP, 172
  - group, 123, 167
    - primary server, 179
    - removing replication configuration, 181
    - secondary server, 180
  - Group Manager module, 169
  - principle components needed, 169
  - server IP addresses, 171
  - setting up group, 179
  - taking servers offline, 186
- failover group, 13
  - administration status, 181
  - recovery procedures, 183
  - viewing status, 181
- failover groups, 168
- firmware download, 210
- firmware module, 3
  - PROM version management, 31
- FWSrvr, 106, 107, 109

## G

- GDM, 5
- gmSignature, 185
- green newt cursor, 203, 204
- green newt icon, 204
- Group Manager
  - keepalive message, 177

- load balancing, 2, 178
- redirection, 20, 177
  - using Authentication Manager properties, 177
- Group manager, 176
- group manager
  - keepalive message, 176
- group manager module, 176
- group signature, 17
  - setting up, 185
- GXcopy, 223

## H

- hacking
  - man-in-the-middle attacks, 82
- hard security mode, 82
- hexadecimal values, 109
- Hot Desking, 67
- hot key, 190
  - changing setting, 192
  - changing setting site-wide, 191
  - detaching a mobile session, 70
  - entry, 190
  - values, 191
- Hotdesking, 57
- hotdesking, 67, 148, 218
  - regional, 76
- hotkey key combination, 71

## I

- Icon Codes, 196
- icon messages
  - OSD, 196
- IEEE802.MACID directory, 55
- ifname, 93
- INFORMServer, 203
- Interconnect, 11
- interconnect, 11
  - boost power of, 11
  - dedicated, 90
  - implementing a Sun Ray, 10
- interconnect fabric, 9
  - adding an interface, 28
  - deleting an interface, 29
  - departments, 12
  - failover group, 13
  - managing, 28

- printing configuration, 29
- removing an interface, 30
- interconnect IP address, 28, 73, 169, 173
- Interconnect panel, 135
- Internal database, 179
- Intf, 106
- IOS, 105
- IP address
  - duplicate, 28, 73, 169, 173

## K

- keepalive message, 176, 177
- key combination, 71

## L

- LAN, 1
- LATENCY, 35
- layer 2 switch, 11
- LD\_PRELOAD environment variable, 219
- LDIF, 183
- LED signals, 199
- libusb, 64
- load balancing, 2, 178
  - turning off, 178
- log files
  - examining, 38
- LogAppl, 106, 107
- LogHost, 106, 107
- login screen, 5
- LogKern, 106, 107
- LogNet, 106, 107
- LogUSB, 106, 107
- LogVid, 106, 107
- low-bandwidth deployment, 1, 107

## M

- managed object, 123
  - desktops, 136
  - Interconnect panel, 135
  - monitoring, 132
  - Sun Ray system, 132
- man-in-the-middle attack, 82
- mass storage, 187
- Maximum Transfer Unit (MTU), 111

- message\_class, 215
- modules, 4
  - Registered, 5
  - StartSession, 5
- monitoring programs
  - CA Unicenter, 138
  - HP OpenView VPO, 138
  - Tivoli TMS, 138
- mount point
  - stale, 218
- MTU, 111
- multihead, 220
  - administration tool, 144
  - creating a new group, 145
  - group, 142, 149
  - hotdesking to an appliance, 148
  - screen display, 144
  - turning on policy from command line, 144
  - turning on policy with administration tool, 144
- multihead feature, 141

## N

- Netscape, 221
- network
  - adding an interface, 28
  - deleting an interface, 29
  - removing an interface, 30
- NewTBW, 106
- NewTDispIndx, 106
- NewTFlags, 106
- NewTVer, 106, 107
- non-secure session, 82
- NSC mobile session, 67, 75
- NSC mobile session login, 68
- NSCM session, 68
  - enabling from Administration Tool, 73
  - enabling from command line, 75
  - logging in to, 69

## O

- openGL, 221
- option 49, 87, 105
- option code, 109
- options
  - encapsulated, 108
- OSD

- icon messages, 196
- understanding, 195
- out of memory error, 28, 73, 169, 173

## P

- packet loss
  - utcapture, 35
- packets, 108
  - out-of-order, 108
- PAM
  - stack, 77
- panel
  - Desktops, 136
  - Interconnect, 135
  - Sun Ray System, 133
- panning, 143
- parallel peripherals, 55
- PDA synchronization, 63
- PDASync, 219
- PERCENT LOSS, 35
- peripherals, 187
  - parallel, 55
  - serial, 55
- persistent settings (monitor), 18
- policies, 4
  - removing old, 23
- POST, 3
- power cycle, 193
- Power LED, 199
- power-on self test (POST)
  - firmware module, 3
- Primary server, 179
- printer
  - printing to attached, 61
- printers
  - non-PostScript, 63
  - setting up, 61
- printing, 58
- PROM, 31
- ps, 7
- pseudo-token, 72

## Q

- QuickLogin, 68

## R

- rdate, 179
- redirection
  - Group Manager, 20, 177
- redundant failover group, 170
- regional hotdesking, 76
- Registered module, 5
- Relay Agent
  - DHCP, 88
- remote shared subnet, 90
- remote subnet, 99
- Remove replication, 181
- restart, 144

## S

- screen flipping, 148
- Secondary server, 179
- secure session, 82
- security
  - configuration, 82, 83
  - interconnect, 81
  - session, 83
- security mode
  - hard, 82
  - soft, 82
- security status, 84
- selectAtLogin, 21
- self-registration, 5, 75
- serial peripherals, 55
- server
  - authentication, 81, 82
- Server addresses, 171
- Server-to-switch bandwidth, 11
- service, 6
- session, 6
  - changes, 7
  - secure vs non-secure, 82
- session change, 58
- Session Manager, 2, 6
- settings
  - monitor
    - persistent, 18
- shared memory, 221
- Short Cut, 71
- simple failover group, 168

- Simple Network Management Protocol, 124
- SNMP, 124
- soft security mode, 82
- spoofing, 82
- SRDS, 8
- StarOffice, 221
- StartSession module, 5
- state codes
  - DHCP, 198
- status
  - security, 84
- storage
  - devices
    - supported, 187
  - USB
    - mass, 187
- subnet
  - directly-connected
    - shared, 95, 96, 98
  - remote
    - deployment on, 99
- Sun Data Store, 17
- Sun Management Center (Sun MC), 123
- Sun MC
  - additional modules, 125
  - components, 124
  - creating an object, 126
  - notifying when parameter reached, 124
  - setting up monitoring environment, 125
- Sun Ray
  - Data Store, 179
- Sun Ray administration data
  - changing, 53
- Sun Ray appliance, 1, 2
  - firmware module, 3
  - multihead feature, 141
  - multihead group, 142
  - shield users, 11
  - starting a print queue, 61
- Sun Ray daemons, 134
- Sun Ray data store daemon, 32
- Sun Ray DTU
  - updating and upgrading, 31
- Sun Ray DTU (appliance), 35
- Sun Ray interconnect
  - server IP addresses, 171
- Sun Ray module
  - activating for troubleshooting, 226
  - loading, 224
  - troubleshooting, 224
- Sun Ray node
  - creating, 123
- Sun Ray server, 1, 35
  - device directory, 55
  - monitoring with CA Unicenter, 138
  - monitoring with HP OpenView VPO, 138
  - monitoring with Tivoli TMS, 138
  - network interfaces, 12
  - software, 4
  - software daemons, 124
- Sun Ray services, 123
- Sun Ray Services panel
  - daemons, 134
- Sun Ray Settings
  - changing, 188
- Sun Ray system, 123
  - computing model, 1
  - monitoring feature, 124
- Sun Ray System panel
  - displaying, 132
  - refreshing, 133
  - setting alarms, 133
- SunMC, 123
  - Health Monitor module, 125
  - Process Monitoring, 125
- SUNW.NewT.SUNW, 106, 107
- SUNWlibusb, 65
- SUNWlibusbbut, 65
- SUNWsynom, 125
- SUNWutesa package
  - removing, 140
- Switch
  - high-capacity, 11
  - low-capacity, 11
- switch
  - basic types of 100 Mbps, 11
  - layer 2, 11
- syslog, 211

**T**

- Tarantella, 221
- TCP, 172

- TerminalGroup policy, 148
- TERMINALID, 35
- TFTP, 109
- thread\_name, 215
- TIMESTAMP, 35
- TOTAL LOSS, 35
- TOTAL PACKET, 35
- troubleshooting
  - activating the Sun Ray module, 226
  - loading the Sun Ray module, 224

## U

- Uplink ports, 11
- utaction, 16
- utadm, 16, 28
- utadm -A, 98
- utadm command, 28, 170
  - available options, 176
- utadm -L, 99
- utadm -r command, 30
- utadminuser, 16
- utamghadm, 78, 80
- utaudio command, 218
- utauthd, 217
- utcapture, 16, 110
- utcapture command
  - data elements, 35
- utcard, 16, 32
- utconfig, 16
- utconfig command, 141, 179, 185
- utcrypto, 16, 82
- utdesktop, 16
- utdetach, 16, 191
- utdetach command, 70
- utdevadm, 26
- utdiskadm, 17
- utdsd daemon, 32
- utdssync, 17
- uteject, 17
- utfwadm, 17
- utfwadm command, 31
- utfwload, 17
- utfwsync, 17
- utgroupsig, 17, 186

- utgstatus, 17
- utidle, 217
- utinstall, 17
- utkiosk, 17
- utload, 217
- utmhadm, 17, 141
- utmhconfig, 17, 141
- utmhconfig command, 142
- utmount, 17
- utpolicy, 18
- utpolicy command, 75
- utpolicy -i clear command, 23
- utpreserve, 18
- utpw, 18
- utquery, 18, 110, 202, 203
- utreader, 18
- utreplica, 18, 179
- utreplica command, 179
- utresadm, 18, 189
- utresdef, 18
- utrestart, 18, 144
- utrestart -c, 23
- utselect, 18, 20, 58, 177
- utsession, 18
- utsessiond, 7, 215
- utset, 18
- utsettings, 18, 189, 191, 192
- utslaunch.properties files, 71
- utsunmc, 18, 140
- utsunmcinstall, 19, 140
- utswitch, 19, 20, 58
- utswitch command, 22
- utumount, 19
- utuser, 19
- utwall, 19
- utwall command, 73, 75
- utwho, 19
- utxconfig, 19

## V

- v, 17
- vendor-specific DHCP ptions, 106
- vendor-specific options, 107

virtual frame buffer, 3

VLAN, 12

    implementing a Sun Ray interconnect, 10

    multiple configuration, 10

## **W**

WAN, 1, 108

## **X**

X cursor, 204

X Window Display Manager, 87, 105, 107

Xconfig, 204

XINERAMA, 142, 147

Xinerama, 220

Xservers, 204

Xsun, 204