



Sun Ray™ Server Software 3 Administrator's Guide

for the Solaris™ Operating System

Sun Microsystems, Inc.
www.sun.com

Part No. 817-6806-10
November 2004, Release A

Submit comments about this document at: <http://www.sun.com/hwdocs/feedback>

Copyright 2002, 2003, 2004, Sun Microsystems, Inc., 4150 Network Circle, Santa Clara, California 95054, U.S.A. All rights reserved.

Sun Microsystems, Inc. has intellectual property rights relating to technology embodied in the product that is described in this document. In particular, and without limitation, these intellectual property rights may include one or more of the U.S. patents listed at <http://www.sun.com/patents>, and one or more additional patents or pending patent applications in the U.S. and in other countries.

This document and the product to which it pertains are distributed under licenses restricting their use, copying, distribution, and decompilation. No part of the product or of this document may be reproduced in any form by any means without prior written authorization of Sun and its licensors, if any.

Third-party software, including font technology, is copyrighted and licensed from Sun suppliers.

Parts of the product may be derived from Berkeley BSD systems, licensed from the University of California. UNIX is a registered trademark in the U.S. and other countries, exclusively licensed through X/Open Company, Ltd.

Sun, Sun Microsystems, the Sun logo, Sun Ray, Sun WebServer, Sun Enterprise, Ultra, UltraSPARC, SunFastEthernet, Sun Quad FastEthernet, Java, JDK, HotJava, and Solaris are trademarks, registered trademarks, or service marks of Sun Microsystems, Inc. in the U.S. and other countries. All SPARC trademarks are used under license and are trademarks or registered trademarks of SPARC International, Inc. in the U.S. and other countries. Products bearing SPARC trademarks are based upon an architecture developed by Sun Microsystems, Inc.

Netscape is a trademark or registered trademark of Netscape Communications Corporation.

The OPEN LOOK and Sun™ Graphical User Interface was developed by Sun Microsystems, Inc. for its users and licensees. Sun acknowledges the pioneering efforts of Xerox in researching and developing the concept of visual or graphical user interfaces for the computer industry. Sun holds a non-exclusive license from Xerox to the Xerox Graphical User Interface, which license also covers Sun's licensees who implement OPEN LOOK GUIs and otherwise comply with Sun's written license agreements.

Federal Acquisitions: Commercial Software—Government Users Subject to Standard License Terms and Conditions.

Use, duplication, or disclosure by the U.S. Government is subject to restrictions set forth in the Sun Microsystems, Inc. license agreements and as provided in DFARS 227.7202-1(a) and 227.7202-3(a) (1995), DFARS 252.227-7013(c)(1)(ii) (Oct. 1998), FAR 12.212(a) (1995), FAR 52.227-19, or FAR 52.227-14 (ALT III), as applicable.

DOCUMENTATION IS PROVIDED "AS IS" AND ALL EXPRESS OR IMPLIED CONDITIONS, REPRESENTATIONS AND WARRANTIES, INCLUDING ANY IMPLIED WARRANTY OF MERCHANTABILITY, FITNESS FOR A PARTICULAR PURPOSE OR NON-INFRINGEMENT, ARE DISCLAIMED, EXCEPT TO THE EXTENT THAT SUCH DISCLAIMERS ARE HELD TO BE LEGALLY INVALID.

Copyright 2002, 2003, 2004, Sun Microsystems, Inc., 4150 Network Circle, Santa Clara, California 95054, Etats-Unis. Tous droits réservés.

Sun Microsystems, Inc. a les droits de propriété intellectuelle relatant à la technologie incorporée dans le produit qui est décrit dans ce document. En particulier, et sans la limitation, ces droits de propriété intellectuelle peuvent inclure un ou plus des brevets américains énumérés à <http://www.sun.com/patents> et un ou les brevets plus supplémentaires ou les applications de brevet en attente dans les Etats-Unis et dans les autres pays.

Ce produit ou document est protégé par un copyright et distribué avec des licences qui en restreignent l'utilisation, la copie, la distribution, et la décompilation. Aucune partie de ce produit ou document ne peut être reproduite sous aucune forme, par quelque moyen que ce soit, sans l'autorisation préalable et écrite de Sun et de ses bailleurs de licence, s'il y en a.

Le logiciel détenu par des tiers, et qui comprend la technologie relative aux polices de caractères, est protégé par un copyright et licencié par des fournisseurs de Sun.

Des parties de ce produit pourront être dérivées des systèmes Berkeley BSD licenciés par l'Université de Californie. UNIX est une marque déposée aux Etats-Unis et dans d'autres pays et licenciée exclusivement par X/Open Company, Ltd.

Sun, Sun Microsystems, le logo Sun, Sun Ray, Sun WebServer, Sun Enterprise, Ultra, UltraSPARC, SunFastEthernet, Sun Quad FastEthernet, Java, JDK, HotJava, et Solaris sont des marques de fabrique ou des marques déposées, ou marques de service, de Sun Microsystems, Inc. aux Etats-Unis et dans d'autres pays.

Toutes les marques SPARC sont utilisées sous licence et sont des marques de fabrique ou des marques déposées de SPARC International, Inc. aux Etats-Unis et dans d'autres pays. Les produits portant les marques SPARC sont basés sur une architecture développée par Sun Microsystems, Inc.

Netscape est une marque de Netscape Communications Corporation aux Etats-Unis et dans d'autres pays.

L'interface d'utilisation graphique OPEN LOOK et Sun™ a été développée par Sun Microsystems, Inc. pour ses utilisateurs et licenciés. Sun reconnaît les efforts de pionniers de Xerox pour la recherche et le développement du concept des interfaces d'utilisation visuelle ou graphique pour l'industrie de l'informatique. Sun détient une licence non exclusive de Xerox sur l'interface d'utilisation graphique Xerox, cette licence couvrant également les licenciés de Sun qui mettent en place l'interface d'utilisation graphique OPEN LOOK et qui en outre se conforment aux licences écrites de Sun.

LA DOCUMENTATION EST FOURNIE "EN L'ETAT" ET TOUTES AUTRES CONDITIONS, DECLARATIONS ET GARANTIES EXPRESSES OU TACITES SONT FORMELLEMENT EXCLUES, DANS LA MESURE AUTORISEE PAR LA LOI APPLICABLE, Y COMPRIS NOTAMMENT TOUTE GARANTIE IMPLICITE RELATIVE A LA QUALITE MARCHANDE, A L'APTITUDE A UNE UTILISATION PARTICULIERE OU A L'ABSENCE DE CONTREFAÇON.

Contents

Preface **xxiii**

1. Sun Ray System Overview **1**

 Computing Model 1

 The Sun Ray System 2

 Sun Ray DTU 2

 Multihead Displays 3

 Firmware Module 3

 Sun Ray Server Software 4

 Authentication Manager 4

 Sessions and Services 6

 Session Manager 6

 Sun Management Center 8

 CLI and Admin GUI 8

 Data Store 8

 Controlled Access (Kiosk) Mode 8

 Network Components 9

 Sun Ray Interconnect Fabric 9

 VLAN Implementation 10

 LAN Implementation 11

Physical Connections	11
Deployment Examples	12
Small Deployments	12
Medium to Large Deployments	12
Failover Group Scenario	13
Security Considerations	14
2. Command-Line Interface	15
Supported Commands	15
▼ To Stop Sun Ray Services	19
▼ To Start Sun Ray Services	19
Session Redirection	19
▼ To Redirect to a Different Server	19
▼ To Redirect a DTU Manually	20
▼ To List Available Hosts	21
▼ To Select a Server with the Latest Session	21
Changing Policies	21
Enabling and Disabling USB Devices	22
▼ To Enable All USB Devices	22
▼ To Disable All USB Device Access	23
▼ To Perform a Cold Restart	23
▼ To Determine the Current State of Devices	23
Configuring Interfaces on the Sun Ray Interconnect Fabric	23
▼ To Add an Interface	24
▼ To Delete an Interface	24
▼ To Print the Sun Ray Private Interconnect Configuration	25
▼ To Add a LAN Subnet	25
▼ To Delete a LAN Subnet	25
▼ To Print Public LAN Subnets	25

- ▼ To Remove All Interfaces and Subnets 25
- Managing Firmware Versions 26
 - ▼ To Update All the DTUs on an Interface 26
 - ▼ To Update a DTU Using the Ethernet (MAC) Address 27
- Restarting the Sun Ray Data Store 27
 - ▼ To Restart Sun Ray Data Store 27
- Smart Card Configuration Files 28
 - ▼ To Load a Configuration File Into the Directory 28
- Configuring and Using Token Readers 28
 - ▼ To Configure a Token Reader 29
 - ▼ To Get a Token ID From a Token Reader 30
- Using the utcapture Tool 30
 - ▼ To Start utcapture 31
- 3. Administration Tool 33**
 - Administration Data 34
 - Logging In 34
 - ▼ To Log Into the Administration Tool 34
 - ▼ To Change the Administrator's Password 36
 - Changing Policies 37
 - ▼ To Change the Policy 38
 - Restarting Sun Ray Services 39
 - ▼ To Preserve Sessions Upon Restart 39
 - ▼ To Terminate Sessions Upon Restart 40
 - Token Readers 40
 - Creating a Token Reader 40
 - ▼ To Create a Token Reader 40
 - ▼ To Locate Token Readers 44
 - ▼ To Get Information on a Token Reader 45

Managing Desktops	45
▼ To List All Desktops	45
▼ To Display a Desktop's Current Properties	46
▼ To List Currently Connected Desktops	46
▼ To View the Properties of the Current User	47
▼ To Search for Desktops	48
▼ To Edit a Single Desktop's Properties	49
Sun Ray DTU Settings	50
▼ To Change the Sun Ray Settings	50
Managing Multihead Groups	51
▼ To View All Multihead Groups	51
Managing USB Services	54
▼ To Enable or Disable USB Device Access	54
Examining Log Files	55
▼ To View a Log File	56
Managing Smart Cards	56
▼ To View or List Configured Smart Cards	57
▼ To View The Smart Card Probe Order	59
▼ To Change the Smart Card Probe Order	59
▼ To Add a Smart Card	60
▼ To Delete a Smart Card	60
Sun Ray System Status	61
▼ To View the Sun Ray System Status	61
Administering Users	62
▼ To View Users by ID	63
▼ To View Users by Name	64
▼ To Delete a User	65
▼ To View Current Users	67

- ▼ To Display a User's Current Properties 67
- ▼ To Add a User 68
- ▼ To View the User's Sessions 69
- ▼ To Edit a User's Properties 70
- ▼ To Add a Token ID to a User's Properties 70
- ▼ To Delete a Token ID From a User's Properties 71
- ▼ To Enable or Disable a User's Token 71
- ▼ To Find a User 72
- ▼ To Get a Token ID From a Token Reader 73

Controlled Access Mode 74

- ▼ To Configure Controlled Access Mode 74
- ▼ To Select Additional Applications 75
- ▼ To Add or Edit Applications 76

Managing Sessions 77

- ▼ To Find Sun Ray Sessions 78
- ▼ To View Sun Ray Sessions 80

4. Peripherals for Sun Ray DTUs 81

Device Nodes and USB Peripherals 81

- Device Nodes 82
- Device Links 83
- Device Node Ownership 83
- Hot Desking and Device Node Ownership 83

Mass Storage Devices 84

- Device Nodes and Links 84
- Mount Points 85
- Device Ownership and Hot Desking 85
- Mass Storage Devices and NSCM 85
- Common Disk Operations 85

Attached Printers 86

Printer Setup 87

▼ To Set Up a Printer 87

Printers Other Than PostScript Printers 89

PDA Synchronization 89

PDASync for Solaris Application on Sun Ray DTUs 89

▼ To Set Up the PDASync Application on a Sun Ray DTU 89

Adapters 90

libusb 90

5. Mobile Sessions (Hot Desking) 93

NSCM Session 93

Sun Ray Mobile Session Login Dialog Box 94

Token Reader Icon 94

▼ To Log In to an NSCM Session 95

Disconnecting an Active NSCM Session 96

Hot Key 96

▼ To Disconnect the Current Session via utdetach 96

▼ To Terminate the Current Session 97

▼ To Reconfigure the Disconnect Hot Key Combination 97

▼ To Customize the Short Cut for Disconnecting an NSCM Session 97

NSCM and Failover Groups 98

Load Balancing Between Servers 98

Switching Between Servers 98

Escape Token Sessions 98

Configuring the Authentication Manager for NSCM Sessions 99

▼ To Enable NSCM Sessions From the Administration Tool 99

▼ To Enable NSCM Sessions From a Command Line 101

6. Encryption and Authentication	103
Introduction	103
Security Configuration	104
Security Mode	104
Session Security	105
Security Status	106
Session Connection Failures	107
7. Deployment on Shared Networks	109
Sun Ray DTU Initialization Requirements	109
DHCP Basics	110
DHCP Parameter Discovery	111
DHCP Relay Agent	112
Network Topology Options	112
Directly-Connected Dedicated Interconnect	114
Directly-Connected Shared Subnet	114
Remote Shared Subnet	114
Network Configuration Tasks	115
Preparing for Deployment	115
Deployment on a Directly-Connected Dedicated Interconnect	116
Directly-Connected Dedicated Interconnect: Example	117
Deployment on a Directly-Connected Shared Subnet	119
Directly-Connected Shared Subnet: Example 1	120
Directly-Connected Shared Subnet: Example 2	122
Deployment on a Remote Subnet	123
Remote Shared Subnet: Example 1	125
Remote Shared Subnet: Example 2	128
Network Performance Requirements	132
Packet Loss	132

Latency	132
Out-of-Order Packets	133
Troubleshooting Tools	133
utcapture	133
utquery	133
OSD Icons	133
8. Monitoring the Sun Ray System	135
Sun Management Center (SunMC) Software Features	135
Additional Sun Management Center Modules	137
Setting Up the Monitoring Environment	137
▼ To Set Up the Monitoring Environment	137
▼ To Create an Object	138
Setting Alarms	138
▼ To Set an Alarm	138
▼ To Start Monitoring	141
Setting Monitoring Guidelines	144
Sun Ray System Panel	144
▼ To Display the Sun Ray System Panel	144
▼ To Refresh the Sun Ray System Panel	145
▼ To Set Alarms	145
Sun Ray Services Panel	146
Failover Group Panel	147
Interconnect Panel	147
▼ To Set an Alarm for Running Out of Addresses	148
Desktops Panel	148
▼ To Add a DTU to Be Monitored	149
▼ To Delete a DTU to Exclude Monitoring	149
Using Other Monitoring Programs	150

Removing the Sun Ray Module from SunMC	152
▼ To Remove the Sun Ray module	152
9. Multihead Administration	153
Multihead Groups	154
Multihead Screen Display	154
Display Resolution	155
Multihead Administration Tool	155
▼ To Turn On Multihead Policy From the Command Line	156
▼ To Turn On Multihead Policy Using the Administration Tool	156
▼ To Create a New Multihead Group	156
XINERAMA	159
Session Groups	160
Authentication Manager	160
10. Controlled Access Mode	163
Controlled Access Mode Functionality	163
Enabling Controlled Access Mode	163
▼ To Enable Controlled Access Mode with the Admin GUI	164
▼ To Configure CAM Settings	165
▼ To Configure CAM Using the CLI	166
Building the Controlled Access Mode Environment	166
▼ To Add a New Application	167
▼ To Edit an Available Application	168
▼ To Make an Application Available to Users	169
▼ To Make an Application Not Available to Users	169
▼ To Remove an Application	170
Advanced Application Setup	171
Enabling Prototypes	171

- ▼ To Enable Prototypes 171
- Using Wrapper Scripts to Customize Controlled Access Mode Applications 172
 - ▼ To Launch an Application Using a Wrapper Script 172
- Modifying CAM User Displays 172
 - ▼ To Change the Backdrop 173
 - ▼ To Change the CDE Menu 173
 - ▼ To Activate Debugging 173
- Security and the Controlled Access Mode Environment 174
 - Failover 174
 - Localization 175
 - ▼ To Change the Locale for Controlled Access Mode Sessions Without Changing the System Locale 175
- 11. Failover Groups 177**
 - Failover Group Overview 178
 - Setting Up IP Addressing 180
 - Setting Up Server and Client Addresses 180
 - Server Addresses 181
 - Configuring DHCP 182
 - Coexistence of the Sun Ray Server With Other DHCP Servers 182
 - Administering Other Clients 183
 - ▼ To Set Up IP Addressing on Multiple Servers Each With One Sun Ray Interface 183
 - Group Manager 186
 - Redirection 187
 - Group Manager Configuration 187
 - ▼ To Restart the Authentication Manager 187
 - Load Balancing 188
 - ▼ To Turn Off the Load Balancing Feature 188

Setting Up a Failover Group	188
Primary Server	189
▼ To Specify a Primary Server	189
Secondary Server	189
▼ To Specify Each Secondary Server	189
▼ To Add Additional Secondary Servers	190
Removing Replication Configuration	190
▼ To Remove the Replication Configuration	190
Viewing the Administration Status	190
▼ To Show Current Administration Configuration	190
Viewing Failover Group Status	191
▼ To View Failover Group Status	191
Sun Ray Failover Group Status Icons	192
Recovery Issues and Procedures	192
Primary Server Recovery	193
▼ To Rebuild the Primary Server Administration Data Store	193
▼ To Replace the Primary Server with a Secondary Server	194
Secondary Server Recovery	195
Setting Up a Group Signature	195
▼ To Change the Group Manager Signature File	195
Taking Servers Offline	196
▼ To Take a Server Offline	196
▼ To Bring a Server Online	196
A. User Settings and Concerns	197
Supported Devices and Libraries	197
Supported Mass Storage Devices	197
Managing Monitor Settings	198
Configuring Hot Key Preferences	198

Setting Hot Key Values 200

- ▼ To Change the Hot Key for the Settings GUI 200
- ▼ To Change the Hot Key Used to Detach NSCM Sessions 201
- ▼ To Change the Hot Key Setting for a Single User 201

Power Cycling a Sun Ray DTU 202

- ▼ To Power Cycle a Sun Ray DTU 202
- ▼ To Perform a Soft Reset 202
- ▼ To Kill a User's Session 202

B. Troubleshooting and Tuning Tips 203

Understanding OSD 203

OSD Icon Topography 203

Sun Ray Desktop Unit Startup 206

- ▼ Actions to take if this icon stays on for more than 10 seconds: 206
- ▼ Actions to take if this icon stays on for more than 10 seconds: 206
- ▼ Actions to take if the icon displays for more than a few seconds or if the DTU continues to reset after the icon is displayed: 208
- ▼ To Identify a Hung Session 208
- ▼ To Kill a Hung Session 208

Firmware Download 209

Firmware Download Failed 210

Bus Busy 210

No Ethernet 211

Ethernet Address 211

Session Connection Failures 212

Token Reader Icon 212

Card Read Error OSD 213

Prompt for Card Insertion OSD 213

Access Denied OSD 213

Wait for Session OSD	214
Wait Icon Cursor for Default Session Type	215
Patches	215
Authentication Manager Errors	215
Troubleshooting USB Mass Storage Devices	218
Device Links Are Not Created	218
Device Is Not Automatically Mounted	218
Device Is Not Automatically Unmounted	218
Audio	219
Audio Device Emulation	219
Audio Malfunction	219
▼ To Activate the Redirection Library	220
PDA Synchronization Issues	220
Performance Tuning	221
General Configuration	221
Applications	221
Sluggish Performance	222
Monitor Display Resolution Defaults to 640 x 480	222
Old Icons (Hourglass with Dashes Underneath) Appear on Display	223
Port Currently Owned by Another Application	223
Design Tips	223
Troubleshooting the Sun Management Center	224
No Sun Ray Object	224
▼ To Load the Sun Ray Module	224
No Sun Ray Module	225
▼ To Activate the Sun Ray Module	226
▼	
▼	

C. Sun Ray and Network Parameter Delivery (DHCP)	227
Encapsulated Options	229
Glossary	231
Index	241

Figures

FIGURE 1-1	Authentication and Session Manager Interaction	6
FIGURE 1-2	Sun Ray System with a Dedicated Interconnect Fabric	9
FIGURE 1-3	Example of Shared Physical Resources in Multiple VLANs Configuration	10
FIGURE 1-4	Small Deployment Scenario	13
FIGURE 1-5	Simple Failover Group	14
FIGURE 2-1	The Server Selection (<code>utselect</code>) GUI	20
FIGURE 2-2	Using a Token Reader to Register Smart Cards	29
FIGURE 3-1	Login Window	35
FIGURE 3-2	Summary Status Window	36
FIGURE 3-3	Change Admin Password Window	37
FIGURE 3-4	Change Policy Window	38
FIGURE 3-5	Sun Ray Services Window	39
FIGURE 3-6	View Current Desktops Window	41
FIGURE 3-7	Current Properties Window	42
FIGURE 3-8	Edit Desktop Properties Window	43
FIGURE 3-9	Token Readers Window	44
FIGURE 3-10	Current Properties of a Token Reader	45
FIGURE 3-11	View All Desktops Window	46
FIGURE 3-12	Find Desktop Window	48
FIGURE 3-13	Find Desktop Search Results Window	49

FIGURE 3-14	Settings Screen	50
FIGURE 3-15	The Multihead Groups Window	51
FIGURE 3-16	The Multihead Group Properties Window	52
FIGURE 3-17	Desktops Current Properties Window	53
FIGURE 3-18	USB Services Window	54
FIGURE 3-19	Administration Log File Window	56
FIGURE 3-20	The View Configured Smart Cards Window	57
FIGURE 3-21	Smart Card Properties Window	58
FIGURE 3-22	Smart Card Probe Order Window	59
FIGURE 3-23	Add Smart Card to Probe List Window	60
FIGURE 3-24	Summary Status Window	61
FIGURE 3-25	View Users by ID Window	63
FIGURE 3-26	View Users by Name Window	64
FIGURE 3-27	The Current Properties Window Shows Administrative Options for a User	65
FIGURE 3-28	Delete User Window	66
FIGURE 3-29	View Current Users Window	67
FIGURE 3-30	Add User Window	68
FIGURE 3-31	Edit User Properties Page	70
FIGURE 3-32	Find User Window	72
FIGURE 3-33	Get Token ID Window	73
FIGURE 3-34	Controlled Access Mode Configuration Window	74
FIGURE 3-35	Select Additional Applications Window	75
FIGURE 3-36	Add/Edit Apps Window	76
FIGURE 3-37	Confirmation Window	77
FIGURE 3-38	The Find Sun Ray Sessions Window	78
FIGURE 3-39	Sun Ray Sessions Window Showing Search Results	79
FIGURE 3-40	Sessions on Current Sun Ray Server Window	80
FIGURE 5-1	Sun Ray Mobile Session Login Dialog Box	94
FIGURE 5-2	User Name Entry	95
FIGURE 5-3	User Password Entry	95

FIGURE 5-4	Change Policy Window	100
FIGURE 5-5	Change Policy Confirmation Window	101
FIGURE 6-1	Sun Ray Security Configuration Window	105
FIGURE 7-1	Network Topologies for Sun Ray DTU Deployment	113
FIGURE 7-2	Sun Ray Network Topology	116
FIGURE 8-1	Sun Management Center Details Window	139
FIGURE 8-2	Example Using the Failover Group Panel	139
FIGURE 8-3	Alarm Window	141
FIGURE 8-4	Details Window With Alarms	142
FIGURE 8-5	Alarm Summary Window	143
FIGURE 8-6	Sun Ray System Panel	144
FIGURE 8-7	Sun Ray Services (daemons) Panel	146
FIGURE 8-8	Failover Group Panel	147
FIGURE 8-9	Interconnect Panel	148
FIGURE 8-10	Desktops Panel	149
FIGURE 8-11	Example of Interoperability (Systems B, C, and E must be Solaris SPARC systems)	151
FIGURE 9-1	The Multihead Screen Display	155
FIGURE 9-2	Multihead Group List With Group Detail	157
FIGURE 9-3	Create New Multiheaded Group Pop-up Dialog Box	157
FIGURE 9-4	Setup Display for the New Multihead Group	158
FIGURE 9-5	Completed Multihead Group List With Active Finish Button	158
FIGURE 9-6	Authentication Manager Flowchart for the Primary DTU	160
FIGURE 9-7	Authentication Manager Flowchart for the Secondary DTU	161
FIGURE 10-1	Change Policy Window	164
FIGURE 10-2	Controlled Access Mode Configuration Panel	165
FIGURE 10-3	Add/Edit Apps Panel	167
FIGURE 10-4	Additional Applications Configuration Panel	169
FIGURE 11-1	Simple Failover Group	178
FIGURE 11-2	Redundant Failover Group	179

FIGURE 11-3	Failover Group Status Table	191
FIGURE B-1	Ethernet Address OSD with Different Encryption and Authentication States	211
FIGURE B-2	Module Panel	225

Tables

TABLE 2-1	Supported Commands	16
TABLE 2-2	<code>utrestart</code> Commands	22
TABLE 2-3	Data Elements Displayed	30
TABLE 2-4	<code>utcapture</code> Options	31
TABLE 3-1	Log Files	55
TABLE 3-2	Key User Fields	62
TABLE 3-3	Login Status Fields	68
TABLE 3-4	Sun Ray Session States	77
TABLE 4-1	Definitions of Naming Conventions	82
TABLE 4-2	Commands for Common Disk Operation	86
TABLE 4-3	Open Source <code>libusb</code> Applications	91
TABLE 7-1	DHCP Service Parameters Available	111
TABLE 7-2	Vendor-specific DHCP Options	130
TABLE 8-1	Three Components of Sun Management Center Software	136
TABLE 8-2	Properties on the Sun Ray System Panel	145
TABLE 8-3	Desktop Information	149
TABLE 11-1	Configuring Five Servers for 100 DTUs	180
TABLE 11-2	Available Options	185
TABLE 11-3	Failover Group Status Icons	192
TABLE A-1	Sun Ray Settings Properties Files	199

TABLE A-2	Specific Hot Key Values	199
TABLE B-1	Icon Messages	204
TABLE B-2	DCHP State Codes	205
TABLE B-3	Power LED	205
TABLE B-4	Error Message Examples	217
TABLE C-1	Sun Ray Parameter Symbol Values (as defined in the DHCP table)	228

Preface

The *Sun Ray Server Software 3 Administrator's Guide for the Solaris™ Operating System* provides instructions for setting up, administering, monitoring, and troubleshooting a system of Sun Ray™ Desktop Units (DTUs) and their server or servers. It is written for system administrators who are already familiar with the Sun Ray™ computing paradigm and have substantial networking knowledge. This guide may also be useful for those interested in customizing Sun Ray systems.

Before You Read This Book

This guide assumes that you have installed the Sun Ray Server Software on your server from the Sun Ray Server Software 3 CD or the Electronic Software Download (ESD) and that you have added the required patches.

How This Book Is Organized

Chapter 1 gives an overview of the Sun Ray system.

Chapter 2 describes the command-line interface.

Chapter 3 describes the Administration Tool.

Chapter 4 describes peripherals for Sun Ray DTUs.

Chapter 5 describes mobile sessions, also known as Hot desking.

Chapter 6 gives a brief description of traffic encryption between Sun Ray clients and servers and server-to-client authentication.

Chapter 7 discusses network requirements, including LAN, VLAN, and dedicated interconnect options, switch requirements, and other network topology issues.

Chapter 8 describes how to monitor the Sun Ray System using Sun Management Center software.

Chapter 9 describes how to implement multihead and XINERAMA on a Sun Ray system.

Chapter 10 describes how to customize Sun Ray Server Software for controlled access mode.

Chapter 11 discusses failover groups.

Appendix A discusses user issues and concerns.

Appendix B provides troubleshooting information, including error messages from the Authentication Manager.

Appendix C contains a listing of Sun Ray parameter symbol values defined in the DHCP table and a brief discussion of encapsulated options.

This manual also contains a glossary and an index.

Using UNIX Commands

This document does not contain information on basic UNIX® commands and procedures, such as shutting down the system, booting the system, or configuring devices. This document does, however, contain information about specific Sun Ray system commands.

Typographic Conventions

Typeface	Meaning	Examples
AaBbCc123	The names of commands, files, and directories; on-screen computer output	Edit your <code>.login</code> file. Use <code>ls -a</code> to list all files. % You have mail.
AaBbCc123	What you type, when contrasted with on-screen computer output	% su Password:
<i>AaBbCc123</i>	Book titles, new words or terms, words to be emphasized	Read Chapter 6 in the <i>User's Guide</i> . These are called <i>class</i> options. You <i>must</i> be superuser to do this.
	Command-line variable; replace with a real name or value	To delete a file, type <code>rm filename</code> .

Shell Prompts

Shell	Prompt
C shell	<i>machine_name</i> %
C shell superuser	<i>machine_name</i> #
Bourne shell and Korn shell	\$
Bourne shell and Korn shell superuser	#

Related Documentation

Application	Title	Part Number
Installation	<i>Sun Ray Server Software 3 Installation and Configuration Guide for the Solaris Operating System</i>	817-6805-10
Release Notes	<i>Sun Ray Server Software 3 Release Notes for the Solaris Operating System</i>	817-6808-10

Accessing Sun Documentation

You can view, print, or purchase a broad selection of Sun documentation, including localized versions, at:

<http://www.sun.com/documentation>

Sun Welcomes Your Comments

Sun is interested in improving its documentation and welcomes your comments and suggestions. You can email your comments to Sun at:

docfeedback@sun.com

Please include the part number (817-6806-10) of your document in the subject line of your email.

Sun Ray System Overview

Although thin client computing has been discussed and attempted for many years, Sun Ray is the first implementation to offer both workstation-like user functionality and sufficient speed and reliability to be suitable for mission-critical applications. The latest generation of Sun Ray Server Software now supports many USB peripheral devices, LAN and low-bandwidth WAN deployment. Originally developed on Sun's Solaris™ Operating System, Sun Ray Server Software is now also supported on three Linux variants: Red Hat Enterprise Linux Advanced Server 3, SuSE Linux Enterprise Server 8, and Sun Java™ Desktop System 2.

Computing Model

The Sun Ray system employs a network-dependent model in which all computing is performed on a server, with input and output data passed back and forth between the Sun Ray server and the Sun Ray Desktop Units (DTUs). Nearly any Sun server with sufficient capacity can be configured as a Sun Ray server so long as it runs a supported version of the Solaris operating system or one of the supported flavors of Linux.

Various models of Sun Ray DTU are available, differing primarily with respect to size and type of screen; however, all Sun Ray DTUs also include a smart card reader, a keyboard, and a mouse. Sun Ray DTUs have no local disks, operating systems, or applications; they are therefore considered *stateless*. This is what makes them true, or "ultra" thin clients, and it is what makes them inexpensive to maintain as well as extremely secure, both from an intellectual property perspective and for government work. Although USB mass storage devices are supported in the latest release, the ability to use them is administered centrally so that sites with security requirements can easily remove the sort of risk imposed by PCs and other fat clients that allow the theft of data in case a physical device is stolen.

Because effective client-server network traffic often relies on the rapid movement of large numbers of packets, an optimal Sun Ray implementation requires a well-designed network. Most large implementations include at least one *failover group* to ensure uninterrupted service whenever a server goes off-line.

Once a failover group is set up, Sun Ray Server Software provides automatic load balancing to optimize performance by spreading the computing load among the servers in the group. If a server is taken out of service, the Group Manager on each remaining server tries to distribute that server's sessions evenly among the remaining servers. The load balancing algorithm takes into account each server's load and capacity (number and speed of its CPUs) so that larger or less heavily loaded servers host more sessions. These concepts are addressed in Chapter 11 and in the *Sun Ray Server Software 3 Installation and Configuration Guide*.

User sessions—groups of services controlled by the Session Manager and associated with a user through an authentication token—reside on a server and are directed to a Sun Ray DTU. Because Sun Ray DTUs are stateless, a user session can be redirected to any Sun Ray DTU on the appropriate network or subnetwork when a user logs in or inserts a smart card.

While the session continues to reside on a server, it appears to follow the user to the new DTU. This functionality, called *session mobility*, is the key architectural feature that enables *hot desking*—the ability of users to access their sessions from any DTU on their network. In early versions of Sun Ray Server Software, mobile sessions were possible only with smart cards. It is now possible to enable hot desking with or without smart cards.

The Sun Ray System

The Sun Ray system consists of Sun Ray DTUs, servers, server software, and the physical networks that connect them.

Sun Ray DTU

The Sun Ray desktop unit (DTU) delivers and may exceed the full functionality of a workstation or a multimedia PC. The key features include:

- 24-bit, 2-D accelerated graphics up to 1920 x 1200 resolution at 72 Hz (640 x 480 at 60 Hz is the lowest resolution)
- Multichannel audio input and output capabilities
- Smart card reader
- USB ports that support hot-pluggable peripherals
- EnergyStar™ compliance

- No fan, switch, or disk
- Very low power consumption

The DTU acts as a frame buffer on the client side of the network. Applications run on the server and render their output to a *virtual frame buffer*. Sun Ray server software formats and sends the rendered output to the appropriate DTU, where the output is interpreted and displayed.

From the point of view of network servers, Sun Ray DTUs are identical except for their Ethernet MAC addresses. If a DTU ever fails, it can easily be replaced.

IP addresses are leased to each Sun Ray DTU when it is connected and can be reused when the DTU is disconnected. IP address leasing is managed by the Dynamic Host Configuration Protocol (DHCP). In cases where they already exist on a network that will support Sun Ray DTUs, separate DHCP servers may be useful for tasks such as assigning IP addresses and network parameters to the DTUs. The use of separate DHCP servers is not required. These questions are discussed in Chapter 7 and Appendix C.

Multihead Displays

Sun Ray Server Software supports the use of multiple displays connected to a single keyboard and pointer. This functionality is important for users who need extra screen real estate, for instance, to monitor many applications or systems simultaneously or to accommodate a single application, such as a large spreadsheet, across multiple screens. To use multiple screens, the administrator sets up multihead groups, consisting of two or more DTUs, for those users who need them. Administration of multihead groups is explained in Chapter 9.

Firmware Module

A small firmware module in each Sun Ray DTU can be updated from the server. The firmware module checks the hardware with a power-on self test (POST) and initializes the DTU. The Sun Ray DTU contacts the server to authenticate the user, and it also handles low-level input and output, such as keyboard, mouse, and display information. If there is a problem with the DTU, the module displays an on-screen display (OSD) icon to make it easier to diagnose. OSD icons are described in Appendix B.

Sun Ray Server Software

Sun Ray server software allows the administrator to configure network connections, select an authentication protocol, administer users, define desktop properties, monitor the system, and troubleshoot a wide variety of administration problems.

Sun Ray server software includes:

- User authentication and access control
- Encryption between the Sun Ray server and DTUs
- System administration tools
- Session management
- Device management, including application-level USB access
- Virtual device drivers for audio and serial, parallel, and mass storage USB devices

Sun Ray server software enables direct access to all Solaris X11 applications. Third-party applications running on the Sun Ray server can provide access to Microsoft Windows NT applications and a variety of legacy (mainframe) applications.

Authentication Manager

The Authentication Manager implements the chosen policies for identifying and authenticating users on Sun Ray DTUs. The Authentication Manager uses pluggable components called *modules* to implement various site-selectable authentication *policies*.

The Authentication Manager also verifies user identities and implements site access policies. The Authentication Manager is not visible to the user.

The interaction between the Authentication Manager and the DTU works as follows:

1. A user accesses a DTU.
2. The DTU sends the user's token information to the Authentication Manager and requests access. If a smart card is presented to the DTU, the smart card's type and ID are the token. If not, the DTU's Ethernet address is sent.
3. If the Authentication Manager runs through the entire list of modules and no module takes responsibility for the request, the user is denied.
4. If the user is accepted, the Authentication Manager starts an X Windows session for the user, which takes the user to the login screen. Solaris implementations use the `dtlogin` screen; Linux implementations use GDM.

Normally, the Sun Ray DTU looks for the `AuthSrvr` DHCP option and contacts that address. If that field has not been supplied, or if the server does not respond, the DTU sends a broadcast request for any authentication manager on its subnet.

As an alternative, the administrator can supply a list of servers. If the authentication list is specified, only addresses on the list are checked. The Authentication Manager addresses are tried in order until a connection is made.

The site administrator can construct a combination of the different modules and their options to implement a policy tailored to the site's needs.

The modules are:

- StartSession

Any type of token is accepted. Users are automatically passed through to the login window. This module is designed primarily for implementations in which Sun Ray DTUs replace workstations or PCs.

- Registered

The token is accepted *only* if the token has been registered in the Sun Ray administration database *and* the token is enabled. If the token does not meet these conditions, it is rejected. If accepted, the user is passed through to the login window. This module is designed for sites that want to restrict access to only certain users or DTUs.

Users can be registered in two ways, reflecting two possible policy decisions for the administrator:

- Central Registration

The administrator assigns smart cards and/or DTUs to authorized users and registers users' tokens in the Sun Ray administration database.

- Self-Registration

Users register themselves in the Sun Ray administration database. If this mode is enabled and the Authentication Manager is presented with an unregistered token, the user is prompted with a registration window. In this case, the user provides the same information a site administrator would request.

If self-registration is enabled, users can still be registered centrally. If a token has been registered but disabled, the user cannot re-register the token; the user must contact the site administrator to re-enable the token.

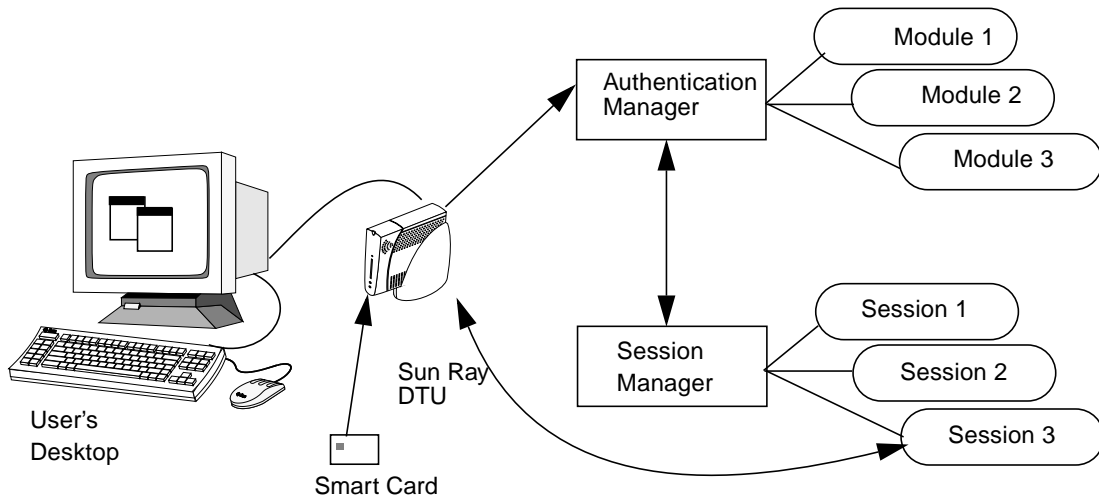

FIGURE 1-1 Authentication and Session Manager Interaction

Sessions and Services

A *session* consists of a group of services controlled by the Session Manager.

The session is associated with a user through an authentication token. A *service* is any application that can connect directly to the Sun Ray DTU. This can include audio, video, X servers, and device control of the DTU. For example, `dtmail` is not a service because it is accessed through an X server.

Session Manager

The Session Manager interacts with the Authentication Manager and directs services to the user. The Session Manager is used at start up for services, for managing screen real estate, and as a rendezvous point for the Authentication Manager.

The Session Manager keeps track of sessions and services by mapping services to sessions and binding and unbinding related services to or from a specific DTU. The Session Manager takes authentication only from authorized Authentication Managers listed in the `/etc/opt/SUNWut/auth.permit` file.

The steps below describe how the process starts and ends:

1. After a user's token is authenticated, the Authentication Manager determines whether a session exists for that token. If a session does not exist, the Authentication Manager asks the Session Manager to create a session and then

starts the appropriate service(s) for the session according to the policy decisions taken by the administrator. Creating a session usually involves starting an `xserver` process for the session.

2. When services are started, they explicitly join the session by contacting the Session Manager.
3. The Authentication Manager informs the Session Manager that the session associated with the token is to be connected to a specific Sun Ray DTU. The Session Manager then informs each service in the session that it should connect directly to the DTU.
4. The Authentication Manager determines that the session associated with a token should be disconnected from an DTU. The Authentication Manager notifies the Session Manager which, in turn, notifies all the services in the session to disconnect.
5. The Session Manager mediates control of the screen real estate between competing services in a session and notifies the services of changes in screen real estate allocation.



Caution – It is important to keep the session ID private. If the user’s session ID is revealed, unauthorized applications can connect directly to the DTU. The `xprop(1)` command can reveal an end user’s secret session ID. Also, careless use of the `xhost(1)` command (for example, typing `xhost +`) can allow an intruder to use `xprop` to capture a user’s session ID. This action can expose the user’s screen images and keyboard input to anyone interested.

Tip – Use `xhost username@system` to enable only those people you specify to access the display and the user’s DTU.

The Session Manager is consulted only if the state of the session changes or if other services are added. When a user’s token is no longer mapped to an DTU (for example, when a card is removed), the Session Manager disconnects the services from the DTU, but the services remain active on the server. For example, programs attached to the X server continue to run although their output is not visible. The Session Manager daemon must continue running all the time.

Note – To verify that the Session Manager daemon is running, use the `ps` command and look for `utssessiond`.

If the Authentication Manager quits, the Session Manager disconnects all the sessions it authorized and tells them that they have to be re-authenticated. The services are disconnected but still active. If the Session Manager is disrupted, it restarts automatically. Each service contacts the Session Manager to request reattachment to a particular session.

Sun Management Center

The Sun™ Management Center (SunMC) software monitors managed objects in the Sun Ray system. Objects that can be managed by default include the Sun Ray system itself, Sun Ray services, failover groups, interconnects, and desktops.

Each managed object is monitored separately and has independent alarm settings.

Sun Management Center software also monitors Sun Ray Server Software daemons that authenticate users, start sessions, manage devices, and handle DHCP services. Chapter 8 describes how to use the SunMC to monitor a Sun Ray system. For problems with the SunMC, see “Troubleshooting the Sun Management Center” on page 224.

CLI and Admin GUI

Sun Ray Server Software has both a command-line interface (CLI) and a graphical user interface for administrative functions. The CLI is the recommended interface for enabling assistive technologies; the Sun Ray Administration Tool (Admin GUI) is provided for convenience.

Data Store

Sun Ray Server Software 3 provides a private data store service, the Sun Ray Data Store (SRDS). The SRDS provides group-wide access to SRSS administration data.

Controlled Access (Kiosk) Mode

Sun Ray DTUs are becoming more common in public locations, such as airports, where anonymous users have limited access to specific applications. See Chapter 10 for details.

Network Components

In addition to the servers, server software, DTUs, smart cards, and peripheral devices, such as local printers, the Sun Ray system needs a well-designed network, configured in one of several possible ways, including:

- Dedicated interconnect
- VLAN (Virtual Local Area Network)
- LAN (Local Area Network), with or without network routers
- Low-bandwidth¹ WAN (Wide Area Network)

Various types of network configuration are discussed in depth in Chapter 7.

Sun Ray Interconnect Fabric

Early Sun Ray implementations relied on dedicated interconnects, using physically dedicated Ethernet networks or logically dedicated networks. Sun Rays can now be deployed on existing Local Area Network (LAN) infrastructure, eliminating the requirement for a dedicated interconnect.

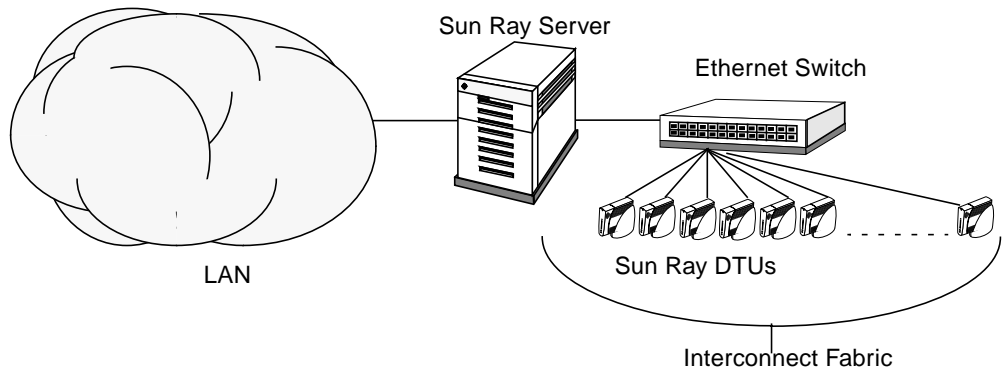

FIGURE 1-2 Sun Ray System with a Dedicated Interconnect Fabric

The Sun Ray interconnect fabric is based on 10/100BASE-T Ethernet technology, using layer-2 or layer-3 switches and Category 5 wiring. Each Sun Ray DTU is attached to the interconnect fabric through its built-in 10/100BASE-T interface.

The following sections illustrate some conservative methods of providing good desktop performance to Sun Ray users at a low cost. Many other network scenarios are possible.

1. Bandwidth less than 2 Mbps.

VLAN Implementation

VLANs logically partition a single physical interconnect into two or more broadcast domains. VLANs are commonly configured to implement virtual subnets in a shared physical interconnect. However, because VLANs must share backplane and link bandwidth, they are not true dedicated interconnects.

Implementing a Sun Ray interconnect through VLANs creates a logically dedicated connection, but can also mean sharing physical resources with uncontrolled, non-Sun Ray traffic. These resources could be the limited backplane bandwidth within a switch or on a link that carries multiple VLANs between switches (see FIGURE 1-3). If these resources are consumed by other devices, significant amounts of Sun Ray DTU traffic might be dropped and the results seen as horizontal bands or blocks on the user's display.

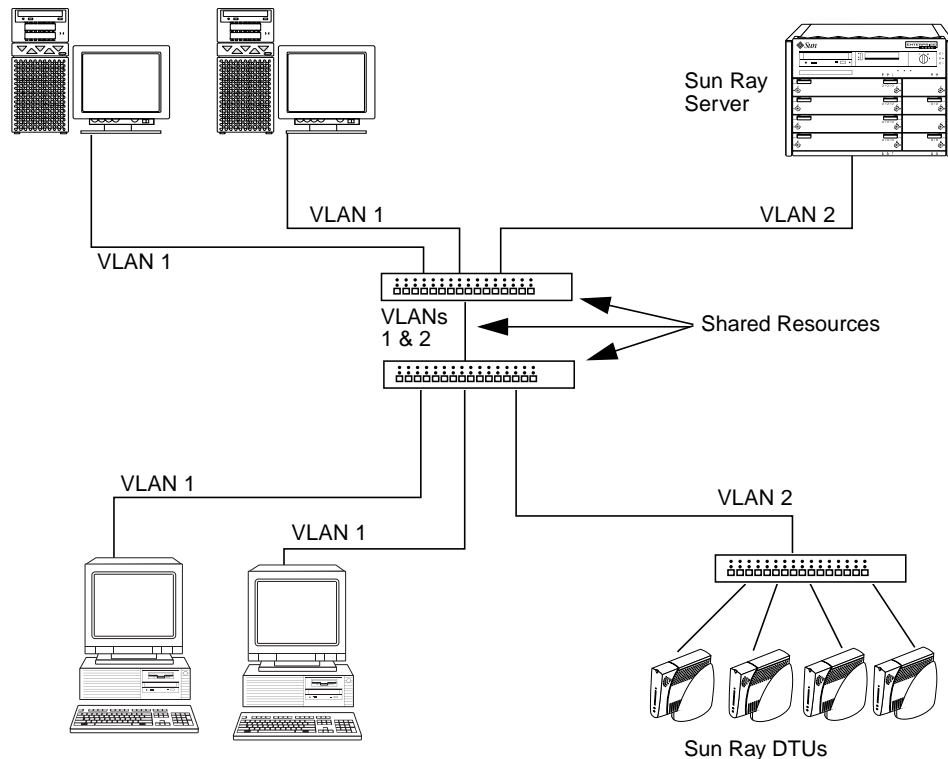

FIGURE 1-3 Example of Shared Physical Resources in Multiple VLANs Configuration

Since switch manufacturers configure their products differently, please refer to the documentation provided with your switch and refer all questions relating to setting up or configuring VLANs to your switch manufacturer.

Implementing the interconnect with a physically dedicated and isolated set of Ethernet switches was recommended because it is easy and reliable. For instance:

- Only layer 2 switches are required.
- The only switch configuration required is to enable fast boot times.
- No ongoing switch configuration and management is required.
- Issues of bandwidth and poor topology are greatly reduced.

LAN Implementation

With Sun Rays deployed on a LAN, users can exercise session mobility across a much larger “domain”—a huge convenience. For basic instructions on configuring different types of networks for Sun Ray implementation, see “Basic Network Topology” on page 30 of the *Sun Ray Server Software 3 Installation and Configuration Guide*. For a more detailed discussion of network taxonomy and configuration, see “Deployment on Shared Networks” on page 109.

Physical Connections

The physical connection between the Sun Ray server and Sun Ray clients relies on standard switched Ethernet technology.

To boost the power of the interconnect and shield Sun Ray DTU users from the network interaction taking place at every display update, 100 Mbps switches are preferred.

There are two basic types of 100 Mbps switches:

- Low-capacity switches—These switches have 10/100 Mbps interfaces for each port.
- High-capacity switches—These switches have 10/100 Mbps interfaces for each terminal port, but one or more gigabit interfaces to attach to the server.

Either type of switch can be used in the interconnect. They can be managed or unmanaged; however, some managed switches may require basic configuration to be used on a Sun Ray network.

Server-to-switch bandwidth should be scaled based on end-user multiplexing needs so that the server-to-switch link does not become overly saturated. Gigabit uplink ports on the switch provide high-bandwidth connections from the server, thus increasing the number of supportable clients. The distance between the server and the switch can also be extended using gigabit fiber-optic cabling.

The interconnect may be completely dedicated and private, or a VLAN, or it may be part of the corporate LAN. For private interconnects, the Sun Ray server uses at least two network interfaces: one for the corporate LAN, the other for the Sun Ray interconnect.

Even in a LAN deployment, two server network interfaces are recommended: one to connect to the general LAN and one to connect the server to back-end services, such as file servers, compute grids, and large databases.

Deployment Examples

There is no physical or logical limit to the ways that a Sun Ray system can be configured. The following sections offer some typical examples.

Small Deployments

For smaller deployments, such as those with between five and 50 Sun Ray DTUs, the Sun Ray server uses a single 100BASE-T card to connect to a 100BASE-T switch. This switch, in turn, connects to the Sun Ray DTUs. With five or fewer DTUs, a wireless interconnect works acceptably at 10 Mbytes.

For example, in FIGURE 1-2 a Sun Enterprise™ server with a Sun card 10/100BASE-T card and a 24-port 10/100BASE-T switch can easily support 23 users performing standard desktop activities.

Medium to Large Deployments

For larger departments with groups consisting of hundreds or thousands of Sun Ray DTUs, the Sun Ray server uses a gigabit Ethernet card to connect to large 10/100BASE-T switches. Especially with the low-bandwidth enhancements to SRSS, there is no performance need to have more than one gigabit link from the server to the Sun Ray DTU's network.

A 100-user departmental system, for example, consisting of a Sun Enterprise server, one gigabit Ethernet card, and two large (48-port and 80-port) 10/100BASE-T switches delivers services to the 100 Sun Ray DTUs (see FIGURE 1-4).

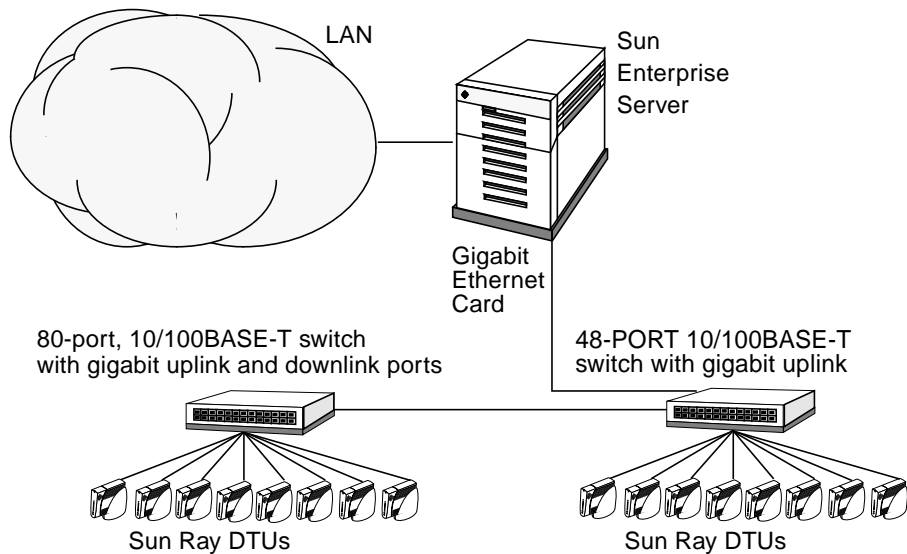

FIGURE 1-4 Small Deployment Scenario

Failover Group Scenario

Sun Ray servers can be bound together to create failover groups. A failover group, comprising two or more servers, provides users with a higher level of availability in case one servers become unavailable due to a network or system failure.

When a server in a failover group goes down, whether for maintenance, a power outage, or any other reason, each Sun Ray DTU connected to it reconnects to another server in the failover group. The DTU connects to a previously existing session for the current token, if there is one, on another server; if there is no existing session, the DTU connects to a server selected by the load balancing algorithm. This server presents a login screen to the user, who must log in again to create a new session. The session on the failed server is lost. Failover groups are discussed in Chapter 11 as well as in the *Sun Ray Server Software 3 Installation and Configuration Guide*.

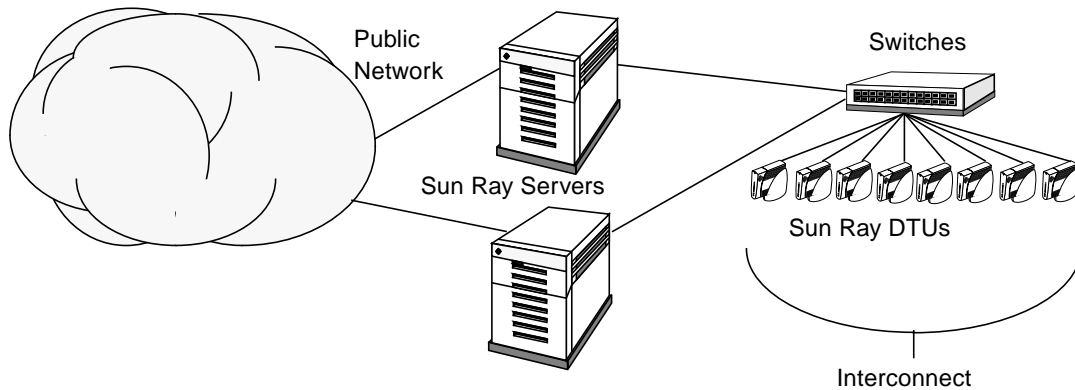

FIGURE 1-5 Simple Failover Group

Security Considerations

Using switched network gear for the last link to the DTUs makes it hard for a malicious PC user or network snooper at one of the network ports to obtain unauthorized information. Because switches send packets only to the proper output port, a snooper plugged into another port receives no unauthorized data. If the server and wiring closet are secure, the last step is switched, and the DTU is plugged directly into the wall jack, then it is very difficult to intercept communications between the server and the DTU. SRSS encryption features also help to protect sensitive data by providing the options to encode keyboard input and display traffic.

Command-Line Interface

The Command-Line Interface (CLI) is the recommended interface for enabling assistive technologies.

This chapter contains the following information:

- “Supported Commands” on page 15
- “Session Redirection” on page 19
- “Changing Policies” on page 21
- “Configuring Interfaces on the Sun Ray Interconnect Fabric” on page 23
- “Managing Firmware Versions” on page 26
- “Restarting the Sun Ray Data Store” on page 27
- “Smart Card Configuration Files” on page 28
- “Using the utcapture Tool” on page 30

Supported Commands

Commands that can be executed from the command line are listed in TABLE 2-1, and a few of the most important commands are documented in this chapter. For further information on executing these commands, see the man page for the command in question.

To view any of the specific commands for the Sun Ray system, type:

```
% man -M /opt/SUNWut/man command
```

or type:

```
% setenv MANPATH=/opt/SUNWut/man  
% man command
```

TABLE 2-1 Supported Commands

Command	Definition
utaction	The <code>utaction</code> program provides a way to execute commands when a Sun Ray DTU session is connected or disconnected.
utadm	The <code>utadm</code> command manages the private network, shared network, and DHCP (Dynamic Host Configuration Protocol) configuration for the Sun Ray interconnect.
utcapture	The <code>utcapture</code> command connects to the Authentication Manager and monitors packets sent and packets dropped between the Sun Ray server and the Sun Ray DTUs.
utcard	The <code>utcard</code> command allows configuration of different types of smart cards in the Sun Ray administration database
utconfig	The <code>utconfig</code> command performs the initial configuration of the Sun Ray server and supporting administration framework software.
utcrypto	The <code>utcrypto</code> command is a utility for security configuration.
utdesktop	The <code>utdesktop</code> command allows the user to manage Sun Ray DTUs connected to the Sun Ray server that the command is run on.
utdetach	The <code>utdetach</code> command disconnects the current non-smart card mobile session or authenticated smart card session from its respective Sun Ray DTU. The session is not destroyed but put into a detached state. The session can be accessed if the same user token (user name) is presented to the Sun Ray server.
utdiskadm	The <code>utdiskadm</code> utility is a tool for Sun Ray mass storage administration.
utdssync	The <code>utdssync</code> command converts the port number for the Sun Ray Data Store service to the new default port on servers in a failover group, then forces all servers in the group to restart Sun Ray services.
uteject	The <code>uteject</code> command is used to eject media from a removable storage media device.
utfwadm	The <code>utfwadm</code> command manages firmware versions on the Sun Ray DTUs.
utfwload	The <code>utfwload</code> command is used primarily to force the download of new firmware to a DTU running older firmware than its server.

TABLE 2-1 Supported Commands (*Continued*)

Command	Definition
<code>utfwsync</code>	The <code>utfwsync</code> command refreshes the firmware level on the Sun Ray DTUs to what is available on the Sun Ray servers in a failover group. It then forces all the Sun Ray DTUs within the group to restart.
<code>utgroupsig</code>	The <code>utgroupsig</code> command sets the failover group signature for a group of Sun Ray servers. The <code>utgroupsig</code> command also sets the Sun Data Store <code>rootpw</code> used by Sun Ray to a value based on the group signature. Although <code>utgroupsig</code> sets the <code>rootpw</code> in the <code>utdsd.conf</code> file, it does <i>not</i> set the admin password, which is a separate entity, in the Admin database.
<code>utgstatus</code>	The <code>utgstatus</code> command allows the user to view the failover status information for the local server or for the named server. The information that the command displays is specific to that server at the time the command is run.
<code>utinstall</code>	The <code>utinstall</code> utility installs, upgrades, and removes Sun Ray Server Software. All software required to support the Sun Ray server is installed, including the administration framework, Solaris operating environment patches, and any patches required by the framework.
<code>utkiosk</code>	The <code>utkiosk</code> script is used to import/export kiosk configuration information into the LDAP database.
<code>utmhadm</code>	The <code>utmhadm</code> command provides a way to administer Sun Ray server multihead terminal groups. The information that <code>utmhadm</code> displays and that is editable is stored in the Sun Ray administration database.
<code>utmhconfig</code>	The <code>utmhconfig</code> tool allows an administrator to list, add, or delete multiheaded groups easily.
<code>utmhscreen</code>	The <code>utmhscreen</code> tool draws a window displaying the current session on each screen, with the current screen highlighted for easy identification. This tool is automatically launched for users during the X server startup process (session creation).
<code>utmount</code>	The <code>utmount</code> command is used to mount a file system on a Sun Ray mass storage device.
<code>utmountd</code>	The <code>utmountd</code> command is used to perform mount and umount operations on Sun Ray mass storage devices managed by <code>utstoraged</code> .
<code>utpolicy</code>	The <code>utpolicy</code> command sets and reports the policy configuration of the Sun Ray Authentication Manager, <code>utauthd(1M)</code> . This command's <code>-i</code> and <code>-t</code> options were deprecated as of the 2.0 release. Please continue to use the <code>utpolicy</code> command for policy changes, but use the <code>utrestart</code> command instead of <code>utpolicy -i</code> , and use <code>utreader</code> instead of <code>utpolicy -t</code> .
<code>utpreserve</code>	The <code>utpreserve</code> command saves existing Sun Ray Server Software configuration data to the <code>/var/tmp/SUNWut.upgrade</code> directory.
<code>utpw</code>	The <code>utpw</code> command changes the Sun Ray administrator password (also known as the UT admin password) used by the Web-based and command-line administration applications.
<code>utquery</code>	The <code>utquery</code> command collects DHCP information from the Sun Ray DTUs.
<code>utrcmd</code>	The <code>utrcmd</code> program provides a way to run Sun Ray administrative commands remotely. The <code>utrcmd</code> program contacts the <code>in.utrcmdd</code> daemon on the remote <code>hostname</code> and executes the specified <i>command</i> with the specified arguments, <i>args</i> (if any).
<code>utreader</code>	The <code>utreader</code> command is used to add, remove, and configure token readers.

TABLE 2-1 Supported Commands (*Continued*)

Command	Definition
<code>utreplica</code>	The <code>utreplica</code> command configures the Sun Ray Data Store server to enable replication of administered data from a designated primary server to each secondary server in a failover group. The <code>-z</code> option is useful for updating the port number.
<code>utresadm</code>	The <code>utresadm</code> command allows an administrator to control the resolution and refresh rate of the video monitor signal (persistent monitor settings) produced by the Sun Ray unit.
<code>utresdef</code>	The <code>utresdef</code> command lists the monitor resolutions and refresh rates that can be applied to Sun Ray units through the <code>utresadm</code> command.
<code>utrestart</code>	The <code>utrestart</code> command is used to start Sun Ray services. It is highly recommended as a substitute for the old <code>utglpolicy</code> and <code>utpolicy -i</code> commands.
<code>utselect</code>	The <code>utselect</code> command presents the output of <code>utswitch -l</code> in a window and allows mouse-based selection of a Sun Ray server to which the Sun Ray DTU in use is reconnected.
<code>utsession</code>	The <code>utsession</code> command lists and manages Sun Ray sessions on the local Sun Ray server.
<code>utset</code>	Use <code>utset</code> to view and change Sun Ray DTU settings.
<code>utsettings</code>	The <code>utsettings</code> command opens a Sun Ray Settings dialog box that allows the user to view or change audio, visual, and tactile settings for the Sun Ray DTU.
<code>utsummc</code>	The <code>utsummc</code> command adds the Sun Ray Server Software 3 module to the Sun Management Center (SunMC) and loads it to permit monitoring of Sun Ray Server Software. The <code>utsummc</code> command can also remove the Sun Ray Server Software 3 module from SunMC.
<code>utsummcinstall</code>	Use <code>utsummcinstall</code> to install and uninstall the Sun Ray module for SunMC on a SunMC server where Sun Ray Server Software is not installed.
<code>utswitch</code>	The <code>utswitch</code> command allows switching a Sun Ray DTU among Sun Ray servers in a failover group. It can also list the existing sessions for the current token.
<code>utsvc</code>	The <code>utsvc</code> script restarts the Sun Ray Server Software and, due to its location in <code>/etc/init.d</code> , is executed upon startup of the actual server. Use <code>utrestart</code> instead of <code>utsvc</code> .
<code>utusbadm</code>	The <code>utusbadm</code> command is used to enable or disable access to USB devices.
<code>utumount</code>	The <code>utumount</code> command is used to unmount a file system from a Sun Ray mass storage device.
<code>utuser</code>	The <code>utuser</code> command allows the administrator to manage Sun Ray users registered on the Sun Ray server that this command is run on. It also provides information on the currently inserted token (smart card) for a specified DTU that is configured as a token reader.
<code>utwall</code>	The <code>utwall</code> utility sends a message or an audio file to users having an Xsun (X server unique to Sun Ray) process. The messages can be sent in email and displayed in a pop-up window.
<code>utwho</code>	The <code>utwho</code> script assembles information about display number, token, logged-in user, etc., in a compact format.
<code>utxconfig</code>	The <code>utxconfig</code> program provides X server configuration parameters for users of Sun Ray DTU sessions.

▼ To Stop Sun Ray Services

- Type:

```
# /etc/init.d/utsvc stop
```

▼ To Start Sun Ray Services

- Type:

```
# /opt/SUNWut/sbin/utrestart
```

This procedure starts Sun Ray services without clearing existing sessions.

Or

- Type:

```
# /opt/SUNWut/sbin/utrestart -c
```

This procedure starts Sun Ray services and clears existing sessions.

Session Redirection

In addition to automatic redirection after a user's token has been authenticated, whether via smart card token or direct login, the `utselect` graphical user interface (GUI) or the `utswitch` command can be used to redirect the session to a different server.

▼ To Redirect to a Different Server

- From a shell window on the DTU, type:

```
% /opt/SUNWut/bin/utselect
```

The selections in the window are sorted in order of the most current to least current active sessions for the token ID.

In FIGURE 2-1, the Server column lists the servers accessible from the DTU. The Session column reports the DISPLAY variable X session number on the server if one exists. In the Status column, Up indicates that the server is available. The first server in the list is highlighted by default. Select a server from the list or enter the name of a server in the Enter server: field. If a server without an existing session is selected, a new session is created on that server.

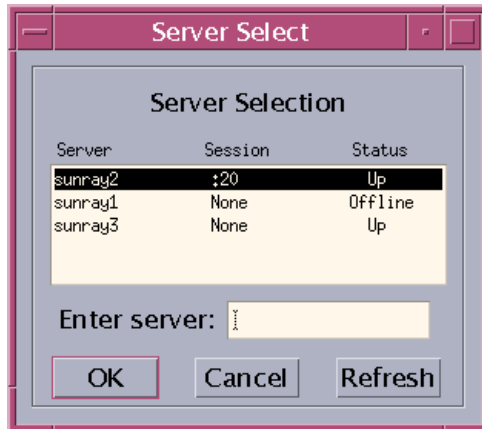

FIGURE 2-1 The Server Selection (utselect) GUI

The OK button commits the selection of the highlighted or manually entered server. The Cancel button dismisses the GUI without making any changes to the session. The Refresh button reloads the window with the most current information.

Note – If only one server in the failover group is up, it is displayed in the utselect GUI. However, if selectAtLogin is set to *true* in the /etc/opt/SUNWut/auth.props file, the GUI is not displayed because there appears to be only one server in the failover group.

▼ To Redirect a DTU Manually

- From a shell window on the DTU, type:

```
% /opt/SUNWut/bin/utswitch -h host [ -k token ]
```

where *host* is the host name or IP address of the Sun Ray server to which the selected DTU is redirected, and *token* is the user's token ID.

▼ To List Available Hosts

- From a shell window, type:

```
% /opt/SUNWut/bin/utswitch -l
```

Hosts available from the Sun Ray DTU are listed.

▼ To Select a Server with the Latest Session

- In a shell window, type:

```
% /opt/SUNWut/bin/utswitch -t
```

The DTU is redirected to the server with the latest session connect time.

Changing Policies

The `utglpolicy` command and the `utpolicy` options `-i` and `-t` were deprecated in release 2.0. Consequently, please:

- Use the `utrestart` command instead of the `-i` option to `utpolicy`.
- Use the `utreader` command instead of the `-t` option to `utpolicy`.
- Use the `utpolicy` command to make policy changes.

When a policy is set with `utpolicy`, the group policy is set automatically, so all that is needed at that point is to reset or restart services. This eliminates the need for `utglpolicy`.

Tip – Use the `utrestart -c` command instead of rebooting the server.

TABLE 2-2 `utrestart` Commands

Command/Option	Result
<code>/opt/SUNWut/sbin/utrestart</code>	Use this option if a minor policy change was made, such as adding a dedicated token reader. With such minor changes, it is not necessary to terminate existing sessions.
<code>/opt/SUNWut/sbin/utrestart -c</code>	Use this option if a significant policy change has been made. All existing sessions are terminated.

Enabling and Disabling USB Devices

All USB device access is enabled by default. To disable USB devices, the administrator must explicitly use the provided command line tool or GUI.

This configuration affects all servers in a group and all DTUs connected to that group. The devices' access can only be updated by a privileged administrator.

▼ To Enable All USB Devices

The following commands enable or disable access to USB devices. Before any change can take effect, you must restart Sun Ray services with a cold restart, which terminates all Sun Ray sessions.

- Use the `utusbadm` command with the `-e` option:

```
# /opt/SUNWut/sbin/utusbadm -e
```

▼ To Disable All USB Device Access

- Use the `utusbadm` command with the `-d` option:

```
# /opt/SUNWut/sbin/utusbadm -d
```

▼ To Perform a Cold Restart

- Use the `utrestart` command with the `-c` option:

```
# /opt/SUNWut/sbin/utrestart -c
```

▼ To Determine the Current State of Devices

To determine whether or not USB devices are currently enabled:

- Use the `utusbadm` command:

```
# /opt/SUNWut/sbin/utusbadm
```

This displays the ENABLED or DISABLED state of the devices.

Configuring Interfaces on the Sun Ray Interconnect Fabric

Use the `utadm` command to manage the Sun Ray interconnect fabric.

Note – If the IP addresses and DHCP configuration data are not set up properly when the interfaces are configured, then the failover feature will not work as expected. In particular, configuring the Sun Ray server’s interconnect IP address as a duplicate of any other server’s interconnect IP address may cause the Sun Ray Authentication Manager to generate “Out of Memory” errors.

Note – If you make manual changes to your DHCP configuration, you will have to make them again whenever you run `utadm` or `utfwadm`.

Tip – If you issue a <CTRL>C signal while performing `utadm` configuration, `utadm` may not function correctly the next time it is invoked. To correct this condition, type: `dhtadm -R`.

▼ To Add an Interface

- Type:

```
# /opt/SUNWut/sbin/utadm -a interface_name
```

This command configures the network interface `interface_name` as a Sun Ray interconnect. Specify a subnet address or use the default address, which is selected from reserved private subnet numbers between 192.168.128.0 and 192.168.254.0.

Note – If you choose to specify your own subnet, make sure it is not already in use.

After an interconnect is selected, appropriate entries are made in the `hosts`, `networks`, and `netmasks` files. (These files are created if they do not exist.) The interface is activated.

Any valid Solaris network interface can be used. For example:

```
hme[0-9], qfe[0-3]
```

▼ To Delete an Interface

- Type:

```
# /opt/SUNWut/sbin/utadm -d interface_name
```

This command deletes the entries that were made in the `hosts`, `networks`, and `netmasks` files and deactivates the interface as a Sun Ray interconnect.

▼ To Print the Sun Ray Private Interconnect Configuration

- Type:

```
# /opt/SUNWut/sbin/utadm -p
```

For each interface, this command displays the hostname, network, netmask, and number of IP addresses assigned to Sun Ray units by DHCP.

▼ To Add a LAN Subnet

- Type:

```
# /opt/SUNWut/sbin/utadm -A subnet_number
```

▼ To Delete a LAN Subnet

- Type:

```
# /opt/SUNWut/sbin/utadm -D subnet_number
```

▼ To Print Public LAN Subnets

- Type:

```
# /opt/SUNWut/sbin/utadm -l
```

▼ To Remove All Interfaces and Subnets

Use the `utadm -r` command to prepare for removal of the Sun Ray Server Software.

- **Type:**

```
# /opt/SUNWut/sbin/utadm -r
```

This command removes all of the entries and structures relating to all of the Sun Ray interfaces and subnets.

Managing Firmware Versions

Use the `utfwadm` command to keep the firmware version in the PROM on Sun Ray DTUs synchronized with that on the server.

Note – If the DHCP *version* variable is defined, then when a new DTU is plugged in, its firmware is changed to the firmware version on the server.

Note – If you make manual changes to your DHCP configuration, you will have to make them again whenever you run `utadm` or `utfwadm`.

▼ To Update All the DTUs on an Interface

- **Type:**

```
# /opt/SUNWut/sbin/utfwadm -A -a -n interface
```

Tip – To force a firmware upgrade, power-cycle the DTUs.

▼ To Update a DTU Using the Ethernet (MAC) Address

- Type:

```
# /opt/SUNWut/sbin/utfwadm -A -e MAC_address -n interface
```

Restarting the Sun Ray Data Store

If you restart the Sun Ray Data Store daemon (`utdsd`), you must also restart the Sun Ray Authentication Manager. The Sun Ray Data Store (SRDS) daemon may need to be restarted if you change one of its configuration parameters. The following procedure shows the correct order of the steps to take if you need to restart SRDS.

▼ To Restart Sun Ray Data Store

1. Stop the Sun Ray services:

```
# /etc/init.d/utsvc stop
```

2. Stop the Sun Ray Data Store daemon:

```
# /etc/init.d/utds stop
```

3. Restart the Sun Ray services:

```
# /opt/SUNWut/sbin/utrestart
```

Smart Card Configuration Files

Tip – Use the Administration Tool or the `utcard` command to add additional smart card vendor configuration files.

Smart card configuration files are available from a variety of sources, including Sun. For more ample information on smart cards, see the latest version of the *Solaris Smart Card Administration Guide*.

▼ To Load a Configuration File Into the Directory

- Copy the vendor configuration file containing the vendor tags to the following location:

```
# cp vendor.cfg /etc/opt/SUNWut/smartcard
```

The additional vendor cards are displayed under the Available column in the Add page in the Administration Tool.

Configuring and Using Token Readers

Some manufacturers print the smart card ID on the card itself, but many do not. Since all the administrative functions refer to this token ID, Sun Ray Server Software provides a way to designate one or more specific DTUs as dedicated token readers. Site administrators can use these dedicated DTUs to administer Sun Ray users. When you enable an authentication policy with registered users, be sure to specify smart card IDs.

In the example configuration in FIGURE 2-2, the second DTU acts as a token reader.

Note – The token reader is not used for normal Sun Ray services, so it does not need a keyboard, mouse, or monitor.

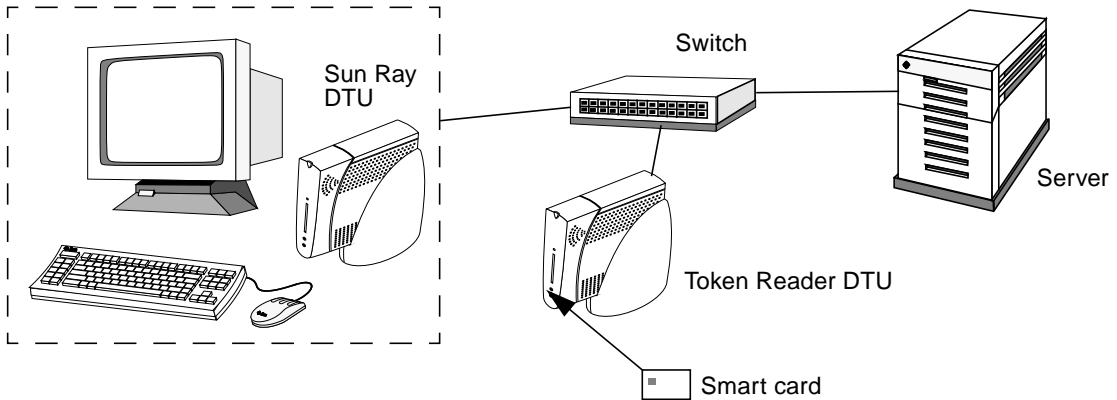

FIGURE 2-2 Using a Token Reader to Register Smart Cards

▼ To Configure a Token Reader

The `utreader` command specifies a DTU for registering smart cards. When a DTU is configured as a token reader, inserting or removing a smart card does not cause session mobility to occur; instead, any session connected to the DTU remains connected to that DTU over a card movement event.

Token reader mode is useful when you want to determine the raw token ID of a smart card. For example, to configure the DTU with MAC address `0800204c121c` as a token reader, issue the following `utreader` command:

```
# /opt/SUNWut/sbin/utreader -a 0800204c121c
```

To re-enable the DTU with MAC address `0800204c121c` to recognize card movement events and perform session mobility based on the smart card inserted into the DTU:

```
# /opt/SUNWut/sbin/utreader -d 0800204c121c
```

To unconfigure all token readers on this server:

```
# /opt/SUNWut/sbin/utreader -c
```

▼ To Get a Token ID From a Token Reader

- Type the following command:

```
# /opt/SUNWut/sbin/utuser -r Token Reader
```

where *Token Reader* is the MAC address of the DTU containing the token (smart card) whose ID you want to read. Insert the token into the DTU and run the `utuser` command. This command queries the DTU for the token's ID and, if successful, displays it. For example:

```
# /opt/SUNWut/sbin/utuser -r 08002086e18f
Insert token into token reader '08002086e18f' and press return.
Read token ID 'mondex.9998007668077709'
```

Using the `utcapture` Tool

The `utcapture` tool connects to the Authentication Manager and collects data about the packets sent and packets dropped between the Sun Ray server and the DTU. The data in TABLE 2-3 is then displayed on the screen in the following format:

TABLE 2-3 Data Elements Displayed

Data Element	Description
TERMINALID	The MAC address of the DTU
TIMESTAMP	The time the loss occurred in year-month-day-hour-minute-second format. Example: 20021229112512
TOTAL PACKET	Total number of packets sent from server to DTU
TOTAL LOSS	Total number of packets reported as lost by DTU
BYTES SENT	Total number of bytes sent from server to DTU
PERCENT LOSS	Percentage of packets lost between the current and previous polling interval
LATENCY	Time in milliseconds for a round trip from DTU to server.

Tip – If Sun Ray DTU traffic loss is more than .1%, allocate higher priority to the VLAN that carries Sun Ray DTU traffic. For more information on how to change the priority, please refer to the manufacturer’s documentation for your switch.

The following `utcapture` options are supported:

TABLE 2-4 `utcapture` Options

Option	Definition
<code>-h</code>	Help for using the command.
<code>-r</code>	Dump output to <code>stdout</code> in raw format. By default, data is dumped when there is a packet loss. With this option, the data is always dumped to <code>stdout</code>
<code>-s server</code>	Name of server on which the Authentication Manager is running. By default, it is the same host that is running <code>utcapture</code> .
<code>-i filename</code>	Process raw data from a file specified by filename and dump to <code>stdout</code> only the data for those DTUs that had packet loss.
<code>desktopID</code>	Collects the data for the specified DTUs only. DTUs are specified on the command line by their desktop IDs separated by a space. By default, data for all currently active desktops is collected.

▼ To Start `utcapture`

From a command line, enter one of the following commands

```
% /opt/SUNWut/sbin/utcapture -h
```

This command lists the help commands for the `utcapture` tool

```
% /opt/SUNWut/sbin/utcapture
```

This command captures data every 15 seconds from the Authentication Manager running on the local host and then writes it to `stdout` if there is any change in packet loss for a DTU

```
% /opt/SUNWut/sbin/utcapture -r > raw.out
```

This command captures data every 15 seconds from the Authentication Manager that is running on the local host and then writes it to `stdout`.

```
% /opt/SUNWut/sbin/utcapture -s sunray_server5118.eng \  
080020a893cb 080020b34231
```

This command captures data every 15 seconds from the Authentication Manager running on `server5118.eng` and then writes the output to `stdout` if there is any change in packet loss for the DTU with ID `080020a893cb` or `080020b34231`.

```
% /opt/SUNWut/sbin/utcapture -i raw-out.txt
```

This command processes the raw data from the input file `raw-out.txt` and then writes to `stdout` only the data for those DTUs that had packet loss.

Administration Tool

The Sun Ray Administration Tool (Admin GUI) enables administration of Sun Ray users and DTUs; however, the Command-Line Interface (CLI), documented in Chapter 2, is the recommended interface for enabling assistive technologies.

This chapter is divided into the following sections:

- “Administration Data” on page 34
- “Logging In” on page 34
- “Changing Policies” on page 37
- “Restarting Sun Ray Services” on page 39
- “Token Readers” on page 40
- “Managing Desktops” on page 45
- “Sun Ray DTU Settings” on page 50
- “Managing Multihead Groups” on page 51
- “Examining Log Files” on page 55
- “Managing Smart Cards” on page 56
- “Sun Ray System Status” on page 61
- “Administering Users” on page 62
- “Controlled Access Mode” on page 74
- “Managing Sessions” on page 77

Note – This chapter describes a standalone server. Servers in failover groups are discussed in Chapter 11.

Administration Data

Sun Ray administration data comes from two sources:

- An internal database

The internal database keeps persistent administration data and grants read access to all internal database clients; however, it allows changes only by those internal database clients that connect as the privileged `utadmin` user.

- The Authentication Manager

The authentication manager is queried as needed for dynamic data.

Tip – Although Sun Ray administration data is accessible through standard database interfaces and applications, to avoid operational errors, do not modify data except with the Administration Tool.

Logging In

The Administration Tool allows you to administer Sun Ray users and DTUs from a web browser.

▼ To Log Into the Administration Tool

1. Log in to your Sun Ray server's console or any DTU attached to it.
2. Start a browser.
3. Type the following URL:

`http://hostname:1660`

Tip – If you chose a different port number when you configured the Sun Ray supporting software, substitute that number for “1660” in the URL above.

If you get a message denying access, make sure that:

- You are running a browser on the Sun Ray server or one of its DTUs.
- The browser is not using a different machine as an HTTP proxy server (to proxy the connection to the HTTP server (web server)).

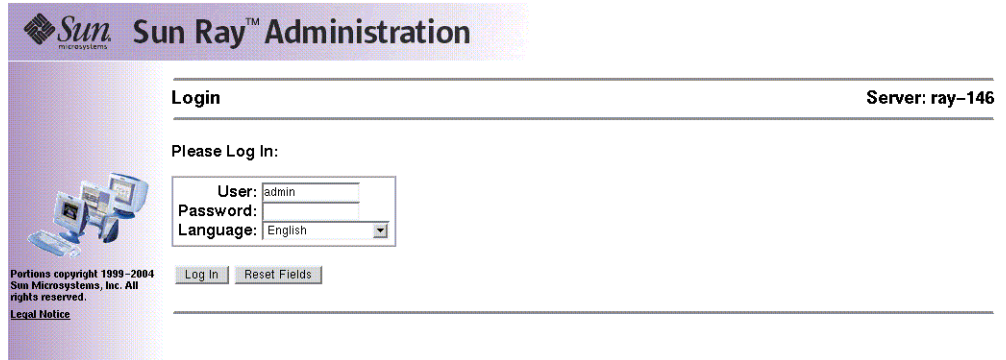

The screenshot shows the Sun Ray Administration login interface. At the top left is the Sun Microsystems logo. The main title is 'Sun Ray™ Administration'. On the right, it says 'Server: ray-146'. Below the title is a 'Login' section. It says 'Please Log In:' followed by three input fields: 'User' with 'admin' entered, 'Password' (empty), and 'Language' with a dropdown menu showing 'English'. Below these fields are two buttons: 'Log In' and 'Reset Fields'. On the left side of the login area, there is a small graphic of a computer monitor and keyboard, and some copyright text: 'Portions copyright 1999-2004 Sun Microsystems, Inc. All rights reserved. Legal Notice'.

FIGURE 3-1 Login Window

4. Enter the administrator user name `admin` and the administration password you specified when you configured the Sun Ray Server Software.

Note – Only `admin` can be entered in the User text box.

5. Click the Log In button.

The Summary Status window is displayed.

Use the navigation bar on the left to navigate through the Administration Tool.

Note – If the session is inactive for 30 minutes, you must log in again.

Sun Ray Administration Server: ray-146

Summary Status

Sun Ray Information	
Sun Ray Server Software Version:	3.0
Fallover Group Role:	Primary
Desktops Connected:	0
Total Sessions:	0
Logged-in Sessions:	0

System Information			
OS version:		SunOS 5.9	
Description	Total(kb)	Used	Available
Root File System	22620522	2540265 (11%)	20080257 (89%)
Swap Space	4970800	16 (0%)	4970784 (100%)
/tmp	4970800	16 (0%)	4970784 (100%)

FIGURE 3-2 Summary Status Window

▼ To Change the Administrator's Password

The password allows you to use the Administration Tool to access and change Sun Ray administration data.

1. In the navigation menu, click the arrow to the left of **Admin** to view the options.
2. Click the **Password** link.

The Change Admin Password window is displayed.

Note – In failover groups, all servers must use the same password for the admin account.

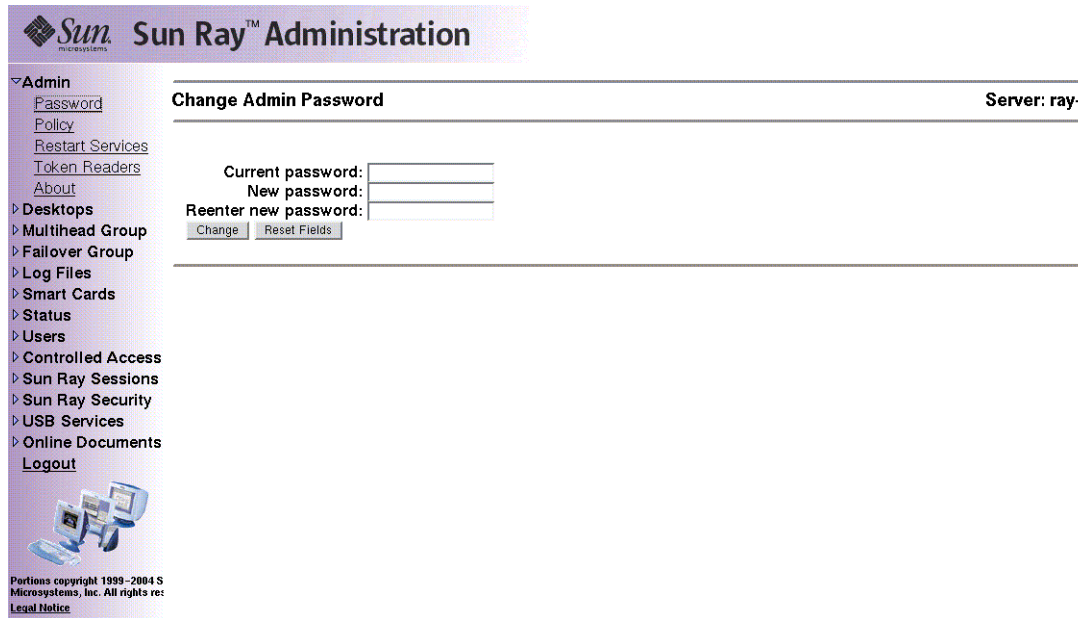

FIGURE 3-3 Change Admin Password Window

3. Enter your current password.
4. Enter a new password.
5. Re-enter the new password.

Tip – If you make a mistake, click the Reset Fields button to clear the fields and start again.

6. Click the Change button.

The new password takes effect and the internal database hierarchy is updated.

Changing Policies

Set the same policies on all the Sun Ray servers in a given failover group. If all the servers are configured to use the same policies and a failover occurs, all policies remain consistent.

Changes to local policies affect only the current Sun Ray server; changes to group policies affect all Sun Ray servers in the same group.

▼ To Change the Policy

1. Select the arrow to the left of **Admin** in the navigation bar to expand the menu.
2. Click the **Policy** link.

The Change Policy window is displayed.

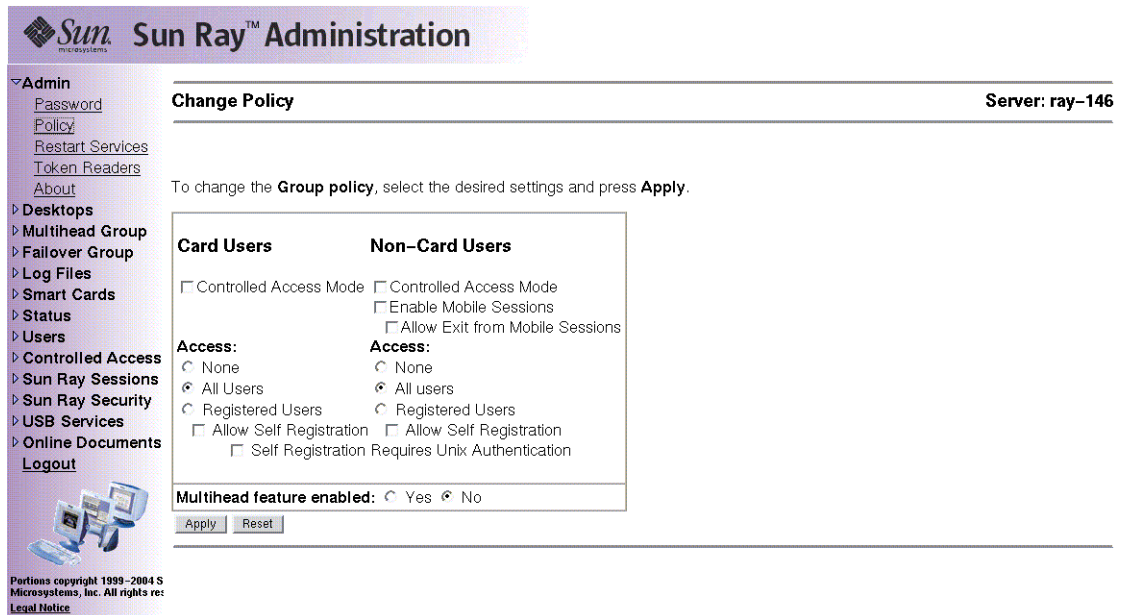

FIGURE 3-4 Change Policy Window

3. Under **Card Users**, select either **None**, **All Users**, or **Registered Users**.
4. Under **Non-Card Users**, select either **None**, **All Users**, or **Registered Users**.
Registered users are those you have registered. Allow Self Registration enables users to self-register when they insert their cards. All Users encompasses all types of users.
5. Select **Self Registration Requires Authentication**, if applicable.
6. To enable multihead, click the **Yes** radio button next to **Multihead feature enabled**.
7. Notify users to log off to avoid losing their sessions.

8. Restart services.

When changing the Multihead feature, you have the *option* of resetting Sun Ray services. All other changes *require* you to restart Sun Ray services.

Restarting Sun Ray Services

▼ To Preserve Sessions Upon Restart

1. From the expanded navigation menu under Admin, click the Restart Services link. The Sun Ray Services window is displayed.

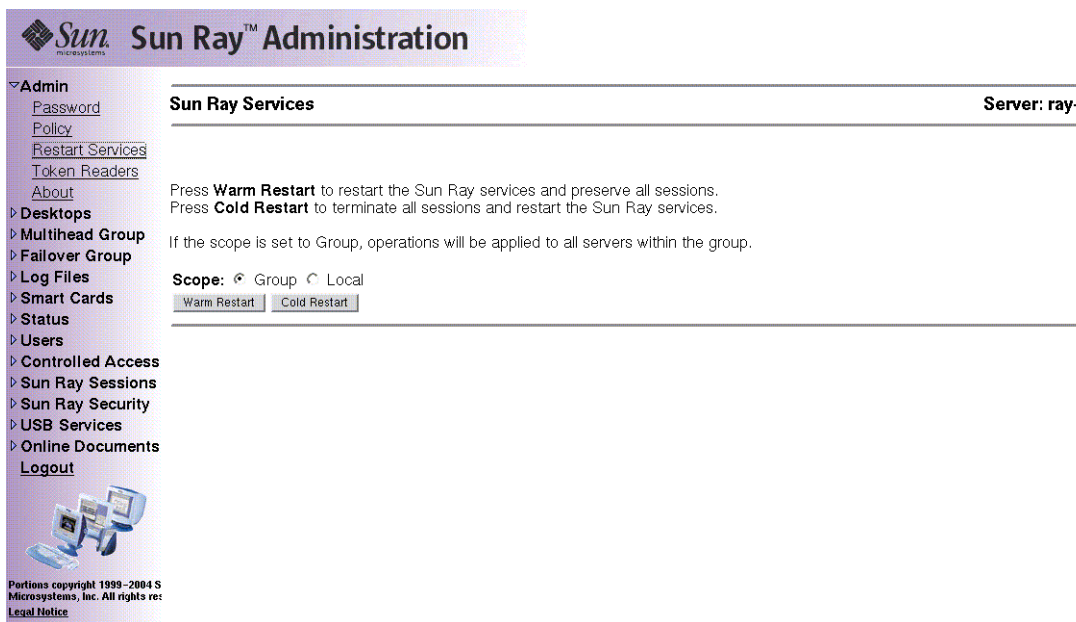

FIGURE 3-5 Sun Ray Services Window

2. Click Warm Restart.

Sun Ray services are reset, and the sessions are preserved.

Note – Warm Restart provides the same functionality as the Reset button in earlier versions of Sun Ray Server Software.

▼ To Terminate Sessions Upon Restart

- **Click Cold Restart.**

All sessions are immediately terminated, and Sun Ray services are restarted.

Note – In a failover group, you must initiate these functions from the primary server in the group.

Token Readers

You can use the Administration Tool to create token readers and locate Sun Ray DTUs designated as token readers. Sun Ray DTUs configured as token readers do not support hot desking. They display the token reader icon instead of a login dialog box.

Creating a Token Reader

A token reader is a Sun Ray DTU that reads a smart card and returns the card's ID. A valid ID allows you to add a user.

▼ To Create a Token Reader

1. **Click the arrow in front of Desktops to expand the navigation menu.**
2. **Click the View Current link.**

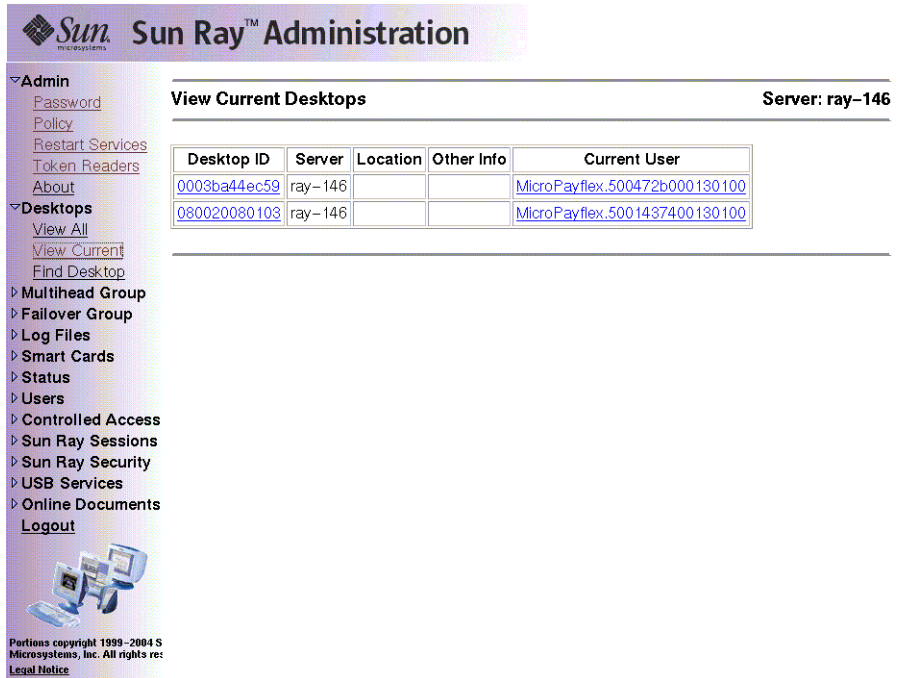

FIGURE 3-6 View Current Desktops Window

3. Select the desktop of the DTU you want to use as a token reader. The Current Properties window is displayed.

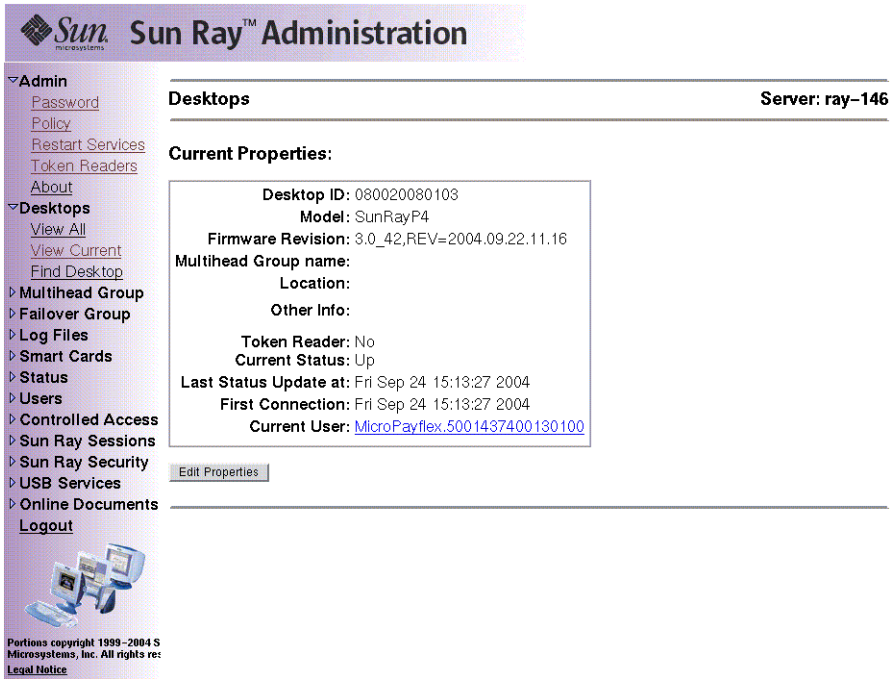

FIGURE 3-7 Current Properties Window

4. Click the **Edit Properties** button.

The Edit Desktop Properties window is displayed.

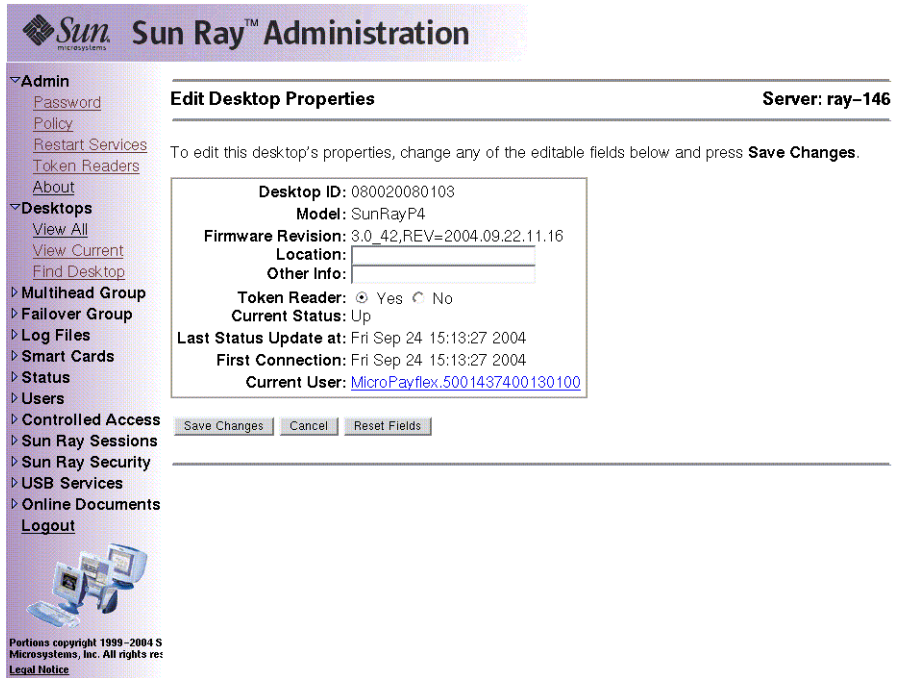

FIGURE 3-8 Edit Desktop Properties Window

5. Next to **Token Reader**, select the **Yes** radio button.

6. Click the **Save Changes** button.

The DTU you have selected is now set up to read smart cards.

7. **Restart Sun Ray services.**

The DTU is now a token reader.

▼ To Locate Token Readers

- From the expanded navigation menu under Admin, click the Token Readers link.

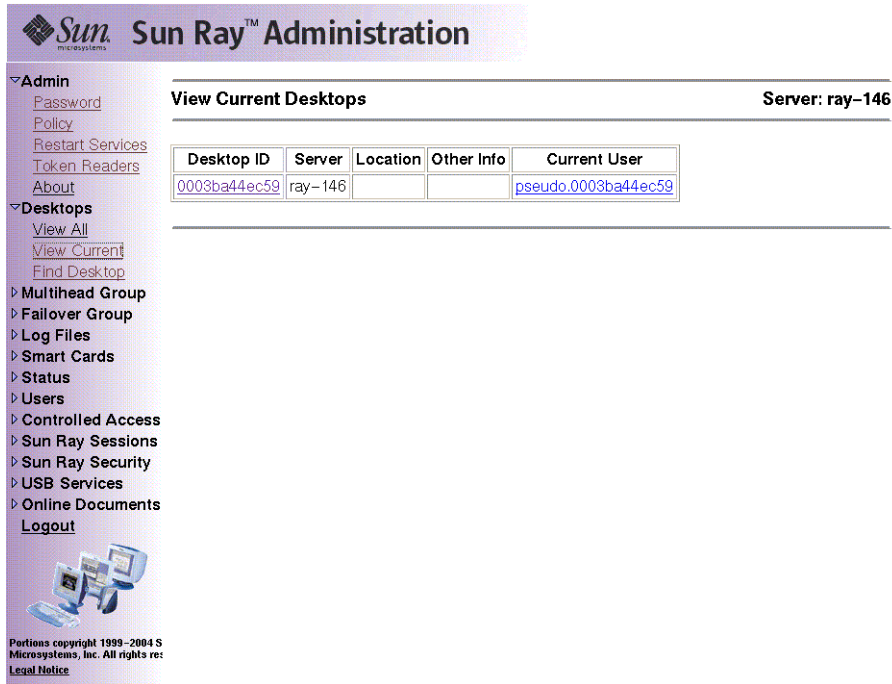

The screenshot displays the Sun Ray Administration web interface. The page title is "Sun Ray™ Administration". On the left is a navigation menu with sections for "Admin" (Password, Policy, Restart Services, Token Readers, About) and "Desktops" (View All, View Current, Find Desktop). The "View Current" link is selected. The main content area is titled "View Current Desktops" and shows "Server: ray-146". A table lists the current desktops:

Desktop ID	Server	Location	Other Info	Current User
0003ba44ec59	ray-146			pseudo.0003ba44ec59

At the bottom of the page, there is a copyright notice: "Portions copyright 1999-2004 S Microsystems, Inc. All rights reserved. Legal Notice".

FIGURE 3-9 Token Readers Window

▼ To Get Information on a Token Reader

- Click the Desktop ID link in the Token Readers window.

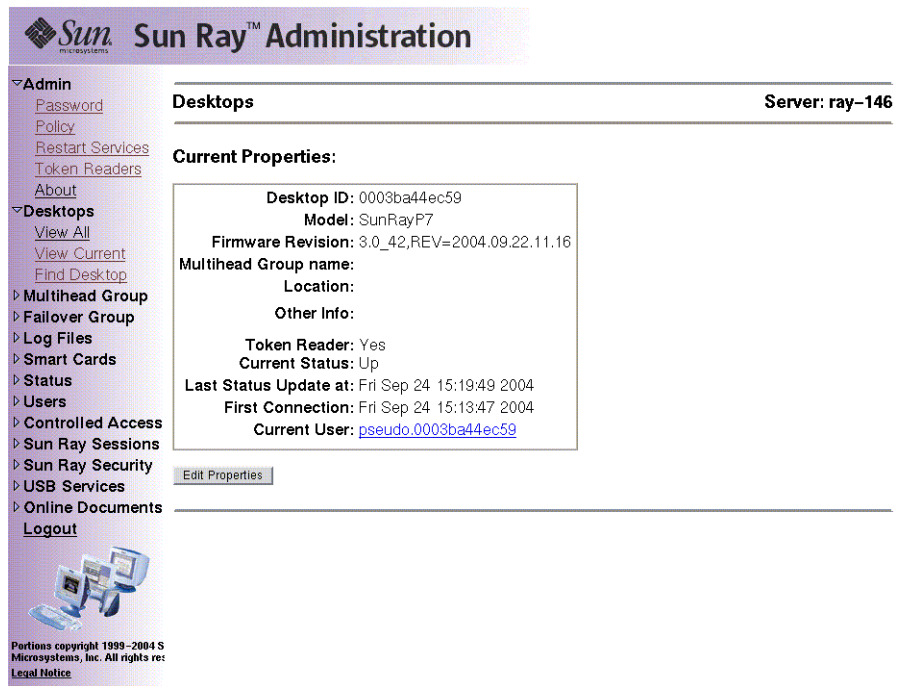

The screenshot shows the Sun Ray Administration web interface. The title bar reads "Sun Ray™ Administration". On the left is a navigation menu with categories: Admin (Password, Policy, Restart Services, Token Readers, About), Desktops (View All, View Current, Find Desktop), Multihead Group, Failover Group, Log Files, Smart Cards, Status, Users, Controlled Access, Sun Ray Sessions, Sun Ray Security, USB Services, and Online Documents. Below the menu is a "Logout" link and a small image of a computer workstation. At the bottom left of the page, it says "Portions copyright 1999-2004 S Microsystems, Inc. All rights reserved. Legal Notice".

The main content area is titled "Desktops" and shows "Server: ray-146". Under "Current Properties:", a box contains the following information:

- Desktop ID: 0003ba44ec59
- Model: SunRayP7
- Firmware Revision: 3.0_42,REV=2004.09.22.11.16
- Multihead Group name:
- Location:
- Other Info:
- Token Reader: Yes
- Current Status: Up
- Last Status Update at: Fri Sep 24 15:19:49 2004
- First Connection: Fri Sep 24 15:13:47 2004
- Current User: [pseudo.0003ba44ec59](#)

Below the box is an "Edit Properties" button.

FIGURE 3-10 Current Properties of a Token Reader

Managing Desktops

▼ To List All Desktops

1. In the navigation menu, click the directional arrow to the left of Desktops to view the options.
2. To view all desktops, click View All.

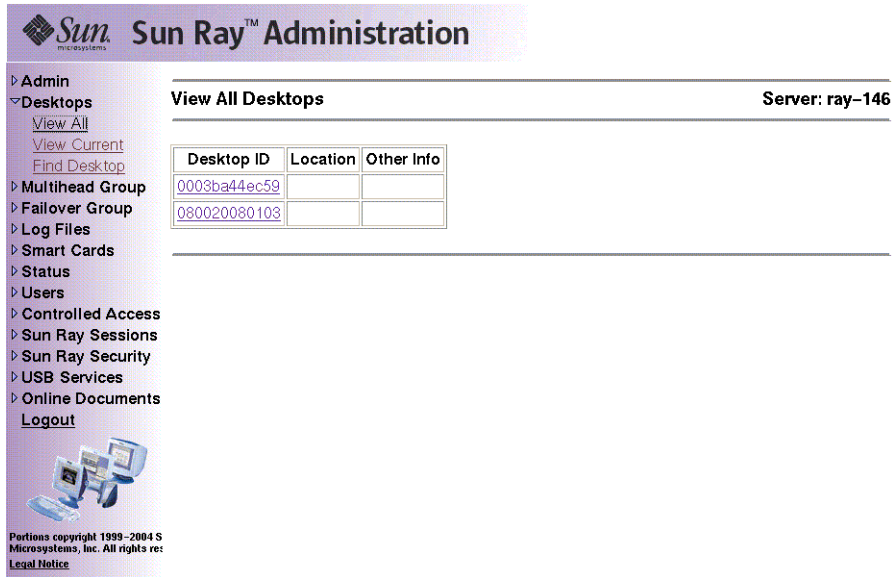

FIGURE 3-11 View All Desktops Window

▼ To Display a Desktop's Current Properties

- Click a Desktop ID link.

The Desktops Current Properties window is displayed (see FIGURE 3-7).

▼ To List Currently Connected Desktops

1. In the navigation menu, click the directional arrow to the left of Desktops to view the options.
2. Click View Current.

The View Current Desktops window is displayed (see FIGURE 3-6). This window lists the desktops that are currently connected to this Sun Ray server and communicating with the Authentication Manager or with any other Sun Ray server in the same failover group.

▼ To View the Properties of the Current User

- **From either the View Current User window or the Desktops Current Properties window, click the link for Current User.**

The Properties window for the Current User is displayed.

▼ To Search for Desktops

1. In the navigation menu, click the directional arrow to the left of Desktops to view the options.
2. Click Find desktop.

The Find Desktop window is displayed.

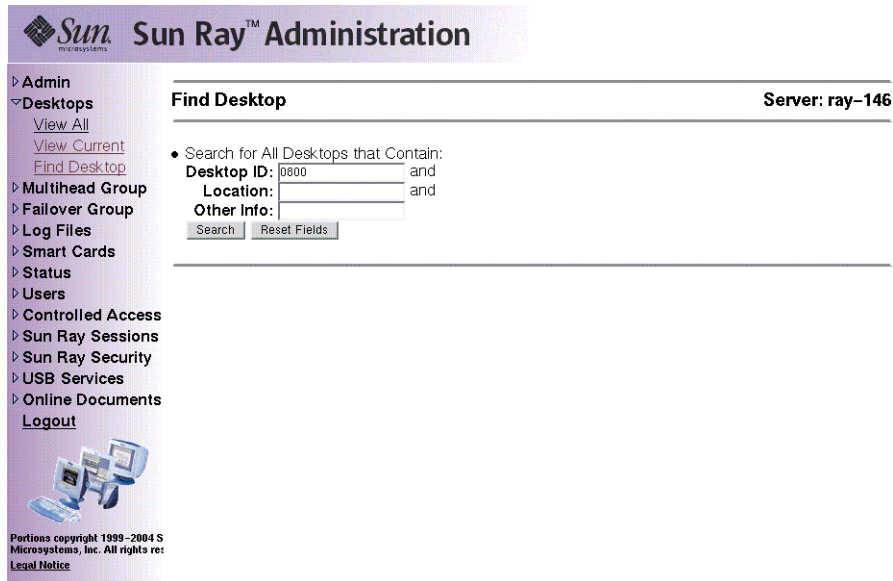

FIGURE 3-12 Find Desktop Window

3. From the Find Desktop page, enter data into the Desktop ID, Location, and Other Info fields.

4. Click the Search button.

The Find Desktop window is redisplayed with all matches in the administration database.

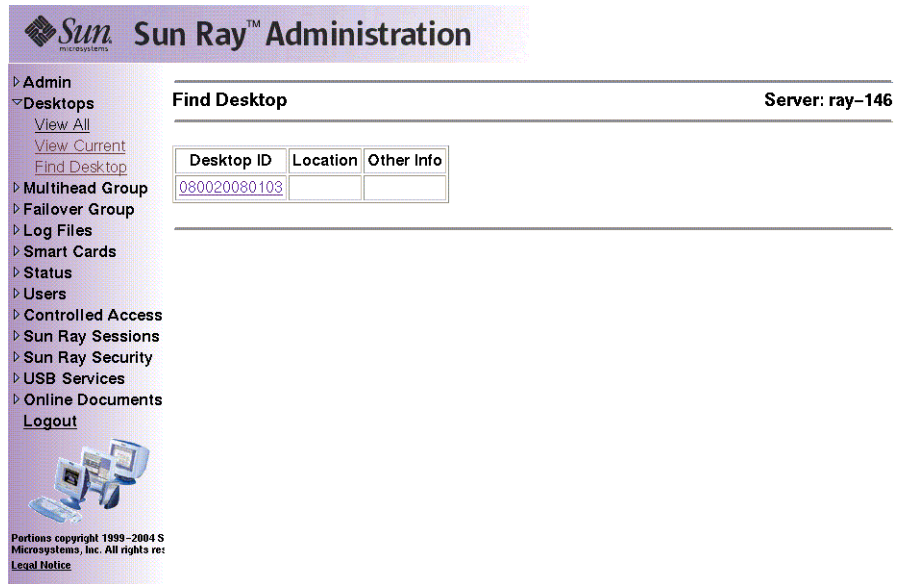

FIGURE 3-13 Find Desktop Search Results Window

▼ To Edit a Single Desktop's Properties

- 1. To display the Desktop Properties page for the desktop you want to edit, click the Desktop ID.**

The Desktops Current Properties window is displayed (see FIGURE 3-7).

- 2. Click the Edit Properties button.**

The Edit Desktop Properties window is displayed (see FIGURE 3-8).

- 3. Change the data in the text boxes as appropriate.**
- 4. Click the Save Changes button to save the changes to the administration database.**

Sun Ray DTU Settings

Sun Ray Settings is an interactive GUI that allows the user to view and change the settings for the Sun Ray DTU that the user is currently logged into.

The Sun Ray Settings GUI contacts the Session Manager to determine which DTU is currently being used and connects to that unit to get the current values. The GUI maintains a connection to the Session Manager so that the Session Manager can notify the GUI if the user moves to another DTU by removing the smart card and inserting it into another DTU.

▼ To Change the Sun Ray Settings

1. **Press the hot key (by default Shift-Props).**

The Sun Ray Settings window is displayed.

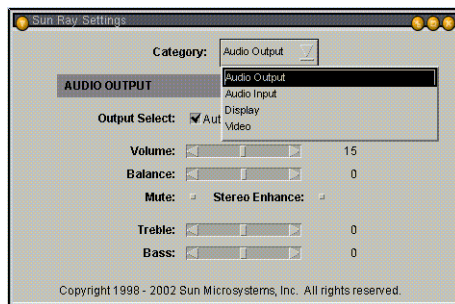

FIGURE 3-14 Settings Screen

2. **Use the Category pull-down menu to access Audio Output, Audio Input, Display, and Video settings.**
3. **To change a setting, move the appropriate scroll bar, checkbox, or pull-down menu.**

The DTU is updated immediately.

The only exception is the “Resolution/Refresh Rate” setting, which prompts the user with confirmation dialog boxes before and after the change is made on the DTU.

4. **Press the hot key to close the window.**

Note – Only one instance per session of Sun Ray Settings runs in hot key mode.

Managing Multihead Groups

The multihead feature allows users to control separate applications on multiple Sun Ray screens. Only a single keyboard and pointer device, attached to the primary DTU, are needed. The multihead feature also allows users to display and control a single application, such as a spreadsheet, on multiple screens.

System administrators create multihead groups so that users can access them. A multihead group, consisting of two or more DTUs controlled by one keyboard and mouse, can consist of Sun Ray 1, Sun Ray 100, Sun Ray 150, and Sun Ray 160 DTUs.

For further information on multihead implementations, see Chapter 9.

▼ To View All Multihead Groups

1. From the navigation menu, select the arrow to the left of **Multihead Group** to expand the menu.
2. Click the **View All** link.

The Multihead Groups window is displayed.

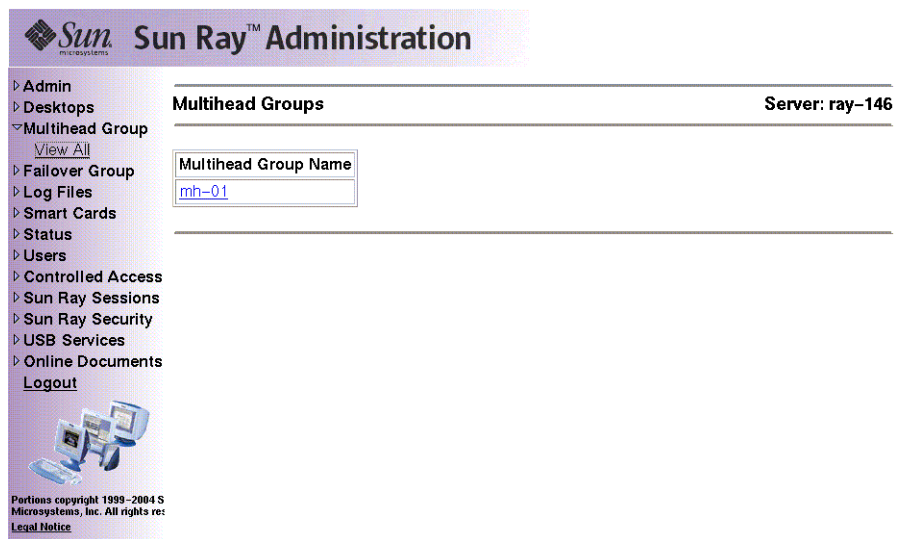

FIGURE 3-15 The Multihead Groups Window

3. To view the properties for this group, click the Multihead Group Name link. The Multihead Group Properties window is displayed.

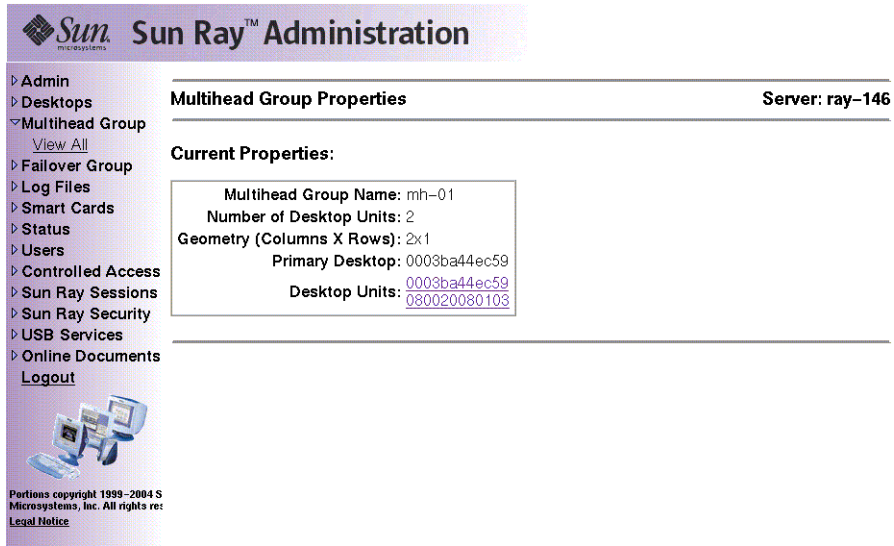
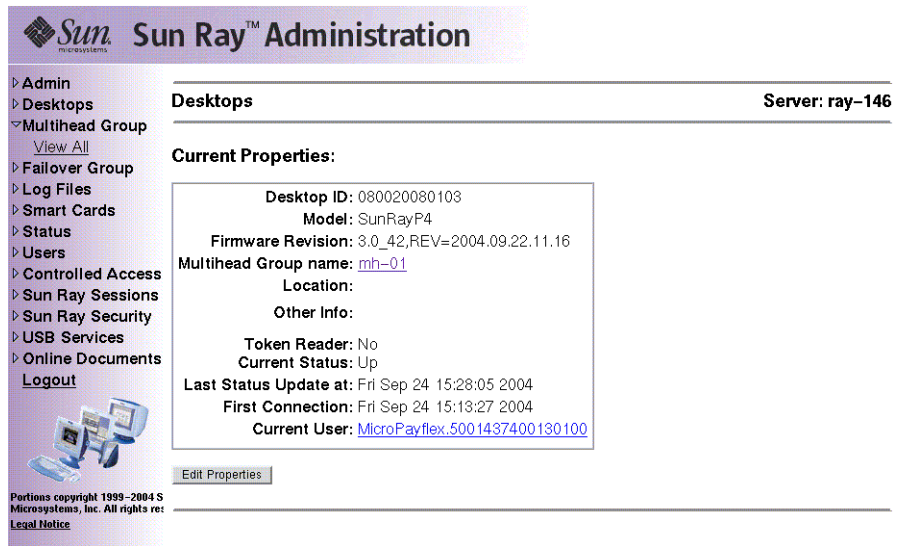

FIGURE 3-16 The Multihead Group Properties Window

4. To display the Desktops Current Properties for the DTUs that are part of this group, click the Desktop Units links.

The Desktops Current Properties window for the link selected is displayed.



The screenshot shows the Sun Ray Administration web interface. The title bar reads "Sun Ray™ Administration". On the left is a navigation menu with items like Admin, Desktops, Multihead Group, Failover Group, Log Files, Smart Cards, Status, Users, Controlled Access, Sun Ray Sessions, Sun Ray Security, USB Services, Online Documents, and Logout. The main content area is titled "Desktops" and "Server: ray-146". Below this is a "Current Properties:" section containing a box with the following information:

- Desktop ID: 080020080103
- Model: SunRayP4
- Firmware Revision: 3.0_42,REV=2004.09.22.11.16
- Multihead Group name: [mh-01](#)
- Location:
- Other Info:
- Token Reader: No
- Current Status: Up
- Last Status Update at: Fri Sep 24 15:28:05 2004
- First Connection: Fri Sep 24 15:13:27 2004
- Current User: [MicroPayflex.5001437400130100](#)

Below the box is an "Edit Properties" button. At the bottom left, there is a copyright notice: "Portions copyright 1999-2004 Sun Microsystems, Inc. All rights reserved. Legal Notice".

FIGURE 3-17 Desktops Current Properties Window

The Multihead Group name is displayed as a property of this desktop.

Managing USB Services

All USB device access is enabled by default. To disable USB devices, the administrator must explicitly use the GUI, as shown in this section, or the `utusbadm` command, which is described under “Enabling and Disabling USB Devices” on page 22.

Use the following procedure to change the state of USB device access:

▼ To Enable or Disable USB Device Access

1. From the navigation menu, select the arrow to the left of the USB Services in the navigation bar to expand the menu.
2. Click on USB Services in the menu to display the USB Service window.

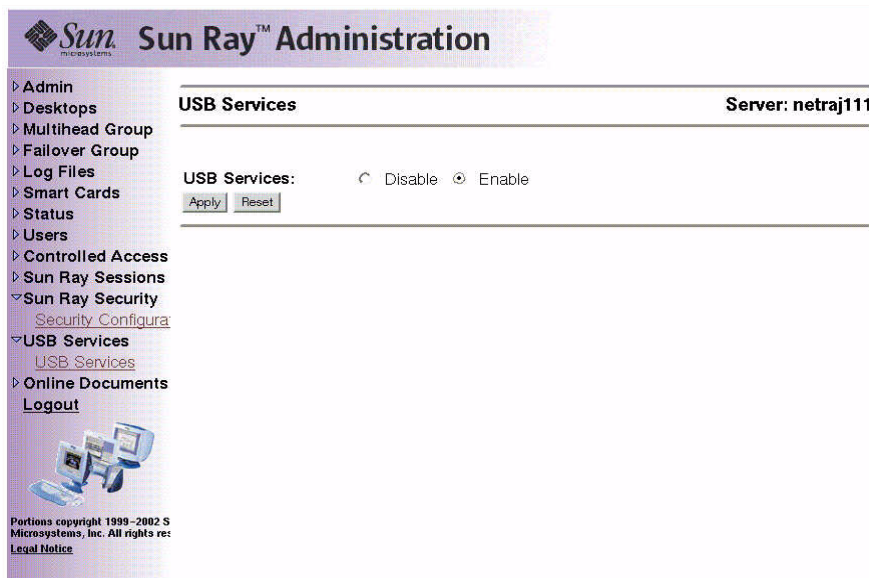

FIGURE 3-18 USB Services Window

3. Toggle the Disable or Enable radio button.
4. Click Apply to make the relevant change.

SunRay services must be restarted before these changes can take effect.

Examining Log Files

Significant activity concerning files retrieved from the Sun Ray server is logged and saved. The server stores this information in text files. TABLE 3-1 describes the log files that are maintained.

TABLE 3-1 Log Files

Log File	Path	Description
Administration	<code>/var/opt/SUNWut/log/admin_log</code>	Lists operations performed during server administration. This log is updated daily. Archived files are stored on the system for up to one week and are annotated using numeric extensions (for example, from filename <code>admin_log.0</code> to <code>admin_log.5</code>).
Authentication	<code>/var/opt/SUNWut/log/auth_log</code>	Lists events logged from the Authentication Manager. The <code>auth_log</code> file is updated (up to a limit of 10) every time the server's authentication policy is changed or started. The archived authentication files are annotated using numeric extensions (for example, from <code>auth_log.0</code> to <code>auth_log.9</code>).
Automatic Mounting	<code>/var/opt/SUNWut/log/utmountd.log</code>	Lists mount messages for mass storage devices. The archived <code>mountd</code> files are annotated using numeric extensions (for example, from <code>utmountd.log.0</code> to <code>utmountd.log.9</code>).
Mass Storage Devices	<code>/var/opt/SUNWut/log/utstoraged.log</code>	Lists mass storage device events. The archived storage files are annotated using numeric extensions (for example, from <code>utstoraged.log.0</code> to <code>utstoraged.log.9</code>).
Messages	<code>/var/opt/SUNWut/log/messages</code>	Lists events from the server's DTUs, including details of registering, inserting, or removing smart cards. This file is updated daily. Archived files are stored on the server for one week annotated with numeric extensions (for example, from <code>messages.0</code> to <code>messages.5</code>).

▼ To View a Log File

1. From the navigation menu, select the arrow to the left of Log Files to expand the menu.
2. Choose the Log link you want to inspect: Messages, Auth Log, Admin Log, Archived Logs, utmountd.log, or utstored.log.

The appropriate Log File window is displayed. Use the scroll bar to access data to the right and bottom of the window.

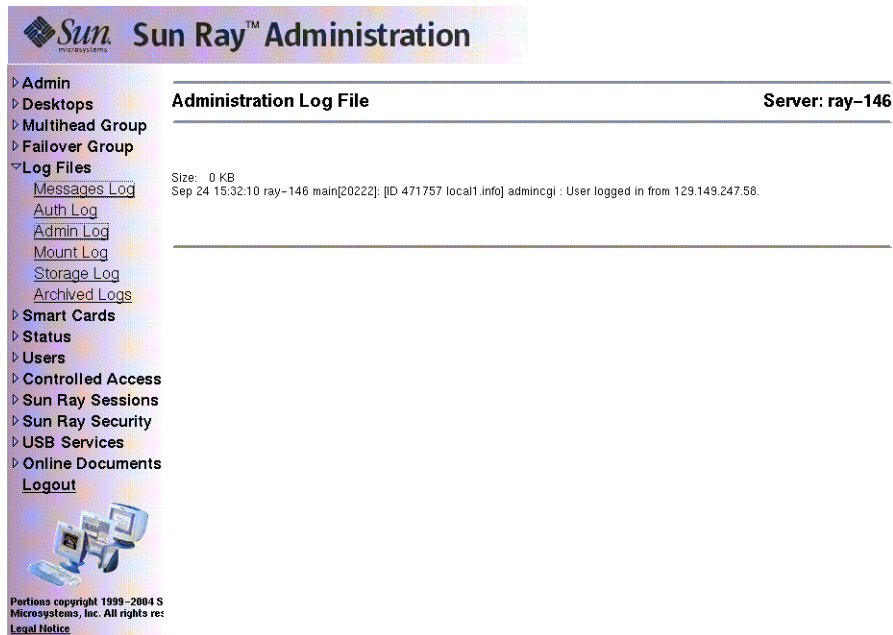

FIGURE 3-19 Administration Log File Window

Managing Smart Cards

The information provided about smart cards is extracted from vendor-supplied configuration files. These configuration files are located in the directory: `/etc/opt/SUNWut/smartcard`. Configuration files must be formatted correctly, and file names must end with a `.cfg` suffix; for example, `acme_card.cfg`.

For certain vendors, the smart card may require additional software to enable the Sun Ray Server Software to probe for it. If required, this optional software must be supplied as Java classes in a Jar file. This file must end with a .jar suffix and must have the same pre-suffix filename as the .cfg file that contains its configuration information.

▼ To View or List Configured Smart Cards

1. From the navigation menu, select the arrow to the left of Smart Cards to extend the menu.
2. Click the View link.

The View Configured Smart Cards window is displayed. Smart cards are listed in probe order, i.e., the order in which they are inspected.

Sun Ray™ Administration Server: ray-146

View Configured Smart Cards

Smart Card	Version	Supplier
ActivCard-Gold	1.0	Sun Microsystems, Inc.
GD-SMARTCAFE	1.0	Sun Microsystems, Inc.
JavaBadge-Citibank	1.0	Sun Microsystems, Inc.

Portions copyright 1999-2004 S
Microsystems, Inc. All rights reserved.
Legal Notice

FIGURE 3-20 The View Configured Smart Cards Window

From this window an administrator can see the current list of smart cards as well as the supplier and version number for each card.

3. From the View Configured Smart Cards window, select the link for the smart card.
The main properties for the selected smart card are displayed in FIGURE 3-21.

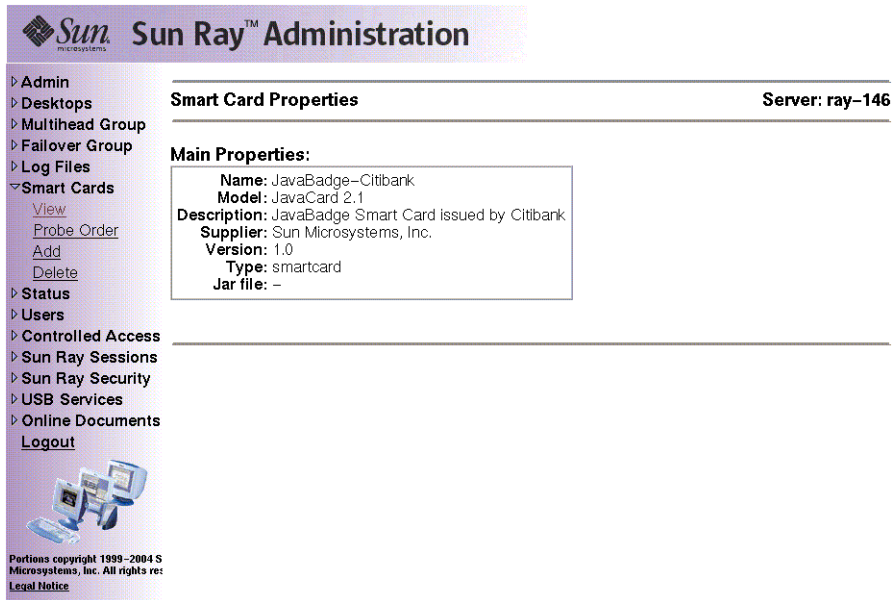

FIGURE 3-21 Smart Card Properties Window

▼ To View The Smart Card Probe Order

- From the navigation menu under Smart Cards, click the Probe Order link. The Smart Card Probe Order window is displayed.

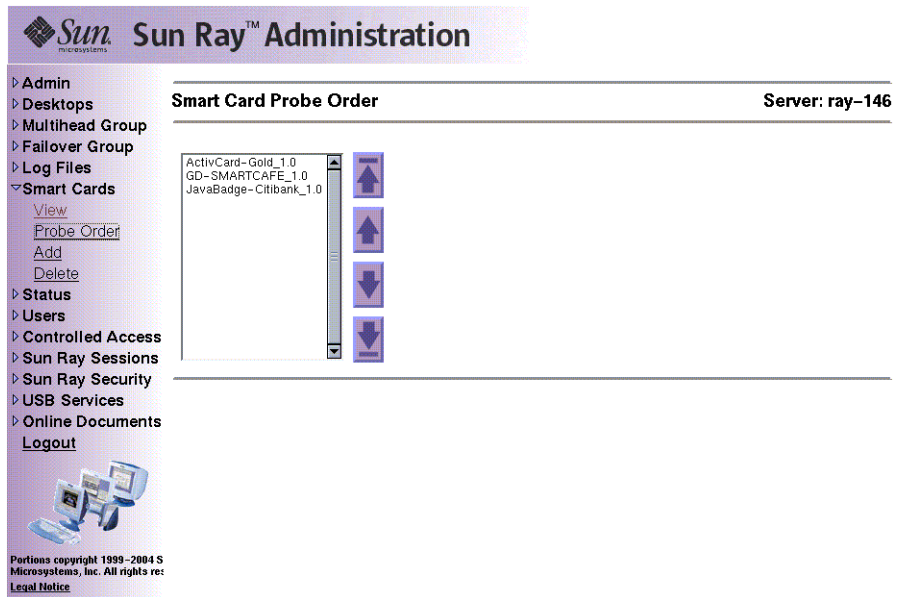

FIGURE 3-22 Smart Card Probe Order Window

Smart cards are probed in the order in which they appear in this list.

Tip – As you add more cards, you can change the order of the cards to move those used most often to the top of the list.

▼ To Change the Smart Card Probe Order

- Select a smart card and press the appropriate up and down button. Clicking on the first and last buttons (from top to bottom) moves the selected card to either the top or bottom of the list.

▼ To Add a Smart Card

1. From the expanded navigation menu under Smart Cards click the Add link.
The Add Smart Cards to Probe List window is displayed.

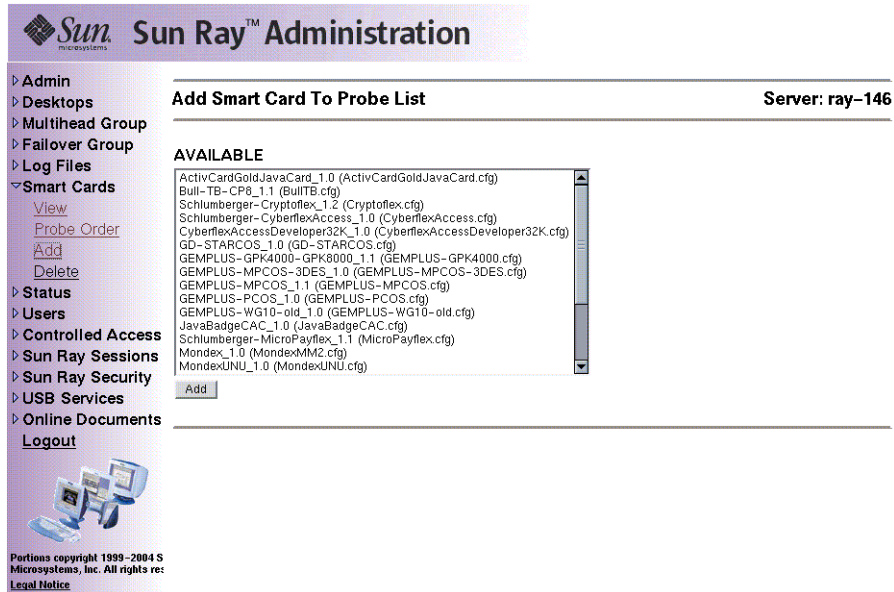

FIGURE 3-23 Add Smart Card to Probe List Window

2. Select a smart card and click the Add button.

▼ To Delete a Smart Card

1. From the expanded navigation menu under Smart Cards, click the Delete link.
The Delete Smart Card From Probe List window is displayed.
2. Select a smart card.
3. Click the Delete button.

Sun Ray System Status

▼ To View the Sun Ray System Status

1. Click the directional arrow to the left of Status to expand the navigation menu.
2. Click the Summary Status link.

The Summary Status window is displayed.

Sun Ray Administration Server: ray-146

Summary Status

Sun Ray Information	
Sun Ray Server Software Version:	3.0
Failover Group Role:	Primary
Desktops Connected:	2
Total Sessions:	2
Logged-In Sessions:	0

System Information			
OS version:		SunOS 5.9	
Description	Total(kb)	Used	Available
Root File System	22620522	2540651 (11%)	20079871 (89%)
Swap Space	4908136	144 (0%)	4907992 (100%)
/tmp	4908136	144 (0%)	4907992 (100%)

Refresh

FIGURE 3-24 Summary Status Window

Administering Users

You can specify the following user fields in the Sun Ray administration database:

TABLE 3-2 Key User Fields

Field	Description
Token ID	User's unique token type and ID. For smart cards, this is a manufacturer type and the card's serial ID. For DTUs, this is the type "pseudo" and the DTU's Ethernet address. Examples: mondex.9998007668077709 pseudo.080020861234
Server Name	Name of the Sun Ray server that the user is using.
Server Port	Sun Ray server's communication port. This field should generally be set to 7007.
User Name	User's name.
Other Info	Any additional information you want to associate with the user (for example, an employee or department number). This field is optional.

▼ To View Users by ID

- From the expanded Users navigation menu, click the View by ID link.

The View Users by ID window is displayed. The list of all the users in the administration database is sorted by the Token ID field. If a user has multiple tokens, they are listed separately.

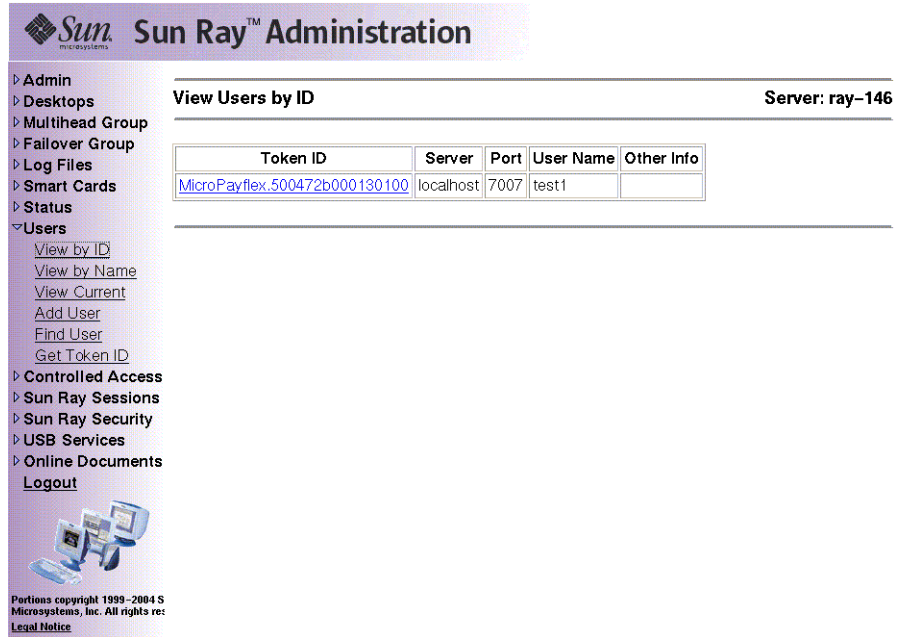

The screenshot shows the Sun Ray Administration interface. The title bar reads "Sun Ray™ Administration". On the left is a navigation menu with categories like Admin, Desktops, Multihead Group, Failover Group, Log Files, Smart Cards, Status, Users, Controlled Access, Sun Ray Sessions, Sun Ray Security, USB Services, Online Documents, and Logout. The "Users" category is expanded, showing options: View by ID, View by Name, View Current, Add User, Find User, and Get Token ID. The main content area is titled "View Users by ID" and indicates "Server: ray-146". It contains a table with the following data:

Token ID	Server	Port	User Name	Other Info
MicroPayflex.500472b000130100	localhost	7007	test1	

At the bottom of the window, there is a copyright notice: "Portions copyright 1999-2004 S Microsystems, Inc. All rights reserved. Legal Notice".

FIGURE 3-25 View Users by ID Window

▼ To View Users by Name

- From the expanded Users navigation menu, click the View by Name link.

The View Users by Name window is displayed, listing all the users in the administration database sorted by the User Name field. If a user has multiple tokens, they are grouped together with the name.

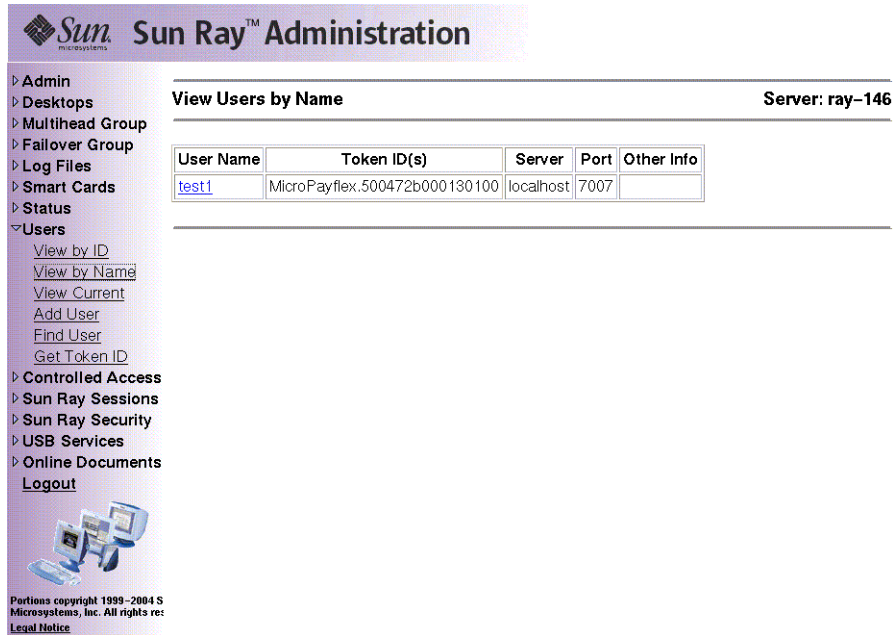

Sun Ray™ Administration

Server: ray-146

User Name	Token ID(s)	Server	Port	Other Info
test1	MicroPayflex.500472b000130100	localhost	7007	

Portions copyright 1999-2004 S
Microsystems, Inc. All rights reserved.
[Legal Notice](#)

FIGURE 3-26 View Users by Name Window

▼ To Delete a User

Caution – This operation deletes the user and all associated tokens.

1. From the View by Name window, click the User Name of the user you want to delete.

The Current Properties window displays information about the user, host, token, and allows the administrator to edit the user's properties, delete the user, and view the user's session.

The screenshot shows the Sun Ray Administration web interface. The title bar reads "Sun Ray Administration" with the Sun Microsystems logo. A left-hand navigation menu includes: Admin, Desktops, Multihead Group, Failover Group, Log Files, Smart Cards, Status, Users (expanded), Controlled Access, Sun Ray Sessions, Sun Ray Security, USB Services, and Online Documents. Under "Users", options include "View by ID", "View by Name", "View Current", "Add User", "Find User", and "Get Token ID". The "View Current" option is selected, displaying the "Current Properties" window for user "test1" on server "ray-146".

Current Properties:

User Name: test1
Other Info:
Server Name: localhost
Server Port: 7007
User Created: Fri Sep 24 17:21:00 2004

Token ID	Enabled?
MicroPayflex.5001437400130100	Yes

Currently Logged In:

Current Desktop: [080020080103](#)
Desktop Location:
Logged In Since: Fri Sep 24 17:21:06 2004

Buttons: Edit Properties | Delete This User | View This User's Session

Partitions copyright 1999-2004 S
Microsystems, Inc. All rights reserved.
[Legal Notice](#)

FIGURE 3-27 The Current Properties Window Shows Administrative Options for a User

2. Press the Delete This User button.

The Delete User page is displayed.

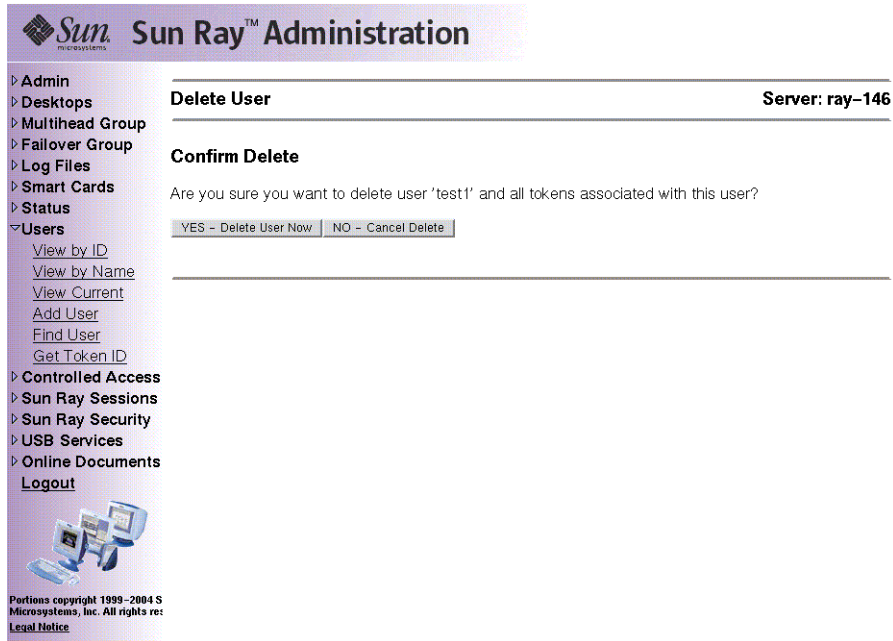

FIGURE 3-28 Delete User Window

3. To delete the user, press the YES — Delete User Now button.

To cancel this delete operation, press the NO — Cancel Delete button. If you press YES, the user and all associated tokens are deleted from the administration database and a confirmation of your delete operation is displayed. If you press NO, you are returned to the Current Properties page.

▼ To View Current Users

- From the expanded navigation menu under Users, click the View Current link. The View Current Users window is displayed, listing users who currently have active sessions.

Note – The list of users conforms to policies established with `utpolicy`, with which you can enable display of registered users, unregistered users, or both.

Token ID	User Name	Server	Desktop ID	Desktop Location
MicroPayflex.5001437400130100	???	ray-146	080020080103	???
pseudo_0003ba44ec59	???	ray-146	0003ba44ec59	???

FIGURE 3-29 View Current Users Window

▼ To Display a User's Current Properties

- Click the Token ID or User Name hyperlink for the user. The Current Properties page for the user is displayed (see FIGURE 3-27). It displays the information about the user contained in the administration database, including the user's current login status.

The possible states are:

- Never Logged In
- Currently Logged In

■ Logged Off

For the last two states, the following fields are also displayed:

TABLE 3-3 Login Status Fields

Option	Description
Current Desktop/Last Desktop	Current/last DTU where the user is or was logged in.
Desktop Location	Location of the DTU.
Logged In Since/Logged Off At Date	At Date and time the user logged in or off the DTU.

▼ To Add a User

1. From the expanded menu under Users, click the Add User link.

The Add User window is displayed.

Sun Ray™ Administration

Add User Server: ray-146

To add a user, insert the user's token in the desired reader and press **Get Token ID** to fill in the Token ID field below. Then fill out the rest of the fields and press **Add User**.

Token Reader: 0003ba44ec59

Token ID:
Server Name: localhost
Server Port: 7007
User Name:
Other Info:

FIGURE 3-30 Add User Window

2. If you do not know the user's Token ID and have configured a token reader:
 - a. Insert the user's new card into the selected token reader.

b. Choose the selected token reader from the pull-down menu of available readers.

c. Press the Get Token ID button.

The application queries the token reader and, if successful, redisplay the form with the Token ID field filled out.

3. Enter data in the required fields.

4. Press the Add User button.

The user and associated token are created in the administration database.

▼ To View the User's Sessions

- **If the user is currently logged in, you can view the user's session by clicking the View This User's Session button.**

▼ To Edit a User's Properties

1. From the user's Current Properties page, press the Edit Properties button. The Edit User Properties page is displayed.

Sun Ray™ Administration Server: ray-146

Edit User Properties

To add a Token ID to this user, select a token reader and press **Get Token ID** below to fill in the new token ID field. Then, make any other changes and press **Save Changes**.

User Name: test1
Other Info:
Server Name: localhost
Server Port: 7007
User Created: Fri Sep 24 15:51:40 2004

Token ID	Enabled?	
MicroPayflex.500472b000130100	<input checked="" type="checkbox"/>	<input type="checkbox"/> Remove
<input type="text"/>	<input type="checkbox"/>	<input type="checkbox"/> Add

Token Reader: 0003ba44ec59

Portions copyright 1999-2004 S
Microsystems, Inc. All rights reserved.
Legal Notice

FIGURE 3-31 Edit User Properties Page

2. Make changes to any of the text boxes.
You can also add or remove tokens from a user at the same time.
 3. When finished, press the Save Changes button.
The changes are saved to the administration database.
- ## ▼ To Add a Token ID to a User's Properties
1. From the Edit User Properties page, type the new Token ID into the empty Token ID text field.
 2. If you do not know the new Token ID and have configured a token reader:
 - a. Insert the user's new card into the selected token reader.

b. Choose the selected token reader from the pull-down menu of available readers.

c. Press the Get Token ID button.

The application queries the token reader and, if successful, redisplay the form with the Token ID text field filled out.

3. Check the Enabled checkbox next to the new Token ID.

4. Check the Add checkbox next to the new Token ID.

You can also make any other edits to the user at the same time.

5. Press the Save Changes button.

The changes are then added to the administration database.

▼ To Delete a Token ID From a User's Properties

1. From the Edit User Properties page, check the Remove checkbox for any token IDs you want to remove.

2. Press the Save Changes button.

The changes are then added to the administration database.

▼ To Enable or Disable a User's Token

1. From the Edit User Properties page, check the Enabled checkbox for any token IDs you want to enable.

2. Uncheck the Enabled checkbox for any token IDs you want to disable.

3. Press the Save Changes button.

The changes are saved to the administration database.

▼ To Find a User

1. From the expanded menu under Users, click the Find link.

The Find User window is displayed.

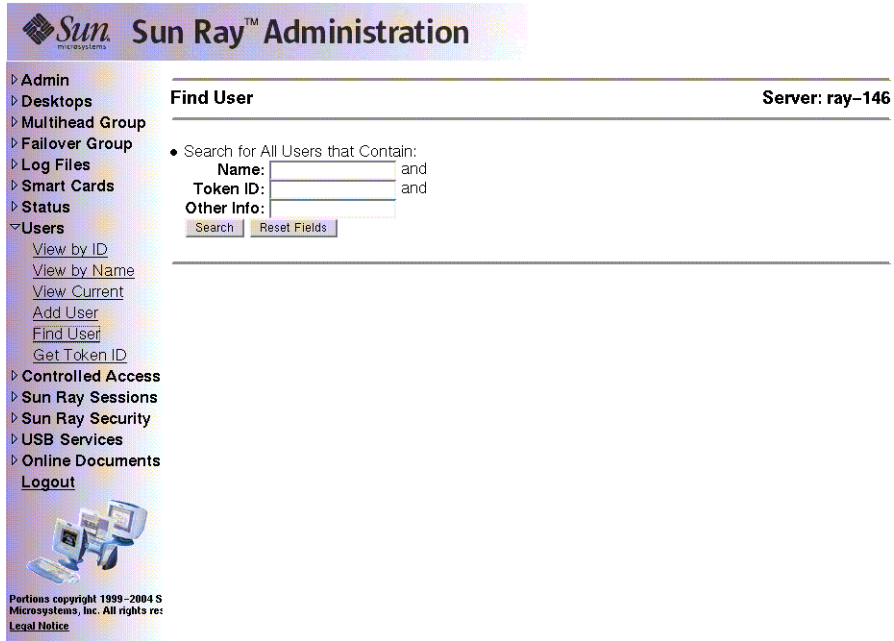

FIGURE 3-32 Find User Window

2. Enter data in the required fields.
3. Press the Search button.

▼ To Get a Token ID From a Token Reader

1. From the expanded **Users** menu, click the **Get Token ID** link.

The Get Token ID window is displayed.

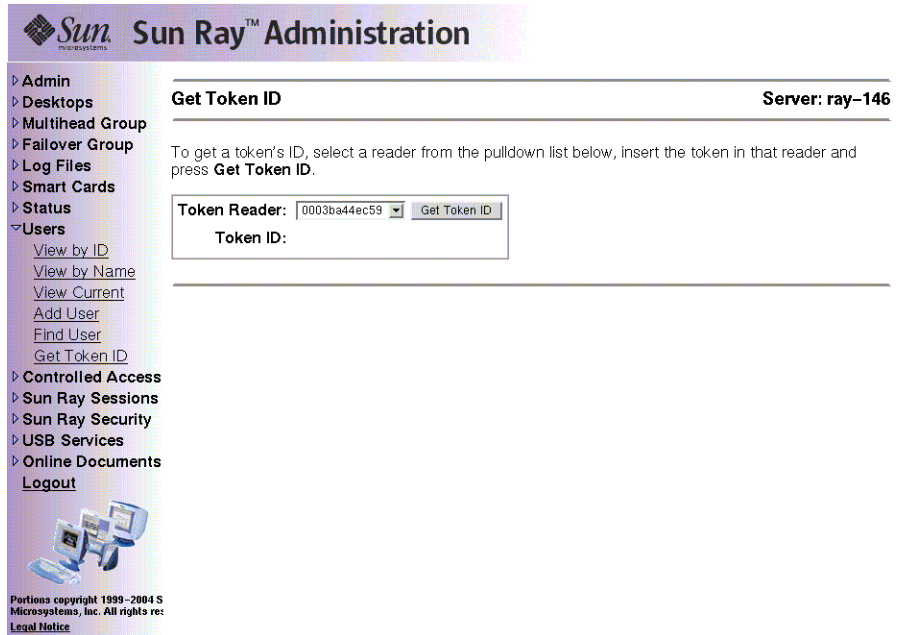

FIGURE 3-33 Get Token ID Window

2. Insert the new card into the selected token reader.
3. Choose the selected token reader from the pull-down menu of available readers.
4. Press the **Get Token ID** button.

The application queries the token reader and redisplay the page with the Token ID field filled out.

Controlled Access Mode

▼ To Configure Controlled Access Mode

1. Select the arrow to the left of Controlled Access Mode to expand the navigation menu.
2. Click the Settings link.

The Controlled Access Mode Configuration Window is displayed.

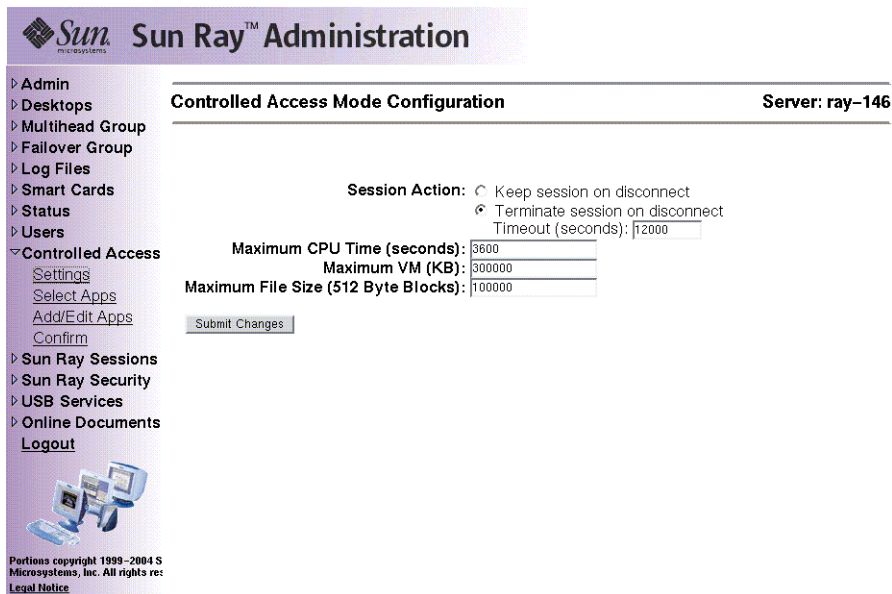

FIGURE 3-34 Controlled Access Mode Configuration Window

If the administrator selects the Terminate session upon removal of card option, the length of session timeout, in seconds, is displayed.

3. Click the Submit Changes button.

Use the link in the navigation bar to confirm before activating any changes.

▼ To Select Additional Applications

1. Select the arrow to the left of **Controlled Access Mode** to expand the navigation menu.
2. Click the **Select Applications** link.

The Select Additional Applications Window is displayed.

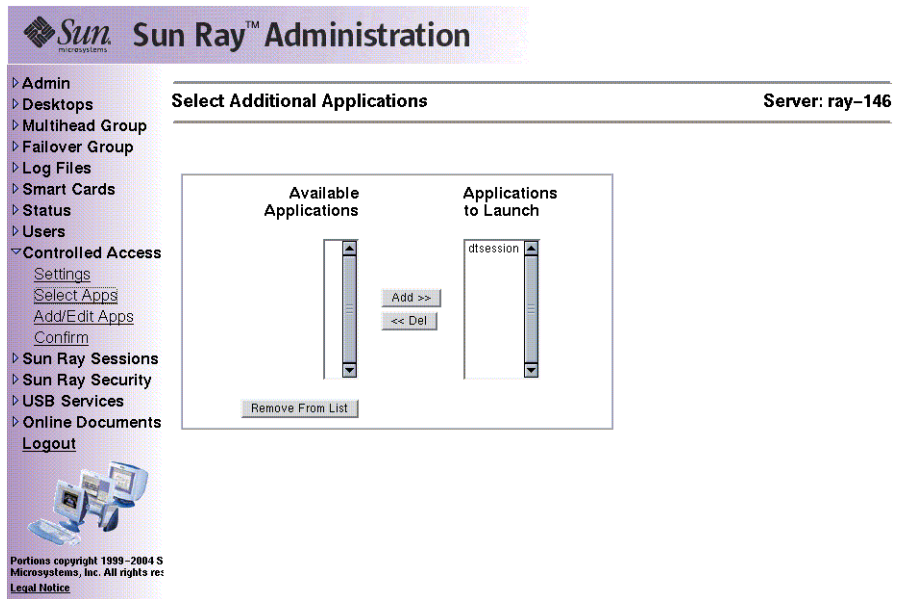

FIGURE 3-35 Select Additional Applications Window

From this window the administrator can configure browser behavior, home page, and proxy to work in Controlled Access Mode.

3. Highlight the applications in the **Available Applications** scroll box.
4. Click the **Add** button.
The application moves to the Applications to Launch scroll box. To be executable, an application must be in the Applications to Launch box.
5. To delete an application, follow this process in reverse by selecting an application in the **Applications to Launch** scroll box and clicking the **Del** button.
The application moves to the Available Applications scroll box.
6. To remove an application from the list of available applications, click the **Remove From List** button.
7. Click the **Confirm** link.

▼ To Add or Edit Applications

1. Expand the **Controlled Access Mode** menu and click the **Add/Edit Applications** link.

The Add/Edit Apps Window is displayed.

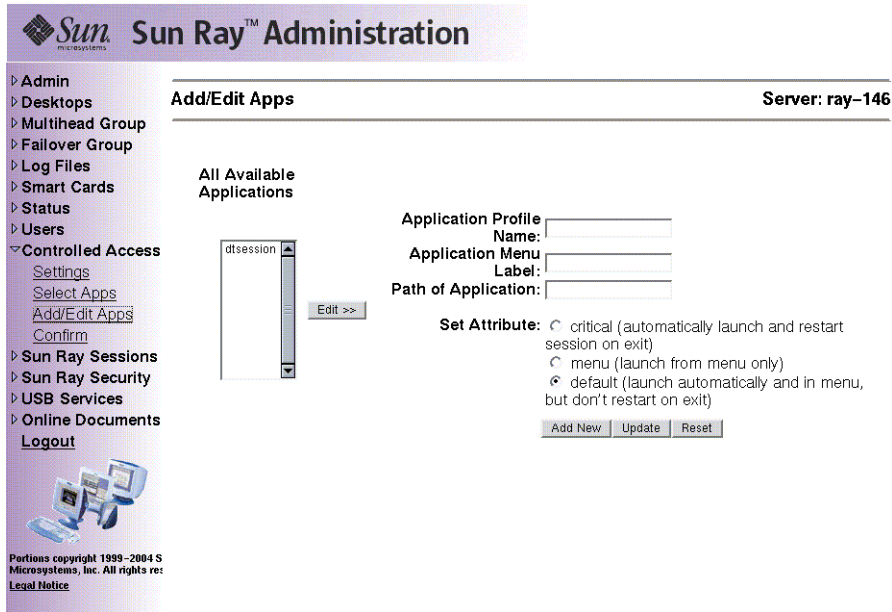

FIGURE 3-36 Add/Edit Apps Window

Applications can be edited or added from this window.

Note – If you are adding a new application, the Reset button clears the fields. If you are updating an existing application, the Reset button resets the fields to the original configuration.

2. To edit an application, highlight the application in the **All Available Applications** scroll box.
3. Click the **Edit** button.
The information for the application is displayed in the text fields.
4. When you have edited the text fields and selected the radio button for your preferred launch attribute, click the **Update** button.
5. To add an application, fill in the text fields and click the **Add New** button.

- Click **Confirm** in the expanded navigation menu under **Controlled Access Mode**.

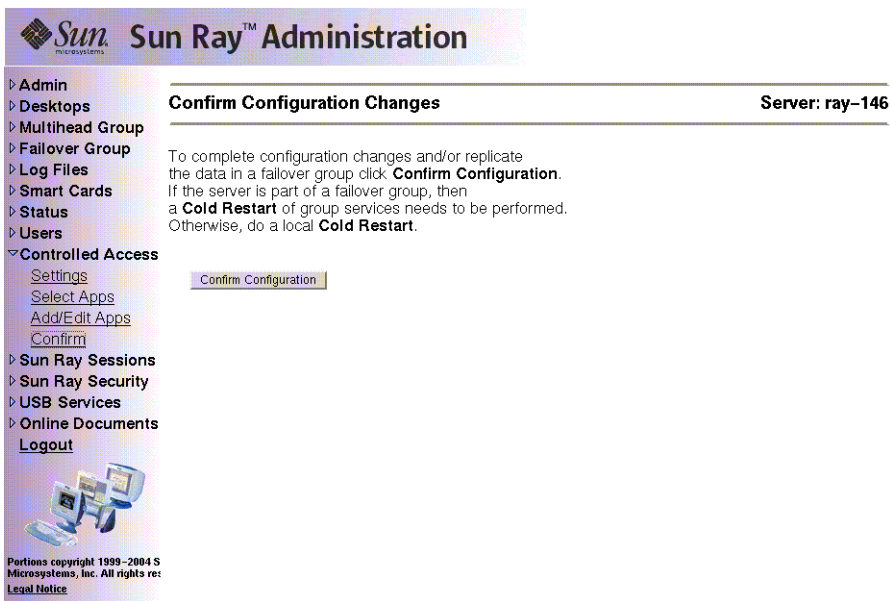

FIGURE 3-37 Confirmation Window

- Click the **Confirm Configuration** button.

Managing Sessions

A Sun Ray session is created when the user logs in to a Sun Ray DTU. A Sun Ray session has three possible states, as shown in TABLE 3-4.

TABLE 3-4 Sun Ray Session States

State	Description
Connected/disconnected	A session is currently displayed on a DTU.
Idling	The session is waiting at the Solaris login prompt.
Running/suspended	The session is running unless the startup process and its descendents are stopped.

▼ To Find Sun Ray Sessions

1. From the navigation menu, click the expansion arrow for Sun Ray Sessions.
2. From the expanded navigation menu, click the Find Sun Ray Sessions link.

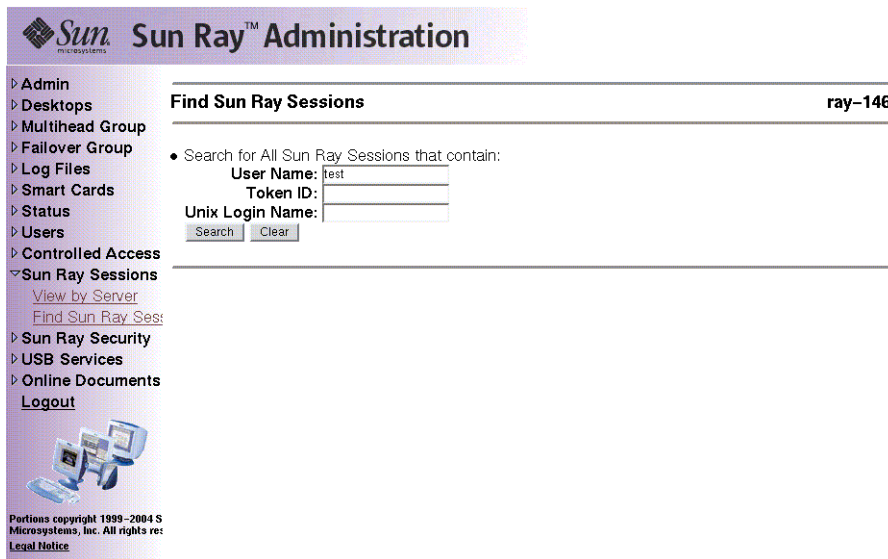

FIGURE 3-38 The Find Sun Ray Sessions Window

3. In the text fields, enter the User Name, Token ID, or Unix Login Name.
4. Click the Search button.

If you enter data in error, press the Clear button to clear entered data. The Sun Ray Sessions window is displayed with the Sun Ray search results.

Sun Ray Administration

Sun Ray Sessions Server: ray-146

Current time: Fri Sep 24 17:24:55 2004

Warning: Suspend and Resume options have been deprecated and will be removed in a future release

Running Sessions:

Token ID	User Name	Unix ID	Server	Connection	Display No	Action
MicroPayflex.5001437400130100	test1	test1	ray-146	Connect	3	None

Apply Reset

Portions copyright 1999-2004 S
Microsoft, Inc. All rights reserved.
[Legal Notice](#)

As usual, it is preferable to use the `utadmin` command rather than this visual display.

FIGURE 3-39 Sun Ray Sessions Window Showing Search Results

▼ To View Sun Ray Sessions

1. From the navigation menu, click the expansion arrow for Sun Ray Sessions.
2. From the expanded navigation menu, click the View by Server link.

Running sessions on the current server are displayed.

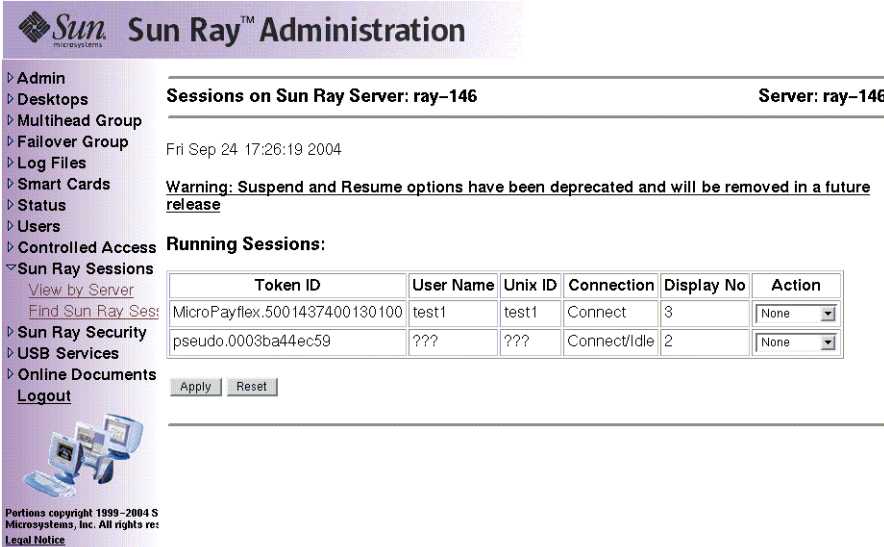

The screenshot shows the Sun Ray Administration web interface. The title is "Sun Ray™ Administration". On the left is a navigation menu with items like Admin, Desktops, Multihead Group, Failover Group, Log Files, Smart Cards, Status, Users, Controlled Access, Sun Ray Sessions (expanded), Sun Ray Security, USB Services, Online Documents, and Logout. The main content area shows "Sessions on Sun Ray Server: ray-146" and "Server: ray-146". Below this is a date "Fri Sep 24 17:26:19 2004" and a warning: "Warning: Suspend and Resume options have been deprecated and will be removed in a future release". A section titled "Running Sessions:" contains a table with columns: Token ID, User Name, Unix ID, Connection, Display No, and Action. The table lists two sessions: one for user 'test1' with Token ID 'MicroPayflex.5001487400130100' and another for user '???' with Token ID 'pseudo.0003ba44ec59'. Each session has an 'Action' dropdown menu currently set to 'None'. Below the table are 'Apply' and 'Reset' buttons. At the bottom left, there is a copyright notice: "Portions copyright 1999-2004 S Microsystems, Inc. All rights reserved. Legal Notice".

Token ID	User Name	Unix ID	Connection	Display No	Action
MicroPayflex.5001487400130100	test1	test1	Connect	3	None
pseudo.0003ba44ec59	???	???	Connect/Idle	2	None

FIGURE 3-40 Sessions on Current Sun Ray Server Window

3. To change the state of any of the displayed sessions, use the Action pull-down menu button to display your choices.

There are three possible actions: None, Terminate, and Suspend.

4. To apply your changes, click the Apply button.

Peripherals for Sun Ray DTUs

This chapter contains information about selected USB, parallel, and serial devices and printing from Sun Ray DTUs.

- “Device Nodes and USB Peripherals” on page 81
- “Mass Storage Devices” on page 84
- “Attached Printers” on page 86
- “PDA Synchronization” on page 89
- “Adapters” on page 90

There are two kinds of peripherals: serial and parallel. Serial peripherals enable RS-232-style serial connections to the Sun Ray DTU. Parallel peripherals enable printing and come in two types: adapters and direct USB-connected printers.

Third-party adapters are useful for supporting legacy serial and parallel devices.

Sun Ray Server Software recognizes a parallel printer with an adapter as a USB printer.

Note – The printer naming conventions in Sun Ray Server Software differ from those in a Solaris operating environment.

Device Nodes and USB Peripherals

Sun Ray Server Software creates a device directory called `IEEE802.MACID` in the `/tmp/SUNWut/units` directory. This directory contains the MAC address for each DTU on the interconnect. The `IEEE802.MACID` directory for each DTU contains `dev` and `devices` directories, analogous to the `/dev` and `/devices` directories in the Solaris operating environment. The Sun Ray `dev` directory contains a

representation of the logical topology of the devices connected to the DTU. The Sun Ray devices directory contains a representation of the physical topology of some of the devices connected to the DTU.

Note – Sun Ray Server Software does not create device nodes for every USB device. Some USB device drivers export their device interfaces through other mechanisms than a traditional UNIX device node.

Directories correspond to buses and hubs, and files correspond to ports. Hub directories are named according to the port on the upstream hub into which they are attached.

Device Nodes

In Sun Ray devices, device nodes are created for each serial or printer port on an attached USB device. The device nodes are created in the hub directory corresponding to the hub to which they are attached. They are named:

manufacturer_name, model_name@upstream_hub_port

If the USB device has multiple identical ports (for example, two serial ports), the name is followed by *:n* where *n* is a numerical index, starting at 1.

The following is a typical device node path:

/tmp/SUNWut/units/IEEE802.MACID/devices/usb@1/hub@1/\nmanufacturer_name, model_name@3:1

TABLE 4-1 Definitions of Naming Conventions

Term	Definition
<i>physical topology</i>	The <i>physical topology</i> is <i>hub@port/hub@port</i> and so on. The <i>port</i> refers to the port on the parent hub into which the device or child hub is plugged.
<i>printer name 1, terminal name 1</i>	The printer and terminal name in the Sun Ray devices directory is <i>manufacturer, model@port</i> with a colon separating the numerical index when the string just described is not unique in the directory.
<i>printer name 2, terminal name 2</i>	The printer and terminal name in the Sun Ray dev directory is the manufacturer and serial number concatenated with an alphabetic index when the serial number is not unique.

Device Links

Device links are created under the `dev` directory. A link to each serial node is created in `dev/term`, and a link to each parallel node is created in `dev/printers`.

Typical device links are:

```
/tmp/SUNWut/units/IEEE802.080020cf428a/dev/term/manufacturer_name-67a  
/tmp/SUNWut/units/IEEE802.080020cf428a/dev/printers/1608b-64
```

```
manufacturer_name-serial_numberindex
```

where *index* is an increasing alphabetical character, starting at `a`.

If the manufacturer name is not available, the USB vendor and product ID numbers are used for the name of the device link.

Device Node Ownership

Some device nodes are owned by the user whose session is active on the DTU, while others may be owned by root or by other users that may have had previously active sessions on the DTU. Device permissions, access controls and ownership rules are determined by the class of device. For serial and parallel devices, only the user whose session is active on the DTU or the superuser have permission to use the attached device. If there is no user with an active session, superuser owns the serial and parallel device nodes. This rule may not hold for other classes of USB devices connected to the DTU.

Hot Desking and Device Node Ownership

Note – The following description of the behavior of USB devices when sessions are connected and disconnected from a DTU applies only to USB serial and USB parallel devices. Other device classes may have different semantics regarding ownership and device lease times.

Changing the active session on a DTU changes the ownership of the device nodes to the user associated with the new session. A session change occurs whenever a user:

- Inserts or removes a smart card from a DTU
- Logs into a session

- Detaches from a session using non-smart card mobility

In a failover environment, you can use the `utselect` or `utswitch` command to change a session. A session change causes all devices currently open by a non-root user to be closed after 15 seconds. Any input or output to or from any affected device results in an error. Devices currently opened by the superuser, including normal Solaris printing, remain unaffected by the session change.

Note – When a session is changed, any input or output in progress on a device node opened by a non-root user is cancelled after 15 seconds. If the original session is restored within 15 seconds, the ownership is not relinquished, and input and output continue uninterrupted.

Mass Storage Devices

Device Nodes and Links

Mass storage devices have two types of device nodes, block and raw, which are created in the DTU's device directory. A link to the block device is created in the DTU's `dev/dsk` directory and a link to the raw device is created in the `dev/rdisk` directory.

Device links have a suffix denoting their slice number. Slice `s2` is known as the backup slice, signifying the complete disk. Other slices are numbered according on the filesystem on the disk. For UFS disks, slice numbers are derived from the disk label. For FAT disks, slices (partitions in this case) are numbered starting from `s0`. Disk operations such as `format` or `eject` should be directed at slice `s2`. Partition operations such as `mount` or `fstyp` should be directed at the individual slice concerned. See Table 4-2 on page 86 for examples.

Mount Points

When a mass storage device is plugged into the DTU, if it has a Solaris-recognizable file system, it is automatically mounted on a directory under the user's mount parent directory. The mount parent directory is located in `/tmp/SUNWut/mnt/username`, where *username* is the user's login name. The user can also locate mount points by using the `-l` option to the `utdiskadm` command:

```
% /opt/SUNWut/bin/utdiskadm -l
```

Device Ownership and Hot Desking

When the user's session disconnects from the DTU, the user loses access rights to the mass storage device. All pending I/O to the device is aborted. This can cause the data on the device to be corrupted. Please advise users to use the `utdiskadm` command as follows to unmount all filesystems safely before hot desking or unplugging the disk from the DTU:

```
% /opt/SUNWut/bin/utdiskadm -r device_name
```

Note – Before running this command, close all references to files and directories in the mount point to ensure that the device is not busy.

Mass Storage Devices and NSCM

If an active NSCM session becomes idle long enough to activate the screen lock, the NSCM session is disconnected. The user loses access to the storage device, causing any I/O in progress to abort, and data may become corrupted.

Common Disk Operations

TABLE 4-2 is a summary of common disk operations and the commands used to perform them. Refer to the *Solaris System Administration Guide* and man pages for more information on the individual commands.

TABLE 4-2 Commands for Common Disk Operation

OPERATION	COMMAND	DEVICE NAME ARGUMENT EXAMPLES
format	rmformat (1)	path of backup slice \$UTDEVROOT/dev/rdisk/disk3s2
create file system	mkfs (1M)	path of partition \$UTDEVROOT/dev/rdisk/disk3s2
create UFS file system	newfs (1M)	path of partition \$UTDEVROOT/dev/rdisk/disk3s0
mount	utdiskadm -m	partition name disk3s0
unmount	utdiskadm -u	mount point \$DTDEVROOT/mnt/disk3s0
prepare to unplug	utdiskadm -r	device alias disk3
eject media	utdiskadm -e	device alias disk3
check for media	utdiskadm -c	device alias disk3
create fdisk table	fdisk (1M)	path of backup slice \$UTDEVROOT/dev/rdisk/disk3s2
repair file system	fsck (1M)	path of partition \$UTDEVROOT/dev/rdisk/disk3s0
display file system capacity	df -k	\$DTDEVROOT/mnt/disk1s0
display slice capacity	prtvtoc (1M)	path of backup slice \$UTDEVROOT/dev/rdisk/disk3s2
list devices	utdiskadm -l	none

Attached Printers

Sun Ray Server Software 3 supports PostScript™ printers connected directly to a USB port on the Sun Ray DTU or connected through a USB-to-parallel port adapter. For non-PostScript printer support, refer to “Printers Other Than PostScript Printers” on page 89.

Note – The `lp` subsystem opens the device node as superuser for each print request, so print jobs are not affected by hot desking.

For more information on Solaris Ready™ printers, go to:

<http://www.sun.com/solarisready/>

Printer Setup

Starting a print queue on a printer attached to a Sun Ray DTU, either directly or through an adapter, is identical to starting a print queue in the Solaris operating environment.

▼ To Set Up a Printer

1. **Log in as superuser on a Sun Ray DTU.**
2. **To determine the MAC address of the DTU, press the three audio option keys to the left of the power key in the upper right corner of the keyboard.**

The alphanumeric string displayed above the connection icon is the MAC address.

3. **To locate the Sun Ray DTU, type:**

```
# cd /tmp/SUNWut/units/*MAC_address
# pwd
/tmp/SUNWut/units/IEEE802.MACID/
```

The path to the extended MAC address for your particular Sun Ray DTU is displayed.

4. **Locate the port for the printer by typing:**

```
# cd dev/printers
# pwd
/tmp/SUNWut/units/IEEE802.MACID/dev/printers
#ls
printer-node-name
```

5. **In the directory, locate the printer node.**

6. Start the Administration Tool by typing:

```
# admintool &
```

7. Go to Browse -> Printers -> Edit -> Add -> LocalPrinter.

8. Type in:

a. **Printer name:** *printername*

b. **Description (optional)**

c. **Printer Port**

Choose Other to enter the printer port path name, using the resulting directory from Step 4.

```
/tmp/SUNWut/units/IEEE802.MACID/dev/printers/printer-node-name
```

Note – Do not use the port name under the `devices` directory.

d. Click OK.

e. **If you are using a PostScript printer, under Printer Type choose PostScript unless your printer is listed.**

Select the printer type according to your printer model. If no option matches, select **other**; then type your printer type or **unknown**.

f. **If you are using a PostScript printer, under File Contents choose PostScript and ASCII.**

g. **Options: Default Printer (optional)**

h. Click OK.

Note – Do not click OK more than once. If you do, a failure message is displayed.

9. To verify that the printer has been set up correctly, type:

```
# lpstat -d printername
```

Printers Other Than PostScript Printers

Printers that do not use PostScript, such as engineering plotters, are best supported by third-party software. Low-cost inkjet printers require third-party software such as:

- Easy Software's ESP PrintPro, available from <http://www.easysw.com>
- Ghostscript, available from <http://www.ghostscript.com>
- Vividata PShop, available from <http://www.vividata.com>

Check with the vendors for pricing and the precise printer models supported.

PDA Synchronization

To synchronize PDAs that use the Palm OS to a Sun Ray DTU, use a USB-to-serial adapter. For troubleshooting information, see "PDA Synchronization Issues" on page 220.

PDASync for Solaris Application on Sun Ray DTUs

PDASync for Solaris™ requires a compatible version of the Java Communications API 2.0.2 or a later version to run on the Sun Ray DTU. Version 3 or later is recommended.

Certain components of the Java Communications API package must be installed in specific directories for PDASync for Solaris to run.

▼ To Set Up the PDASync Application on a Sun Ray DTU

1. **Log in as superuser.**
2. **Get the latest Java Communications API (javadoc.comm api version 3 and above) from**
<http://javadoc.sun.com/products/javacomm/>
3. **Unzip the file by typing:**

```
# unzip comm3.0_solaris.zip
```

4. Copy the CommAPI jar file into the PDASync installation base by typing:

```
# cp commapi/jar/comm.jar /usr/dt/appconfig/sdtpdasync/classes
```

5. Copy the CommAPI native library into the PDASync installation base by typing:

```
# cp commapi/lib/libSolarisSerialParallel.so \  
/usr/dt/appconfig/sdtpdasync/lib
```

6. Launch the PDASync application by typing:

```
# /usr/dt/bin/sdtpdasync
```

Adapters

For a list of verified serial and parallel adapters, see:

http://www.sun.com/io_technologies/sunray/usb/sunray-usb.html

libusb

libusb is an Open Source user land USB API/library that enables an application to access USB devices. libusb has been implemented for a number of operating environments, including Linux, BSD, MacOS, and Windows, as well as for Solaris and Sun Ray environments.

libusb applications are capable of running on any operating environment that supports libusb. Sun Ray support for libusb requires two packages

- SUNWlibusb
- SUNWlibusb

For further information, see `/usr/sfw/share/doc/libusb/libusb.txt`.

SUNWlibusb is installed as part of SRSS 3. The SUNWlibusb package can be installed manually from the Supplemental area of the SRSS 3 CD.

If the SUNWlibusb package has not already been installed, the administrator should install it and then create a symbolic link as follows:

```
# cd /usr/sfw/lib/libusb_plugins
# ln -s /opt/sunwut/lib/libusb.so.1
```

The SRSS 3 Companion CD contains some Open Source applications that make use of libusb support and enable users to access scanners, digital cameras, and other devices. The Companion CD also contains Solaris binaries for certain Open Source applications:

TABLE 4-3 Open Source libusb Applications

Application	URL	Comments
Sane	http://www.sane-proj.org	For scanner support
Gphoto	http://www.gphoto.org	For digital still cameras
ColdSync	http://www.coldsync.org	For Palm device support

For further information, please see:

- Documentation provided in the Supplemental area and <http://www.libusb.sourceforge.net>.
- Sun Download Center
- The libusb man page

Mobile Sessions (Hot Desking)

The Sun Ray system is designed, in part, to enable hot desking with Smart Cards, and every Sun Ray DTU is equipped with a Smart Card reader. Sun Ray Server Software 3 also includes the industry standard PC/SC-lite API for developers who wish to encode custom applications or other information in their users' Smart Cards. Custom applications are frequently used to provide strong smart card-based authenticated logins and PKCS#11, S/MIME digital signature message signing and encryption, among other capabilities. This enhancement requires no additional administration.

Configuring Sun Ray Server Software with non-smart card mobile (NSCM) sessions provides the benefits of hot desking without the use of smart cards. This chapter explains NSCM sessions and how to configure them.

This chapter contains the following sections:

- "NSCM Session" on page 93
- "NSCM and Failover Groups" on page 98
- "Configuring the Authentication Manager for NSCM Sessions" on page 99

NSCM Session

In an NSCM session, the user:

- Types a user name and password instead of inserting a smart card
- Types the `utdetach` command instead of removing a smart card.

If a user does not want to use the NSCM session, inserting a smart card causes the session to be disconnected and replaced by a smart card session.

Sun Ray Mobile Session Login Dialog Box

When Sun Ray Server Software is configured for NSCM sessions, the Sun Ray Mobile Session Login dialog box is displayed on the Sun Ray DTU.



FIGURE 5-1 Sun Ray Mobile Session Login Dialog Box

A right click on the Options button opens a panel where the user can select:

- QuickLogin—To a new session only. Selecting Off enables the user to login with the same options available through `dtlogin`. Selecting On enables the user to bypass the option selection phase. QuickLogin is on by default.
- Exit—Selecting Exit temporarily disables the NSCM session. An escape token session is started, and the dialog box is replaced by the `dtlogin` screen. Users without a valid username for this server group can exit so as to make a remote login to a server where their user name is valid.

Token Reader Icon

When a site policy disallows NSCM sessions, DTUs configured as token readers display the token reader icon instead of the Login Dialog box.



▼ To Log In to an NSCM Session

1. Type a user name and then a password into the user entry field.

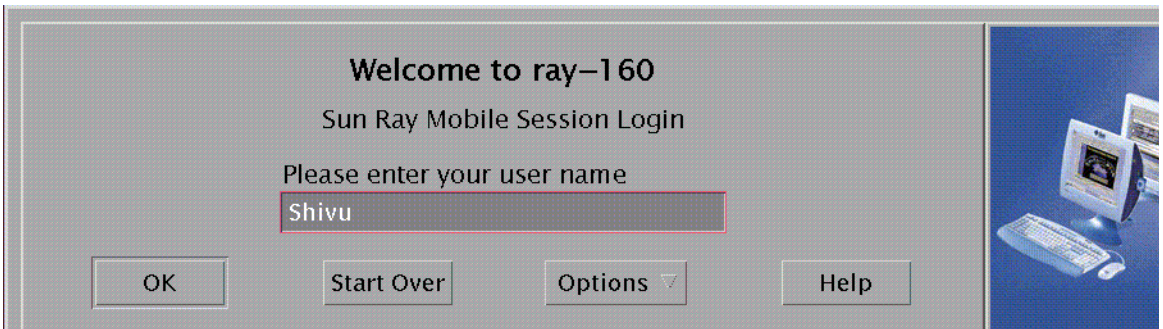

FIGURE 5-2 User Name Entry

If an NSCM session for this user does not exist, the Authentication Manager creates an NSCM session token for the user. The token has the format: `mobile.username`, where `username` is the user's identification.

If the Sun Ray server is part of a failover group, the load-balancing algorithm may redirect the user to another Sun Ray server, where the user types a username and password again before an NSCM session is created.

If an NSCM session exists on a different Sun Ray server in a failover group, the user is redirected to the server where the most current NSCM session is located.

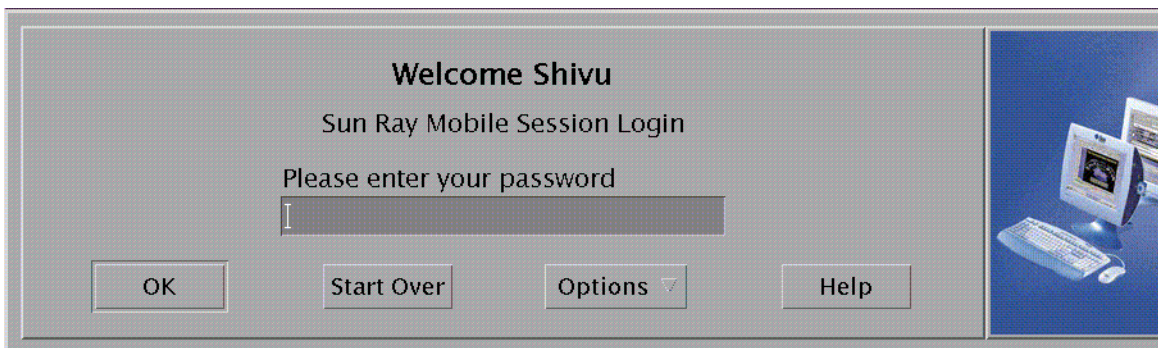

FIGURE 5-3 User Password Entry

The Sun Ray Mobile Session Login dialog box is redisplayed with the host name of the new Sun Ray server, and the user must retype the user name and password.

Note – The user may be redirected either for server load balancing or because there is a disconnected session on another server. For added security, each redirection requires re-authentication, so the user must re-enter a user name and password.

Note – In previous versions, the Sun Ray administrator could prevent re-authentication behavior by setting the `acceptRedirectToken` property in the `/etc/opt/SUNWut/auth.props` file to `true`, after which users did not need to re-authenticate when redirected. This functionality is no longer enabled.

Disconnecting an Active NSCM Session

If an NSCM session exists on the current Sun Ray server, the session is displayed to the user. If a user wants to move to another location, there are two methods of disconnecting an NSCM session:

- Hot Key combination
- `utdetach`

Hot Key

To disconnect a NSCM session, the user presses the key combination Shift-Pause.

▼ To Disconnect the Current Session via `utdetach`

1. Type the `utdetach` command in a shell window:

```
% /opt/SUNWut/bin/utdetach
```

2. Press the Shift and Pause keys simultaneously.

The Sun Ray Mobile Session Login dialog box is redisplayed, and the user moves to another Sun Ray DTU.

3. Login at the second Sun Ray DTU.

The session becomes active.

The user can terminate the session by clicking the Exit button in the CDE panel or by pressing the key combination `Ctrl+Alt+Bksp`, `Bksp`.

Note – The user may decide not to disconnect the session before moving to another Sun Ray DTU. Upon repeating Step 1, the user’s session is disconnected from the previous DTU and connected to the current DTU.

▼ To Terminate the Current Session

- Click the Exit button on the CDE panel.
- or
- Press the Ctrl+Alt+Bksp+Bksp key combination.

▼ To Reconfigure the Disconnect Hot Key Combination

You can change the disconnect key combination (hot key) in the `/etc/opt/SUNWut/utslaunch_defaults.properties` file, where the site-wide default configuration of the hotkey key combination is specified. Individual users can override the default key combination by configuring the `~/.utslaunch.properties` file located in their home directory.

- **Edit the respective file and find the line with the `utdetach.hotkey` property.** Change the string after the equals sign to the keystrokes desired. For example, to configure the key combination of Alt + Esc, type:

```
% utdetach.hotkey=Alt Escape
```

▼ To Customize the Short Cut for Disconnecting an NSCM Session

You can disconnect the current session using the key combination (hot key) in the `utslaunch.properties` files.

1. **To reconfigure the hot key combination, edit the file and find the line with the `utdetach.hotkey` property.**
2. **Change the string after the equals sign to the keystrokes desired.**

For example:

```
utdetach.hotkey=Alt Escape
```

configures the key combination of Alt+Esc.

NSCM and Failover Groups

The user login experience for NSCM sessions may be different than expected when systems are configured as part of a failover group.

The Sun Ray Authentication Manager uses a properties file, `/etc/opt/SUNWut/auth.props`. When the system is first configured, the `acceptRedirectToken` property in this file is set to `false` to support a model of high security by default. Because the property is set to `false`, the following situations may produce unfamiliar behavior:

Load Balancing Between Servers

If server A is heavily loaded when a user logs into it with the NSCM GUI, it redirects the user to server B, which requires another login with the NSCM GUI. If server B is running an earlier Solaris version than Server A, the user must log in a third time. Thus, the user gets a session, but only after three logins. Users accustomed to smart card ease of use might find this repetitious behavior confusing or annoying.

Switching Between Servers

A user with a session on server A who wants to switch to a session on server B invokes the `utselect` GUI to access the other session. In doing so, the user is required to log in with the NSCM GUI. Users familiar with the ease of the `utselect` GUI might be discouraged that another log in is necessary.

Escape Token Sessions

The user bypasses the NSCM GUI by clicking the Exit button and logs into server A using `dtlogin`. The user now has a standard escape token session and invokes the `utselect` GUI to switch to server B and, in doing so, is presented with the NSCM GUI. The user must click Exit again to get to the escape token session on server B.

Users accustomed to a quick switch might be annoyed that they must interact with the NSCM GUI a second time.

Configuring the Authentication Manager for NSCM Sessions

The Sun Ray administrator can enable the NSCM session features with:

- Sun Ray Administration Tool
- Command-line interface

Note – If the IP addresses and DHCP configuration data are not set up properly at the time that the interfaces are configured, the failover feature will not work properly. In particular, configuring the Sun Ray server’s interconnect IP address as a duplicate of any other server’s interconnect IP address may cause the Sun Ray Authentication Manager to generate “Out of Memory” errors.

▼ To Enable NSCM Sessions From the Administration Tool

1. **Before changing the Authentication Manager policy, inform your users that all active and detached sessions will be lost.**

You can use the `utwall` command to send the notice of policy change. For example:

```
# /opt/SUNWut/sbin/utwall -d -t 'System policy will change in 10 minutes.\nAll active and detached sessions will be lost.\nPlease save all data and terminate your session now.' ALL
```

The following message is seen by all users in a pop-up window:

```
System policy will change in 10 minutes.\nAll active and detached sessions will be lost.\nPlease save all data and terminate your session now.
```

2. **Log in to the Administration Tool.**
3. **From the task list, select Admin and click the Policy link.**
The Change Policy window is displayed.
4. **In the Non-Card Users column, check the Enable Mobile Sessions box.**

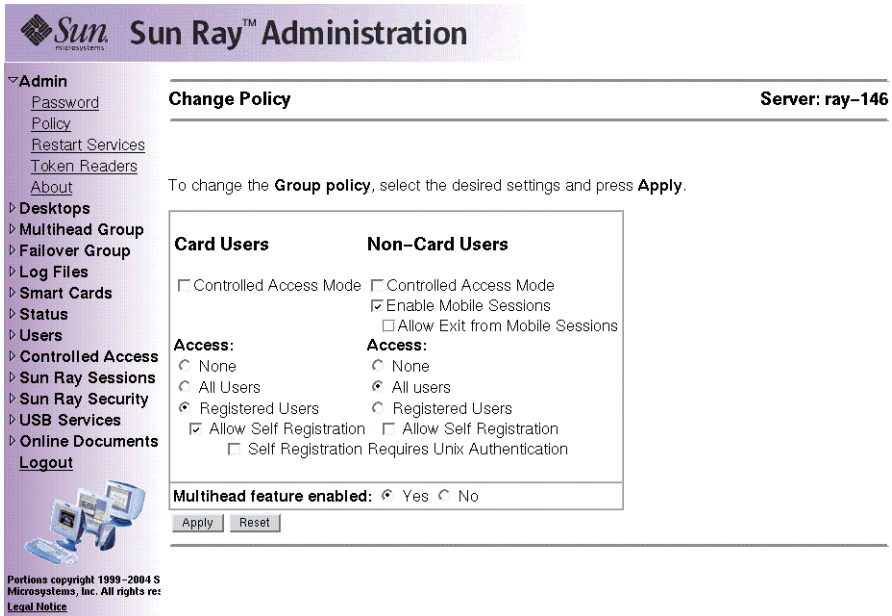

FIGURE 5-4 Change Policy Window

5. Click the **Apply** button.

When the policy change is complete, you are shown a confirmation window.

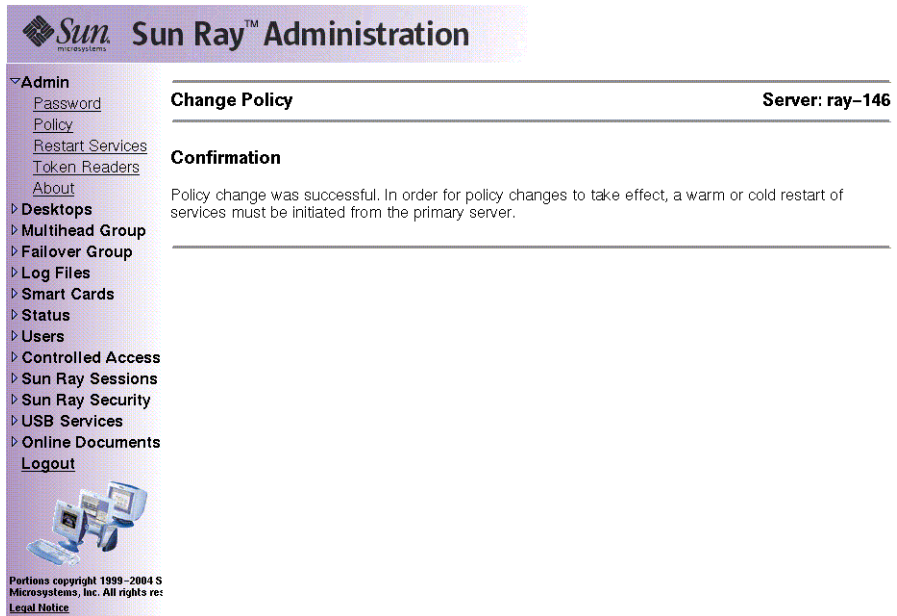

FIGURE 5-5 Change Policy Confirmation Window

6. From the task list, select **Admin** and click the **Reset Services** link.
The Sun Ray Services panel is displayed.
7. Select **Group** if this is a failover group or **Local** if there is a single Sun Ray server.
8. Click **Restart** to restart Sun Ray services and terminate all users' sessions.
The NSCM sessions are enabled in a moment.

▼ To Enable NSCM Sessions From a Command Line

The Sun Ray administrator can toggle the NSCM session capability by including or excluding the `-M` argument in the `utpolicy` command. For more information, see the `utpolicy` man page.

1. **Before changing the Authentication Manager policy, inform your users that all active and detached sessions will be lost.**

You can use the `utwall` command to provide them the notice of policy change. For example:

```
# /opt/SUNWut/sbin/utwall -d -t 'System policy will change in 10
minutes.\nAll active and detached sessions will be lost.\nPlease
save all data and terminate your session now.' ALL
```

The following message is seen by all users in a pop-up window:

```
System policy will change in 10 minutes.
All active and detached sessions will be lost.
Please save all data and terminate your session now.
```

2. **As superuser, type the `utpolicy` command for your authentication policy with the addition of the `-M` argument. For example:**

```
# /opt/SUNWut/sbin/utpolicy -a -M -s both -r both
```

This example configures the Authentication Manager to allow self-registration of users both with or without smart cards, and NSCM sessions are enabled.

3. **Initialize Sun Ray services.**

- a. **Type this command to restart the Authentication Manager.**

```
# /opt/SUNWut/sbin/utrestart -c
```

This command clears all active and detached sessions

- b. **Repeat Step a on each secondary Sun Ray server if in a failover group.**

Encryption and Authentication

SunRay Server Software provides interconnect security. Two main aspects of this feature are:

- Traffic encryption between the SunRay client and server
- SunRay server-to-client authentication

Introduction

In earlier versions of Sun Ray Server Software, data packets on the SunRay interconnect were sent in the clear. This made it easy to “snoop” the traffic and recover vital and private user information, which malicious users might misuse. To avoid this type of attack, SunRay Server Software allows administrators to enable traffic encryption. This feature is optional; the system or network administrator can configure it based on site requirements.

The ARCFOUR encryption algorithm, selected for its speed and relatively low CPU overhead, supports a higher level of security between Sun Ray services and SunRay desktop units. In the 2.0 release, only the X server traffic was encrypted.

Encryption alone does not provide complete security. It is still possible, if not necessarily easy, to spoof a SunRay server or a SunRay client and pose as either. This leads to the man-in-the-middle attack, in which an impostor claims to be the SunRay server for the clients and pretends to be client for the server. It then goes about intercepting all messages and having access to all secure data.

Client and server authentication can resolve this type of attack. This release offers server-side authentication only, through the pre-configured public-private key pairs in Sun Ray Server Software and firmware. The Digital Signature Algorithm (DSA) is used to verify that clients are communicating with a valid Sun Ray server. This

authentication scheme is not completely foolproof, but it mitigates trivial man-in-the-middle attacks and makes it harder for attackers to spoof Sun Ray Server Software.

Security Configuration

When configuring the security for a Sun Ray system, you should evaluate the security requirements. You may choose:

- to enable encryption for upstream traffic only
- to enable encryption for downstream traffic only
- to enable bidirectional encryption
- to enable server authentication (client authentication is not currently available)

Additionally, you must decide whether to enable hard security mode. To configure your site, you can use the `utcrypto` command or the Sun Ray Administration Tool (Admin GUI).

Security Mode

Hard security mode ensures that every session is secure. If security requirements cannot be met, the session is refused. Soft security mode ensures that every client that requests a session gets one; if security requirements cannot be met, the session is granted but not secure.

For example, in hard security mode, if any SunRay DTU that does not support security features (for instance, because of old firmware) connects to a Sun Ray server, the server denies the session.

In soft security mode, given the above situation, the SunRay server grants the DTU a non-secure session. It is now up to the user to decide whether to continue using a non-secure session.

For more information, please see the man page for `utcrypto` or “Administration Tool” on page 33.

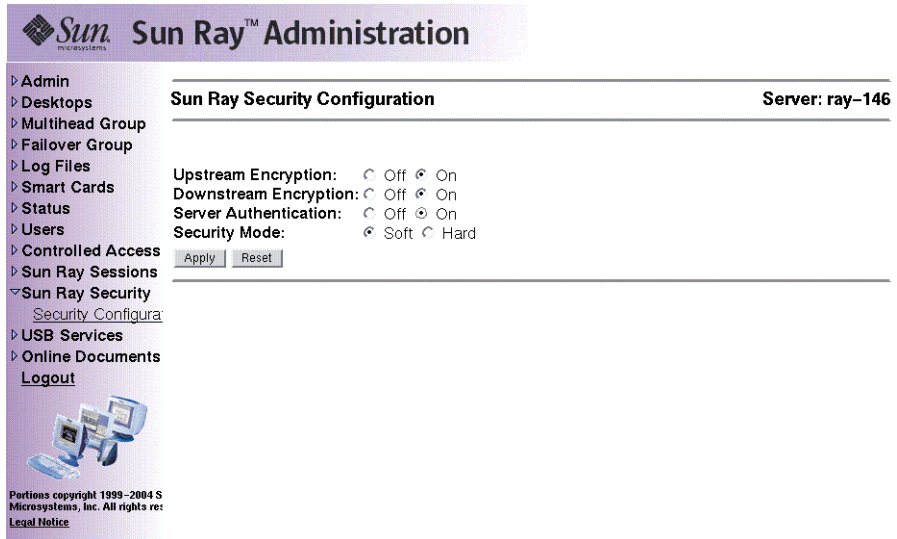

FIGURE 6-1 Sun Ray Security Configuration Window

Session Security

Use the `utsession` command to display session status. Its output has been modified to include security status for a session. The State column in `utsession -p` output now displays the encrypted/authenticated state of the session by using *E* for encrypted and *A* for authenticated session types. This information is not displayed for any session in the disconnected state.

In a multihead environment, there may be a case where the primary and the secondary servers have different firmware. For instance, if the secondary has version 1.3 or earlier firmware, it cannot support any of the security features. In this case, the lowest security setting is displayed. In other words, if the secondary server is configured with 1.3 firmware and the primary server with 2.0 or version 3 firmware, and encryption and authentication are configured, neither an *E* or an *A* is displayed.

```
# utsession -p
Token ID Registered NameUnix IDDisp State
Payflex.0000074500000202 ??? ??? 2IEA
Micropayflex.000003540004545??????3D
```

Security Status

Once a connection has been successfully established between a client and a server, the user can determine whether the connection is secure at any time by pressing the three volume keys together (currently used to determine MAC address of the terminal).

One of the following icons is also displayed when a Sun Ray DTU connects to a session. Each icon displays information about connection security status.

There are several variations on the security icon:

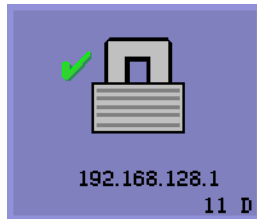

Locked Authenticated

The server is authenticated to the client and the data link is encrypted.



Locked Not Authenticated

The server is not authenticated to the client and the data link is encrypted.



Unlocked Not Authenticated

The server is not authenticated to the client and the data link is not encrypted.



Unlocked Authenticated

The server is authenticated to the client but the data link is not encrypted.

Session Connection Failures

The following icons are displayed when there might be a security breach.



Session Refused

Definition: The client is refusing to connect to a server because it is unable to verify the validity of the Sun Ray server.

This error can occur only if an unknown Sun Ray server intercepts the messages and tries to emulate a valid Sun Ray server. *This is a session security breach.*

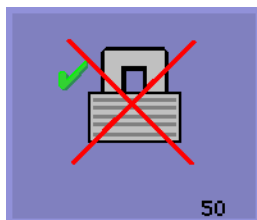

Session Refused

Definition: The server is refusing to grant a session to the client because the client is unable to fulfill the server's security requirements.

Actions to take:

- Check the client's firmware version. This error may occur with firmware versions earlier than 2.0 if the server is configured for hard security mode.
- Upgrade the firmware to version 2.0 or later, preferably to SRSS 3. As an alternative, confirm whether your site requires hard security mode. If not, the session can be enabled with soft security mode.

Deployment on Shared Networks

This chapter describes the process of deploying DTUs on shared network segments. It covers the following topics:

- “Sun Ray DTU Initialization Requirements” on page 109
- “Network Topology Options” on page 112
- “Network Configuration Tasks” on page 115
- “Network Performance Requirements” on page 132

When first introduced, Sun Ray DTUs could be deployed only on dedicated, directly-connected interconnect subnets. Although dedicated interconnects provide reliable service and are easy to configure, they require the full-time commitment of networking equipment, cabling, and host interfaces. This constraint has been removed from SRSS 2.0 and 3, allowing network administrators to deploy Sun Ray DTUs nearly anywhere on an enterprise intranet. The most important advantages of intranet deployment are:

- Sun Ray can be deployed on any existing network infrastructure that meets Sun Ray Quality of Service (QoS) requirements.
- Sun Ray DTUs can be deployed at a greater distance from their Sun Ray server.

Sun Ray DTU Initialization Requirements

Because Sun Ray DTUs are stateless, they rely entirely on network services to provide the configuration data they need to complete their initialization.

- Each DTU must first acquire basic network parameters, such as a valid IP address, on the network to which it is connected.
- The DTU can also be supplied with additional configuration information to support advanced product features, such as the ability to update the DTU firmware and to report exception conditions to a syslog service.

- The DTU must locate and contact a Sun Ray server that can offer desktop services to the Sun Ray user.

The Sun Ray DTU uses the Dynamic Host Configuration Protocol (DHCP) to obtain this information.¹

DHCP Basics

The DTU is a DHCP client that solicits configuration information by broadcasting DHCP packets on the network. The requested information is supplied by one or more DHCP servers in response to the client's solicitations. DHCP service may be provided by a DHCP server process executing on a Sun Ray server, by DHCP server processes executing on other systems, or by some combination of the two. Any conforming implementation of a DHCP service can be used to satisfy the DHCP requirements of the DTU. Sun's Solaris DHCP service is one such implementation. Third-party implementations executing on non-Sun platforms can also be configured to deliver information to Sun Ray DTUs.

The DHCP protocol defines a number of *standard options* that can be used to inform the client of a variety of common network capabilities. DHCP also allows for a number of *vendor-specific options*, which carry information that is meaningful only to individual products.

The Sun Ray DTU depends on a small number of standard options to establish its basic network parameters. It depends on several standard and vendor-specific options to provide the additional information that constitutes a complete DTU configuration. If these additional configuration parameters are not supplied, the DTU cannot perform certain activities, the most important of which is the downloading of new DTU firmware. TABLE 7-2 lists the vendor-specific options.

Note – If an administrator chooses not to make this additional configuration information available to the Sun Ray DTUs, a procedure must be established to deliver firmware updates to them. One solution would be a small, dedicated interconnect on one Sun Ray server. Then, the administrator can transfer the DTUs one-by-one when new firmware becomes available on the server, for instance, through a patch or Sun Ray product upgrade.

The location of the Sun Ray server is usually conveyed to the DTU through one of a pair of DHCP vendor-specific options, *AuthSrvr* and *AltAuth*.²

1. DHCP is an Internet Engineering Task Force (IETF) protocol described in Requests for Comments (RFC) *RFC 2131* and *RFC 2132*.

2. See Table 7-2 on page 130.

If the DTU does not receive this information, it uses a broadcast-based discovery mechanism to find a Sun Ray server on its subnet. The DTU firmware now goes one step further. If the broadcast-based discovery mechanism fails, the DTU interprets the DHCP standard option (option 49) of the *X Window Display Manager* as a list of Sun Ray server addresses where it attempts to contact Sun Ray services. This can simplify the DHCP configuration of LAN-deployed Sun Rays by removing the need for a DHCP vendor option to carry this information (see TABLE 7-1).

TABLE 7-1 DHCP Service Parameters Available

Parameters	Sun Ray Server DHCP Service	External DHCP service with vendor-specific options	External DHCP service without vendor-specific options	No DHCP service
Basic network parameters	Yes	Yes	Yes	No
Additional parameters (for firmware download, etc.)	Yes	Yes	No	No
Sun Ray server location	Yes	Yes	Yes, through broadcast discovery or the <i>X Display Manager</i> standard option	Yes, through broadcast discovery

DHCP Parameter Discovery

DHCP enables two stages of parameter discovery. The initial `DHCPDISCOVER` stage discovers basic network parameters. This stage may be followed by a `DHCPINFORM`, which finds additional information that was not provided during `DHCPDISCOVER`.

All Sun Ray DTUs must have access to at least one DHCP service, which provides network parameters in response to a `DHCPDISCOVER` request from the DTU. DTUs containing firmware delivered with Sun Ray Server Software 2.0 or later can exploit the `DHCPINFORM` feature. They enable full configuration of the DTU, even when an external DHCP service that is not capable of providing complete configuration data provides the network parameters of the DTU.

DTUs that contain pre-2.0 firmware require all of their configuration information in the initial `DHCPDISCOVER` phase. They do not attempt a `DHCPINFORM` step. If the deployment strategy requires a two-step DHCP interaction, such DTUs must be upgraded with Sun Ray Server Software firmware version 2.0 or later before being deployed on a shared subnet.

DHCP Relay Agent

The DTU sends DHCP requests as broadcast packets that propagate only on the local LAN segment or subnet. If the DTU resides on the same subnet as the DHCP server, the DHCP server can see the broadcast packet and respond with the information the DTU needs. If the DTU resides on a different subnet than the DHCP server, the DTU must depend on a local DHCP Relay Agent to collect the broadcast packet and forward it to the DHCP server. Depending on the physical network topology and DHCP server strategy, the administrator may need to configure a DHCP Relay Agent on each subnetwork to which Sun Ray clients are connected. Many IP routers provide DHCP Relay Agent capability. If a deployment plan requires the use of a DHCP Relay Agent, and the administrator decides to activate this capability on a router, the appropriate instructions can be found in the router documentation, usually under the heading of “DHCP Relay” or “BOOTP forwarding.”³

In certain cases, an existing enterprise DHCP service provides the DTU with its IP address while a Sun Ray server provides it with firmware version details and Sun Ray server location. If a deployment plan calls for DHCP parameters to be provided to the DTU by multiple servers, and none of those servers is connected to the subnet where the DTU resides, the DHCP Relay Agent should be configured so that the DTUs subnet can deliver broadcasts to all the DHCP servers. For example, in routers controlled by a Cisco IOS Executive, the `ip helper-address` command activates a DHCP Relay Agent. Specifying multiple arguments to the `ip helper-address` command enables relaying to multiple DHCP servers.

Network Topology Options

There are three basic topology options for Sun Ray deployment. DTUs can be deployed on:

- a directly-connected dedicated interconnect.
- a directly-connected shared subnet.
- a remote shared subnet.

A Sun Ray server can support any combination of these topologies, which are shown in FIGURE 7-1.

3. DHCP is derived from an earlier protocol called BOOTP. Some documentation uses these names interchangeably.

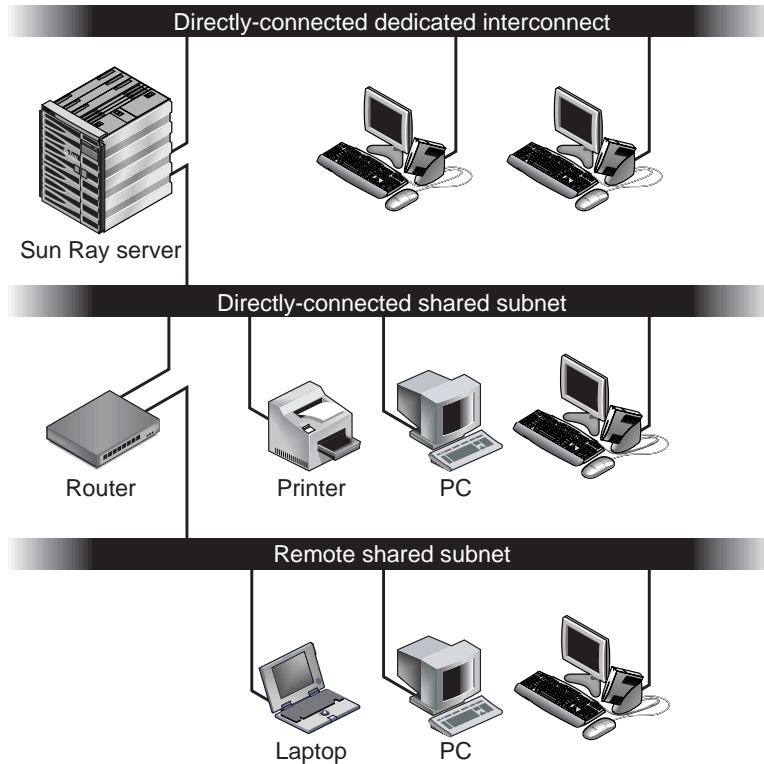

FIGURE 7-1 Network Topologies for Sun Ray DTU Deployment

Note – Sun Ray traffic on shared networks is potentially more exposed to an eavesdropper than traffic on a dedicated Sun Ray interconnect. Modern switched network infrastructures are far less susceptible to snooping activity than earlier shared technologies, but to obtain additional security the administrator may choose to activate Sun Ray's encryption and authentication features. These capabilities are discussed in "Encryption and Authentication" on page 103.

Directly-Connected Dedicated Interconnect

The *directly-connected dedicated interconnect*—often referred to simply as an interconnect—places DTUs on subnets that are:

- directly connected to the Sun Ray server (that is, the server has a network interface connected to the subnet).
- devoted entirely to carrying Sun Ray traffic. Prior to the release of Sun Ray Server Software 2.0, this was the only officially supported Sun Ray topology.

The Sun Ray server, which guarantees the delivery of the full set of DTU configuration parameters, is always used to provide DHCP service for a dedicated interconnect.

Directly-Connected Shared Subnet

Sun Ray Server Software now supports DTUs on a *directly-connected shared subnet*, in which:

- the Sun Ray server has a network interface connected to the subnet.
- the subnet may carry a mix of Sun Ray and non-Sun Ray traffic.
- the subnet is generally accessible to the enterprise intranet.

On a directly-connected shared subnet, DHCP service can be provided by the Sun Ray server, or some external server, or both. Since the Sun Ray server can see broadcast DHCP traffic from the DTU, it can participate in DTU initialization without requiring a DHCP Relay Agent.

Remote Shared Subnet

Sun Ray Server Software now also supports DTUs on a *remote shared subnet*. On a remote shared subnet:

- a Sun Ray server does not have a network interface connected to the subnet.
- the subnet can carry a mix of Sun Ray and non-Sun Ray traffic.
- all traffic between the server and the DTU flows through at least one router.
- the subnet is generally accessible to the enterprise intranet.

On a remote shared subnet, DHCP service can be provided by the Sun Ray server, by some external server, or by both. For DHCP service on the Sun Ray server to participate in DTU initialization, a DHCP Relay Agent must be configured on the remote subnet, where it collects DHCP broadcast traffic and forwards it to the Sun Ray server.

Network Configuration Tasks

The addition of directly-connected and remote shared subnet support allows DTUs to be deployed virtually anywhere on the enterprise intranet, subject only to the provision of DHCP service and a sufficient quality of service between the DTU and the Sun Ray server.

The following sections explain how to configure a network to support these deployment scenarios:

- a directly-connected dedicated interconnect
- a directly-connected shared subnet
- a remote shared subnet

FIGURE 7-2 shows the overall topology and configuration tasks.⁴

Preparing for Deployment

Before deploying a DTU onto any subnet, the administrator must answer three questions:

1. From which DHCP server will DTUs on this subnet get their basic IP networking parameters?
2. From which DHCP server will DTUs on this subnet get additional configuration parameters to support features such as firmware download?
3. How will DTUs on this subnet locate their Sun Ray server?

The answers to these questions determine what configuration steps will let DTUs placed on this subnet initialize themselves and offer Sun Ray sessions to users.

The following sections present examples of DTU deployment on the directly-connected dedicated interconnect A, the directly-connected shared subnet B, and the remote shared subnets C and D shown in FIGURE 7-2.

4. The /24 suffix in IP addresses indicates the use of Classless Inter Domain Routing (CIDR) notation, which is documented in IETF RFCs 1517, 1518, and 1519

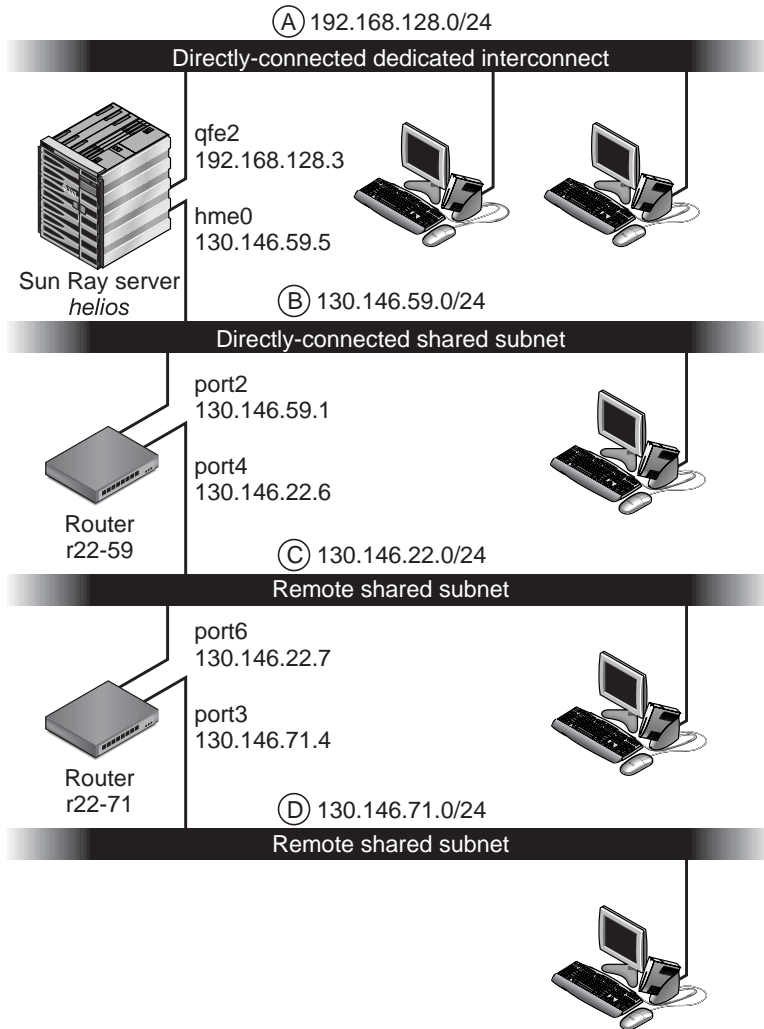

FIGURE 7-2 Sun Ray Network Topology

Deployment on a Directly-Connected Dedicated Interconnect

Subnet A in FIGURE 7-2 is a directly-connected dedicated interconnect. Its subnet will use IP addresses in the range 192.168.128.0/24. The Sun Ray server named *helios* is attached to the interconnect through its `qfe2` network interface, which will be assigned the IP address 192.168.128.3.

In an interconnect scenario, the DHCP service on the Sun Ray server always provides both basic networking parameters and additional configuration parameters to the DTU. The answers to the three pre-deployment questions are:

1. From which DHCP server will DTUs on this subnet get their basic IP networking parameters?

On a directly-connected dedicated interconnect, basic networking parameters are always supplied by the DHCP service on the Sun Ray server.

2. From which DHCP server will DTUs on this subnet get additional configuration parameters to support features such as firmware download?

On a directly-connected dedicated interconnect, additional configuration parameters are always supplied by the DHCP service on the Sun Ray server.

3. How will DTUs on this subnet locate their Sun Ray server?

On a directly-connected dedicated interconnect, the DTU is always notified of the location of the Sun Ray server through an additional configuration parameter supplied in Step 2.

Directly-Connected Dedicated Interconnect: Example

This is an example of DHCP service for the directly-connected dedicated interconnect A shown in FIGURE 7-2.

- 1. Configure the Sun Ray server to provide both basic and additional parameters to the interconnect.**

Use the `utadm -a ifname` command to configure DHCP service for DTUs on an interconnect. In this example, the interconnect is attached through interface `qfe2`, so the appropriate command is:

```
# /opt/SUNWut/sbin/utadm -a qfe2
### Configuring /etc/nsswitch.conf
### Configuring Service information for Sun Ray
### Disabling Routing
### configuring qfe2 interface at subnet 192.168.128.0
Selected values for interface "qfe2"
  host address:          192.168.128.1
  net mask:              255.255.255.0
  net address:          192.168.128.0
  host name:            helios-qfe2
  net name:             SunRay-qfe2
  first unit address:   192.168.128.16
  last unit address:    192.168.128.240
  auth server:         192.168.128.1
  firmware server:     192.168.128.1
  router:              192.168.128.1
  alternate servers:
```

```

Accept as is? ([Y]/N): n
new host address: [192.168.128.1] 192.168.128.3
new netmask: [255.255.255.0]
new host name: [helios-qfe2]
Do you want to offer IP addresses for this interface? ([Y]/N):
new first Sun Ray address: [192.168.128.16]
number of Sun Ray addresses to allocate: [239]
new auth server: [192.168.128.3]
new firmware server: [192.168.128.3]
new router: [192.168.128.3]
Specify alternate server list? (Y/[N]):
Selected values for interface "qfe2"
host address:          192.168.128.3
net mask:              255.255.255.0
net address:           192.168.128.0
host name:             helios-qfe2
net name:              SunRay-qfe2
first unit address:    192.168.128.16
last unit address:     192.168.128.254
auth server:           192.168.128.3
firmware server: 1     192.168.128.3
router:                192.168.128.3
alternate servers:
Accept as is? ([Y]/N):
### successfully set up "/etc/hostname.qfe2" file
### successfully set up "/etc/inet/hosts" file
### successfully set up "/etc/inet/netmasks" file
### successfully set up "/etc/inet/networks" file
### finished install of "qfe2" interface
### Building network tables - this will take a few minutes
### Configuring firmware version for Sun Ray
    All the units served by "helios" on the 192.168.128.0
    network interface, running firmware other than version
    "2.0_37.b,REV=2002.12.19.07.46" will be upgraded at their
    next power-on.
### Configuring Sun Ray Logging Functions
DHCP is not currently running, should I start it? ([Y]/N):
### started DHCP daemon
#

```

In this example, the default values initially suggested by utadm were not appropriate. (Specifically, the suggested value for the server's IP address on the interconnect was not the desired value.) The administrator replied **n** to the first `Accept as is?` prompt and was given the opportunity to provide alternative values for the various parameters.

2. Restart Sun Ray services on the Sun Ray server.

Once the `utadm` command has completed, issue a `utrestart` command to fully activate Sun Ray services on the newly-defined interconnect:

```
# /opt/SUNWut/sbin/utrestart
Resetting servers... messages will be logged to /var/opt/SUNWut/log/messages.
```

Deployment on a Directly-Connected Shared Subnet

Subnet B in FIGURE 7-2 is a directly-connected shared subnet that uses IP addresses in the range `130.146.59.0/24`. The Sun Ray server *helios* is attached to the interconnect through its `hme0` network interface, which has been assigned the IP address `130.146.59.5`. The answers to the three pre-deployment questions are:

1. From which DHCP server will DTUs on this subnet get their basic IP networking parameters?

In a shared subnet scenario, you must choose whether a DHCP service on the Sun Ray server or some external DHCP service will provide the DTU with basic network parameters. If the enterprise already has a DHCP infrastructure that covers this subnet, it probably supplies basic network parameters. If no such infrastructure exists, configure the Sun Ray server to provide basic network parameters.

2. From which DHCP server will DTUs on this subnet get additional configuration parameters to support features such as firmware download?

The administrator must choose whether to supply additional configuration parameters to the DTU and, if so, whether to use a DHCP service on the Sun Ray server or some external DHCP service for this purpose. On a directly connected shared subnet, it is possible to deploy DTUs without providing additional parameters at all, but since this deprives the DTU of a number of features, including the ability to download new firmware, it is generally undesirable.

Administrators of an already established DHCP infrastructure may be unable or unwilling to reconfigure that infrastructure to provide additional Sun Ray configuration parameters, so it is usually more convenient to have the Sun Ray server provide these parameters. Even when the established infrastructure is capable of delivering the additional parameters, it may be desirable to have the Sun Ray server provide them. This enables SRSS commands to be used to manage the values of the additional configuration parameters when those values need to be changed in response to software upgrades or patch installations on the Sun Ray server. For instance, a patch that delivers new DTU firmware could automatically update the firmware version string that is delivered to the DTU. However, if the firmware version parameter is supplied by some external DHCP

service, an administrator must manually edit the firmware version parameter string in the external DHCP configuration rules to reflect the new firmware version delivered by the patch. This activity is time-consuming and error-prone, as well as unnecessary.

3. How will DTUs on this subnet locate their Sun Ray server?

Use one of the optional additional configuration parameters to report the location of the Sun Ray server to the DTU. If additional configuration parameters are not supplied to the DTU at all, the DTU has no indication of the location of any Sun Ray server. In these circumstances, the DTU attempts to discover the location of a Sun Ray server by using a broadcast-based mechanism. However, the DTUs broadcast packets propagate only on the local subnet, so, in the case of a remote subnet, the broadcast cannot reach the Sun Ray server, and contact cannot be established.

The following examples illustrate two configurations of the directly connected shared subnet. In the first example, the Sun Ray server delivers both basic networking parameters and additional parameters. In the second example, an external DHCP service supplies basic networking parameters, and no additional parameters are provided to the DTU, which must establish contact with the Sun Ray server through its local subnet broadcast discovery mechanism.

The most likely case, where an external DHCP service provides basic networking parameter and the Sun Ray server provides additional parameters, is illustrated by an example in “Deployment on a Remote Subnet.”

Directly-Connected Shared Subnet: Example 1

In this example, the answers to the three pre-deployment questions are:

1. From which DHCP server will DTUs on this subnet get their basic IP networking parameters?

From the Sun Ray server.

2. From which DHCP server will DTUs on this subnet get additional configuration parameters to support features such as firmware download?

From the Sun Ray server.

3. How will DTUs on this subnet locate their Sun Ray server?

The DTUs will be informed of the location of the Sun Ray server through an additional configuration parameter delivered in Step 2.

1. Configure the Sun Ray server to provide both basic and additional parameters to the shared subnet.

DHCP service for DTUs on a shared subnet is configured through the `utadm -A subnet` command. In this example, the shared subnet has network number `130.146.59.0`, so the appropriate command is `utadm -A 130.146.59.0`:

```
# /opt/SUNWut/sbin/utadm -A 130.146.59.0
Selected values for subnetwork "130.146.59.0"
  net mask:                255.255.255.0
  no IP addresses offered
  auth server:             130.146.59.5
  firmware server:        130.146.59.5
  router:                  130.146.59.1
  alternate servers:
Accept as is? ([Y]/N): n
netmask: 255.255.255.0 (cannot be changed - system defined netmask)
Do you want to offer IP addresses for this subnet? (Y/[N]): y
new first Sun Ray address: [130.146.59.4] 130.146.59.200
number of Sun Ray addresses to allocate: [55] 20
new auth server:          [130.146.59.5]
new firmware server:     [130.146.59.5]
new router:              [130.146.59.1]
Specify alternate server list? (Y/[N]):
Selected values for subnetwork "130.146.59.0"
  net mask:                255.255.255.0
  first unit address:      130.146.59.200
  last unit address:       130.146.59.219
  auth server:             130.146.59.5
  firmware server:        130.146.59.5
  router:                  130.146.59.1
  alternate servers:
Accept as is? ([Y]/N):
### Building network tables - this will take a few minutes
### Configuring firmware version for Sun Ray
  All the units served by "helios" on the 130.146.59.0
  network interface, running firmware other than version
  "2.0_37.b,REV=2002.12.19.07.46" will be upgraded at
  their next power-on.
### Configuring Sun Ray Logging Functions
### stopped DHCP daemon
### started DHCP daemon
#
```

The default values initially suggested by `utadm` were not appropriate. Specifically, this server would not have offered any IP addresses on the `130.146.59.0` subnet because `utadm` assumes that basic networking parameters, including IP addresses,

are provided by some external DHCP service when the DTU is located on a shared subnet. In this example, however, the Sun Ray server is required to provide IP addresses, so the administrator replied **n** to the first `Accept as is?` prompt and was given the opportunity to provide alternative values for the various parameters. Twenty IP addresses, starting at `130.146.59.200`, were made available for allocation to DHCP clients on this subnet.

2. Restart Sun Ray services on the Sun Ray server.

Once the `utadm` command has completed, issue a `utrestart` command to fully activate Sun Ray services on the shared subnet:

```
# /opt/SUNWut/sbin/utrestart
Resetting servers... messages will be logged to /var/opt/SUNWut/log/messages.
```

Directly-Connected Shared Subnet: Example 2

In this example, the answers to the three pre-deployment questions are:

1. From which DHCP server will DTUs on this subnet get their basic IP networking parameters?

From an external DHCP service.

2. From which DHCP server will DTUs on this subnet get additional configuration parameters to support features such as firmware download?

The DTUs will not be supplied with additional parameters.

3. How will DTUs on this subnet locate their Sun Ray server?

By using the local subnet broadcast discovery mechanism.

In this example, the Sun Ray server does not participate in DTU initialization at all. Why, then, are configuration steps required on the Sun Ray server? The Sun Ray server responds by default only to DTUs located on directly connected dedicated interconnects. It responds to DTUs on shared subnets only if the `utadm -L on` command has been executed. Running the `utadm -A subnet` command to activate DHCP on the Sun Ray server for a shared subnet, as in this example, implicitly executes `utadm -L on`. If `utadm -A subnet` has not been run, the administrator must run `utadm -L on` manually to allow the server to offer sessions to DTUs on the shared subnet.

1. Configure the external DHCP service.

Determining how to configure the external DHCP infrastructure to provide basic networking parameters to the DTUs on this subnet is beyond the scope of this document. Bear in mind:

- If the external DHCP service does not have its own direct connection to this subnet, the administrator must configure a DHCP Relay Agent to deliver DHCP traffic on this subnet to the external DHCP service. The most likely location for such a Relay Agent would be on a router in this subnet, in this case the router named `r22-59` in FIGURE 7-2. For a brief introduction to this topic refer to “DHCP Relay Agent” on page 112.
 - An existing external DHCP service may need to have its IP address allocation for this subnet increased in order to support the new DTUs. (This applies whenever additional DHCP clients are placed on a subnet.) It might also be desirable to reduce the lease time of addresses on this subnet so that addresses become eligible for reuse quickly.
- 2. Configure the Sun Ray server to accept DTU connections from shared subnets.**

Run `utadm -L on`:

```
# /opt/SUNWut/sbin/utadm -L on
### Turning on Sun Ray LAN connection
NOTE: utrestart must be run before LAN connections will be allowed
```

3. Restart Sun Ray services on the Sun Ray server.

Once the `utadm` command has completed, issue a `utrestart` command to fully activate Sun Ray services on the shared subnet::

```
# /opt/SUNWut/sbin/utrestart
Resetting servers... messages will be logged to /var/opt/SUNWut/log/messages.
```

Deployment on a Remote Subnet

Subnets C and D in FIGURE 7-2 are remote shared subnets.

Subnet C uses IP addresses in the range `130.146.22.0/24`. Subnet D uses IP addresses in the range `130.146.71.0/24`. The Sun Ray server named *helios* has no direct attachment to either of these subnets; it is this characteristic that defines them as remote. The answers to the three pre-deployment questions are:

1. From which DHCP server will DTUs on this subnet get their basic IP networking parameters?

In a shared subnet scenario, the administrator must choose whether a DHCP service on the Sun Ray server or some external DHCP service will provide the DTU with basic network parameters.

If the enterprise already has a DHCP infrastructure that covers this subnet, it probably supplies basic network parameters. If no such infrastructure exists, configure the Sun Ray server to provide basic network parameters.

2. From which DHCP server will DTUs on this subnet get additional configuration parameters to support features such as firmware download?

The administrator must choose whether additional configuration parameters will be supplied to the DTU, and if so whether they will be supplied by a DHCP service on the Sun Ray server or by some external DHCP service.

Administrators of an established DHCP infrastructure may be unable or unwilling to reconfigure it to provide additional Sun Ray configuration parameters, so it is usually more convenient to have the Sun Ray server provide them.

Even when the established infrastructure is capable of delivering the additional parameters, it may be desirable to have the Sun Ray server provide them. This enables you to use Sun Ray Server Software commands to manage the values of the additional configuration parameters, when those values need to be changed in response to software upgrades or patch installations on the Sun Ray server. For instance, a patch that delivers new DTU firmware could automatically update the firmware version string delivered to the DTU. However, if the firmware version parameter is supplied by some external DHCP service, an administrator must manually edit the firmware version parameter string in the external DHCP configuration rules to reflect the new firmware version delivered by the patch. This kind of activity is time-consuming and error-prone as well as unnecessary.

3. How will DTUs on this subnet locate their Sun Ray server?

Use one of the optional additional configuration parameters to report the location of the Sun Ray server to the DTU. If additional configuration parameters are not supplied to the DTU at all, the DTU cannot locate a Sun Ray server, so it tries to discover the location of a Sun Ray server by using a broadcast-based mechanism. However, the DTUs broadcast packets propagate only on the local subnet; they cannot reach a Sun Ray server located on a remote subnet, and cannot establish contact.

The next two examples illustrate representative remote shared subnet configurations. In the first example, an external DHCP service provides basic networking parameters, and the Sun Ray server provides additional parameters. This is by far the most likely configuration for a Sun Ray deployment in an enterprise that has an established DHCP infrastructure.

In the second example, basic networking parameters and a bare minimum of additional parameters—just enough to enable the DTU to contact a Sun Ray server—are supplied by an external DHCP. In this case, it is the DHCP service in a Cisco router. This scenario is less than ideal.

No firmware parameters are delivered to the DTU, so it cannot download new firmware. The administrator must make some other arrangement to provide the DTU with new firmware, for instance, by rotating it off this subnet periodically onto an interconnect or onto some other shared subnet where a full set of additional configuration parameters is offered.

Note – For examples of shared subnet deployments in which both basic networking parameters and additional parameters are delivered by the Sun Ray server and basic networking parameters are supplied by an external DHCP service (with no additional DTU parameters provided), see Directly-Connected Shared Subnet.

Remote Shared Subnet: Example 1

In this example, in which DTUs are deployed on subnet C in FIGURE 7-2, the answers to the three pre-deployment questions are:

1. From which DHCP server will DTUs on this subnet get their basic IP networking parameters?

From an external DHCP service.

2. From which DHCP server will DTUs on this subnet get additional configuration parameters to support features such as firmware download?

From the Sun Ray server.

3. How will DTUs on this subnet locate their Sun Ray server?

The DTUs will be informed of the location of the Sun Ray server through an additional configuration parameter delivered in Step 2.

Use the `utadm -A subnet` command as follows to configure DHCP service for DTUs on a shared subnet.

1. Configure the External DHCP Service.

Determining how to configure the external DHCP infrastructure to provide basic networking parameters to the DTUs on this subnet is beyond the scope of this document. Bear in mind:

- If the external DHCP service does not have its own direct connection to this subnet, the administrator must configure a DHCP Relay Agent to deliver DHCP traffic on this subnet to the external DHCP service. The most likely location for such a Relay Agent would be on a router in this subnet, in this case the router named `r22-59` in FIGURE 7-2. For a brief introduction to this topic refer to DHCP Relay Agent.

- An existing external DHCP service may need to have its IP address allocation increased for this subnet to support the new DTUs. (This applies whenever additional DHCP clients are placed on a subnet.) It might also be desirable to reduce the lease time of addresses on this subnet so that addresses become eligible for re-use quickly.

2. Arrange to Deliver DHCP Traffic to the Sun Ray Server.

Because the Sun Ray server does not have its own direct connection to this subnet, the administrator must configure a DHCP Relay Agent to deliver the subnet's DHCP traffic to the Sun Ray server. The most likely location for such a Relay Agent would be on a router in this subnet, in this case the router named `r22-59` in FIGURE 7-2. For a brief introduction to this topic refer to DHCP Relay Agent.

If `r22-59` is running the Cisco IOS, the `ip helper-address` command can be used to activate its DHCP Relay Agent to relay DHCP broadcasts from its 10/100 Ethernet port number 4 to the Sun Ray server at `130.146.59.5`.

```
r22-59> interface fastethernet 4
r22-59> ip helper-address 130.146.59.5
r22-59>
```

If the external DHCP service also lacks a connection to this subnet, configure a DHCP Relay Agent to forward requests from the DTU to:

- The external DHCP service (so that the DTU can obtain basic networking parameters)
- The DHCP service on the Sun Ray server (so that the DTU can obtain additional parameters)

The Cisco IOS `ip helper-address` command accepts multiple relay destination addresses, so if, for instance, the external DHCP service could be contacted at `130.146.59.2` on subnet B in FIGURE 7-2, the appropriate sequence would be:

```
r22-59> interface fastethernet 4
r22-59> ip helper-address 130.146.59.2 130.146.59.5
r22-59>
```

Note – Details of the IOS interaction vary according to the specific release of IOS, the model of the router, and the hardware installed in the router.

3. Configure the Sun Ray server to provide additional parameters to the shared subnet.

Use the `utadm -A subnet` command to configure DHCP service for DTUs on a shared subnet. In this example, the shared subnet has network number 130.146.22.0, so the appropriate command is `utadm -A 130.146.22.0`.

```
# /opt/SUNWut/sbin/utadm -A 130.146.22.0
Selected values for subnetwork "130.146.22.0"
  net mask:                255.255.255.0
  no IP addresses offered
  auth server:             130.146.59.5
  firmware server:        130.146.59.5
  router:                  130.146.22.1
  alternate servers:
Accept as is? ([Y]/N): n
new netmask:[255.255.255.0]
Do you want to offer IP addresses for this subnet? (Y/[N]):
new auth server:[130.146.59.5]
new firmware server:[130.146.59.5]
new router: [130.146.22.1] 130.146.22.6
Specify alternate server list? (Y/[N]):
Selected values for subnetwork "130.146.59.0"
  net mask:                255.255.255.0
  no IP addresses offered
  auth server:             130.146.59.5
  firmware server:        130.146.59.5
  router:                  130.146.22.6
  alternate servers:
Accept as is? ([Y]/N):
### Building network tables - this will take a few minutes
### Configuring firmware version for Sun Ray
All the units served by "helios" on the 130.146.22.0
network interface, running firmware other than version
"2.0_37.b,REV=2002.12.19.07.46" will be upgraded at their
next power-on.
### Configuring Sun Ray Logging Functions
### stopped DHCP daemon
### started DHCP daemon
#
```

In this example, the default values initially suggested by `utadm` were not appropriate. Specifically, the default router address to be used by DTUs on this subnet was not correct because `utadm` guesses that the address of the default router for any shared subnet will have a host part equal to 1. This was a *great* guess for the directly-connected subnet B in FIGURE 7-2, but it is not correct for subnet C.

The appropriate router address for DTUs on this subnet is 130.146.22.6 (port 4 of router r22-59), so the administrator replied `n` to the first `Accept as is?` prompt and was given the opportunity to provide alternative values for the various parameters.

4. Restart Sun Ray services on the Sun Ray server.

Once the `utadm` command has completed, issue a `utrestart` command to fully activate Sun Ray services on the shared subnet:

```
# /opt/SUNWut/sbin/utrestart
Resetting servers... messages will be logged to /var/opt/SUNWut/log/messages.
```

Remote Shared Subnet: Example 2

In this example, deploying DTUs on subnet D in FIGURE 7-2, the answers to the three pre-deployment questions are:

1. From which DHCP server will DTUs on this subnet get their basic IP networking parameters?

From an external DHCP service.

2. From which DHCP server will DTUs on this subnet get additional configuration parameters to support features such as firmware download?

The DTUs will not be supplied with the additional parameters required to support firmware download or to activate other advanced DTU features.

3. How will DTUs on this subnet locate their Sun Ray server?

The external DHCP service will supply a single additional parameter to inform the DTU of the location of a Sun Ray server.

In this example, the Sun Ray server does not participate in DTU initialization at all. Why, then, are configuration steps required on the Sun Ray server? The Sun Ray server responds by default only to DTUs located on directly connected dedicated interconnects. It responds to DTUs on shared subnets only if the `utadm -L on` command has been executed. Running the `utadm -A subnet` command to activate DHCP on the Sun Ray server for a shared subnet, as in this example, implicitly executes `utadm -L on`. If `utadm -A subnet` has not been run, the administrator must run `utadm -L on` manually to allow the server to offer sessions to DTUs on the shared subnet.

1. Configure the External DHCP Service.

Determining how to configure the external DHCP infrastructure to provide basic networking parameters to the DTUs on this subnet is beyond the scope of this document. However, for this example, assume that DHCP service is provided by

Cisco IOS-based router r22-71 in FIGURE 7-2, attached to the 130.146.71.0 subnet through its 10/100 Ethernet port 3. This router can be configured to provide basic networking parameters and the location of a Sun Ray server as follows:

```
r22-71> interface fastethernet 3
r22-71> ip dhcp excluded-address 130.146.71.1 130.146.71.15
r22-71> ip dhcp pool CLIENT
r22-71/dhcp> import all
r22-71/dhcp> network 130.146.71.0 255.255.255.0
r22-71/dhcp> default-router 130.146.71.4
r22-71/dhcp> option 49 ip 130.146.59.5
r22-71/dhcp> lease 0 2
r22-71/dhcp> ^Z
r22-71>
```

Note – Details of the IOS interaction vary according to the specific release of IOS, the model of router and the hardware installed in the router.

DHCP option 49, the standard option of the *X Window Display Manager*, identifies 130.146.59.5 as the address of a Sun Ray server. In the absence of AltAuth and Auth-Srvr vendor-specific options, the DTU tries to find a Sun Ray server by broadcasting on the local subnet. If the broadcasts evoke no response, the DTU uses the address supplied in t option of the *X Window Display Manager*—provided that the DTU contains firmware at Sun Ray Server Software 2.0 patch level 114880-01 or later.

Note – This is an unorthodox use of the option of the *X Window Display Manager*, but in a remote subnet deployment where vendor-specific options can not be delivered, it may be the only way of putting a DTU in touch with a server.

2. Configure the Sun Ray server to accept DTU connections from shared subnets by running `utadm -L on`.

```
# /opt/SUNWut/sbin/utadm -L on
### Turning on Sun Ray LAN connection
NOTE: utrestart must be run before LAN connections will be allowed
#
```

3. Restart Sun Ray services on the Sun Ray server.

Once the `utadm` command has completed, issue a `utrestart` command to fully activate Sun Ray services on the shared subnet:

```
# /opt/SUNWut/sbin/utrestart
Resetting servers... messages will be logged to
/var/opt/SUNWut/log/
messages.
#
```

TABLE 7-2 lists the vendor-specific DHCP options that Sun Ray defines and uses.

TABLE 7-2 Vendor-specific DHCP Options

Parameter Name	Client Class	Option Code	Data Type	Optional/Mandatory	Granularity	Max Count	Comments
AltAuth	SUNW.NewT.SUNW	35	IP	Optional	1	0	List of Sun Ray server IP addresses
AuthSrvr	SUNW.NewT.SUNW	21	IP	Mandatory	1	1	Single Sun Ray server IP addresses
AuthPort	SUNW.NewT.SUNW	22	NUMBER	Optional	2	1	Sun Ray server port
NewTVer	SUNW.NewT.SUNW	23	ASCII	Optional	1	0	Desired firmware version
FWSrvr	SUNW.NewT.SUNW	31	IP	Optional	1	1	Firmware TFTP server IP address
BarrierLevel	SUNW.NewT.SUNW	36	NUMBER	Mandatory	4	1	Firmware Download: barrier level
LogHost	SUNW.NewT.SUNW	24	IP	Optional	1	1	Syslog server IP address
LogKern	SUNW.NewT.SUNW	25	NUMBER	Optional	1	1	Log level for kernel
LogNet	SUNW.NewT.SUNW	26	NUMBER	Optional	1	1	Log level for network
LogUSB	SUNW.NewT.SUNW	27	NUMBER	Optional	1	1	Log level for USB
LogVid	SUNW.NewT.SUNW	28	NUMBER	Optional	1	1	Log level for video
LogAppl	SUNW.NewT.SUNW	28	NUMBER	Optional	1	1	Sun Rat server interface name
Intf	SUNW.NewT.SUN	29	ASCII	Optional	1	0	Sun Ray server interface name
NewTBW		30	NUMBER	Optional	4	1	Bandwidth cap
NewTDispIdx	SUNW.NewT.SUNW	32	NUMBER	Optional	4	1	Obsolete. Do not use.
NewTFlags	SUNW.NewT.SUNW	34	NUMBER	Optional	4	1	Obsolete. Do not use.

The DTU can perform its basic functions even if none of these options are delivered during initialization, but some advanced DTU features do not become active unless certain options are delivered to the DTU. In particular:

- `AltAuth` and `AuthSrvr` indicate the IP addresses of Sun Ray servers. Addresses in the `AltAuth` list are tried in order until a connection is established. Current firmware ignores `AuthSrvr` if `AltAuth` is provided, but it is good practice always to specify `AuthSrvr` for the benefit of old (pre Sun Ray Server Software 1.3) firmware, which does not understand the `AltAuth` option. If neither of these

options is supplied, the DTU tries to locate a Sun Ray server by sending broadcasts on the local subnet. If the DTU contains firmware at Sun Ray Server Software 2.0 patch level 114880-01 or later, it resorts to trying to contact a Sun Ray server at the address supplied in the option of the `X Window Display Manager` if that option has been provided.

- `NewTVer` and `FWSrvr` must both be provided in order for the DTU to attempt a firmware download. `NewTVer` contains the name of the firmware version that the DTU should use. If this name does not match the name of the firmware version that the DTU is actually running, the DTU tries to download the desired firmware from a TFTP server at the address given by `FWSrvr`.
- `LogHost` must be specified in order for the DTU to report messages through the syslog protocol. Reporting thresholds for major DTU subsystems are controlled by the `LogKern`, `LogNet`, `LogUSB`, `LogVid`, and `LogApp1` options.

Note – The message formats, contents, and thresholds are intended for use only by service personnel and are not documented intentionally.

The DHCP Client Class name for all Sun Ray vendor-specific options is `SUNW.NewT.SUNW`. The DTU cites this name in DHCP requests so that the server can respond with the appropriate set of vendor-specific options. This mechanism guarantees that the DTU is not given vendor options defined for some other type of equipment and that other equipment is not given options that are meaningful only to the DTU.

Network Performance Requirements

This section describes the minimal network infrastructure needed to support a Sun Ray implementation.

Packet Loss

Before version 2.0, Sun Ray Server Software was intolerant of packet losses, so it was recommended that packet loss not exceed 0.1 percent over any extended period. However, because this is often an impractical requirement in local area (LAN) and wide area (WAN) network Sun Ray deployments, the Sun Ray Server Software has been made much more robust in the face of packet loss. The first version of this improved software was released with the first 2.0 patch, with additional improvements in releases supporting low-bandwidth WAN Sun Ray deployments.

In earlier versions, the server tried to avoid packet loss by severely limiting its use of available bandwidth whenever it encountered packet loss. Because random losses are inevitable in a non-dedicated LAN or WAN network environment, this approach put unnecessary limits on performance.

Sun Ray Server Software has always had the capability to detect and recover quickly from such losses, so avoiding them was a matter of policy more than necessity. The new software is less timid and avoids operating at bandwidth levels that create packet losses. Instead, it tries to send data at the highest possible rate that it can without incurring large losses. By design, it sometimes sends data at a rate that is too great for the capacity of the connection between the server and the client, and thus discovers what that capacity is. With very high demand, sustained packet losses of up to 10 percent may sometimes be seen, but the software continues to operate and update the contents of the screen correctly nevertheless.

Latency

Network latency between any Sun Ray client and its server is an important determinant of the quality of the user experience. The lower the latency, the better; latencies under 50 milliseconds for round trip delay are preferred. However, like familiar network protocols such as TCP, the Sun Ray DTU does tolerate higher latencies, but with degraded performance. Latencies up to 150 milliseconds provide usable, if somewhat sluggish, performance.

Out-of-Order Packets

DTUs that contain Sun Ray Server Software 2.0 firmware or later can tolerate small occurrences of out-of-order packet delivery, such as might be experienced on an Internet or wide-area intranet connection. Current Sun Ray firmware maintains a reordering queue that restores the correct order to packets when they are received out of order. In releases prior to Sun Ray Server Software 2.0, out-of-order packets were simply discarded.

Troubleshooting Tools

`utcapture`

The `utcapture` utility connects to the Sun Ray Authentication Manager and reports packet loss statistics and round-trip latency timings for each DTU connected to this server. See the `utcapture` man page to learn more about this command.

`utquery`

The `utquery` command interrogates a DTU and displays the DTUs initialization parameters along with the IP addresses of the DHCP services that supplied those parameters. It can be helpful in determining whether a DTU was able to obtain the parameters that were expected in a particular deployment and in determining specific DHCP servers that contributed to the DTUs initialization. See the `utquery` man page to learn more about this command.

OSD Icons

Sun Ray DTU on-screen display (OSD) icons contain information that can help the administrator understand and debug network configuration problems. The amount of information encoded into the icons has been significantly expanded in the firmware delivered with Sun Ray Server Software. The icon structure and progression are described in detail in Appendix .

Monitoring the Sun Ray System

This chapter describes how to use the Sun Management Center software to monitor the Sun Ray System. Installation instructions for the Sun Management Center are located in “Installing the SunMC Software” on page 49 of the *Sun Ray System Software 3 Installation and Configuration Guide*.

Topics include:

- “Sun Management Center (SunMC) Software Features” on page 135
- “Setting Up the Monitoring Environment” on page 137
- “Setting Monitoring Guidelines” on page 144
- “Using Other Monitoring Programs” on page 150
- “Removing the Sun Ray Module from SunMC” on page 152

Sun Management Center (SunMC) Software Features

The Sun™ Management Center software monitors managed objects in the Sun Ray system. A *managed object* is any object that can be monitored. Sun Ray nodes contain many managed objects. The Create Topology Object dialog box enables you to create a Sun Ray node. If the Sun Ray packages are installed when you create a Sun Ray node, the following managed objects are created by default:

- Sun Ray system
- Sun Ray services
- Failover group
- Interconnect
- Desktops

Each managed object is monitored separately and has independent alarm settings.

For example, in a failover configuration, the entire group as well as any part of the group can be monitored—each server and its load, each interconnect, and each DTU. Sun Management Center software also monitors Sun Ray Server Software daemons that:

- Authenticate users
- Start sessions
- Manage peripheral devices
- Handle DHCP services

After you set an alarm, the Sun Management Center software notifies you when your specified parameter value has been reached. For example, you might want to track the number of DTUs on a server so that you can monitor possible overload scenarios. Other alarms can be set to notify you when a server, interconnect, or DTU goes down or when a daemon is not running.

The three Sun Management Center components (TABLE 8-1) can be installed on three separate machines.

TABLE 8-1 Three Components of Sun Management Center Software

Component	Function
Console	Enables you to set and view alarms and to request system information. Requests can be automated or on demand.
Server	Processes requests and passes them on to the appropriate agent. The agent returns the requested information to the server, which then forwards it to the console.
Agents	Monitor the system. Agents return the requested information to the server. These agents, based on SNMP (Simple Network Management Protocol), monitor the status of the <i>managed object</i> (server, interface, or DTU).

Sun Ray system monitoring consists of ten packages, which are installed as part of Sun Ray Server Software. If you run the Sun Management Center on a non-Sun Ray server, you must add some packages that contain localized messages and icons to the Sun Management Center monitoring server.

This feature interfaces with the Sun Management Center software using SNMP. For information on additional monitoring programs that interact with Sun Management Center software, see “Using Other Monitoring Programs” on page 150.

Additional Sun Management Center Modules

There are other useful Sun Management Center modules available to monitor processes and help tune your Sun Ray system. For example, the Health Monitor module monitors resources on the Sun Ray server so you know when to add memory, swap space, or additional CPUs. The Sun Management Center Process Monitoring module helps identify runaway processes and limit multimedia applications.

Setting Up the Monitoring Environment

After installing the Sun Management Center software, you need to set up your monitoring environment. A default administrative domain is automatically created for you based on the Sun Management Center server component. You need to set a home administrative domain. This domain is displayed whenever the console is started. Next, create the hierarchy of the system you want to monitor. This can be done manually by adding nodes to the administrative domain or by using the Discovery Manager.

▼ To Set Up the Monitoring Environment

1. **After installing the Sun Management Center software, start the console on the server that has the console component installed:**

```
# /opt/SUNWsymon/sbin/es-start -c &
```

The login screen is displayed.

2. **Enter your user name and password.**
Specify the Sun Management Center server.
3. **Click Login.**

The Sun Management Center window is displayed. If this is your first time using the SunMC console, the Set Home Domain window is also displayed.

4. In the Set Home Domain window, highlight the appropriate domain and click Go To.

The panels in the Sun Management Center window are populated.

5. Click Close to dismiss the Set Home Domain window.

▼ To Create an Object

1. Expand the Sun Management Center Domains list.

2. Select the domain you plan to add an object to.

The selected domain is displayed.

3. Select Edit -> Create an Object.

The Create Topology Object pop-up window is displayed.

4. On the Node page, enter a Node Label and Description. Then enter the Hostname (server name), IP Address, and Port for the Sun Ray server.

The port entered here must be the same port you configured (entered) during the installation of the Sun Management Center.

Setting Alarms

Alarms are used to notify you when errors occur or your performance needs to be tuned. Alarms are triggered (tripped) if:

- A server goes down.
- An interconnect is no longer working.
- a DTU is down.

These alarms are set by default, but you can change them. Base a tuning alarm on the number of active sessions on each server in a failover group to determine if one of the servers is overloaded. You set the thresholds that trigger this type of alarm.

▼ To Set an Alarm

1. After creating an object, bring up the Details window of the object.

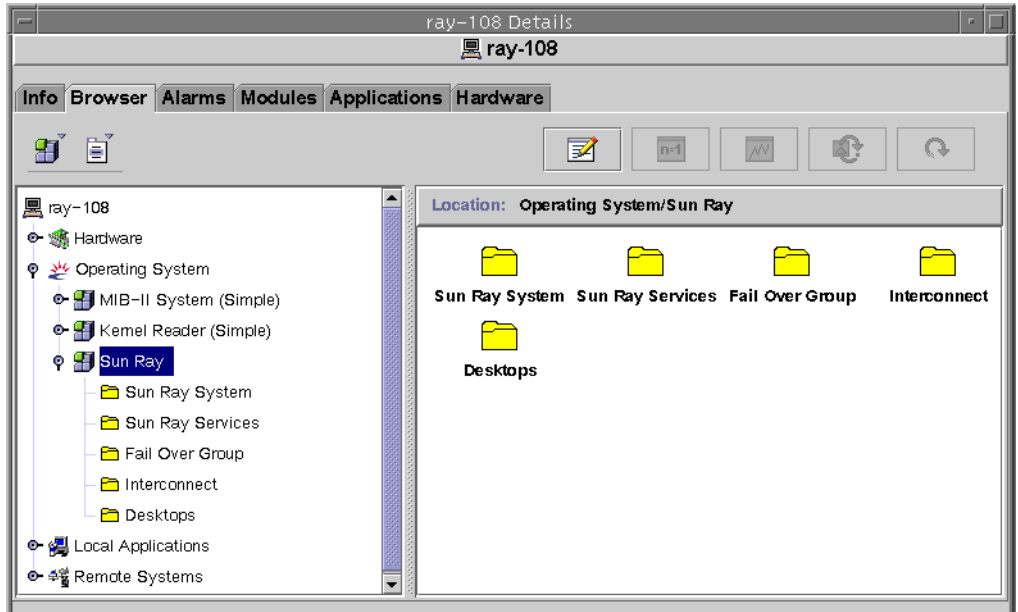

FIGURE 8-1 Sun Management Center Details Window

2. Double-click, for example, Failover Group in the left panel.
3. Right-click the value portion (Status) of the table row.

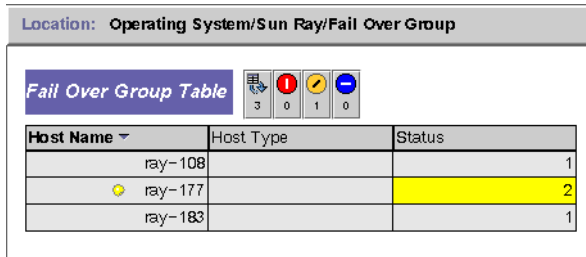

FIGURE 8-2 Example Using the Failover Group Panel

A pop-up menu is displayed.

4. Select Attribute Editor.
5. Select the Alarms tab (See FIGURE 8-3.)

The possible alarm values are:

- Critical Threshold (>)

- Alert Threshold (>)
- Caution Threshold (>)
- Critical Threshold (<)
- Alert Threshold (<)
- Caution Threshold (<)

6. Supply an appropriate number for the type of alarm that you choose to monitor.

In this example, the Alert Threshold alarm is set at greater than 1 to notify you when that server in the failover group is down.

7. Click the Apply button to save the value of the alarm and continue setting other values in the Attribute Editor

8. Click the OK button, which saves the value of the alarm and closes the window.

As soon as you set an alarm it takes effect.

9. Select the Actions tab and enter an action to perform.

Here you can also specify an action such as sending email or running a script for each alarm.

10. Select the Refresh tab to set the number of seconds between pollings.

The default value is 300 seconds (5 minutes).

11. Select the History tab to view information about the log file that records monitored values.



FIGURE 8-3 Alarm Window

If an alarm is tripped, a critical alarm displays as red, an alert alarm displays as yellow, and a caution displays as blue (see FIGURE 8-4).

▼ To Start Monitoring

1. **Start the Sun Management Center software:**

```
# /opt/SUNWsymon/sbin/es-start -c &
```

A window for the Default domain is displayed.

2. **Log in to the Sun management Center server.**
3. **Double-click the server in either panel.**
The server Details window is displayed.
4. **Expand the hierarchy in the left or right panel until it displays the level you want.**

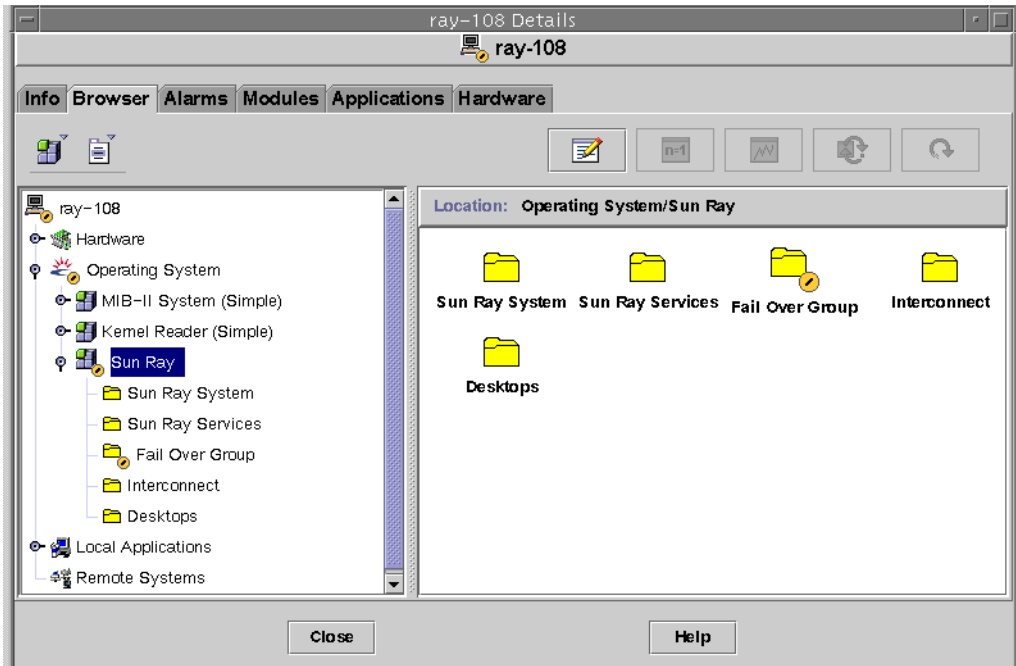

FIGURE 8-4 Details Window With Alarms

This console Details window shows the hierarchical details of your system. You can immediately see if any alarms have been tripped. An alarm's area and type appear in the left panel as a colored circle with a bar. The Alert alarm also shows up on the title bar by the server node name and at the Operating System, Sun Ray, and Failover Group levels. Double-clicking the area where an alarm icon is present updates the right panel with the detailed information. If you position the mouse pointer over one of the colored circles in either panel, a pop-up window is displayed detailing the alarm information.

If you click the Alarms tab in the Details window, a window is displayed that lists a summary of all the current alarms. When you stop the Sun Ray services (daemons), the alarms display as shown in FIGURE 8-5.

✓ 🚧 ↻ 📄

Last Refresh: Apr 05 16:56:01

Current Page: 1

Total Alarms for Object: 12

Severity	Start time	State	Action	Message
🔴	Apr 04 14:05:27	🔔	🚧	Sun Ray utsessiond Instances < 2
🔴	Apr 04 14:05:27	🔔	🚧	Sun Ray utdevmgrd Instances < 2
🔴	Apr 04 14:05:27	🔔	🚧	Sun Ray utseriald Instances < 2
🔴	Apr 04 14:05:27	🔔	🚧	Sun Ray Up Time (1/100ths sec.) Session Manager down
🔴	Apr 04 14:05:27	🔔	🚧	Sun Ray utparalleld Instances < 2
🟡	Apr 04 14:05:26	🔔	🚧	Sun Ray utauthd Status > 1
🟡	Apr 04 14:05:26	🔔	🚧	Sun Ray utsessiond Status > 1
🟡	Apr 04 14:05:26	🔔	🚧	Sun Ray utdevmgrd Status > 1
🟡	Apr 04 14:05:26	🔔	🚧	Sun Ray utseriald Status > 1
🟡	Apr 04 14:05:26	🔔	🚧	Sun Ray utparalleld Status > 1
🟡	Apr 04 14:05:26	🔔	🚧	Sun Ray in?2edhcpd Status > 1
🟡	Apr 04 14:05:26	🔔	🚧	Sun Ray rpc?2ebootparamd Status > 1

FIGURE 8-5 Alarm Summary Window

The total number of alarms set for the current server object is displayed at the top of the alarm summary window. Critical alarms (red), alert alarms (yellow), and caution alarms (blue) that are tripped are listed below. Details and comments are displayed in the Message column.

Some cells in the table respond to a mouse-over event by displaying a pop-up window called a *Tool Tip window*. This window shows the current status and when it last changed, plus the type of alarm, its value, and when it occurred or when the last alarm was cleared. The Tool Tip time can also be the last time the agent was restarted. For example, on the Sun Ray System panel, a Tool Tip for Up Time (1/100ths sec.) would be:

Clear. Up Time (1/100th sec.) OK Status changed Mar. 6, 15:23:55.

indicating that the server was restarted and the alarm cleared on March 6 at 15:23:55. Similar information is provided for Active Sessions, Desktops, Users, and Total Sessions.

Setting Monitoring Guidelines

There are five managed objects that you can monitor:

- Sun Ray System—Describes the Sun Ray server and load information
- Sun Ray Services—Describes the Sun Ray daemons on a Sun Ray server
- Failover Group—Lists all the servers in the group
- Interconnect—Lists all the interfaces on a Sun Ray server
- Desktops—Lists all monitored DTUs (desktops) and DTUs that have exceptions that are connected to a Sun Ray server

Sun Ray System Panel

The Sun Ray System panel displays an overview of your Sun Ray system. From this window you can set specific alarms to monitor the server and its load.

▼ To Display the Sun Ray System Panel

- Double-click the Sun Ray System icon in the left panel.

The Operating System/Sun Ray/Sun Ray System panel is populated.

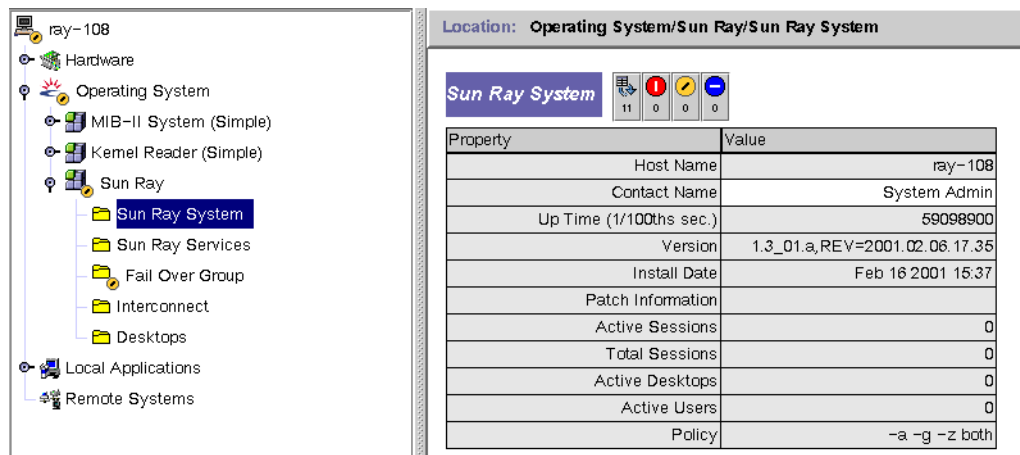

The screenshot shows a management console window. On the left is a tree view of system components. The 'Sun Ray System' folder is selected and highlighted in blue. The right pane displays the 'Sun Ray System' properties. At the top of the right pane, there is a title bar 'Location: Operating System/Sun Ray/Sun Ray System' and a toolbar with icons for help, refresh, stop, and a minus sign. Below the toolbar is a table with the following data:

Property	Value
Host Name	ray-108
Contact Name	System Admin
Up Time (1/100ths sec.)	59098900
Version	1.3_01.a,REV=2001.02.06.17.35
Install Date	Feb 16 2001 15:37
Patch Information	
Active Sessions	0
Total Sessions	0
Active Desktops	0
Active Users	0
Policy	-a -g -z both

FIGURE 8-6 Sun Ray System Panel

▼ To Refresh the Sun Ray System Panel

- **Click the refresh button (circular arrow in the upper right corner).**

The entire system panel is refreshed.

The Up Time, session, DTU (desktop), and user information is refreshed periodically based on the number of seconds you set in the Attribute Editor. However, the console is updated only every five minutes unless an alarm occurs. The number of seconds set in the Attribute Editor only changes how soon an alarm is triggered.

Tip – Do not set the seconds to less than 60. The load interferes with the Sun Ray server performance.

In this panel, you set alarms to monitor the status of the server; how many sessions, users, or DTUs are active; and how many total sessions exist.

▼ To Set Alarms

1. **Click the Value cell of the Property you want to set an alarm for with the right mouse button.**
2. **Select Attribute Editor.**
3. **Click the Alarms tab.**
4. **Enter a value for each threshold you want to monitor.**
5. **Click OK.**

TABLE 8-2 Properties on the Sun Ray System Panel

Property	Value
Host Name	Name of server that was queried. This information is obtained when Sun Ray System is selected or on manual refresh.
Contact Name	This information is obtained when Sun Ray System is selected or on manual refresh.
Up Time (1/100ths sec.)	Number of 1/100th seconds since the last of all the daemons critical to the Sun Ray server was started. A value of 0 means the server is down and an alarm is tripped. The default refresh rate is 300 seconds.
Version	List of version, build, and date of build of Sun Ray Server Software. This information is obtained when Sun Ray System is selected or on manual refresh.
Install Date	Date Sun Ray Server Software was installed. This information is obtained when Sun Ray System is selected or on manual refresh.

TABLE 8-2 Properties on the Sun Ray System Panel (Continued)

Property	Value
Patch Information	List of Sun-Ray-specific patches. This information is obtained when Sun Ray System is selected or on manual refresh.
Active Sessions	Number of sessions based on logged-in sessions with a smart card plugged in, plus sessions for DTUs logged in without smart cards. Set an alarm here to watch for overloading of this server. The default refresh rate is 300 seconds.
Total Sessions	Number of active and suspended sessions. The default refresh rate is 300 seconds.
Active Desktops	Number of connected DTUs. The default refresh rate is 300 seconds.
Active Users	Number of currently active users. When pseudo tokens are allowed (this is a policy setting), this number includes DTUs at the login prompt. The default refresh rate is 300 seconds.
Policy	The policy that has been set. This information is obtained when Sun Ray System is selected or on manual refresh.

Sun Ray Services Panel

The Sun Ray Services panel displays the status of the Sun Ray daemons. If, for example, `utauthd` is not running, all user sessions are disconnected.

On the Sun Ray Services panel, default alarm values are set for the status of each daemon and the number of instances. You can reset them if you want to.



Daemon	Status	Started Time	Last Changed	Instances	Description
in.dhcpd	1	1030644821	1030644821	1	DHCP daemon
rpc.bootparamd	1	1030480972	1030480972	1	Net boot parameter daemon
utauthd	1	1030481109	1030481109	1	Auth Manager
utdevmgrd	1	1030481108	1030481108	2	Device Manager
utdsd	1	1030480934	1030480934	1	Datastore daemon
utparallel	1	1030481108	1030481108	2	Parallel Device daemon
utscreeventd	2	0	0	0	Smartcard Manager
utseriald	1	1030481109	1030481109	2	Serial Device daemon
utsessiond	1	1030481108	1030481108	2	Session Manager

FIGURE 8-7 Sun Ray Services (daemons) Panel

The Status values are:

1. The daemon is running;

2. The daemon is down.

Some of the daemons have two instances, corresponding to their two functions: one to listen and one to interact.

Note – The `utscreventd` daemon does not run unless third-party Smart Card software is installed, so no alarm is triggered when the `utscreventd` status is 2.

Failover Group Panel

The Failover Group panel displays the topography of your failover group. The panel lists the primary and secondary servers and their status.

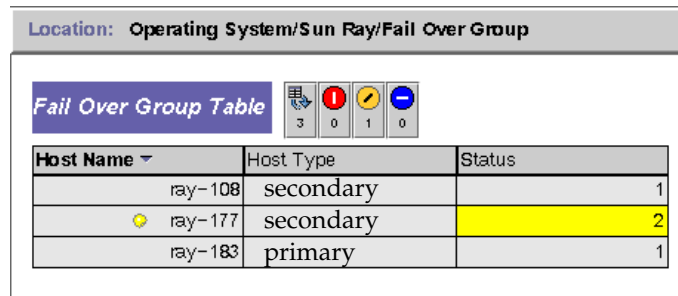

The screenshot shows a web interface for the Failover Group Panel. At the top, it indicates the location: "Operating System/Sun Ray/Fail Over Group". Below this is a title "Fail Over Group Table" and a set of four status icons with counts: a green icon with '3', a red icon with '0', a yellow icon with '1', and a blue icon with '0'. The main content is a table with three columns: Host Name, Host Type, and Status.

Host Name	Host Type	Status
ray-108	secondary	1
ray-177	secondary	2
ray-183	primary	1

FIGURE 8-8 Failover Group Panel

If the Status is 1, the server is running. If the Status is 2, the server is down and there is one Alert (yellow) alarm.

Interconnect Panel

The Interconnect panel lists all the network interfaces usable by the Sun Ray server.

Location: **Operating System/Sun Ray/Interconnect**

DHCP Table

Network Name	Available Addresses
SunRay-hme1	73

Interface Table

Entry Name	Status	Address	Netmask	Last Packet Seen (1/100ths sec)	Lan Type
hme0	1	192.9.116.108	255.255.255.0	1700	LAN
hme1	1	192.168.128.1	255.255.255.0	1700	

FIGURE 8-9 Interconnect Panel

The DHCP Table lists the interfaces that are used for the Sun Ray interconnect. Available Addresses lists the number of addresses available for new end users. The alarms that are set here let the system administrator know when the Sun Ray server is running out of addresses to give to users.

The Interface Table lists all the interfaces on the Sun Ray server. The Address is the IP address for the interface. You entered this address as the Net Mask when you first configured your system.

If the Status is 1, the interface is up. If the Status is 2, the interface is down.

▼ To Set an Alarm for Running Out of Addresses

1. Click the Available Addresses cell in the DHCP Table using the right mouse button.
2. Select Attribute Editor.
3. Click the Alarms tab.
4. Enter the number of addresses left when an alarm should be tripped.
5. Click OK.

Desktops Panel

The Desktops panel is where you can select individual DTUs to monitor. The possible values for the status of the DTUs are: 1, running; 2, down; and 3, displaying the green hourglass cursor. The default polling time is 300 seconds (5 minutes).

DTUs can be added and deleted from the Monitored Desktops list.

In a failover group, you can monitor any desktop from any server.

▼ To Add a DTU to Be Monitored

1. Click **Name** using the right mouse button.
A pop-up menu is displayed.
2. Click **Add Row**.
A pop-up window is displayed.
3. In the **Add Row** window, enter the MAC address of the DTU you want to monitor in the **Name** field.
4. Click **OK**.

▼ To Delete a DTU to Exclude Monitoring

1. Using the right mouse button, click the cell containing the MAC address.
A pop-up menu is displayed.
2. Click **Delete Row**.
A pop-up window is displayed.
3. Confirm the deletion by clicking **Yes** on the pop-up window.
Sample results of polling the Desktops are provided below.

The screenshot shows two tables from the Desktops Panel. The top table, 'Monitored Desktops', has a status of 3 (green hourglass) for the first row and 1 (yellow) for the second row. The bottom table, 'Desktop Exceptions', has a status of 3 (green hourglass) for the first row.

Monitored Desktops											
Name	IP Address	Status	Packets	Lost Packets	Lost Percent	Location	Optional Data	Server	Model	Firmware Revision	
080020b5...	192.168.128.17	3	0	0	0.0			nomad-100	SunRayP1	1.3_04.a,REV=20...	
080020cf...	192.168.128.16	1	0	0	0.0			nomad-100	SunRayP3	1.1_22b,REV=20...	

Desktop Exceptions											
Name	IP Address	Status	Packets	Lost Packets	Lost Percent	Location	Optional Data	Server	Model	Firmware Revision	
080020b5...	192.168.128.17	3	0	0	0.0			nomad-100	SunRayP1	1.3_04.a,REV=20...	

FIGURE 8-10 Desktops Panel

TABLE 8-3 describes the information in each column:

TABLE 8-3 Desktop Information

Property	Value
Name	Ethernet or MAC address of the DTU
IP Address	Assigned DHCP address of the DTU
Status	1 running, 2 down, and 3 displaying the green hourglass cursor
Packets	Number of packets received by the DTU
Lost Packets	Number of packets the DTU reported lost

TABLE 8-3 Desktop Information *(Continued)*

Property	Value
Lost Percent	Percentage of packets lost
Location	Optional field; information supplied by system administrator
Optional Data	Optional field; information supplied by system administrator
Server	Server that owns the DTU
Model	The type of DTU: SunrayP1 (Sun Ray 1), SunrayP2 (Sun Ray 100), or SunrayP3 (Sun Ray 150)
Firmware Revision	List of version, build, and build date

Using Other Monitoring Programs

System administrators using HP OpenView™VPO, Tivoli TMS, or CA Unicenter can also monitor Sun Ray servers. An interoperability interface exists between each of these packages and the Sun Management Center software. These interfaces translate Sun Management Center alarms appropriately so that you are notified when problems arise. These interfaces also enable you to view the server status. Hewlett-Packard provides the interface needed between HP OpenView™VPO and Sun Management Center. Sun provides the interface needed between Sun Management Center and Tivoli TMS or CA Unicenter.

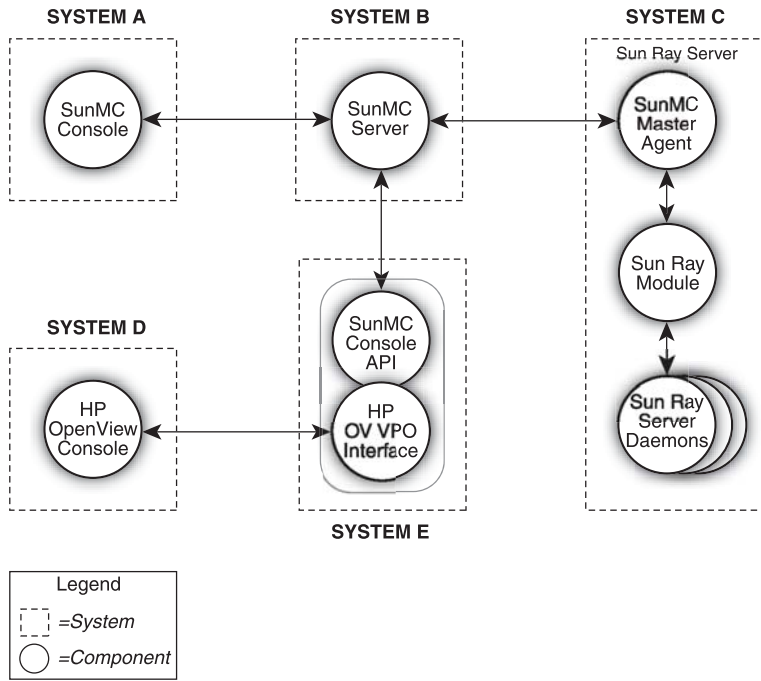

FIGURE 8-11 Example of Interoperability
(Systems B, C, and E must be Solaris SPARC systems)

Removing the Sun Ray Module from SunMC

The Sun Ray module is uninstalled automatically when the `utinstall` script uninstalls Sun Ray Server Software. If you are uninstalling the Sun management Center software manually, please remove the Sun Ray module first.

▼ To Remove the Sun Ray module

- To unregister the module on the Sun Ray server, type:

```
# /opt/SUNWut/sbin/utsummc -u
```

If the SunMC agent is running, `utsummc` stops and restarts the Sun Management Center agent software.

- To remove the Sun Ray module on the SunMC server, type:

```
# /opt/SUNWut/lib/utsumcinstall -u
```

Multihead Administration

The multihead feature on Sun Ray™ DTUs enables users to control separate applications on multiple screens, or *heads*, using a single keyboard and pointer device attached to the primary DTU. Users can also display and control a single application, such as a spreadsheet, on multiple screens. System administrators create multihead groups that may be accessed by users. A multihead group, consisting of between two and 16 DTUs controlled by one keyboard and mouse, may be composed of Sun Ray 1, Sun Ray 100, and Sun Ray 150 DTUs. Each DTU presents an X screen of the multihead X display.

Note – For the multihead feature to function properly:

1. You must be in administered mode; therefore, you must run `utconfig` before you run `utmhconfig` and `utmhadm`.
 2. You must enable the multihead policy using either `utpolicy` or the Admin GUI.
 3. Always run `utmhconfig` from a Sun Ray DTU.
-

By default, when the user logs into a multihead group, the user gets a multihead session using the number of screens available in that group. The resolution for the group is automatically set to the largest supported resolution of the primary DTU, which is the DTU that controls the other DTUs in the group and to which all peripherals are attached. Auto-size can be turned off and the Xserver size can be changed using the `utxconfig` command. Because auto-size affects X display dimensions as well as the initial multihead session group geometry, the user might experience panning or black-band effects.

The user can explicitly choose not to use multiple screens for a session by executing the `utxconfig -m off` command. The user can also choose a particular number of screens in a particular geometry by executing (in the following order):

- the `utxconfig -s off` command to disable autosize
- the `utxconfig -R geometry` command to have it take effect

When the user moves the mouse pointer past the edge between two screens, it moves from one screen to the next. The geometry of the multihead group determines which screen is displayed.

Multihead Groups

A multihead group is comprised of a set of associated Sun Ray DTUs controlled by a primary DTU to which a keyboard and pointer device, such as a mouse, are connected. This group, which can contain a maximum of 16 DTUs, is connected to a single session.

Unless XINERAMA is enabled (see “XINERAMA” on page 159 for more details), sessions will have a separate CDE toolbar (with separate workspaces) per screen. A window cannot be moved between screens.

The primary DTU hosts the input devices, such as a keyboard and a pointer device, and the USB devices associated with the session. The remaining DTUs, called the secondaries, provide the additional displays. All peripherals are attached to the primary DTU, and the group is controlled from the primary DTU.

Multihead groups can be created easily by using a smart card to identify the terminals with the `utmhconfig` GUI utility.

Tip – For best results, run `utmhconfig` only from a DTU.

However, if you disconnect the secondary DTUs without deleting the multihead group to which they belong, the screens are not displayed on the single primary DTU. The primary DTU is still part of the multihead group, and the mouse seems to get lost when it goes to the disconnected secondary DTU. To recover from this situation, you can either reconnect the missing DTU or delete the multihead group using the `utmhconfig` or `utmhadm` command, or you can delete the multihead group, replace the missing DTU, and create a new multihead group that incorporates the replacement DTU.

Multihead Screen Display

When the multihead feature is used, a small window indicating the current session on each screen is displayed with the current screen highlighted for easy identification. This window is automatically displayed for users during session creation. For example, the display in “XINERAMA” on page 159 indicates that the user is on the second screen of a three-screen display.



FIGURE 9-1 The Multihead Screen Display

Display Resolution

To avoid panning, all the monitors in a workgroup must support the same resolution.

The auto-size feature sets the user's X server display dimensions automatically to match the preferred resolution supported by the primary DTU when the session is created. This resolution will be the optimum resolution for the multihead group. This feature can be turned off and on using the `utxconfig` command. The default geometry, which is the number of rows and columns in the multihead group, and the screen order are also automatically set when a session is created. This feature can be turned off and on using the `utxconfig` command.

If auto-size is on when you create a session on a 2x1 multihead group, the result is a 2x1 session. If auto-size is turned off, the size of the session is whatever you designate. For instance, if auto-size is off and the geometry is set to 3x1, then even if you log in to a 2x1 multihead group (or even a non-multihead, 1x1 terminal), you will get a 3x1 session with screen flipping. This might be useful if you know you are going to hot desk to a 3x1 multihead group in the future and want to take full advantage of it when you get there.

Note – If the resolutions of the monitors differ, you may have problems with unwanted on-screen movement called *panning*, or large *black bands* around the visible screen area.

Multihead Administration Tool

The administration tool for the multihead feature displays the current multihead groups and enables you to create new groups.

▼ To Turn On Multihead Policy From the Command Line

- On the command-line interface, type:

```
# /opt/SUNWut/sbin/utpolicy -a -m -g your_policy_flags
# /opt/SUNWut/sbin/utrestart
```

This enables the multihead policy for the failover group and restarts Sun Ray Server Software with the new policy on the local server without disrupting existing sessions.

Tip – Issue the `utrestart` command on every server in the failover group.

▼ To Turn On Multihead Policy Using the Administration Tool

1. Bring up the Administration Tool by typing the following URL into your browser's location field:

```
http://hostname:1660
```

2. Select Admin from the navigation menu on the left side of the tool.
3. Select Policy.
4. Next to Multihead feature enabled, click the Yes radio button.
5. Click the Apply button.
6. Under Admin in the lefthand menu, select Reset Services.
7. Click the Restart button.

This sets the multihead policy for all servers and restarts Sun Ray Server Software on all servers.

▼ To Create a New Multihead Group

1. On the command-line interface, type:

```
# /opt/SUNWut/sbin/utmhconfig
```

2. On the initial screen, click Create New Group.

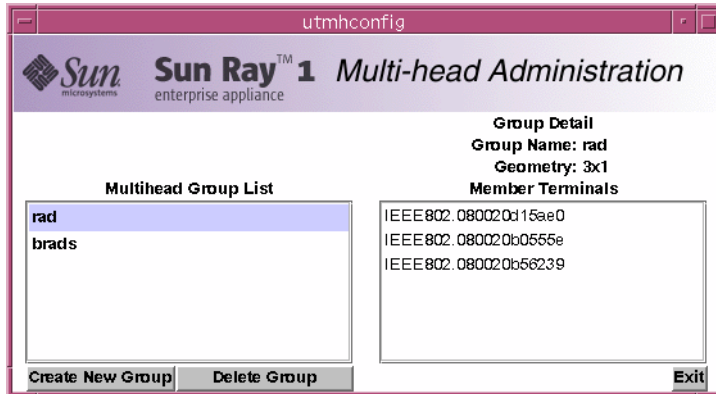

FIGURE 9-2 Multihead Group List With Group Detail

The Create New Multiheaded Group pop-up dialog box is displayed. The number of rows and the number of columns you enter are displayed as the group geometry when the group has been created.

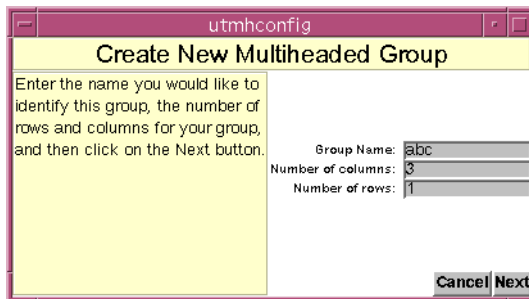

FIGURE 9-3 Create New Multiheaded Group Pop-up Dialog Box

3. Enter the information for the group.

Enter a name for the group and the number of rows and columns.

4. Click the Next button.

A third screen is displayed.

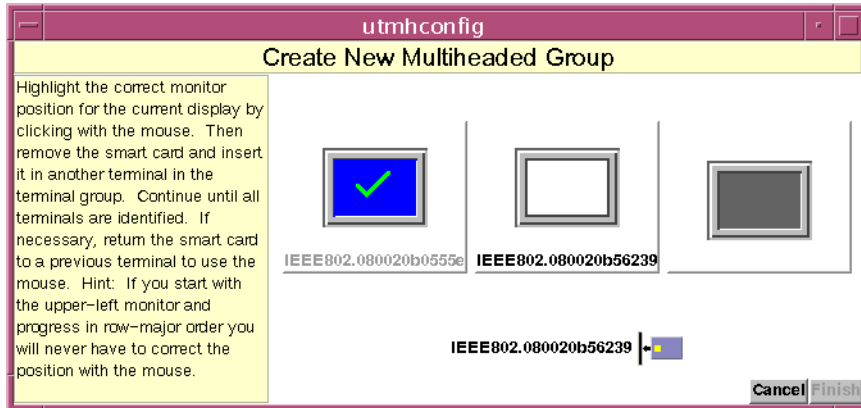

FIGURE 9-4 Setup Display for the New Multihead Group

5. **Select the DTUs within the multihead group and insert a smart card in each Sun Ray DTU in turn to establish the order of the group.**

The Finish button, which was previously grayed out, is now active.

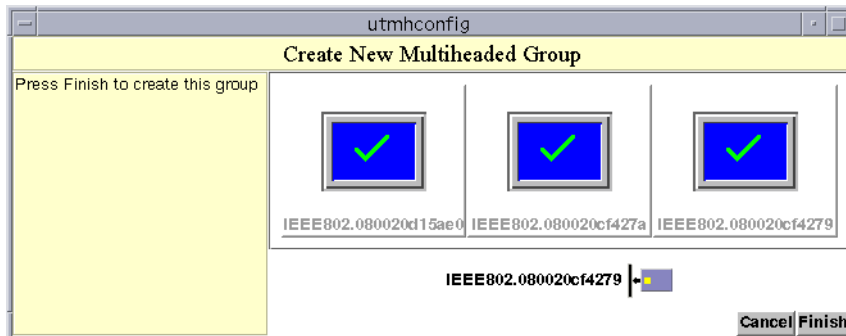

FIGURE 9-5 Completed Multihead Group List With Active Finish Button

6. **Click the Finish button.**
7. **Exit the session or disconnect by removing your card.**

XINERAMA

The XINERAMA extension to X11 creates one single large screen displayed across several monitors. With XINERAMA only one toolbar is displayed, and a window can be moved smoothly from one part of the screen to the next. XINERAMA is supported in both the Solaris 8 and Solaris 9 operating environments.

A single CDE toolbar (and set of workspaces) manages the configured monitors. A window can span monitors, since they are still within the same screen. This includes the CDE toolbar itself.

Tip – Because XINERAMA consumes a lot of CPU, memory and network bandwidth, please set the `shmsys:shminfo_shmmax` parameter in the `/etc/system` file to at least $LARGEST_NUMBER_OF_HEADS * width * height * 4$ for reasonable performance.

Users enable or disable XINERAMA as part of their X preferences. The `utxconfig` command handles this on an individual token basis. The user must log off for this to take effect.

The XINERAMA feature is enabled using the following command:

```
% /opt/SUNWut/bin/utxconfig -x on
```

The XINERAMA feature is disabled using the following command:

```
% /opt/SUNWut/bin/utxconfig -x off
```

To enable as default for a single system or failover group, as superuser, type the following command:

```
% utxconfig -a -x on
```

Session Groups

If you hot desk from a multihead group to a DTU that is not part of a multihead group—that is, a DTU with a single head—all the screens created in the original multihead group can be viewed on the single screen or head by panning to each screen in turn. This is called *screen flipping*.

Authentication Manager

The TerminalGroup policy module extends the Authentication Manager to support multihead groups. When a DTU connects to the Authentication Manager or a new smart card is inserted, the TerminalGroup module queries its database to determine whether the DTU is part of a multihead group and, if so, whether the DTU is a primary or secondary DTU of that group. If it is not identified as part of a multihead group, the DTU is treated normally.

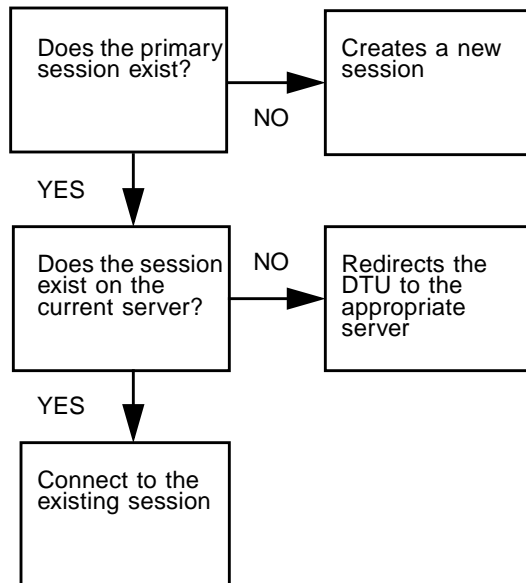

This flow chart asks the following questions:

FIGURE 9-6 Authentication Manager Flowchart for the Primary DTU

If the DTU is determined to be part of a multihead group and it is the multihead group's primary DTU, a normal session placement occurs. If a session does not exist on the current server, but there is a preexisting session for the DTU or smart card on another server in the failover group, the primary DTU will be redirected to that server. If there is no session on any server, the request for a session is directed to the least-loaded server and a session is created there.

If a DTU is determined to be part of a multihead group and it is a multihead group secondary DTU, the TerminalGroup module determines if the multihead- group primary DTU is locally attached to a session. If it is, it tells the Session Manager to allow the secondary DTU to also attach to that session. If the primary DTU is not attached locally, the TerminalGroup module determines if the primary DTU is attached to another server in the failover group (if any), and if it is, it redirects the secondary DTU to that server.

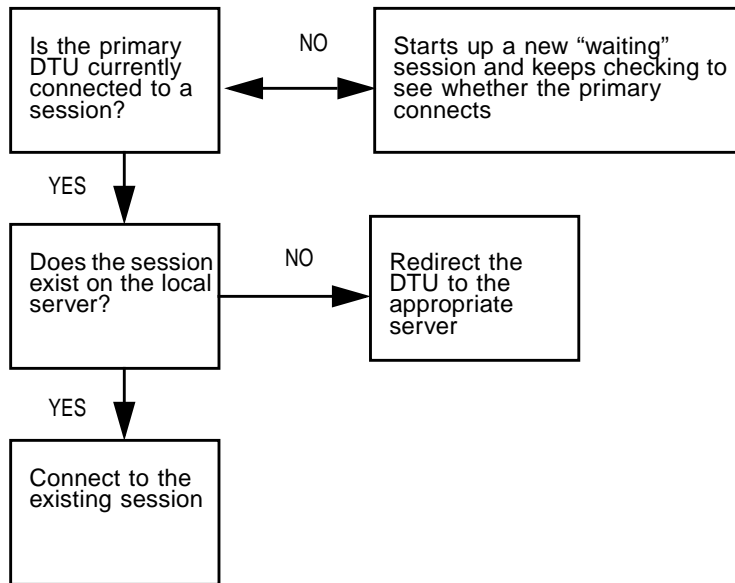

FIGURE 9-7 Authentication Manager Flowchart for the Secondary DTU

If the primary DTU is determined to not be attached to any server in the failover group at that moment, a "waiting for primary" icon is displayed on the DTU, and further activity is blocked on that DTU until the primary is discovered. The secondary DTU is redirected to the server to which the primary is attached.

Controlled Access Mode

This chapter describes Controlled Access Mode (CAM) as well as how to deploy, install, and configure your system to allow controlled, simplified access to anonymous users without compromising the Sun Ray server's security. Controlled Access Mode was formerly called Kiosk Mode.

Topics include:

- "Controlled Access Mode Functionality" on page 163
- "Advanced Application Setup" on page 171
- "Security and the Controlled Access Mode Environment" on page 174

Controlled Access Mode Functionality

The Sun Ray system is well-suited to host a CAM application, such as public terminals in an airport. In CAM, a user accesses only specified applications. The user does not need to pass security to log in or to use a smart card.

Enabling Controlled Access Mode

The CAM feature is administered through the Sun Ray Administration Tool or through the Command-line Interface (CLI).

CAM is a policy decision that affects system-level operations. Turn controlled access mode on and off in the Change Policy section of the Admin function of the Administration Tool. You can enable the CAM Policy option for smart card users, non-smart card users, or both.

When controlled access mode is turned on, `kiosk.start` uses scripts to choose temporary users and home directories, then uses the `kiosk.conf` file to configure and populate the user's environment and to launch enabled applications. When a session terminates, `kiosk.start` cleans up all the files and entries related to the session, then recreates the environment for a new user.

Tip – To enable CAM, use `utconfig`.

▼ To Enable Controlled Access Mode with the Admin GUI

1. Start the Administration Tool.
2. Select the arrow to the left of **Admin** to expand the navigation menu.
3. Click the **Policy** link.
4. For smart card users, select the **Controlled Access Mode** check box in the **Card Users** column.

All smart card users get a Controlled Access Mode session.

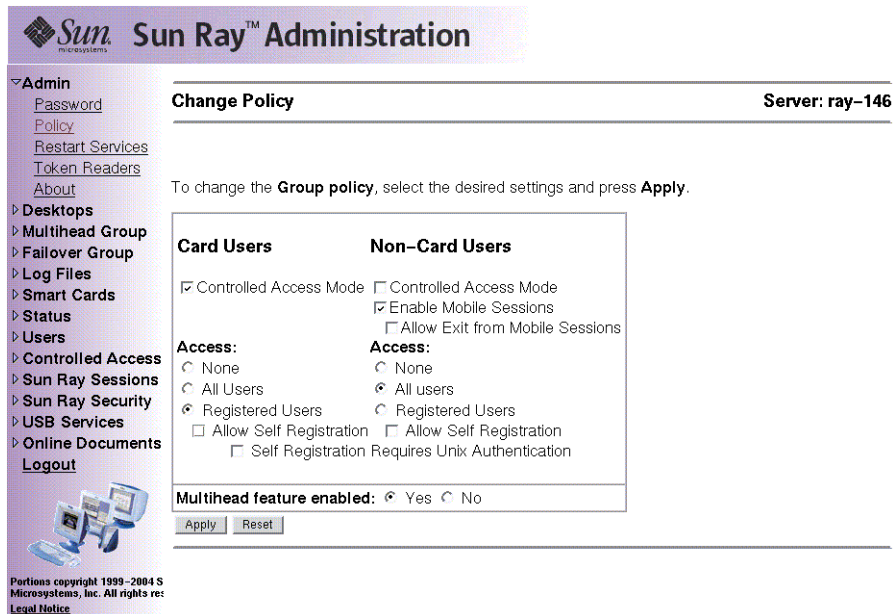

FIGURE 10-1 Change Policy Window

5. For non-smart card users, select the **Controlled Access Mode** check box in the **Non-Card Users** column.

6. Click the Apply button.
7. Select the Restart Services option in the Admin menu.
8. Under Scope, click the Local or Group radio button, depending on the failover scenario.
9. Click the Cold Restart button.

▼ To Configure CAM Settings

1. Click the arrow to the left of Controlled Access Mode in the navigation menu.
2. Click the Settings link.

This panel is where the action parameters are set for the Controlled Access Mode. The values define how a session is managed.

3. Click the Submit Changes button to store the action parameters in the `/var/opt/SUNWut/kiosk/kiosk.conf` file, which is the controlled access mode configuration file.

The Controlled Access Mode Configuration panel is displayed.

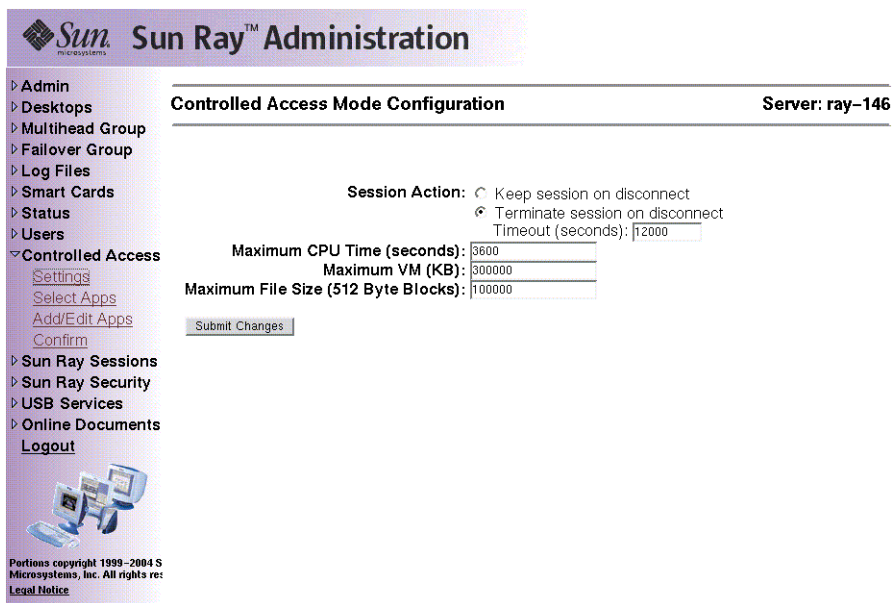

FIGURE 10-2 Controlled Access Mode Configuration Panel

The default settings for each controlled access mode session can be edited from this panel. The Session Action option determines whether sessions remain resident after having been disconnected. If you choose the option to kill the session (the default), the Timeout text box value determines how long to wait before killing the session.

The default values in the maximum CPU, VM, and File Size text boxes are set with the `ulimit` command. These limits contain the CAM user processes.

4. Click the **Confirm** link in the navigation menu to save the changes.
5. Click the **Confirm Configuration** button.
6. Click the arrow to the left of **Admin** to expand the navigation menu.
7. Click the **Reset Services** link.
8. Select the **Local** or **Group** radio button, depending on the failover scenario.

▼ To Configure CAM Using the CLI

- As superuser, type the `utpolicy` command for your authentication policy with the addition of the `-k` argument. For example:

```
# /opt/SUNWut/sbin/utpolicy -a -M -s both -r both -k both
```

Building the Controlled Access Mode Environment

When CAM is enabled, `dtsession` is launched by default to provide basic Controlled Access Mode functionality; however, you may choose to use a different window manager. Additional applications need to be added to the user's session to extend this basic functionality. Possible applications include:

- Browser
- Clock
- Calculator
- Custom application

Tip – Complete your additions and edits in the Add/Edit Apps section and your selections in the Select Applications section before clicking the Confirm link.

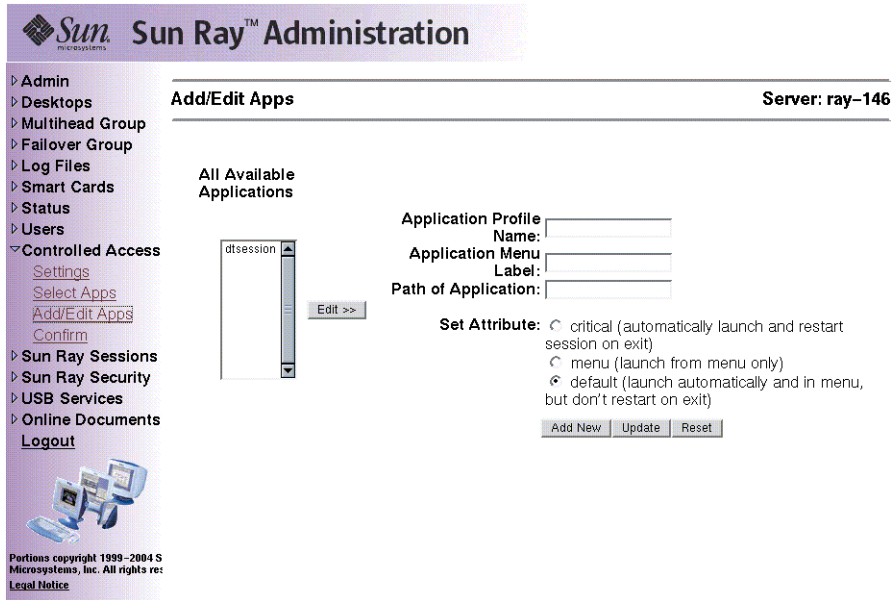

FIGURE 10-3 Add/Edit Apps Panel

▼ To Add a New Application

1. **Click the Add/Edit Applications link from the Controlled Access Mode menu.**
The Add/Edit Apps window is displayed.
2. **Enter a profile name, a menu label, and a path to the application.**
In the Path of Application text field:
 - List the full path with command-line options or
 - Point to a script that you want to run at session start up (see “Advanced Application Setup” on page 171)
3. **Set the application behavior by clicking one of the radio buttons.**
4. **Click the Add New button.**
The new application is added to the Available Applications list.
5. **Click the Confirm link.**
The confirm panel is displayed.
6. **Click the Confirm Configuration button.**

The Confirm link sends `kiosk.conf` information to the internal Sun Ray database. This information is then replicated to the failover group. After defining a user's session by writing the `kiosk.conf` file, you must restart failover services to propagate the configuration to all the servers in a failover group.

7. **To enable the newly added application, go to the Select Applications panel and add the application to the Applications to Launch list.**

All applications must be accessible to all servers in the failover group. Add new applications to all servers in a failover group.

▼ To Edit an Available Application

1. **Click the Add/Edit Applications link from the Controlled Access Mode menu.**

The Add/Edit Apps window is displayed.

2. **Highlight the application in the All Available Applications list that you want to change and click the Edit button.**

The fields on the right are populated. If, for example, you want to change a default application to be a critical application, you must edit the application and change the attribute to critical.

3. **Make the changes and click the Update button.**

The application information is updated.

Note – You cannot change the Application Profile Name.

4. **Click the Confirm link.**

The confirm panel is displayed.

5. **Click the Confirm Configuration button.**

Note – You cannot edit `dtsession`.

6. **If the application is enabled, click the Reset Services link in the Admin menu.**

7. **Click the Restart button.**

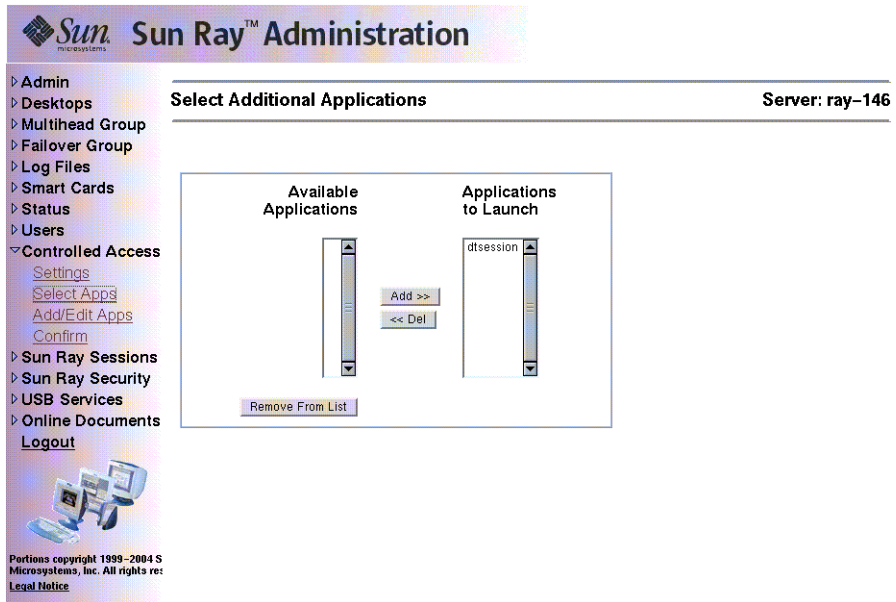

FIGURE 10-4 Additional Applications Configuration Panel

▼ To Make an Application Available to Users

1. Choose Select Applications from the Controlled Access Mode menu.

This panel lists the other applications that are available for the user's sessions. In FIGURE 10-4, there are default applications and two possible additional applications you can make available to the user.

2. In the Available Applications column, highlight the application that you plan to add.

3. Click the Add button to add it to the Applications to Launch column.

4. Click the Confirm link.

The confirm panel is displayed.

5. Click the Confirm Configuration button.

6. Under the Admin menu, click the Reset Services link.

7. Click the Restart button.

▼ To Make an Application Not Available to Users

1. From the Controlled Access Mode menu, click the Select Applications link.

2. **In the Applications to Launch list, highlight the application that you want to make unavailable.**
3. **Click the Del button.**
This moves the application back to the Available Applications list.
4. **Click the Confirm link.**
The confirm panel is displayed.
5. **Click the Confirm Configuration button.**
6. **Under the Admin menu, click the Reset Services link.**
7. **Click the Restart button.**

▼ To Remove an Application

1. **From the Controlled Access Mode menu, click the Select Applications link.**
2. **In the Available Applications list, highlight the application that you want to remove.**
3. **Click the Remove From List button.**
This completely removes the application.
4. **Click the Confirm link.**
The confirm panel is displayed.
5. **Click the Confirm Configuration button.**

Advanced Application Setup

To customize the CAM user's environment further, you can use prototypes or wrapper scripts to enhance application behavior. Prototypes enhance application behavior by providing files in the user's home directory specific to that application.

Note – Prototypes must be duplicated on each server in a failover group.

Enabling Prototypes

Note – When you add new applications, the name of the prototype directory must match the name in the Application Profile Name field of the Administration Tool.

▼ To Enable Prototypes

1. Create a directory with the same name as the application profile name provided in the Add/Edit Applications section of the Administration Tool:

```
/var/opt/SUNWut/kiosk/prototypes/application_profile_name
```

2. Populate the new prototype directory with files specific to that application:

```
files/directories to be copied into the user's home directory
```

If the application is enabled, everything below the prototype directory is copied recursively to each user's home directory at runtime by the Controlled Access Mode startup scripts. For example, at runtime, there is a `dtsession` prototype directory that matches the application profile name, `dtsession`.

- The application name is `dtsession`.
- The prototype directory is
`/var/opt/SUNWut/kiosk/prototypes/dtsession`.
- The prototype directories and files are
`/var/opt/SUNWut/kiosk/prototypes/dtsession/.dt`
- The files and directories at the `.dt` level are copied to the user's home directory (`/HOME/user1/.dt`) at runtime.

Using Wrapper Scripts to Customize Controlled Access Mode Applications

If an application requires specific environment variables to be set or if you need to launch the application instead of simply providing the path to the application with options, you can use a wrapper script.

▼ To Launch an Application Using a Wrapper Script

- When you add the application using the Administration Tool, provide the path to the wrapper script instead of a path to the executable:

```
/opt/SUNWut/kiosk/bin/dtsession
```

This example wrapper script customizes the right-click menu button to reflect application labels for menu or default-attributed applications. The script then launches `dtsession`.

- Alternatively, put the wrapper script in the directory where the Controlled Access Mode program checks for wrapper scripts:

```
/opt/SUNWut/kiosk/wrappers
```

In this case, the wrapper scripts must have the same name as the path of the application entered in the Add/Edit Applications tab. For an example of a wrapper script, refer to `ControlledBrowser`, which is installed when `cbinstall` is executed. The `cbinstall` script is found in the Supplemental directory on the CD-ROM, in the `/opt/SUNWut/kiosk/wrappers` directory.

Note – Wrapper scripts in `/opt/SUNWut/kiosk/wrappers` are sourced rather than executed. Any wrapper script you put in this directory must set `waitPIDs`.

Modifying CAM User Displays

Customers may want to set up their CAM displays to emulate their own corporate logos or other display artifacts. The following procedures suggest how to modify the CAM display.

▼ To Change the Backdrop

1. Run `xv` (version 3.10 or later) on any desired image.
2. Save the file as "XPM". Rename the file from `<>.xpm` to `<>.pm`.
3. Edit the file `/opt/SUNWut/kiosk/prototypes/dtsession/Dtwm` and change the two backdrop lines to the full pathname of the `<>.pm` file.

You can also place the `<>.pm` file in `/usr/dt/share/backdrops` and then refer to it by `<>` in the `Dtwm` file.

Note – For your personal CDE workspace, you can save this file in `$HOME/.dt/backdrops`, log out and back in, then set your workspace backdrop to `NoBackdrop` using style manager.

▼ To Change the CDE Menu

The menu is created from three files in `/opt/SUNWut/kiosk/bin`:

```
kiosk.menu
dtwmrc.header
dtwmrc.footer
```

It uses `/usr/dt/config/$LANG/sys.dtwmrc` where `$LANG` most likely = "C" as a base.

1. Copy this file up to the local directory.
2. Change the `kiosk.menu` script to use your modified file for further tweaks.

`kiosk.menu` puts the final menu product together, and adds in the applications that are selected in the CAM configuration.

▼ To Activate Debugging

- Edit the file `/var/opt/SUNWut/kiosk/kiosk.conf`.

This creates a debug file `/var/tmp/kiosk.$PID`.

Note – This file gets reset, however, when the services are reset; the debugging output may be rather weak.

Security and the Controlled Access Mode Environment

Since Controlled Access Mode bypasses a login mechanism, you must consider the security of the applications added to the user environment. Many custom applications provide built-in security while other applications do not and, therefore, are not suitable for Controlled Access Mode.

For example, adding an application, such as `xterm`, provides users with access to a command-line interface from a Controlled Access Mode session. This would not be desirable in a public environment and is not advised. However, using a custom application for a call center would be an ideal situation. See Appendix A for an example of an application modified for Controlled Access Mode.

Failover

In a failover environment, the administrative settings in the `kiosk.conf` file are copied to the failover servers. Be sure that all application paths added to the Controlled Access Mode sessions are copied across the servers in the failover group. For example, if the Netscape application is added to the sessions with the executable path, `/usr/local/exe/netscape`, make sure that the path to the binary is available to all servers in the failover group.

Note – Applications must be installed in the same location and set up the same way on each server in the failover group. Prototypes and wrapper scripts must also exist on each server in the failover group.

Localization

Controlled Access Mode sessions use their server's default locale.

▼ To Change the Locale for Controlled Access Mode Sessions Without Changing the System Locale

- Add the following line to the end of the `/etc/default/init` file:

```
LANG=new-locale
```

The new locale is used by the Controlled Access Mode sessions.

Note – Adding this line changes the locale for all users on this server.

Failover Groups

Sun Ray servers configured in a failover group provide users with a high level of availability when one of those servers becomes unavailable because of a network or system failure. This chapter describes how to configure failover groups.

This chapter covers these topics:

- “Failover Group Overview” on page 178
- “Setting Up IP Addressing” on page 180
- “Group Manager” on page 186
- “Load Balancing” on page 188
- “Setting Up a Failover Group” on page 188
- “Viewing the Administration Status” on page 190
- “Viewing Failover Group Status” on page 191
- “Recovery Issues and Procedures” on page 192
- “Setting Up a Group Signature” on page 195
- “Taking Servers Offline” on page 196

Failover Group Overview

A failover group consists of two or more Sun Ray servers grouped together to provide highly-available and scalable Sun Ray service for a population of Sun Ray DTUs. Releases earlier than 2.0 supported DTUs available to the servers only on a common, dedicated interconnect. Beginning with the 2.0 release, this capability was expanded to allow access across the LAN to either local or remote Sun Ray devices. However, there is still a requirement for the servers in a failover group to be able to reach one another, using multicast or broadcast, over at least one shared subnet. Servers in a group authenticate (or “trust”) one another using a common group signature. The group signature is a key used to sign messages sent between servers in the group; it must be configured to be identical on each server.

Failover groups that use more than one version of Sun Ray Server Software will be unable to use all the features provided in the 2.0 and 3 releases. On the other hand, the failover group can be a heterogeneous group of Sun servers (for example, a mixture of E250s and E450s) running various releases of the Solaris operating environment, such as Solaris 8 and Solaris 9.

When a dedicated interconnect is used, all servers in the failover group should have access to, and be accessible by, all the Sun Ray DTUs on a given sub-net. The failover environment supports the same interconnect topologies that are supported by a single-server Sun Ray environment. However, switches should be multicast-enabled.

FIGURE 11-1 illustrates a typical Sun Ray failover group. For an example of a redundant failover group, see FIGURE 11-2.

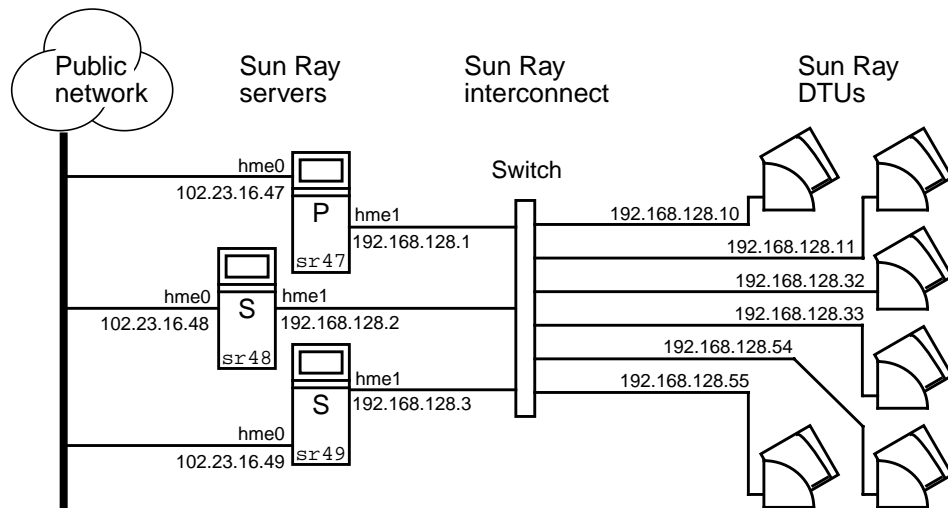

FIGURE 11-1 Simple Failover Group

When a server in a failover group fails for any reason, each Sun Ray DTU connected to that server reconnects to another server in the same failover group. The failover occurs at the user authentication level; the DTU connects to a previously existing session for the user's token. If there is no existing session, the DTU connects to a server selected by the load-balancing algorithm. This server then presents a login screen to the user and the user must relogin to create a new session. The state of the session on the failed server is lost.

The principal components needed to implement failover are:

- Group Manager—A module that monitors the availability (liveness) of the Sun Ray servers and facilitates redirection when needed.
- Multiple, coexisting Dynamic Host Configuration Protocol (DHCP) servers—All DHCP servers configured to assign IP addresses to Sun Ray DTUs have a non-overlapping subset of the available address pool.

Note – The failover feature cannot work properly if the IP addresses and DHCP configuration data are not set up properly when the interfaces are configured. In particular, if the Sun Ray server's interconnect IP address is a duplicate of any other server's interconnect IP address, the Sun Ray Authentication Manager throws "Out of Memory" errors.

The redundant failover group illustrated in FIGURE 11-2 can provide maximum resources to a few Sun Ray DTUs. The server `sr47` is the primary Sun Ray server and `sr48` is the secondary Sun Ray server; other secondary servers (`sr49`, `sr50` . . . are not shown.

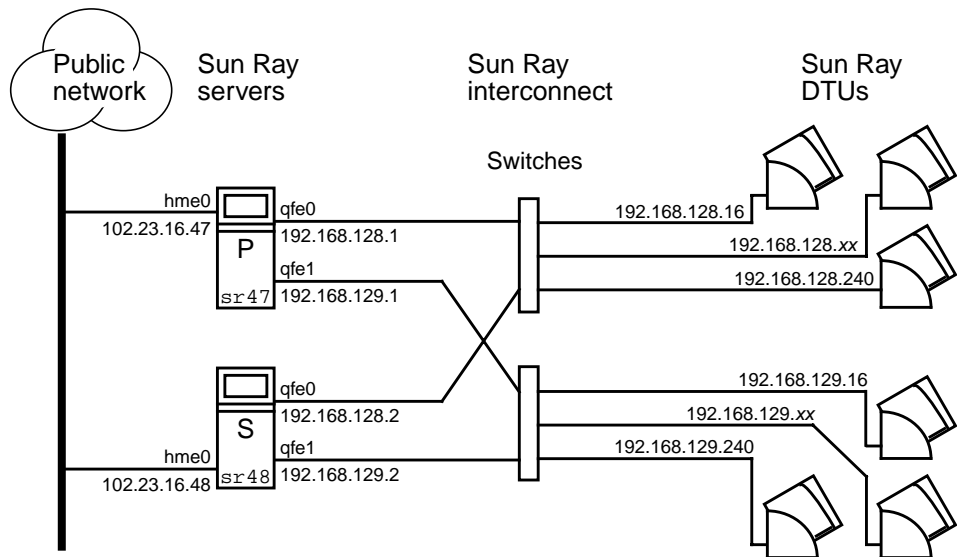

FIGURE 11-2 Redundant Failover Group

Setting Up IP Addressing

The `utadm` command assists you in setting up a DHCP server. The default DHCP setup configures each interface for 225 hosts and uses private network addresses for the Sun Ray interconnect. For more information on using the `utadm` command, see the man page for `utadm`.

Before setting up IP addressing, you must decide upon an addressing scheme. The following examples discuss setting up class C and class B addresses.

Setting Up Server and Client Addresses

The loss of a server usually implies the loss of its DHCP service and its allocation of IP addresses. Therefore, more DHCP addresses must be available from the address pool than there are Sun Ray DTUs. Consider the situation of 5 servers and 100 DTUs. If one of the servers fails, the remaining DHCP servers must have enough available addresses so that all “orphaned” DTUs get a new working address.

TABLE 11-1 describes how to configure five servers for 100 DTUs, accommodating the failure of two servers (class C) or four servers (class B).

TABLE 11-1 Configuring Five Servers for 100 DTUs

Servers	Class C (2 Servers Fail)		Class B (4 Servers Fail)	
	Interface Address	DTU Address Range	Interface Address	DTU Address Range
serverA	192.168.128.1	192.168.128.16 to 192.168.128.49	192.168.128.1	192.168.128.16 to 192.168.128.116
serverB	192.168.128.2	192.168.128.50 to 192.168.128.83	192.168.129.1	192.168.129.16 to 192.168.129.116
serverC	192.168.128.3	192.168.128.84 to 192.168.128.117	192.168.130.1	192.168.130.16 to 192.168.130.116
serverD	192.168.128.4	192.168.128.118 to 192.168.128.151	192.168.131.1	192.168.131.16 to 192.168.131.116
serverE	192.168.128.5	192.168.128.152 to 192.168.128.185	192.168.132.1	192.168.132.16 to 192.168.132.116

The formula for address allocation is: address range (AR) = number of DTUs/(total servers - failed servers). For example, in the case of the loss of two servers, each DHCP server must be given a range of $100/(5-2) = 34$ addresses.

Ideally, each server would have an address for each DTU. This would require a class B network. Consider these conditions:

- If AR multiplied by the total number of servers is *less than or equal to 225*, configure for a class C network
- If AR multiplied by the total number of servers is *greater than 225*, configure for a class B network

Tip – If all available DHCP addresses are allocated, it is possible for a Sun Ray DTU to request an address yet not find one available, perhaps because another unit has been allocated IP addresses by multiple servers. To prevent this condition, give each DHCP server enough addresses to serve the all the DTUs in a failover group.

Server Addresses

Server IP addresses assigned for the Sun Ray interconnect should all be unique. Use the `utadm` tool to assign them.

When the Sun Ray DTU boots, it sends a DHCP broadcast request to all possible servers on the network interface. One (or more) server responds with an IP address allocated from its range of addresses. The DTU accepts the first IP address that it receives and configures itself to send and receive at that address.

The accepted DHCP response also contains information about the IP address and port numbers of the Authentication Managers on the server that sent the response.

The DTU then attempts to establish a TCP connection to an Authentication Manager on that server. If it is unable to connect, it uses a protocol similar to DHCP in which it uses a broadcast message to ask the Authentication Managers to identify themselves. The DTU then attempts to connect to the Authentication Managers that responded in the order in which the responses were received.

Note – For the broadcast feature enabled, the broadcast address (255.255.255.255) must be the last one in the list. Any addresses after the broadcast address are ignored. If the local server is not in the list, Sun Ray DTUs cannot attempt to contact it.

Once a TCP connection to an Authentication Manager has been established, the DTU presents its token. The token is either a pseudo-token representing the individual DTU (its unique Ethernet address) or a smart card. The Session Manager then starts an X window/X server session and binds the token to that session.

The Authentication Manager then sends a query to all of the other Authentication Managers on the same subnet and asks for information about existing sessions for the token. The other Authentication Managers respond, indicating whether there is a session for the token and the last time the token was connected to the session.

The requesting Authentication Manager selects the server with the latest connection time and redirects the DTU to that server. If no session is found for the token, the requesting Authentication Manager selects the server with the lightest load and redirects the token to that server. A new session is created for the token.

The Authentication Manager enables both implicit (smart card) and explicit switching. For explicit switching, see “Group Manager” on page 186.

Configuring DHCP

In a large IP network, a DHCP server distributes the IP addresses and other configuration information for interfaces on that network.

Coexistence of the Sun Ray Server With Other DHCP Servers

The Sun Ray interconnect is not intended to be shared with any other network traffic.

The Sun Ray DHCP server can coexist with DHCP servers on other subnets, provided you isolate the Sun Ray DHCP server from other DHCP traffic. Verify that all routers on the network are configured not to relay DHCP requests. This is the default behavior for most routers.

Caution – If the IP addresses and DHCP configuration data are not set up correctly when the interfaces are configured, the failover feature cannot work properly. In particular, configuring the Sun Ray server’s interconnect IP address as a duplicate of any other server’s interconnect IP address may cause the Sun Ray Authentication Manager to throw “Out of Memory” errors.

Administering Other Clients

The Sun Ray interconnect is intended to be private. No devices other than switches and Sun Ray DTUs should reside on the interconnect. If the Sun Ray server has multiple interfaces (one of which is the Sun Ray interconnect), the Sun Ray DHCP server should be able to manage both the Sun Ray interconnect and the other interfaces without cross-interference.

▼ To Set Up IP Addressing on Multiple Servers Each With One Sun Ray Interface

1. Log in to the Sun Ray server as superuser and, open a shell window. Type:

```
# /opt/SUNWut/sbin/utadm -a <interface_name>
```

where *<interface_name>* is the name of the Sun Ray network interface to be configured; for example, *hme[0-9]*, *qfe[0-9]*, or *ge[0-9]*. You must be logged on as superuser to run this command. The *utadm* script configures the interface (for example, *hme1*) at the subnet (in this example, 128).

The script displays default values, such as the following:

```
Selected values for interface "hme1"
  host address:      192.168.128.1
  net mask:         255.255.255.0
  net address:      192.168.128.0
  host name:        serverB-hme1
  net name:         SunRay-hme1
  first unit address: 192.168.128.16
  last unit address: 192.168.128.240
  firmware server:  192.168.128.1
  router:           192.168.128.1
  alternate servers:
```

The default values are the same for each server in a failover group. Certain values must be changed to be unique to each server.

2. When you are asked to accept the default values, type *n*:

```
Accept as is? ([Y]/N): n
```

3. Change the second server's IP address to a unique value, in this case 192.168.128.2:

```
new host address: [192.168.128.1] 192.168.128.2
```

4. Accept the default values for netmask, host name, and net name:

```
new netmask: [255.255.255.0]  
new host name: [serverB-hme1]
```

5. Change the DTU address ranges for the interconnect to unique values. For example:

```
Do you want to offer IP addresses for this interface? [Y/N]:  
new first Sun Ray address: [192.168.128.16] 192.168.128.50  
number of Sun Ray addresses to allocate: [205] 34
```

6. Accept the default firmware server and router values:

```
new firmware server: [192.168.128.2]  
new router: [192.168.128.2]
```

The utadm script asks if you want to specify an alternate server list:

```
Specify alternate server list? (Y/[N]): n
```

These servers are specified by a file containing a space-delimited list of server IP addresses or by manually entering the server IP addresses.

Note – Under most conditions, an alternate server list is not required.

The newly selected values for interface hme1 are displayed:

```
Selected values for interface "hme1"
  host address:      192.168.128.2
  net mask:         255.255.255.0
  net address:      192.168.128.0
  host name:        serverB-hme1
  net name:         SunRay-hme1
  first unit address: 192.168.128.50
  last unit address: 192.168.128.83
  firmware server:  192.168.128.2
  router:           192.168.128.2
  alternate servers:
```

7. If these are correct, accept the new values:

```
Accept as is? ([Y]/N): y
```

8. Stop and restart the server and power cycle the DTUs to download the firmware.

TABLE 11-2 lists the options available for the utadm command. For additional information, see the utadm man page.

TABLE 11-2 Available Options

Option	Definition
-c	Create a framework for the Sun Ray interconnect.
-r	Remove all Sun Ray interconnects.
-A <subnetwork>	Configure the subnetwork specified as a Sun Ray sub-network. This option only configures the DHCP service to allocate IP address and/or to provide Sun Ray parameters to Sun ray clients. It also will automatically turn on support for LAN connections from a shared subnetwork.
-a <interface_name>	Add <interface_name> as Sun Ray interconnect.
-D <subnetwork>	Delete the subnetwork specified form the list of configured Sun Ray subnetworks.
-d <interface_name>	Delete <interface_name> as Sun Ray interconnect.
-l	Print the current configuration for all the Sun Ray subnetworks, including remote subnetworks.
-p	Print the current configuration.

TABLE 11-2 Available Options (Continued)

Option	Definition
-f	Take a server offline
-n	Bring a server online
-x	Print the current configuration in a machine-readable format

Group Manager

Every server has a group manager module that monitors availability and facilitates redirection. It is coupled with the Authentication Manager.

In setting policies, the Authentication Manager uses the selected authentication modules and decides what tokens are valid and which users have access.

Warning – The same policy must exist on every server in the failover group or undesirable results might occur.

Each Group Manager creates maps of the failover group topology by exchanging `keepalive` messages among themselves. These `keepalive` messages are sent to a well-known UDP port (typically 7009) to all of the configured network interfaces. The `keepalive` message contains enough information for each Sun Ray server to construct a list of servers and the common subnets that each server can access. In addition, the group manager remembers the last time that a `keepalive` message was received from each server on each interface.

The `keepalive` message contains the following information about the server:

- Server's host name
- Server's primary IP address
- Elapsed time since it was booted
- IP information for every interface it can be reach
- Machine information (number and speed of CPUs, configured RAM, and so on)
- Load information (CPU and memory utilization, number of sessions, and so on)

Note – The last two items are used to facilitate load distribution. See “Load Balancing” on page 188.

The information maintained by the Group Manager is used primarily for server selection when a token is presented. The server and subnet information is used to determine the servers to which a given DTU can connect. These servers are queried about sessions belonging to the token. Servers whose last `keepalive` message is older than the timeout are deleted from the list, since either the network connection or the server is probably down.

Redirection

In addition to automatic redirection at authentication, you can use the `utselect` graphical user interface (GUI) or `utswitch` command for manual redirection.

Note – The `utselect` GUI is the preferred method to use for server selection. For more information, see the `utselect` man page.

Group Manager Configuration

The Authentication Manager configuration file, `/etc/opt/SUNWut/auth.props`, contains properties used by the Group Manager at runtime. The properties are:

- `gmport`
- `gmKeepAliveInterval`
- `enableGroupManager`
- `enableLoadBalancing`
- `enableMulticast`
- `multicastTTL`
- `gmSignatureFile`
- `gmDebug`

These properties have default values that are rarely changed. Only very knowledgeable Sun support personnel should direct customers to change these values to help tune or debug their systems. If any properties are changed, they must be changed for all servers in the failover group, since the `auth.props` file must be the same on all servers in a failover group.

▼ To Restart the Authentication Manager

Property changes do not take effect until the Authentication Manager is restarted.

- As superuser, open a shell window and type:

```
# /opt/SUNWut/sbin/utrestart
```

The Authentication Manager is restarted.

Load Balancing

At the time of a server failure, the Group Manager on each remaining server attempts to distribute the failed server's sessions evenly among the remaining servers. The load balancing algorithm takes into account each server's capacity (number and speed of its CPUs) and load so that larger or less heavily loaded servers host more sessions.

When the Group Manager receives a token from a Sun Ray DTU and finds that no server owns an existing session for that token, it redirects the Sun Ray DTU to the server in the group with the lightest load. It is possible that a Sun Ray DTU appears to connect twice; once on the server that answered its DHCP request and a second time on a server that was less loaded than the first.

▼ To Turn Off the Load Balancing Feature

- In the `auth.props` file set:

```
enableLoadBalancing = false
```

Setting Up a Failover Group

A failover group is one in which two or more Sun Ray servers use a common policy and share services. It is composed of a primary server and one or more secondary servers. For such a group, you must configure Sun Ray Data Store to enable replication of the Sun Ray administration data across the group.

The `utconfig` command sets up the internal database for a single system initially, and enables the Sun Ray servers for failover. The `utreplica` command then configures the Sun Ray servers as a failover group.

If the Sun Ray server is currently monitored by Sun Management Center, `utreplica` restarts the agent automatically. Log files for Sun Ray servers contain time-stamped error messages which are difficult to interpret if the time is out of sync. To make troubleshooting easier, all secondary servers should periodically synchronize with their primary server.

Tip – Use `rdate <primary-host>`, preferably with `crontab`, to synchronize secondary servers with their primary server.

Primary Server

Layered administration of the group takes place on the primary server. The `utreplica` command designates a primary server, advises the server of its Administration Primary status, and tells it the host names of all the secondary servers.

Tip – Configure the primary server before you configure the secondary servers.

▼ To Specify a Primary Server

- As a superuser, open a shell window on the primary server and type:

```
# /opt/SUNWut/sbin/utreplica -p secondary-server1 [secondary-server2 ...]
```

where `secondary_server1 [secondary_server2...]` is a space-separated list of unique host names of the secondary servers.

Secondary Server

The secondary servers in the group store a replicated version of the primary server's administration data. Use the `utreplica` command to advise each secondary server of its secondary status and also the host name of the primary server for the group.

▼ To Specify Each Secondary Server

- As superuser, open a shell window on the secondary server and type:

```
# /opt/SUNWut/sbin/utreplica -s primary-server
```

where *primary-server* is the hostname of the primary server.

▼ To Add Additional Secondary Servers

To include an additional secondary server in an already configured failover group:

1. **On the primary server, rerun `utreplica -p -a` with a list of secondary servers.**

```
# /opt/SUNWut/sbin/utreplica -p -a secondary-server1,secondary-server2,...
```

2. **Run `utreplica -s primary-server` on the new secondary server.**

```
# /opt/SUNWut/sbin/utreplica -s primary-server
```

Removing Replication Configuration

▼ To Remove the Replication Configuration

- **As superuser, open a shell window and type:**

```
# /opt/SUNWut/sbin/utreplica -u
```

This removes the replication configuration.

Viewing the Administration Status

▼ To Show Current Administration Configuration

- **As superuser, open a shell window and type:**

```
# /opt/SUNWut/sbin/utreplica -l
```

The result indicates whether the server is standalone, primary (with the secondary host names), or secondary (with the Primary host name).

Viewing Failover Group Status

A failover group is a set of Sun Ray servers all running the same release of Sun Ray Server Software and all having access to all the Sun Ray DTUs on the interconnect.

▼ To View Failover Group Status

1. From the navigation menu in the Admin GUI, select the arrow to the left of Failover Group to expand the menu.
2. Click the Status link.

The Failover Group Status window is displayed.

The Failover Group Status window describes the health and current state of multiple Sun Ray servers within your failover group. This window also describes the health of any Sun Ray servers that have responded to a Sun Ray broadcast.

The Failover Group Status window provides information on group membership and network connectivity. The servers are listed by name in the first column. Failover Group Status only displays public networks and Sun Ray interconnect fabrics.

In FIGURE 11-3 the information provided is from the point of view of the server in the upper left hand of the table. In this example the server is nomad-100.

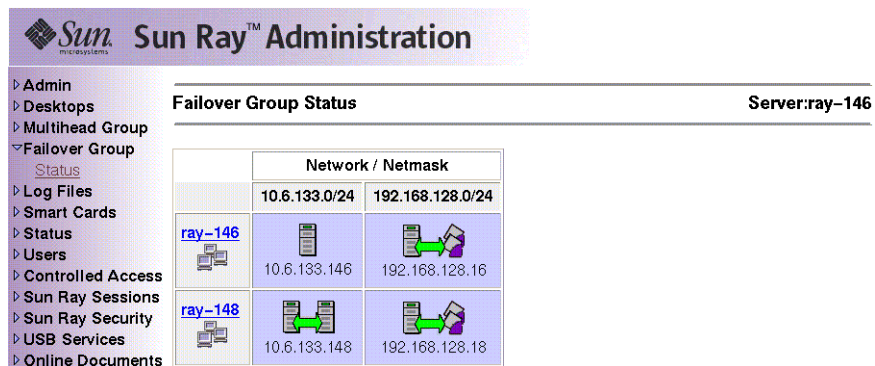

The screenshot shows the Sun Ray Administration interface. On the left is a navigation menu with 'Failover Group' expanded to show a 'Status' link. The main content area is titled 'Failover Group Status' and 'Server:ray-146'. It contains a table with the following data:

	Network / Netmask	
	10.6.133.0/24	192.168.128.0/24
ray-146	10.6.133.146	192.168.128.16
ray-148	10.6.133.148	192.168.128.18







FIGURE 11-3 Failover Group Status Table

Note – Sun Ray server broadcasts do not traverse over routers or servers other than Sun Ray servers.

Sun Ray Failover Group Status Icons

These icons depict current failover group status:

TABLE 11-3 Failover Group Status Icons

Icons	Description
	Information is displayed from the perspective of the system performing the failover status.
	A failover group is established and functioning properly. The trusted hosts are members of this failover group because they share the same group signature.
	A Sun Ray interconnect fabric is established and functioning properly.
	This Sun Ray interconnect fabric is unreachable from the server performing the failover group status. This may indicate a failure in the interconnect fabric between Sun Ray servers if they are supposed to be on the same interconnect. In the past, this host was reachable but is no longer from the point of view of the system performing failover status.
	The servers are unreachable. This network is unreachable from the server performing the Failover Group Status. This could be an alert situation. Over a public network the conditions could be normal, except for the Sun Ray broadcast information, which cannot traverse over routers.
	Servers that appear in the same group use this icon. The signature files, <code>/etc/opt/SUNWut/gmSignature</code> , on those two machines are identical. This icon identifies systems as trusted hosts. Failover occurs for any Sun Ray DTUs connected between these systems. The <code>utgroupsig</code> utility is used to set the <code>gmSignature</code> file.

Recovery Issues and Procedures

If one of the servers of a failover group fails, the remaining group members operate from the administration data that existed prior to the failure.

The recovery procedure depends on the severity of the failure and whether a primary or secondary server has failed.

Note – When the primary server fails, you cannot make administrative changes to the system. For replication to work, all changes must be successful on the primary server.

Primary Server Recovery

There are several strategies for recovering the primary server. The following procedure is performed on the same server which was the primary after making it fully operational.

▼ To Rebuild the Primary Server Administration Data Store

Use this procedure to rebuild the primary server administration data store from a secondary server. This procedure uses the same hostname for the replacement server.

1. **On one of the secondary servers, capture the current data store to a file called `/tmp/store`:**

```
# /opt/SUNWut/srds/lib/utldbmcats \
/var/opt/SUNWut/srds/dbm.ut/id2entry.dbb > /tmp/store
```

This provides an LDIF format file of the current database.

2. **FTP this file to the `/tmp` directory on the primary server.**
3. **Follow the directions in the *Sun Ray Server Software 3 Installation and Configuration Guide* to install Sun Ray Server Software.**
4. **After running `utinstall`, configure the server as a primary server for the group. Make sure that you use the same admin password and group signature.**

```
# utconfig
:
# utreplica -p <secondary-server1> <secondary-server2> ...
```

5. Shut down the Sun Ray services, including the data store:

```
# /etc/init.d/utsvc stop
# /etc/init.d/utds stop
```

6. Restore the data:

```
# /opt/SUNWut/srds/lib/utldif2ldb -c -j 10 -i /tmp/store
```

This populates the primary server and synchronizes its data with the secondary server. The replacement server is now ready for operation as the primary server.

7. Restart Sun Ray services:

```
# utrestart -c
```

8. (Optional) Confirm that the data store is repopulated:

```
# /opt/SUNWut/sbin/utuser -l
```

9. (Optional) Perform any additional configuration procedures.

▼ To Replace the Primary Server with a Secondary Server

Note – This procedure is also known as promoting a secondary server to primary.

1. Choose a server in the existing failover group to be promoted and configure it as the primary server:

```
# utreplica -u
# utreplica -p <secondary-server1> <secondary-server2> ...
```

2. Reconfigure each of the remaining secondary servers in the failover group to use the new primary server.:

```
# utreplica -u
# utreplica -s <new-primary-server>
```

This resynchronizes the secondary server with the new primary server.

Note – This process may take some time to complete, depending on the size of the datastore. Since Sun Ray services will be offline during this procedure, you may want to schedule your secondary servers’ downtime accordingly. Be sure to perform this procedure on each secondary server in the failover group.

Secondary Server Recovery

Where a secondary server has failed, administration of the group can continue. A log of updates is maintained and applied automatically to the secondary server when it has recovered. If the secondary server needs to be reinstalled, repeat the steps described in the *Sun Ray Server Software 3 Installation and Configuration Guide*.

Setting Up a Group Signature

The `utconfig` command asks for a group signature if you chose to configure for failover. The signature, which is stored in the `/etc/opt/SUNWut/gmSignature` file, must be the same on all servers in the group.

The location can be changed in the `gmSignatureFile` property of the `auth.props` file.

To form a fully functional failover group, the signature file must:

- be owned by root with only root permissions
- contain at least eight characters, in which at least two are letters and at least one is not

Tip – For slightly better security, use long passwords.

▼ To Change the Group Manager Signature File

1. As superuser of the Sun Ray server, open a shell window and type:

```
# /opt/SUNWut/sbin/utgroupsig
```

You are prompted for the signature.

2. Enter it twice identically for acceptance.

3. For each Sun Ray server in the group, repeat the steps, starting at step 1.

Note – It is important to use the `utgroupsig` command, rather than any other method, to enter the signature. `utgroupsig` also ensures that internal database replication occurs properly.

Taking Servers Offline

Being able to take servers offline makes maintenance easier. In an offline state, no new sessions are created. However, old sessions continue to exist and can be reactivated unless Sun Ray Server Software is affected.

▼ To Take a Server Offline

- At the command-line interface, type:

```
# /opt/SUNWut/sbin/utadm -f
```

▼ To Bring a Server Online

- At the command-line interface, type:

```
# /opt/SUNWut/sbin/utadm -n
```

User Settings and Concerns

Supported Devices and Libraries

Sun Ray Server Software supports a wide variety of end-user devices, including both mass storage and end-user peripherals that can be connected to a Sun Ray DTU's serial, parallel, or USB ports; however, because of the growing number of USB devices available, it has not been possible to test all of them on Sun Ray DTUs.

Supported Mass Storage Devices

Mass storage support in Sun Ray Server Software 3 is limited to flash disks, memory card readers, Zip drives, and hard drives. SRSS 3 does not support CD, DVD, or floppy drives.

For troubleshooting tips, please see "Troubleshooting USB Mass Storage Devices" on page 218.

Note – Most devices claiming USB 2.0 compliance are backwards compatible and should work with Sun Ray Mass Storage.

Managing Monitor Settings

Sun Ray users can modify their screen resolution settings by invoking `utsettings`. Any resolution selections they make within a session remain effective whenever the session is displayed on that particular DTU. The selection is not lost if the unit goes into power-save mode or is power-cycled.

Settings selected through `utsettings` apply *only* to the DTU where `utsettings` is run; a user moving to another DTU does not bring the new timing along as part of the session. However, the selected timing is retained and used again if a user hot desks back to the original DTU.

If the session is associated with a personal mobile token (a smartcard or an NSCM credential), then `utsettings` offers to make the selected timing permanent. If a user accepts that offer, then the timing is retained and reused on that user's subsequent personal mobile token sessions on the same DTU.

In addition, the administrator may use the `utresadm` command to:

- Arrange for a particular monitor timing to be used whenever a specific token is presented on a specific DTU.
- Arrange for a particular monitor timing to be used on a specific DTU, regardless of the token that is presented at the DTU.
- Arrange for a particular monitor timing to be used on all DTU's regardless of the token that is presented at the DTU.

Any conflict among settings is resolved in favor of the most tightly-specified configuration rule. That is, a configuration record for a specific token at a specific DTU takes precedence over a record for *any token* at that specific DTU, and a configuration record for *any token* at a specific DTU takes precedence over a record for *any token* at *any DTU*.

Configuring Hot Key Preferences

Hot keys can be configured for various Sun Ray utilities. The scope for these hot keys can be:

- System-wide default setting
- User default setting
- System-wide mandatory setting

To support these levels of customization, the utilities look for the properties files in TABLE A-1, in the following order, at startup:

TABLE A-1 Sun Ray Settings Properties Files

File	Defaults	Description
/etc/opt/SUNWut/utslaunch_defaults.properties	System-wide	This file contains helpful default properties. Any properties specified here override any defaults built into the application itself.
\$HOME/.utslaunch.properties	User	This file contains the user's preferred values, which override any application or site-wide defaults.
/etc/opt/SUNWut/utslaunch_mandatory.properties	System-wide mandatory	This file contains site-wide mandatory settings that cannot be overridden by the user. These properties override any application, site-wide, or user defaults.

If your policy is for all DTUs to use a standard hot key, use the system-wide mandatory defaults file to specify this standard key. This prevents users from specifying their own hot key preferences.

The format of the hot key entry in these properties files is:

`<utility_name>.hotkey=value`

where `<utility_name>` is the name of the utility, such as `utsettings` or `utdetach`, and `value` is a valid X keysym name preceded by one or more of the supported modifiers (`Ctrl`, `Shift`, `Alt`, `Meta`) in any order. Values are shown in TABLE A-2.

TABLE A-2 Specific Hot Key Values

Example Value	Notes
Shift+Props	This brings up the Settings GUI.
Ctrl+Alt+Backspace twice	This kills a session.
Ctrl+Alt+Del twice	This kills the process that has taken control of the X server.
Shift+Pause	This detaches a non-smart card mobility session.
Mute+Softer+Louder	This displays the DTU's MAC address.
Ctrl+Power Key	This cycles power.

Users can configure both `Shift+Props` and `Shift+Pause`.

Setting Hot Key Values

▼ To Change the Hot Key for the Settings GUI

If you do not want to use the Sun Props key as your default hot key, use the system-wide defaults file to specify a function key. Users can still specify their preferences in the user defaults file.

Use this procedure to modify the settings GUI for all users on a server.

1. **As superuser, open the `/etc/opt/SUNWut/utslaunch_defaults.properties` file in a text editor.**

Tip – If you want to make the change mandatory, change the value in the `/etc/opt/SUNWut/utslaunch_mandatory.properties` file.

2. **Locate the original hot key entry for the `utdetach` utility and place a # in front of that statement.**

The # comments out the first hot key property.

```
# utdetach.hotkey=Shift Pause
```

3. **Type in the new hot key property after the first statement. For example,**

```
utsettings.hotkey=Shift F8
```

4. **Save the `utslaunch_defaults.properties` file.**

The new hot key takes effect when the next user logs in. The next user to log in uses the new hot key to display the Sun Ray Settings screen. Users who were logged in before you changed the hot key continue to use the old value.

▼ To Change the Hot Key Used to Detach NSCM Sessions

Note – This resembles the procedure for changing the hot key for the settings GUI except for Step 3.

1. As superuser, open the `/etc/opt/SUNWut/utslaunch_defaults.properties` file in a text editor.
2. Locate the original hot key entry for the `utsettings` utility and place a `#` in front of it to comment it out.

```
# utsettings.hotkey=Shift SunProps
```

3. Type in the new hot key property after the first statement. For example,

```
utdetach.hotkey=Alt F9
```

▼ To Change the Hot Key Setting for a Single User

1. In your home directory, create the `.utslaunch.properties` file.
2. Add a line to the `.utslaunch.properties` file with the value for the hot key. For example:

```
utsettings.hotkey=Shift F8
```

3. Save the `.utslaunch.properties` file.
4. Log out and log back in to enable the new hot key.

Note – You can modify other hot keys in a similar fashion.

Power Cycling a Sun Ray DTU

▼ To Power Cycle a Sun Ray DTU

disconnect then reconnect the power cord.

▼ To Perform a Soft Reset

use the key sequence `Ctrl-Power` (the Power key at the right side of the top row of the Sun Type 6 keyboard has crescent moon icon).

▼ To Kill a User's Session

Use the key sequence `Ctrl-Alt-Bksp-Bksp`.

This kills the Xserver process, alerting the current session's parent process to start another session.

Troubleshooting and Tuning Tips

This appendix contains the following sections:

- “Understanding OSD” on page 203
- “Authentication Manager Errors” on page 215
- “Audio” on page 219
- “Troubleshooting USB Mass Storage Devices” on page 218
- “Performance Tuning” on page 221
- “Troubleshooting the Sun Management Center” on page 224

Understanding OSD

Sun Ray Server Software on-screen displays (OSD) to help administrators and others identify problems visually. The most important information about the Sun Ray DTU and its current state is displayed on the screen.

OSD Icon Topography

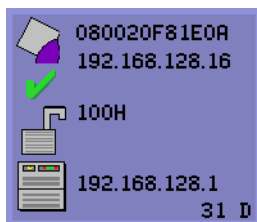

The OSD icons display:

- Ethernet address
- Currently assigned IP address of the DTU
- Link status of the currently connected Sun Ray server
- Authentication Server IP address
- Icon code and DHCP state

To help you locate problems, the OSD icons display a numeric icon code followed by an alphabetic DHCP state code. You can look up the meaning of the numeric OSD message codes in TABLE B-1 and the alphabetic DHCP state codes in TABLE B-2. Encryption and authentication information is also displayed when appropriate.

Note – Sun Ray DTUs can function in a private interconnect or in a simple LAN environment with only an IP address, but additional basic parameters and Sun Ray-specific vendor options are needed for more complex LAN operations, such as when a DTU is located several hops away from the Sun Ray Server’s subnet.

OSD icon messages and codes are summarized in the following tables:

TABLE B-1 Icon Messages

Icon Code	Meaning
1	Sun Ray unit is starting up and is waiting for ethernet link
2	Sun Ray unit is downloading new firmware
3	Sun Ray unit is storing new firmware in its flash memory
4	Either the download or storage of new firmware has failed
5	There is no session to connect with the Sun Ray
6	The server is denying access to the Sun Ray
7	Local pin entry to the smart card has failed
8	In local smartcard pin entry mode
9	There is an over current condition on the USB bus, i.e., the total number of devices draws too much current. Consider using a powered hub.
11	Server is authenticated by the Sun Ray and the graphic/keyboard network connection is encrypted
12	The Sun Ray cannot authenticate the server but the graphic/keyboard network connection is still being encrypted
13	Server authenticated to the Sun Ray; network connection between Sun Ray and server not encrypted
14	Server not authenticated to the Sun Ray; graphic/keyboard network connection is not encrypted
15	The Sun Ray is refusing to talk to the server due to the server’s refusal or inability to authenticate or encrypt the network connection
16	The Sun Ray USB bus is temporarily busy servicing a high-speed device, and the keyboard or mouse may not be responsive to user input.
21	The Sun Ray unit is booting up and is waiting on DHCP IP address and parameter assignment.
22	The Sun Ray unit is booting up and is now waiting for the initial connection to a Sun Ray server.
23	The connection between the Sun Ray and the network is down. Check the network drop cable and (if the network drop cable is okay) the network switch.

TABLE B-1 Icon Messages

Icon Code	Meaning
24	The Sun Ray has disconnected from the previous server.
25	The Sun Ray is being redirected to a new server.
26	The Sun Ray has connected to the server and is waiting for graphics traffic (this is the GNC state).
27	The Sun Ray is broadcasting to locate a Sun Ray server since either it was not provided with Sun Ray specific DHCP parameters or all of the specified servers are not responding. Icon numbers 31 through 34 are the network status display brought up by the user pressing all three audio keys.
31	The network link is up, the server is authenticated, and graphics/keyboard network connections is are encrypted.
32	The network link is up, the server is not authenticated, and graphics/keyboard network connections are encrypted.
33	The network link is up, the server is authenticated and graphics/keyboard are encrypted.
34	The network link is up, the server is not authenticated and graphics/keyboard are not encrypted.
50	The server is refusing to talk to the Sun Ray due to the Sun Ray's refusal or inability to authenticate or encrypt the network connection

TABLE B-2 DHCP State Codes

DCHP State Code	State Meaning
A	DCHP only provided IP address with no additional parameters
B	DCHP provided IP address, subnet mask, and router, but Sun Ray vendor-specific parameters are missing.
C	DHCP provided IP address and Sun Ray vendor-specific parameters, but subnet mask and router are missing.
D	DHCP provided all expected parameters.

TABLE B-3 Power LED

DTU Hardware State	Action to Take
Off	Check to see if the DTU is plugged in. Replace the DTU.
Amber	Hardware fault. Replace the DTU.
Blinking	PROM is corrupted. Check that firmware downloads are properly configured and enabled. Then power cycle the DTU.
Card reader LED remains on even when smart card is removed	Card reader hardware problem. Replace the DTU.

Sun Ray Desktop Unit Startup

The first display a user should see is OSD 1: Waiting for the Interconnect.



Definition: The DTU has passed the power-on self test but has not detected an Ethernet signal yet. This icon is displayed as part of the normal startup phase and is usually displayed for only a few seconds.

▼ Actions to take if this icon stays on for more than 10 seconds:

1. **Check that the Ethernet cable is correctly plugged in to the back of the DTU and the other end is plugged in to the correct hub, switch, or network outlet.**

A link light on the switch or hub indicates that the connection is alive.

2. **If the DTU is connected through a hub or a switch, make sure that the hub or switch is powered on and configured correctly.**

After the Sun Ray desktop unit has verified its network connection, the user should see the DHCP Pending display.



Definition: The DTU has detected the Ethernet carrier but has not yet received its initial parameters or IP address from DHCP. This icon is displayed as part of the normal startup phase and is usually displayed for only a few seconds.

▼ Actions to take if this icon stays on for more than 10 seconds:

1. **Make sure that the DHCP server is configured correctly, is up and running, and has not run out of IP addresses to assign to clients.**
2. **Verify that your DHCP server is configured properly for network parameters.**

At this point, depending on whether you have configured your Sun Ray servers to run on a LAN or a dedicated interconnect, one of the following icons may display:

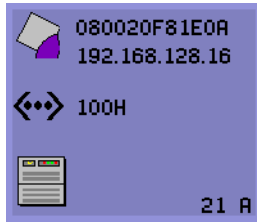

Startup Wait for DHCP Information

After the DHCP server has allocated an IP address, the icon is updated with the unit's IP address; if the response is inadequate, the Sun Ray issues a DHCP `inform` request to attempt to obtain the Sun Ray vendor-specific parameters. The Sun Ray continues all the way through booting with just a DHCP supplied IP address but usually functions better with some additional parameters.

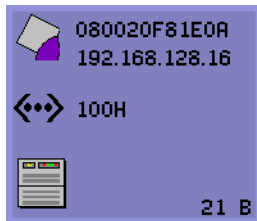

Code 21 A indicates that the DTU got an IP address and is waiting for a DHCP `inform` response to other parameters.

Code 21 B indicates that the DTU got an IP address and IP router and is waiting for Sun Ray vendor-specific options from DHCP `inform`.

Note – If you see a 21 A or 21 B with a DTU IP address in a LAN deployment, the Sun Ray DTU is trying to use DHCP_INFORM to get Sun Ray-specific parameters.

▼ Actions to take:

1. For LAN configurations with other (non-Sun Ray) DHCP services but no `bootp` proxy agent, verify the DHCP server and the Sun Ray vendor tags.
2. For routed configurations, verify that the `bootp` proxy agent is configured correctly in the Sun Ray DTU's subnet and that it points to one of the Sun Ray servers in the failover group.
3. For non-routed private interconnect configurations, the Sun Ray server also performs the functions of a DHCP server. Verify that it is configured properly for DHCP services.

When DHCP has finished, the Sun Ray DTU tries to connect to a Sun Ray server and the authentication manager that is running on that server.

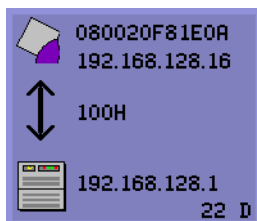

Waiting to Connect to Authentication Manager

Definition: The DTU has received its initial parameters from DHCP but has not yet connected to the Sun Ray Authentication Manager. This icon is displayed as part of the normal startup phase and is usually displayed for only a few seconds.

▼ Actions to take if the icon displays for more than a few seconds or if the DTU continues to reset after the icon is displayed:

1. Make sure that the Sun Ray services, including the Authentication Manager, are up and running on the Sun Ray server.

In a LAN configuration or other routed environment:

2. Make sure that the authentication manager can be reached from the IP address assigned to the DTU.
3. Verify that the routing information the DTU receives is correct.
4. Run `utquery` for the DTU's IP address.

The `utquery` command displays the parameters a Sun Ray DTU has received. If `utquery` fails to display an `AuthSrvr` parameter, the DHCP server for Sun Ray parameters may not be reachable or may not be configured properly. Confirm that the `DHCPServer` and `INFORMServer` values are appropriate. If not, look at your `bootp` relay configurations and DHCP server configurations for network and Sun Ray parameters. For details of these parameters, see the `utquery` man page.

Note – To Restart DHCP on a Solaris server, type the following as superuser:

```
# /etc/init.d/dhcp stop
# /etc/init.d/dhcp start
```

▼ To Identify a Hung Session

- As superuser, type:

```
# /opt/SUNWut/sbin/utdesktop -l -w
```

▼ To Kill a Hung Session

- As superuser, type:

```
# /opt/SUNWut/sbin/utsession -k -t token
```

Firmware Download

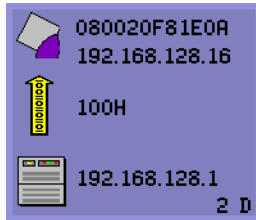

Downloading PROM Software

Definition: The DTU is currently downloading new flash PROM software from the Sun Ray server.

▼ Actions to take:

1. Wait until the download is complete.

Downloading and saving the new PROM software usually takes less than a minute. If you interrupt the download, the DTU has to download new PROM software the next time it reboots.

If the firmware download fails, the following syslog message indicates that the barrier level has been set to prevent Sun Ray DTUs with SRSS 3 firmware from automatically downloading an earlier version of the firmware:

```
Firmware upgrade/downgrade not allowed! Barrier is 300 Firmware level is 0
```

2. Check `/var/opt/SUNWut/log/messages` to confirm that your configuration is set up properly.

Note – For LAN configurations, the minimum barrier level is 200.

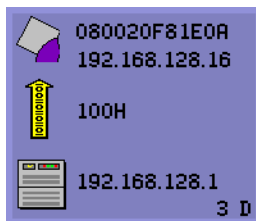

Saving PROM Software

Definition: The DTU has just downloaded new PROM software from the Sun Ray server and is saving it to the DTU's PROM.

▼ Actions to take:

- **Wait until the download is done.**

Downloading and saving the new PROM software usually takes less than a minute. If you interrupt the download, the DTU has to download new PROM software the next time it reboots.



Firmware Download Failed

Definition: The DTU has failed to download new firmware.

▼ Actions to take:

1. **Check the messages file** `/var/opt/SUNWut/log/messages` **to verify the version number.**
2. **Correct, if necessary, with** `utadm -l`.

Bus Busy

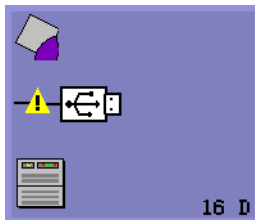

Sun Ray USB Bus Busy

Definition: The Sun Ray USB bus is temporarily busy servicing a high-speed device, and the keyboard or mouse may not be responsive to user input.

This icon typically appears only during an unusually long print job and disappears when the job is done. This is an informational OSD; there is no particular action to take unless it is necessary to kill the print job.

No Ethernet



No Ethernet Connection

Definition: The DTU has an Ethernet address and an IP address but has lost the Ethernet signal. This icon is displayed only after the DTU successfully boots and receives an IP address, but then loses its Ethernet signal.

▼ Actions to take:

1. Check that the Ethernet cable is correctly plugged in to the back of the DTU and the other end is plugged into the correct switch or network outlet.
2. If the DTU is connected through a hub or switch, make sure that the hub or switch is on and configured correctly.

Ethernet Address

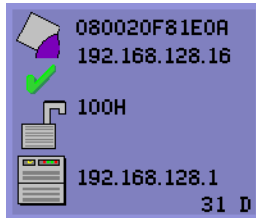

Definition: This OSD, shows the Ethernet address, the currently assigned IP address, the currently connected server, the encryption status, and the DHCP state. To display it, press the three audio volume keys simultaneously.

Tip – To get the same effect on non-Sun keyboard, disconnect and reconnect the Ethernet wire.

Link speed is also indicated (for example, 10F, 10H, 100F, 100H). F stands for full duplex, and H stands for half duplex. 10 stands for 10 Mbps, and 100 for 100 Mbps.

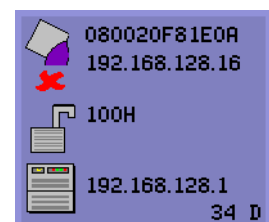
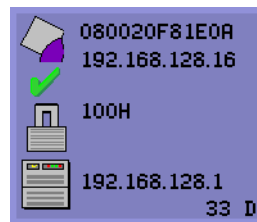
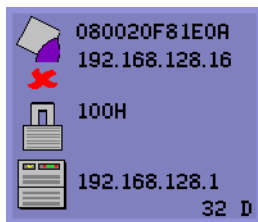

FIGURE B-1 Ethernet Address OSD with Different Encryption and Authentication States

Session Connection Failures

The following icons are displayed when there might be a security breach.



Session Refused

Definition: The client is refusing to connect to a server because it is unable to verify the validity of the Sun Ray server.

This error can occur only if an unknown Sun Ray server intercepts the messages and tries to emulate a valid Sun Ray server. This is a session security breach.

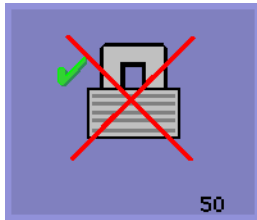

Session Refused

Definition: The server is refusing to grant a session to the client because the client is unable to fulfill the server's security requirements.

▼ Actions to take:

1. Check the client's firmware version.

This error may occur with firmware versions earlier than 2.0 if the server is configured for hard security mode.

2. Upgrade the firmware.

As an alternative, confirm whether your site requires hard security mode. If not, the session can be enabled with soft security mode.

Token Reader Icon



Card Reader Icon

When a site policy disallows pseudo sessions, DTUs configured as token readers display the Card Reader icon instead of the Login Dialog box card.

Card Read Error OSD

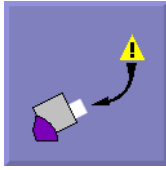

Card Read Error

Definition: The Card Read Error OSD icon appears whenever the firmware is unable to read the card due to one of the following causes:

- The DTU is running old firmware.
- The card contacts are dirty, the contacts on the card reader are dirty, or the card is not properly inserted.
- The card is malfunctioning.
- The card is of a type that the firmware is not configured to read.
- There is an error in the configuration for reading this type of card.

▼ Actions to take:

1. **Upgrade the firmware.**
2. **Replace the card.**

Prompt for Card Insertion OSD



Prompt for Card Insertion

Definition: If the current authentication policy allows access only by card, this OSD icon appears and prompts the user to insert a card.

Access Denied OSD



Access Denied

Definition: The Access Denied OSD icon appears when the current authentication policy denies access to the presented token. Specifically, this icon is displayed if a disabled card has been inserted into an DTU.

The Sun Ray administration model has seven user session types:

- Default—Normal user login
- Register—User self-registration

- Kiosk—Anonymous user operation
- Insert card—User smart card required
- Card error—Unrecognized user smart card type
- No entry—User’s smart card token is blocked
- Session Refused—The server refuses to grant a session to a client that does not meet the server’s security requirements

The first three session types have normal login processes. When there is a problem, the administrator should examine:

- Sun Ray Server configuration files

Caution – Sun Ray Server Software modifies certain system configuration files. In most cases, these changes are identified with SRSS-specific comments. Please do not change these modifications.

- Any locally modified X server startup files
- dtlogin status

Although the last four session types display icons on the Sun Ray DTU, they do not have login processes at all. The icons indicate that the user must take steps before a successful login is possible. If the user immediately removes and reinserts the smart card, the icon disappears, but the Wait for Session OSD remains.

These last four session types and their OSDs should not cause alarm. The user can:

- Insert a recognized smart card in the correct orientation
- Ask the Sun Ray administrator to grant access
- Ask the Sun Ray administrator to download the correct firmware

Wait for Session OSD

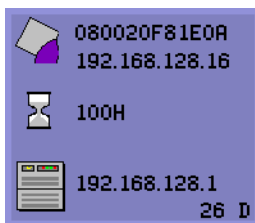

Wait for Session

This OSD represents the transition state for the Sun Ray DTU. If it is displayed for an extended period, there is probably no X Window server running.

Note – The current wait icon is a white “X” cursor. In earlier releases, the wait icon was displayed as a green newt cursor.

Tip – If you suspect that the configuration files have been corrupted, please see “To Determine the Integrity of the Configuration Files” on page 43 in the *Sun Ray Server Software 3 Installation and Configuration Guide*.

Wait Icon Cursor for Default Session Type

This section applies to a normal `dtlogin` session.

The `Xsun` server is indirectly started by the `dtlogin` daemon. In the process of starting the `Xsun` server, the `dtlogin` daemon reads two configuration files:

- `/etc/dt/config/Xservers`
- `/etc/dt/config/Xconfig`

If, after several retries, the `Xsun` process does not start, the `dtlogin` daemon just gives up. The problem can usually be traced back to an older version of the `dtlogin` daemon or the configuration files for the `dtlogin` daemon.

The `dtlogin` daemon has been part of the Solaris operating environment since long before Sun Ray Server Software existed. The Sun Ray administration model uses the `dtlogin` daemon in new ways, and certain bugs in the `dtlogin` daemon have become apparent. Patches to fix these bugs in the `dtlogin` daemon are available.

Patches

For the latest information regarding Sun Ray Server Software patches, check:

<http://www.sun.com/products/sunray/patches.html>

Solaris operating environment patches and other software patches are available at:

<http://access1.sun.com>

Authentication Manager Errors

Authentication Manager errors can be found in the following error logs:

- Installation logs:
 - `/var/adm/log`
 - `/var/opt/SUNWut/log`
- General log files:

- /var/opt/SUNWut/srds/log
- /var/opt/SUNWut/srds/repllog

The general format of the log messages is:

```
timestamp      thread_name      message_class      message
```

For example:

```
May  7 15:01:57 e47c utauthd: [ID 293833 user.info] Worker3
NOTICE: SESSION_OK pseudo.080020f8a5ee
```

Message components are defined as follows:

- **timestamp format:**

year.month.day hours:minutes:seconds

- **thread_name**

There are several different types of threads. The most common thread handles DTU authentication, access control, and session monitoring. These threads are named “worker” plus number. The Worker# thread names are reused when a connection terminates. Other threads are:

- **SessionManager#**—Communicate with `utsessiond` on behalf of a Worker# thread.
- **AdminJobQ**—Used in the implementation to wrap a library that would not otherwise be thread-safe.
- **CallBack#**—Communicate with applications such as `utload`.
- **WatchID**—Used to poll data/terminals from connections
- **Terminator**—Cleans up terminal sessions
- **Group Manager**—Main group manager thread

- **message_class**

Messages with the same thread name are related. The exception occurs when a Worker# thread disconnects a DTU and then purges the connection information from memory. After a Worker# DESTROY message, the next use of that Worker# thread name has no relation to previous uses of the thread name (in other words, the thread names are reused).

- **CLIENT_ERROR**—Indicates unexpected behavior from a DTU. These messages can be generated during normal operation if a DTU is rebooted.
- **CONFIG_ERROR**—Indicates a system configuration error. The Authentication Manager generally exits after one of these errors is detected.
- **NOTICE**—Logs normal events.
- **UNEXPECTED**—Logs events or conditions that were not anticipated for normal operation but are generally not fatal. Some of these errors should be brought to the attention of the Sun Ray product development team.

- **DEBUG**—Only occurs if explicitly enabled. Beneficial to developers. Debug messages can reveal session IDs, which must be kept secret to ensure proper security.

TABLE B-4 Error Message Examples

Error class	Message	Description
CLIENT_ERROR	...Exception ... : cannot send keepAliveInf	Error encountered while attempting to send a keep-alive message to a DTU.
	...keepAlive timeout	A DTU has failed to respond within the allotted time. The session is being disconnected.
	duplicate key:	DTU does not properly implement the authentication protocol.
	invalid key:	DTU does not properly implement the authentication protocol.
CONFIG_ERROR	attempt to instantiate Callback 2nd time.	Program error.
	AuthModule.load	Problem encountered while loading configuration module.
	Cannot find module	Program or installation error.
NOTICE	"discarding response: " + param	No controlling application is present to receive DTU response.
	"NOT_CLAIMED PARAMETERS: " + param	A token was not claimed by any authentication module.
	...authentication module(s) loaded.	Notification that authentication modules have loaded.
	...DISCONNECT ...	Normal notification of disconnection.
UNEXPECTED	"Callback: malformed command"	Bad syntax from a user application such as utload or utidle.
	.../ ... read/0:" + ie	Possible program error.
	.../ ... read/1: ... Exception ...	Error encountered while reading messages from the DTU.
	.../... protocolError: ...	Various protocol violations are reported with this message. This is also a way for utauthd to force the DTU to reset.

Troubleshooting USB Mass Storage Devices

The most common problems encountered with USB mass storage devices on Sun Ray DTUs are described in the following sections.

Device Links Are Not Created

Some mass storage device types are not supported on Sun Ray. Inspect the log file `/var/opt/SUNWut/log/utstoraged.log` for an indication as to why device links were not created.

Device Is Not Automatically Mounted

If the storage medium does not have a Solaris-recognizable filesystem, it will not get automatically mounted. An error message will be logged to:
`/var/opt/SUNWut/log/utmountd.log`

Device Is Not Automatically Unmounted

If the device is unplugged, or if the user's session is disconnected from the DTU, all mount points for that DTU are automatically unmounted unless the user has open references to the mount point. In that case, the mount point becomes stale. A stale mount point persists until the administrator unmounts it manually or until the system is rebooted.

Run the following command to find stale mount points.

```
# /opt/SUNWut/bin/utdiskadm -s
```

Note – Close all references to the mount point or terminate all processes that refer to the mount before running the `umount` command.

Audio

Each time a user logs in to a Sun Ray DTU, a script automatically assigns the `$AUDIODEV` environment variable to that session. One `utaudio(1)` real-time process is assigned to each session. Refer to the `audio(7i)` man page for more information.

Audio Device Emulation

The emulated audio device follows the user session during hot desking. The device name appears in the `$AUDIODEV` environment variable but is transparently interpreted by audio programs for Sun systems. Device nodes are created in the `/tmp/SUNWut/dev/utaudio` directory. The directory tree is completely recreated at boot time.



Caution – Do not remove the `/tmp/SUNWut/dev/utaudio` directory. Deleting this directory prevents existing users with `utaudio` sessions from using their audio pseudo device nodes.

If your application uses `/dev/audio`, the Sun Ray server software reroutes the audio signal appropriately.

Audio Malfunction

If audio features are malfunctioning:

1. To confirm whether audio is working, run the following command on the DTU:

```
% cat /usr/demo/SOUND/sounds/whistle.au >/$AUDIODEV
```

2. Bring up `utsettings`:

```
% utsettings
```

3. Verify that audio output is selected properly, e.g., for headphones or speakers.
4. Check the volume level.
5. Verify that Mute is not selected.

Some applications are hard-coded to use `/dev/audio` for output. Sun Ray System Software provides a redirection library that you can use to correct this behavior.

▼ To Activate the Redirection Library

1. **Set the environment variable `LD_PRELOAD` to `libc_ut.so` in the shell or wrapper from which you started the audio player:**

```
# setenv LD_PRELOAD libc_ut.so
```

2. **Restart the application.**

PDA Synchronization Issues

If your users have problems running PDASync on a Sun Ray, use the following procedure:

3. **Get the latest Java Communications API (javax.comm api version 3 or later) from**
<http://javax.sun.com/products/javacomm/>
4. **Make sure that you are using a supported USB-serial adapter.**
A list of supported USB devices is available at:
http://www.sun.com/io_technologies/sunray/usb/
5. **Click the change Synchronization Settings icon.**
Select the port to which the Palm cradle is connected.
6. **Click OK.**

Tip – If the ports are not shown correctly in the Serial Port drop-down menu, close the application and hot plug the device, then start the application again.

For setup instructions, see “PDA Synchronization” on page 89.

Performance Tuning

Some applications, such as intensive 3-D visual simulations, may run very slowly on Sun Ray. Other applications, such as pseudo-stereo viewers using double-buffering, or high-frequency dynamic color table flips on 8-bit visuals, do not produce the expected visual result.

General Configuration

You can usually improve performance by configuring `/etc/system` shared memory segment parameters. The exact settings depend on application demands and the number of Sun Ray users, but a convenient starting point is:

```
set shmsys:shminfo_shmmax = 0x2000000
set shmsys:shminfo_shmmni = 0x1000
set shmsys:shminfo_shmseg = 0x100
```

Due to the nature of the Xinerama (single virtual X display) mode of multihead, the system shared memory requirements may be even higher. To get reasonable performance, the `shmsys:shminfo_shmmax` parameter must be at least:

```
LARGEST_NUMBER_OF_HEADS * width * height * 4
```

Applications

Placing the user's interactive applications, such as Netscape or StarOffice, or PC interoperability tools, such as Citrix or Tarantella, on the Sun Ray server usually helps performance by reducing network load. The applications benefit from faster transport of commands to the Sun Ray's X server.

Applications that can be configured to use shared memory instead of DGA or OpenGL usually perform better on Sun Ray when they used shared memory.

Sluggish Performance

Sluggish Sun Ray server performance or excessive disk swapping is an indication that the Sun Ray server is under-provisioned. Under these circumstances, there is not enough virtual memory available to start an X Window server instance for a user's session.

The solution in this situation is to add more memory or increase the size of the swap partition. In other situations, network load or packet loss may be too high. In very rare cases, network cables or switch equipment may be defective.

1. **To determine whether there is excessive swapping, use `vmstat 5`.**

```
# vmstat 5
```

If there is excessive swapping, the system may be undersized or overutilized.

2. **Verify that network connections are 100E.**
3. **Use `utcapture` to assess network latency and packet loss.**
As latency and packet loss increase, performance suffers.

Monitor Display Resolution Defaults to 640 x 480

First, eliminate the most obvious possible causes:

- An older monitor
- A bad cable
- Monitor was off when the Sun Ray DTU was started

If the Sun Ray DTU is unable to read DDC data from the monitor, then it defaults to 640 x 480 pixels.

To correct this condition:

1. **Replace the cable**
2. **Restart the Sun Ray DTU after powering the monitor on**
3. **Replace the monitor**
4. **Use the `utresadm` to set persistent display setting to override the default.**

Old Icons (Hourglass with Dashes Underneath) Appear on Display

If the old icons appear on the display, either the DTU's firmware has not been upgraded or it is failing.

1. **Upgrade the firmware from to SRSS 3.**
2. **Follow the procedure to upgrade the firmware. See the *Sun Ray Software 3 Installation and Configuration Guide*.**

You may need to use a dedicated private network.

Port Currently Owned by Another Application

If this message displays, use the following procedure to correct it:

1. **Download the latest Java Communications API (javax.comm API version 2.0.2 and above)**
2. **Make sure that the supported USB-Serial Adapter is used.**
The supported USB devices list is available at
http://www.sun.com/io_technologies/sunray/usb/
3. **Click the Change Synchronization Settings icon and select the appropriate port (to which the Palm cradle should be connected), then click OK.**
4. **If the ports are not correctly shown in the Serial Port drop down menu, close the application and hot plug the device.**
5. **Start the application again.**

Design Tips

- Avoid drawing into off-screen memory and then copying large areas to the screen. This technique produces slow Sun Ray performance.
- `GXcopy` mode is usually the fastest drawing mode.
- To display large images, use shared memory pixmaps, if possible.
- Opaque stipple patterns are faster than transparent stipples.
- Opaque (image) text is faster than other text.

Troubleshooting the Sun Management Center

Usually, if all the software is installed, the agent for Sun Ray monitoring starts automatically.

No Sun Ray Object

If the Sun Ray server has the Sun Management Center agent component installed, but the Detail window shows no Sun Ray object for the Sun Ray server node, load the Sun Ray module:

▼ To Load the Sun Ray Module

- 1. Click the Modules tab.**

Note where the Sun Ray module is listed (if it is not listed, see “No Sun Ray Module” on page 225). For the module to be loaded, it should be listed in Modules with Load Status. In addition, it should be loaded and enabled.

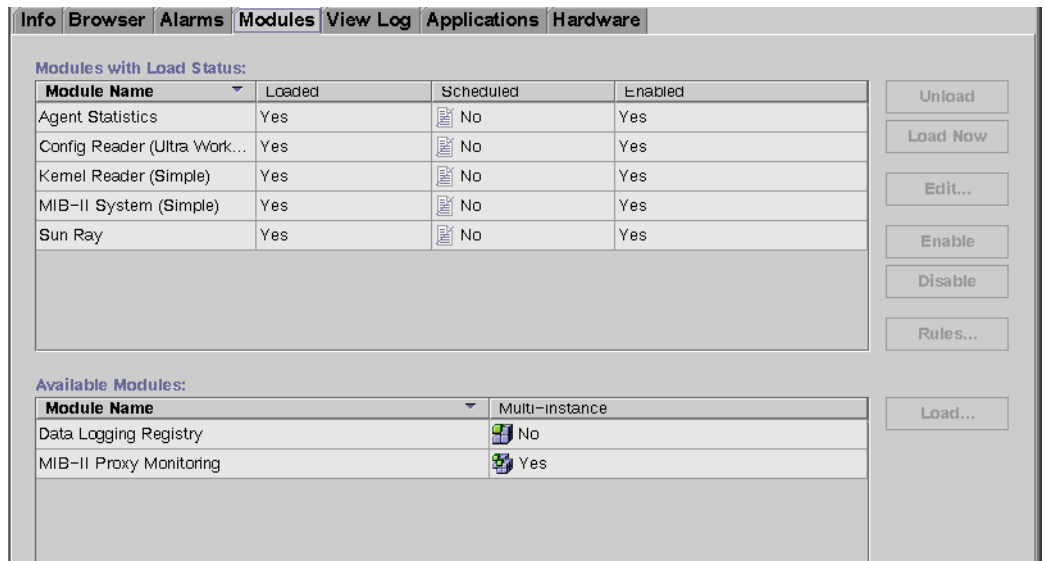

This SunMC panel lists modules by name and indicates whether each is loaded, scheduled, and enabled.

FIGURE B-2 Module Panel

2. **If the Sun Ray module is listed, highlight it and then click the Load button.**
This loads the module and moves it to the Modules with Load Status list.
3. **If the Sun Ray module is disabled, highlight it and then click the Enable button.**
This enables the module.
4. **Return to the Detail window.**
The Detail window shows a Sun Ray object for the Sun Ray server node.

No Sun Ray Module

If, after clicking the Modules tab on the Details window of the Sun Ray server node, the Sun Ray module is not listed, activate the Sun Ray module:

▼ To Activate the Sun Ray Module

1. Register the module by typing:

```
# /opt/SUNWut/sbin/utsumc
```

This command adds the module to the Sun Management Center and restarts the agent if it is active.

2. If you receive the following message, perform steps 3 and 4.

```
Starting the SunMC agent...  
NOTICE:          SunMC agent failed to start.  
                To start it manually run the command
```

3. Check to see if the agent is running:

```
# ps -ef |grep agent
```

If the Sun Management Center agent is running, wait then check the Detail window.

4. If the agent is not running, type the following to start it:

```
# /opt/SUNWsymon/sbin/es-start -a
```

Sun Ray and Network Parameter Delivery (DHCP)

Sun Ray relies on DHCP to obtain network parameters and Sun Ray parameters. Network parameters include IP address, subnet mask, and router.

Sun Ray parameters enable Sun Ray devices to function normally in a Sun Ray environment. For Sun Ray DTUs to be able to discover the Sun Ray server on the network, they need to have at least the `AuthSrvr` parameter delivered through DHCP.

For a more comprehensive treatment of DHCP, see the *Dynamic Host Configuration Protocol RFC* at <http://www.ietf.org/rfc/rfc2131.txt?number=2131>.

For details on *DHCP Options and BOOTP Vendor Extensions*, see <http://www.ietf.org/rfc/rfc2132.txt?number=2132>

TABLE C-1 lists the Sun Ray parameter symbol values defined in the DHCP table. The remainder of this appendix describes the encapsulated options.

TABLE C-1 Sun Ray Parameter Symbol Values (as defined in the DHCP table)

Parameter Name	Vendor ID	Code	Type	Mandatory/ Optional	Comments	
NewTFlags	Vendor=SUNW.NewT.SUNW,	34,	NUMBER,	4,1	Optional	
Intf	Vendor=SUNW.NewT.SUNW,	33,	ASCII,	1,0	Optional	Interface used for Sun Ray service
NewTDispIndx	Vendor=SUNW.NewT.SUNW,	32,	NUMBER,	4,1	Optional	
FWSrvr	Vendor=SUNW.NewT.SUNW,	31,	IP,	1,1	Optional	Firmware server IP address (needed for firmware upgrade)
LogAppl	Vendor=SUNW.NewT.SUNW,	29,	NUMBER,	1,1	Optional	Log level for application
LogVid	Vendor=SUNW.NewT.SUNW,	28,	NUMBER,	1,1	Optional	Log level for video
LogUSB	Vendor=SUNW.NewT.SUNW,	27,	NUMBER,	1,1	Optional	Log level for USB
LogNet	Vendor=SUNW.NewT.SUNW,	26,	NUMBER,	1,1	Optional	Log level for network
LogKern	Vendor=SUNW.NewT.SUNW,	25,	NUMBER,	1,1	Optional	Log level for kernel
LogHost	Vendor=SUNW.NewT.SUNW,	24,	IP,	1,1	Optional	Log level for host
NewTBW	Vendor=SUNW.NewT.SUNW,	30,	NUMBER,	4,1	Optional	Limits bandwidth available for the Sun Ray
NewTVer	Vendor=SUNW.NewT.SUNW,	23,	ASCII,	1,0	Optional	Specifies which firmware version to upgrade to.
AuthPort	Vendor=SUNW.NewT.SUNW,	22,	NUMBER,	2,1	Optional	Sun Ray server port to connect to
AltAuth	Vendor=SUNW.NewT.SUNW,	35,	IP,	1,0	Optional	Alternate set of Sun Ray server IP addresses
AuthSrvr	Vendor=SUNW.NewT.SUNW,	21,	IP,	1,1	Mandatory	Sun Ray server IP address to connect to
BarrierLevel	Vendor=SUNW.NewT.SUNW,	36,	NUMBER,	4,1	Optional	Barrier level for firmware download

Sun Ray parameters are encapsulated vendor-specific options; that is, the value for the standard DHCP vendor-specific information is an encapsulated set of options that only the vendor equipment—the Sun Ray server, in this case—knows how to interpret.

The next byte is 0x1f=31, which represents the FWSrvr parameter, whose function is to indicate the IP address of the firmware TFTP server. The next byte is the length, 4, which is always be true for an IP address. The hexadecimal value is 0x81 0x92 0x3a 0x88, which corresponds to the IP address 129.146.58.136.

Glossary

B

- backplane bandwidth** Sometimes also referred to as switch fabric. A switch's backplane is the pipe through which data flows from an input port to an output port. Backplane bandwidth usually refers to the aggregate bandwidth available amongst all ports within a switch.
- barrier mechanism** To prevent clients from downloading firmware that is older than the firmware they already have, the administrator can set a barrier mechanism. The barrier mechanism symbol `BarrierLevel` is defined by default in the DHCP table of Sun Ray servers running version 2.0 or later of Sun Ray Server Software.
- bpp** Bits per pixel.

C

- CAM** Controlled access mode, also known as *kiosk mode*.
- category 5** The most common type of wiring used in LANs. It is approved for both voice and data (at up to 100Mhz). Also called cat 5.
- client-server** A common way to describe network services and the user processes (programs) of those services.
- cut-through switches** The switch begins forwarding the incoming frame onto the outbound port as soon as it reads the MAC address, while it continues receiving the remainder of the frame.

D

- DHCP** Dynamic Host Configuration Protocol, which is a means of distributing IP addresses and initial parameters to the DTUs.
- domain** A set of one or more system boards that acts as a separate system capable of booting the OS and running independently of any other board.

E

- Ethernet** Physical and link-level communications mechanism defined by the IEEE 802.3 family of standards.
- Ethernet address** The unique hardware address assigned to a computer system or interface board when it is manufactured. See MAC address.
- Ethernet switch** A unit that redirects packets from input ports to output ports. It can be a component of the Sun Ray interconnect fabric.

F

- failover** The process of transferring processes from a failed server to a functional server.
- filling station** When a client's firmware is downgraded to an earlier version because it connects to a server running the earlier version, it needs to be connected to a filling station so that it can download newer firmware. For this purpose, a filling station can be any private network configured for Sun Ray services or any shared network in which the Sun Ray DHCP server is the only DHCP server.
- firmware barrier** See *barrier mechanism*.
- FTP** File Transfer Protocol. The name of the Internet protocol and the program used to transfer files between hosts.

G

GEM Gigabit Ethernet.

H

head Colloquial term for a screen, or display, or monitor, especially in a context where more than one is used in conjunction with the same keyboard and mouse, as in “multihead” feature.

hot desking The ability for a user to remove a smart card, insert it into any other DTU within a server group, and have the user’s session “follow” the user, thus allowing the user to have instantaneous access to the user’s windowing environment and current applications from multiple DTUs.

hot key A pre-defined key that causes something to appear on your screen. A hot key is used to bring up the Settings screen on the Sun Ray DTU.

hot-pluggable A property of a hardware component that can be inserted into or removed from a system that is powered on. USB devices connected to Sun Ray DTUs are hot-pluggable.

I

interconnect fabric All the cabling and switches that connect a Sun Ray server’s network interface cards to the Sun Ray DTUs.

internet A collection of networks interconnected by a set of routers that enable them to function as a single, large virtual network.

Internet The largest internet in the world consisting of large national backbone nets (such as MILNET, NSFNET, and CREN) and a myriad of regional and local campus networks all over the world. It is a global collection of networks connecting a wide range of computers using a common protocol to communicate and share services.

- intranet** Any network that provides similar services within an organization to those provided by the Internet but which is not necessarily connected to the Internet.
- IP address** A unique number that identifies each host or other hardware system on a network. An IP address is composed of four integers separated by periods. Each decimal integer must be in the range 0-255 (for example, 129.144.0.0).
- IP address lease** The assignment of an IP address to a computer system for a specified length of time, rather than permanently. IP address leasing is managed by the Dynamic Host Configuration Protocol (DHCP). Sun Ray DTU IP addresses are leased.

K

- kiosk mode** Same as *CAM*.

L

- LAN** Local area network. A group of computer systems in close proximity that can communicate with one another through some connecting hardware and software.
- layer 2** The data link layer. In the OSI (Open Standards Interconnection) model, there are a total of seven layers. Layer 2 is concerned with procedures and protocols for operating the communication lines between networks as well as clients and servers. Layer 2 also has the ability to detect and correct message errors.
- local host** The CPU or computer on which a software application is running.
- local server** From the client's perspective, the most immediate server in the LAN.
- login** The process of gaining access to a computer system.
- login name** The name by which the computer system knows the user.

M

- MAC address** Media Access Control. A MAC address is a 48-bit number programmed into each local area network interface card (NIC) at the time of manufacture. LAN packets contain destination and source MAC names and can be used by bridges to filter, process, and forward packets. `8:0:20:9e:51:cf` is an example of a MAC address. See also Ethernet address.
- managed object** An object monitored by the Sun Management Center software.
- mobility** For the purposes of the Sun Ray Server Software, the property of a session that allows it to follow a user from one DTU to another within a server group. On the Sun Ray system, mobility requires the use of a smart card or other identifying mechanism.
- modules** Authentication modules are used to implement various site-selectable authentication policies.
- multicasting** The process of enabling communication between Sun Ray servers over their Sun Ray network interfaces in a failover environment.
- multihead** See *head*.
- multiplexing** The process of transmitting multiple channels across one communications circuit.

N

- namespace** A set of names in which a specified ID must be unique.
- network** Technically, the hardware connecting various computer systems enabling them to communicate. Informally, the systems so connected.
- network address** The IP address used to specify a network.
- network interface** An access point to a computer system on a network. Each interface is associated with a physical device. However, a physical device can have multiple network interfaces.
- network interface card** NIC. The hardware that links a workstation or server to a network device.

- network latency** The time delay associated with moving information through a network. Interactive applications such as voice, video displays and multimedia applications are sensitive to these delays.
- network mask** A number used by software to separate the local subnet address from the rest of a given Internet protocol address. An example of a network mask for a class C network is 255.255.255.0.
- network protocol stack** A network suite of protocols, organized in a hierarchy of layers called a stack. TCP/IP is an example of a Sun Ray protocol stack.
- NIC** Network interface card.
- non-smart card mobility** A mobile session on a Sun Ray DTU that does not rely on a smart card.

O

- OSD** On-screen display. The Sun Ray DTU uses small OSD icons to alert the user of potential start-up problems.

P

- patch** A collection of files and directories that replace or update existing files and directories that prevent proper execution of the software on a computer system. The patch software is derived from a specified package format and can only be installed if the package it fixes is already present.
- policies** Authentication Manager, using the selected authentication modules, decides what tokens are valid and which users have access.
- port** (1) A location for passing data in and out of a computer system. (2) The abstraction used by Internet transport protocols to distinguish among multiple simultaneous connections to a single destination host.
- power cycling** Using the power cord to restart a DTU.

S

- screen flipping** The ability to pan to individual screens on a DTU with a single head that were originally created by a multihead group.
- server** A computer system that supplies computing services or resources to one or more clients.
- service** For the purposes of the Sun Ray Server Software, any application that can directly connect to the Sun Ray DTU. It can include audio, video, X servers, access to other machines, and device control of the DTU.
- session** A group of services associated with a single user.
- session mobility** The ability for a session to “follow” a user’s login ID or a token embedded on a smart card.
- smart card** A plastic card containing a microprocessor capable of making calculations.
- spanning tree** The spanning tree protocol is an intelligent algorithm that allows bridges to map a redundant topology and eliminates packet looping in Local Area Networks (LAN).
- store-and-forward switches** The switch reads and stores the entire incoming frame in a buffer, checks it for errors, reads and looks up the MAC addresses, and then forwards the complete good frame out onto the outbound port.
- subnet** A working scheme that divides a single logical network into smaller physical networks to simplify routing.

T

- TCP/IP** Transmission Control Protocol/Internet Protocol (TCP/IP) is a networking protocol that provides communication across interconnected networks, between computers with diverse hardware architectures and operating systems.
- thin client** Thin clients remotely access some resources of a computer server, such as compute power and large memory capacity. The Sun Ray DTUs rely on the server for all computing power and storage.

timeout value The maximum allowed time interval between communications from a DTU to the Authentication Manager.

token In the Sun Ray system, a token must be presented by the user. It is required by the Authentication Manager to consider allowing a user to access the system. It consists of a type and an ID. If the user inserted a smart card, the smart card's type and ID are used as the token. If the user is not using a smart card, the DTU's built-in type (pseudo) and ID (the unit's Ethernet address) are supplied as the token.

U

URL Uniform Resource Locator. A standard for writing a textual reference to an arbitrary piece of data in the World Wide Web (WWW). The syntax of a URL is `protocol://host/localinfo` where `protocol` specifies a protocol to use to fetch the object (like HTTP or FTP), `host` specifies the Internet name of the host on which to find it, and `localinfo` is a string (often a file name) passed to the protocol handler on the remote host.

USB Universal serial bus.

user name The name a computer system uses to identify a particular user. Under UNIX this is a text string of up to eight characters composed of letters (a-z and A-Z), digits (0-9), hyphens (-), and underscores (_) (for example, jpmorgan). The first character must be a letter.

V

virtual frame buffer A region of memory on the Sun Ray server that contains the current state of a user's display.

VLAN Virtual local area network.

W

work group A collection of associated users who exist in near proximity to one another. A set of Sun Ray DTUs that are connected to a Sun Ray server provides computing services to a work group.

X

X server A process which controls a bitmap display device in an X window system. It performs operations on request from client applications.

Index

A

acceptRedirectToken, 96, 98

adapters, 90

Adding

script, 167

Adding applications

calendar, 169

clock, 169

other, 169

admin password, 17, 36

Administration Group

viewing failover group status, 191

Administration Tool, 34, 99

changing the admin password, 36

controlled access mode, 74

adding or editing applications, 76

selecting additional applications, 75

desktops

displaying current properties, 46

editing a single desktop's properties, 49

searching for, 48

viewing, 45

viewing properties of current user, 47

examining log files, 55

finding Sun Ray sessions, 78

locating token readers, 40

log files

viewing messages logs, 56

logging in, 34

managing Sun Ray sessions, 77

smart card

adding, 60

changing the probe order, 59

deleting, 60

viewing or listing configured, 57

viewing the probe order, 59

users

adding a token ID, 70

adding a user with token ID, 68

deleting, 65

deleting a token ID, 71

displaying current properties, 67

editing properties, 70

enabling or disabling a token ID, 71

finding a user, 72

getting a token ID from token reader, 73

viewing by ID, 63

viewing by name, 64

viewing current, 67

viewing all multihead groups, 51

viewing Sun Ray sessions, 80

agent, 136

alarms, 136

Details window, 142

monitoring, 141

setting, 138

Tool Tip window, 143

values, 139

AltAuth, 110, 130, 228

appliance, 30

adding to be monitored, 149

deleting to be excluded, 149

Hot Desking to a multihead group, 160

multihead feature, 153

multihead group, 154

Application

- adding, 167
- ARCFOUR, 103
- attacks
 - man-in-the-middle, 104
- Attribute Editor, 145
- AUDIODEV environment variable, 219
- authentication, 103
 - server, 104
- Authentication Manager, 4, 30, 34, 160, 181, 186
 - configuration file, 187
 - flowchart for primary appliance, 160, 161
 - interacting with Session Manager, 6
 - restarting, 187
- AuthPort, 130, 228
- AuthSrvr, 4, 110, 130, 208, 227, 228
- auto-size feature, 155

B

- bandwidth
 - limited backplane, 10
- barrier
 - firmware, 209
- BarrierLevel, 130, 228
- bidirectional encryption, 104
- BOOTP forwarding, 112
- BYTES SENT, 30

C

- C, 24
- Cabling
 - fiber-optic, 11
- CAM, 166
- CDE toolbar, 154, 159
- central registration, 5
- Cisco IOS Executive, 112
- Cisco IOS-based router, 129
- Citrix, 221
- client
 - authentication, 103
- code
 - DHCP option, 229
- command
 - utadm, 180, 185
 - utcapture
 - data elements, 30

- utconfig, 153, 188, 195
- utmhconfig, 154
- utreplica, 189
- utswitch, 21
- utxconfig, 153
- commands
 - utadm, 23
 - utadm -r, 25
 - utaudio, 219
 - utdetach, 96
 - utfwadm, 26
 - utpolicy, 101, 102
 - utpolicy -i clear, 22
 - utrestart -c, 22
 - utwall, 99, 102
- configuration
 - security, 104, 105
- configuration data
 - DHCP, 23, 99, 179, 182
- console, 136
- controlled access mode
 - adding or editing applications, 76
 - configuring, 74
 - selecting additional applications, 75
- crontab, 189
- cursor
 - green newt, 214
 - X, 214

D

- daemons
 - Sun Ray Service panel, 146
- Data Store, 188
- data store, 8
- DCHP
 - state codes, 205
- dedicated interconnect, 114
- departments, 12
- desktopID, 31
- desktops
 - displaying current properties, 46
 - editing a single desktop's properties, 49
 - searching for, 48
 - viewing, 45
 - viewing properties of current user, 47
- Desktops panel, 148

- device
 - directory, 81
 - links, 83
 - node ownership, 83
 - nodes, 82
 - USB, 82
- DHCP, 180, 207
 - configuring for failover, 182
 - parameters, 227
- DHCP Client Class, 131
- DHCP configuration data, 23, 99, 179, 182
- DHCP option 49, 129
- DHCP options
 - vendor-specific, 130
- DHCP Relay Agent, 112
- DHCP relay agent, 123
- DHCP server, 183
- DHCP servers, 179
- DHCPACK, 229
- DHCPDISCOVER, 111
- DHCPINFORM, 111, 229
- DHCPServer, 208
- dhtadm -R, 24
- directly-connected dedicated interconnect, 117
- directly-connected shared subnet, 114, 119, 120, 122
- display resolution
 - auto-size feature, 155
 - on workgroup monitors, 155
- DSA, 103
- dtlogin, 4, 215
- dtlogin screen, 94
- DTU initialization, 109
- duplicate IP addresses, 23, 99, 179, 182
- Dynamic Host Configuration Protocol (DHCP), 3

E

- e, 179
- each, 179
- encapsulated options, 229
- encryption
 - algorithm, 103
 - bidirectional, 104
 - downstream only, 104
 - upstream only, 104
- environment variables

- LD_PRELOAD, 220
- errors
 - out of memory, 23, 99, 179, 182
- escape tokens, 98
- Ethernet switch, 11

F

- Failover
 - controlled access mode, 174
- failover
 - address allocation formula, 180
 - configuring DHCP, 182
 - group, 135, 177
 - primary server, 189
 - removing replication configuration, 190
 - secondary server, 189
 - Group Manager module, 179
 - principle components needed, 179
 - server IP addresses, 181
 - setting up group, 188
 - taking servers offline, 196
- failover group, 13
 - administration status, 190
 - recovery procedures, 192
 - viewing status, 191
- failover groups, 178
- firmware module, 3
 - PROM version management, 26
- FWSrvr, 130, 131, 228, 230

G

- GDM, 4
- gmSignature, 192, 195
- green newt cursor, 214, 215
- green newt icon, 214
- Group Manager
 - keepalive message, 186
 - load balancing, 2, 188
 - redirection, 19, 187
 - using Authentication Manager properties, 187
- Group manager, 186
- group manager
 - keepalive message, 186
- group manager module, 186
- group signature, 17, 192
 - setting up, 195

GXcopy, 223

H

hacking

- man-in-the-middle attacks, 104

hard security mode, 104

hexadecimal values, 229

Hot Desk, 155

Hot Desking, 83, 93, 219

hot desking, 160

hot key, 198

- changing setting, 201

- changing setting site-wide, 200

- detaching a mobile session, 96

- entry, 199

- values, 199

hotkey key combination, 97

I

icon messages

- OSD, 204

IEEE802.MACID directory, 81

ifname, 117

INFORMServer, 208

Interconnect, 11

interconnect, 11, 183

- boost power of, 11

- dedicated, 114

- implementing a Sun Ray, 10

interconnect fabric, 9

- adding an interface, 24

- deleting an interface, 24

- departments, 12

- failover group, 13

- managing, 23

- printing configuration, 25

- removing an interface, 26

interconnect IP address, 23, 99, 179, 182

Interconnect panel, 147

Internal database, 188

Intf, 130, 228

IOS, 129

IP address

- duplicate, 23, 99, 179, 182

K

keepalive message, 186

key combination, 97

kiosk.conf, 164, 165, 174

kiosk.start, 164

L

LAN, 1

LATENCY, 30

layer 2 switch, 11

LD_PRELOAD environment variable, 220

LDIF, 193

libusb, 90

load balancing, 2, 188

- turning off, 188

log files

- examining, 55

- viewing messages logs, 56

LogAppl, 130, 131, 228

LogHost, 130, 131, 228

login screen, 4

LogKern, 130, 131, 228

LogNet, 130, 131, 228

LogUSB, 130, 131, 228

LogVid, 130, 131, 228

low-bandwidth deployment, 1, 132

M

managed object, 135

- desktops, 148

- Interconnect panel, 147

- monitoring, 144

- Sun Ray system, 144

man-in-the-middle attack, 104

mass storage, 197

message_class, 216

modules, 4

- Registered, 5

- StartSession, 5

monitoring programs

- CA Unicenter, 150

- HP OpenView VPO, 150

- Tivoli TMS, 150

monitors

- display resolution, 155

- mount point
 - stale, 218
- multihead, 221
 - administration tool, 155
 - creating a new group, 156
 - group, 154, 161
 - Hot Desking to an appliance, 160
 - screen display, 154, 155
 - auto-size feature, 155
 - turning on policy from command line, 156
 - turning on policy with administration tool, 156
- multihead feature, 153
- multihead groups
 - viewing all, 51

N

- Netscape, 221
- network
 - adding an interface, 24
 - deleting an interface, 24
 - removing an interface, 26
- NewTBW, 130, 228
- NewTDispIndx, 130, 228
- NewTFlags, 130, 228
- NewTVer, 130, 131, 228
- non-secure session, 104
- NSC mobile session, 93, 102
- NSC mobile session login, 94
- NSCM session, 94
 - enabling from Administration Tool, 99
 - enabling from command line, 101
 - logging in to, 95

O

- OpenGL, 221
- option code, 229
- options
 - encapsulated, 229
 - vendor-specific, 228
- OSD
 - icon messages, 204
 - understanding, 203
- out of memory error, 23, 99, 179, 182

P

- packet loss

- utcapture, 30
- packets, 133
 - out-of-order, 133
- panel
 - Desktops, 148
 - Interconnect, 147
 - Sun Ray System, 145
- panning, 155
- parallel peripherals, 81
- PDA synchronization, 89
- PDASync, 220
- PERCENT LOSS, 30
- peripherals, 197
 - parallel, 81
 - serial, 81
- persistent settings (monitor), 18
- policies, 4
 - removing old, 22
- POST, 3
- power cycle, 202
- power-on self test (POST)
 - firmware module, 3
- Primary server, 188
- printer
 - printing to attached, 87
- printers
 - non-PostScript, 89
 - setting up, 87
- printing, 84
- PROM, 26
- ps, 7
- pseudo-token, 98

Q

- QuickLogin, 94

R

- rdate, 189
- redirection
 - Group Manager, 19, 187
- redundant failover group, 179
- Registered module, 5
- Relay Agent
 - DHCP, 112
- remote shared subnet, 114

- remote subnet, 123
- Remove replication, 190
- restart, 156

S

- screen flipping, 160
- Secondary server, 188
- secure session, 104
- security
 - configuration, 104, 105
 - interconnect, 103
 - session, 105
- security mode
 - hard, 104
 - soft, 104
- security status, 106
- selectAtLogin, 20
- self-registration, 5, 102
- serial peripherals, 81
- server
 - authentication, 103, 104
- Server addresses, 181
- Server-to-switch bandwidth, 11
- service, 6
- session, 6
 - changes, 7
 - connection failures, 107
 - finding, 78
 - managing, 77
 - secure vs non-secure, 104
 - viewing, 80
- session change, 84
- Session Manager, 2, 6
- settings
 - monitor
 - persistent, 18
- shared memory, 221
- Short Cut, 97
- simple failover group, 178
- Simple Network Management Protocol, 136
- smart card
 - adding, 60
 - changing the probe order, 59
 - deleting, 60
 - viewing or listing configured, 57
 - viewing the probe order, 59
- SNMP, 136
- soft security mode, 104
- spoofing, 104
- SRDS, 8
- StarOffice, 221
- StartSession module, 5
- state codes
 - DHCP, 205
- status
 - security, 106
- storage
 - devices
 - supported, 197
 - USB
 - mass, 197
- subnet
 - directly-connected
 - shared, 119, 120, 122
 - remote
 - deployment on, 123
- Sun Directory Services (SunDS) daemon, 27
- Sun Management Center (Sun MC), 135
- Sun MC
 - additional modules, 137
 - components, 136
 - creating an object, 138
 - notifying when parameter reached, 136
 - setting up monitoring environment, 137
- Sun Ray
 - Data Store, 188
- Sun Ray administration data, 34
 - changing, 36
- Sun Ray administration database
 - users
 - adding a token ID, 70
 - adding a user with token ID, 68
 - deleting, 65
 - deleting a token ID, 71
 - displaying current properties, 67
 - editing properties, 70
 - enabling or disabling a token ID, 71
 - finding, 72
 - getting a token ID from a token reader, 73
 - viewing by ID, 63
 - viewing by name, 64
 - viewing current, 67

- Sun Ray appliance, 1, 2, 30
 - finding sessions, 78
 - firmware module, 3
 - managing sessions, 77
 - multihead feature, 153
 - multihead group, 154
 - shield users, 11
 - starting a print queue, 87
 - viewing sessions, 80
- Sun Ray daemons, 146
- Sun Ray DTU
 - updating and upgrading, 26
- Sun Ray interconnect, 183
 - server IP addresses, 181
- Sun Ray module
 - activating for troubleshooting, 226
 - loading, 224
 - troubleshooting, 224
- Sun Ray node
 - creating, 135
- Sun Ray server, 1, 30
 - device directory, 81
 - monitoring with CA Unicenter, 150
 - monitoring with HP OpenView VPO, 150
 - monitoring with Tivoli TMS, 150
 - network interfaces, 12
 - software, 4
 - software daemons, 136
 - viewing all multihead groups, 51
- Sun Ray services, 135
- Sun Ray Services panel
 - daemons, 146
- Sun Ray Settings
 - changing, 50
- Sun Ray system, 135
 - computing model, 1
 - monitoring feature, 136
- Sun Ray System panel
 - displaying, 144
 - refreshing, 145
 - setting alarms, 145
- SunMC, 135
 - Health Monitor module, 137
 - Process Monitoring, 137
- SUNW.NewT.SUNW, 130, 131
- SUNWlibusb, 90
- SUNWlibusb, 90
- SUNWsynom, 137
- SUNWutesa package
 - removing, 152
- Switch
 - high-capacity, 11
 - low-capacity, 11
- switch
 - basic types of 100 Mbps, 11
 - layer 2, 11
- syslog, 209

T

- Tarantella, 221
- TCP, 181
- TerminalGroup policy, 160
- TERMINALID, 30
- TFTP, 230
- thread_name, 216
- TIMESTAMP, 30
- token reader
 - creating, 40
 - getting a token ID from, 73
 - locating, 40
- TOTAL LOSS, 30
- TOTAL PACKET, 30
- troubleshooting
 - activating the Sun Ray module, 226
 - loading the Sun Ray module, 224

U

- ulimit, 166
- Uplink ports, 11
- USB Device Access, 23
- USB device access, 54
- USB devices
 - to manage, 54
- utaction, 16
- utadm, 16, 24
- utadm -A, 122
- utadm command, 23, 180
 - available options, 185
- utadm -L, 123
- utadm -r command, 25
- utaudio command, 219
- utauthd, 217

- utcapture, 16, 133
- utcapture command
 - data elements, 30
- utcard, 16, 28
- utconfig, 16
- utconfig command, 153, 188, 195
- utcrypto, 16, 104
- utdesktop, 16
- utdetach, 16, 199
- utdetach command, 96
- utdiskadm, 16
- utdsd daemon, 27
- utdssync, 16
- uteject, 16
- utfwadm, 16
- utfwadm command, 26
- utfwsync, 17
- utglpolicy, 21
- utgroupsig, 17, 195, 196
- utgstatus, 17
- utidle, 217
- utinstall, 17
- utkiosk, 17
- utload, 217
- utmhadm, 17, 153
- utmhconfig, 17, 153
- utmhconfig command, 154
- utmhscreen, 17
- utmout, 17
- utpolicy, 17, 21, 166
- utpolicy command, 101, 102
- utpolicy -i clear command, 22
- utpreserve, 17
- utpw, 17
- utquery, 17, 133, 208
- utrcmd, 17
- utreader, 17, 21
- utreplica, 18, 189
- utreplica command, 189
- utresadm, 18, 198
- utresdef, 18
- utrestart, 18, 21, 23, 156
- utrestart -c, 22

- utselect, 18, 19, 84, 187
- utsession, 18
- utsessiond, 7, 216
- utset, 18
- utsettings, 18, 198, 199, 201
- utslaunch.properties files, 97
- utsunmc, 18, 152
- utsunmcinstall, 18, 152
- utsvc, 18
- utswitch, 18, 19, 84
- utswitch command, 21
- utumount, 18
- utusbadm, 23
- utuser, 18
- utwall, 18
- utwall command, 99, 102
- utxconfig, 18, 155
- utxconfig command, 153

V

- vendor-specific DHCP options, 130
- vendor-specific options, 131, 228
- virtual frame buffer, 3
- VLAN, 12
 - implementing a Sun Ray interconnect, 10
 - multiple configuration, 10

W

- WAN, 1, 132

X

- X cursor, 214
- X Window Display Manager, 129
- Xconfig, 215
- XINERAMA, 154, 159
- Xinerama, 221
- Xservers, 215
- Xsun, 215