

Sun™ StorEdge™ A3500 Hardware Configuration Guide



THE NETWORK IS THE COMPUTER™

Sun Microsystems, Inc.
901 San Antonio Road
Palo Alto, CA 94303-4900 USA
650 960-1300 Fax 650 969-9131

Part No. 805-4981-11
September 1998, Revision A

Send comments about this document to: docfeedback@sun.com

Copyright 1998 Sun Microsystems, Inc., 901 San Antonio Road • Palo Alto, CA 94303 USA. All rights reserved.
Portions copyright 1997 Symbios Logic, Inc. All rights reserved.

This product or document is protected by copyright and distributed under licenses restricting its use, copying, distribution, and decompilation. No part of this product or document may be reproduced in any form by any means without prior written authorization of Sun and its licensors, if any. Third-party software, including font technology, is copyrighted and licensed from Sun suppliers.

Parts of the product may be derived from Berkeley BSD systems, licensed from the University of California. UNIX is a registered trademark in the U.S. and other countries, exclusively licensed through X/Open Company, Ltd.

Sun, Sun Microsystems, the Sun logo, AnswerBook, StorEdge, and Solaris are trademarks, registered trademarks, or service marks of Sun Microsystems, Inc. in the U.S. and other countries. All SPARC trademarks are used under license and are trademarks or registered trademarks of SPARC International, Inc. in the U.S. and other countries. Products bearing SPARC trademarks are based upon an architecture developed by Sun Microsystems, Inc.

The OPEN LOOK and Sun™ Graphical User Interface was developed by Sun Microsystems, Inc. for its users and licensees. Sun acknowledges the pioneering efforts of Xerox in researching and developing the concept of visual or graphical user interfaces for the computer industry. Sun holds a non-exclusive license from Xerox to the Xerox Graphical User Interface, which license also covers Sun's licensees who implement OPEN LOOK GUIs and otherwise comply with Sun's written license agreements.

RESTRICTED RIGHTS: Use, duplication, or disclosure by the U.S. Government is subject to restrictions of FAR 52.227-14(g)(2)(6/87) and FAR 52.227-19(6/87), or DFAR 252.227-7015(b)(6/95) and DFAR 227.7202-3(a).

DOCUMENTATION IS PROVIDED "AS IS" AND ALL EXPRESS OR IMPLIED CONDITIONS, REPRESENTATIONS AND WARRANTIES, INCLUDING ANY IMPLIED WARRANTY OF MERCHANTABILITY, FITNESS FOR A PARTICULAR PURPOSE OR NON-INFRINGEMENT, ARE DISCLAIMED, EXCEPT TO THE EXTENT THAT SUCH DISCLAIMERS ARE HELD TO BE LEGALLY INVALID.

Copyright 1998 Sun Microsystems, Inc., 901 San Antonio Road • Palo Alto, CA 94303 Etats-Unis. Tous droits réservés.
Des portions de ce produit sont protégées par un copyright (1997) de Symbios Logic, Inc. Tous droits réservés.

Ce produit ou document est protégé par un copyright et distribué avec des licences qui en restreignent l'utilisation, la copie, la distribution, et la décompilation. Aucune partie de ce produit ou document ne peut être reproduite sous aucune forme, par quelque moyen que ce soit, sans l'autorisation préalable et écrite de Sun et de ses bailleurs de licence, s'il y en a. Le logiciel détenu par des tiers, et qui comprend la technologie relative aux polices de caractères, est protégé par un copyright et licencié par des fournisseurs de Sun.

Des parties de ce produit pourront être dérivées des systèmes Berkeley BSD licenciés par l'Université de Californie. UNIX est une marque déposée aux Etats-Unis et dans d'autres pays et licenciée exclusivement par X/Open Company, Ltd.

Sun, Sun Microsystems, le logo Sun, AnswerBook, StorEdge, et Solaris sont des marques de fabrique ou des marques déposées, ou marques de service, de Sun Microsystems, Inc. aux Etats-Unis et dans d'autres pays. Toutes les marques SPARC sont utilisées sous licence et sont des marques de fabrique ou des marques déposées de SPARC International, Inc. aux Etats-Unis et dans d'autres pays. Les produits portant les marques SPARC sont basés sur une architecture développée par Sun Microsystems, Inc.

L'interface d'utilisation graphique OPEN LOOK et Sun™ a été développée par Sun Microsystems, Inc. pour ses utilisateurs et licenciés. Sun reconnaît les efforts de pionniers de Xerox pour la recherche et le développement du concept des interfaces d'utilisation visuelle ou graphique pour l'industrie de l'informatique. Sun détient une licence non exclusive de Xerox sur l'interface d'utilisation graphique Xerox, cette licence couvrant également les licenciés de Sun qui mettent en place l'interface d'utilisation graphique OPEN LOOK et qui en outre se conforment aux licences écrites de Sun.

CETTE PUBLICATION EST FOURNIE "EN L'ETAT" ET AUCUNE GARANTIE, EXPRESSE OU IMPLICITE, N'EST ACCORDEE, Y COMPRIS DES GARANTIES CONCERNANT LA VALEUR MARCHANDE, L'APTITUDE DE LA PUBLICATION A REPENDRE A UNE UTILISATION PARTICULIERE, OU LE FAIT QU'ELLE NE SOIT PAS CONTREFAISANTE DE PRODUIT DE TIERS. CE DENI DE GARANTIE NE S'APPLIQUERAIT PAS, DANS LA MESURE OU IL SERAIT TENU JURIDIQUEMENT NUL ET NON AVENU.



Contents

Preface v

1. Host Connections 1-1

- 1.1 Configuration Guidelines 1-2
- 1.2 Supported Host Configurations 1-3
 - 1.2.1 Single Host 1-3
 - 1.2.2 Daisy Chain 1-4
 - 1.2.3 Independent Controller 1-5
 - 1.2.4 Multi-Initiator 1-6
- 1.3 Ultra 2 Host System—Power Connection Requirement 1-7

2. StorEdge A3500 Configurations 2-1

- 2.1 StorEdge D1000 Disk Array Settings 2-2
 - 2.1.1 1x2 Configuration 2-3
 - 2.1.2 1x5 Configuration 2-5
 - 2.1.3 2x7 Configuration 2-7
 - 2.1.4 3x15 Configuration 2-9
- 2.2 1x2 Cabling 2-11
 - 2.2.1 SCSI Cabling 2-11
 - 2.2.2 Power Connections 2-13
- 2.3 1x5 Cabling 2-14

- 2.3.1 SCSI Cabling 2-14
- 2.3.2 Power Connections 2-16
- 2.4 2x7 Cabling 2-17
 - 2.4.1 SCSI Cabling 2-17
 - 2.4.2 Power Connections 2-19
- 2.5 3x15 Cabling 2-20
 - 2.5.1 SCSI Cabling 2-21
 - 2.5.2 Power Connections 2-25
 - 2.5.3 Connecting to AC Power Source 2-25
 - 2.5.4 Power Connections 2-26

Preface

Sun StorEdge A3500 Hardware Configuration Guide provides configuration instructions for the Sun™ StorEdge™ A3500 systems. These instructions are designed for an experienced system administrator.

Using UNIX Commands

This document does not contain information on basic UNIX® commands and procedures such as shutting down the system, booting the system, and configuring devices.

See one or more of the following for this information:

- *Solaris 2.x Handbook for SMCC Peripherals*
- AnswerBook™ online documentation for the Solaris™ 2.x software environment
- Other software documentation that you received with your system

Typographic Conventions

TABLE P-1 Typographic Conventions

Typeface or Symbol	Meaning	Examples
AaBbCc123	The names of commands, files, and directories; on-screen computer output.	Edit your <code>.login</code> file. Use <code>ls -a</code> to list all files. % You have mail.
AaBbCc123	What you type, when contrasted with on-screen computer output.	% su Password:
<i>AaBbCc123</i>	Book titles, new words or terms, words to be emphasized. Command-line variable; replace with a real name or value.	Read Chapter 6 in the <i>User's Guide</i> . These are called <i>class</i> options. You <i>must</i> be <i>root</i> to do this. To delete a file, type <code>rm filename</code> .

Shell Prompts

TABLE P-2 Shell Prompts

Shell	Prompt
C shell	<i>machine_name</i> %
C shell superuser	<i>machine_name</i> #
Bourne shell and Korn shell	\$
Bourne shell and Korn shell superuser	#

Related Documentation

TABLE P-3 Related Documentation

Title	Part Number
<i>Sun StorEdge A3000 Controller Module Guide</i>	805-4980-xx
<i>Sun StorEdge A3500 Task Map</i>	805-4982-xx

Sun Documentation on the Web

The `docs.sun.comsm` web site enables you to access Sun technical documentation on the Web. You can browse the `docs.sun.com` archive or search for a specific book title or subject at:

`http://docs.sun.com`

Sun Welcomes Your Comments

We are interested in improving our documentation and welcome your comments and suggestions. You can email your comments to us at:

`docfeedback@sun.com`

Please include the part number of your document in the subject line of your email.

Host Connections

This chapter contains configurations for one or two Sun StorEdge A3000 controller modules connected to one or more hosts. It also contains information about connecting power to an Ultra™ host system.

- Configuration Guidelines—page 1-2
- Supported Host Configurations—page 1-3
 - Single Host—page 1-3
 - Daisy Chain—page 1-4
 - Independent Controller—page 1-5
 - Multi-Initiator—page 1-6
- Ultra 2 Host System—Power Connection Requirement—page 1-7

1.1 Configuration Guidelines

Use the following guidelines for installing and cabling or reconfiguring your system.

- Do not exceed a SCSI bus length of 25 meters.
- Make sure that the last Sun StorEdge A3000 controller module in any daisy chain has a total of two terminators, one in each SCSI OUT port.
- If you are adding a controller module to an already existing configuration, halt all activity on the SCSI bus before removing any SCSI cables.
- Once you finish cabling the devices and powering on, reboot the system by typing `boot -r` at the `ok` prompt before beginning any SCSI bus activity.

Perform a system check to make sure that SCSI connections are secure. Look for fault LEDs on the hardware or error messages in the RAID Manager GUI.

Note – Refer to your server and rack documentation for instructions on grounding the StorEdge A3500 cabinet.

1.2 Supported Host Configurations

The examples that follow show the cable connections for configurations that are supported by Sun Microsystems™.

1.2.1 Single Host

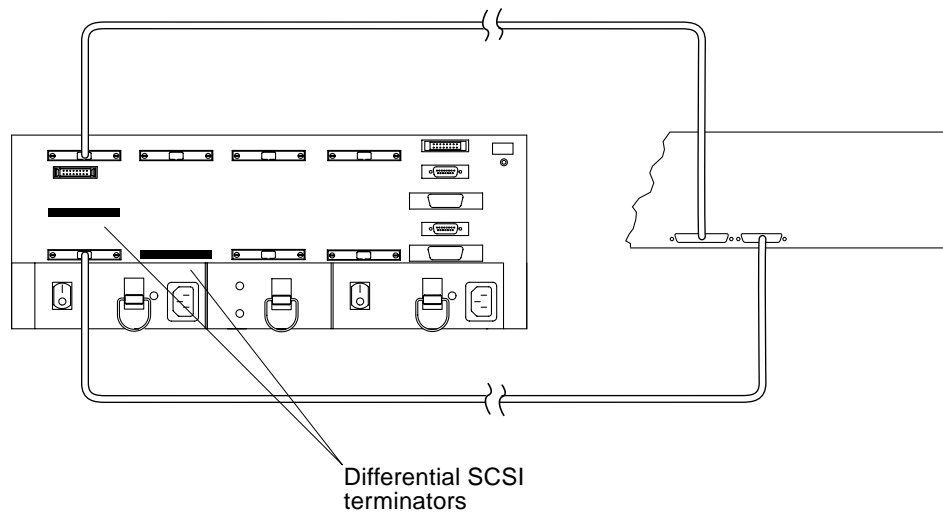

FIGURE 1-1 Single Host Connected to a Sun StorEdge A3000 Controller Module

1.2.2 Daisy Chain

You can daisy chain controller modules in the same or separate cabinets.

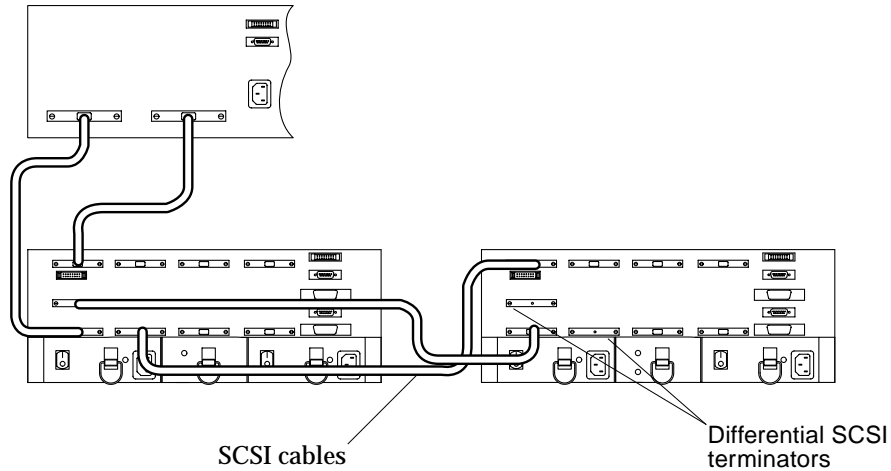

FIGURE 1-2 Two Sun StorEdge A3000 Controller Modules Daisy Chained to One Host

Note – The SCSI cables between the two controller modules are crossed to prevent the SCSI IDs for the controllers from conflicting.

1.2.3 Independent Controller

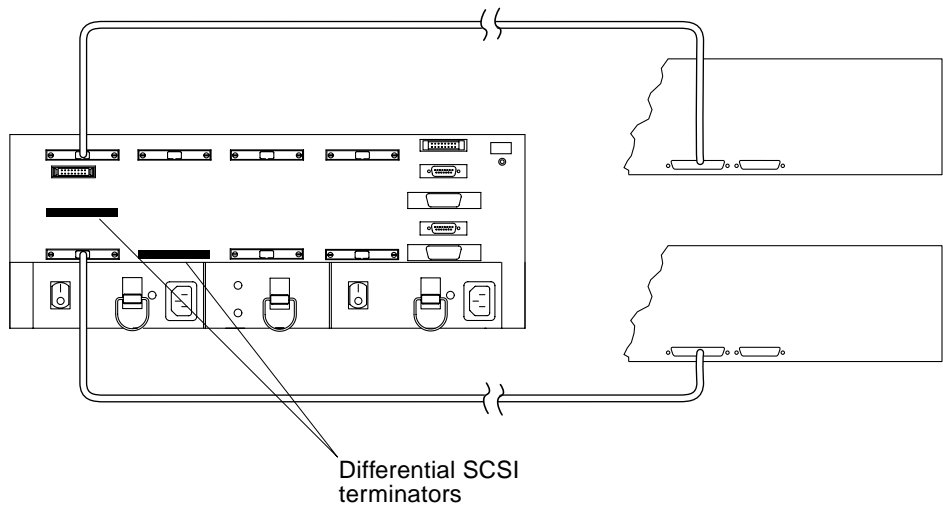

FIGURE 1-3 Independent Controller—One Sun StorEdge A3000 Controller Connected to Two Hosts

1.2.4 Multi-Initiator

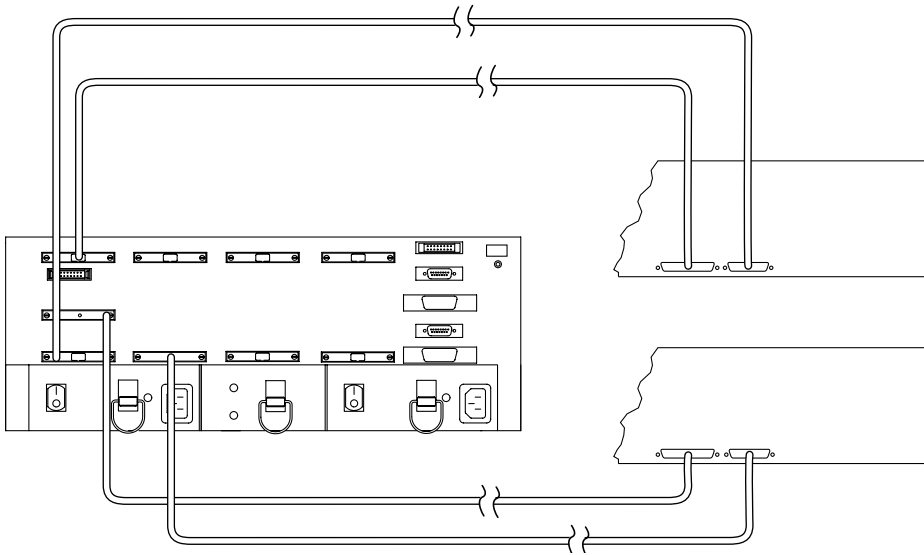

FIGURE 1-4 Two-Node Multi-Initiator Configuration

Note – For more detailed information regarding the two-node multi-initiator configuration, such as setting host SCSI IDs, refer to the SPARCcluster™ PDB™ documentation that is shipped with the host system.

1.3 Ultra 2 Host System—Power Connection Requirement

You can connect a controller module to an Ultra 2 host system; however, you must connect the power cord of the Ultra 2 host to one of the AC power sequencers in the expansion cabinet that contains the controller module.

You need to order one of the following power cords depending on the type of power sequencer in the expansion cabinet (FIGURE 1-5):

- Ultra™ Enterprise™ expansion cabinet and StorEdge expansion cabinet—part number 530-2197-xx
- 56-Inch Data Center expansion cabinet—part number 180-1189-xx (United States) or part number 180-1190-xx NEMA (European)



Caution – Failure to connect the power cord correctly as described here may cause excessive ground current that could damage the system.

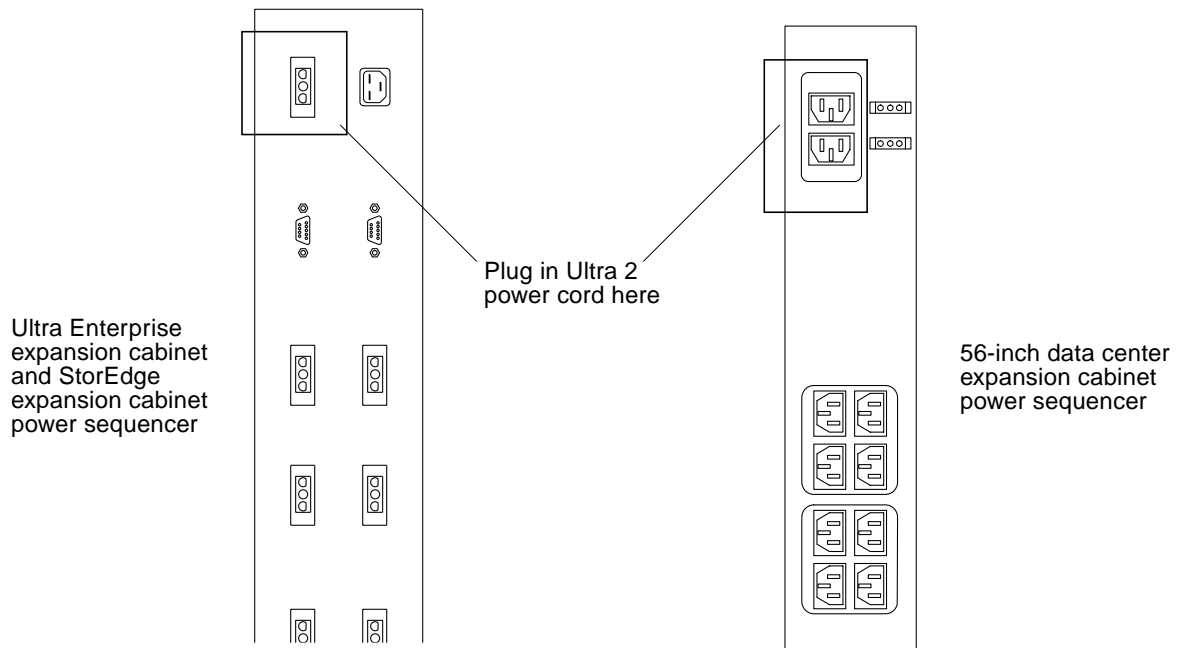

FIGURE 1-5 AC Power Sequencers—Ultra 2 Power Connector

1. Gain access to the AC power sequencers.

See the documentation that came with the expansion cabinet.

2. Route the power cable from the Ultra 2 host under the expansion cabinet frame on the same side as the power sequencer.

3. Plug the power cord from the Ultra 2 host into the top power connector of either power sequencer (FIGURE 1-5).

The power connectors are located on the other side of the power sequencer from the main switch.

4. Reassemble the expansion cabinet.

See the documentation that came with the expansion cabinet.

StorEdge A3500 Configurations

This chapter contains information about setting up the following configurations:

- One controller module with two StorEdge D1000 disk arrays (1x2)
- One controller module with five StorEdge D1000 disk arrays (1x5)
- Two controller modules with seven StorEdge D1000 disk arrays (2x7)
- Three controller modules with fifteen StorEdge D1000 disk arrays (3x15)

The chapter is divided into the following sections:

- StorEdge D1000 Disk Array Settings—page 2-2
 - 1x2 Configuration—page 2-3
 - 1x5 Configuration—page 2-5
 - 2x7 Configuration—page 2-7
 - 3x15 Configuration—page 2-9
- 1x2 Cabling—page 2-11
 - SCSI Cabling—page 2-11
 - Power Connections—page 2-13
- 1x5 Cabling—page 2-14
 - SCSI Cabling—page 2-14
 - Power Connections—page 2-16
- 2x7 Cabling—page 2-17
 - SCSI Cabling—page 2-17
 - Power Connections—page 2-19
- 3x15 Cabling—page 2-20
 - SCSI Cabling—page 2-21
 - Power Connections—page 2-25

2.1 StorEdge D1000 Disk Array Settings

This section describes how to set the following attributes for StorEdge D1000 disk arrays (FIGURE 2-1) in 1x2, 1x5, 2x7, and 3x15 configurations:

- Option switch
- Module ID
- SCSI jumper cables and terminators

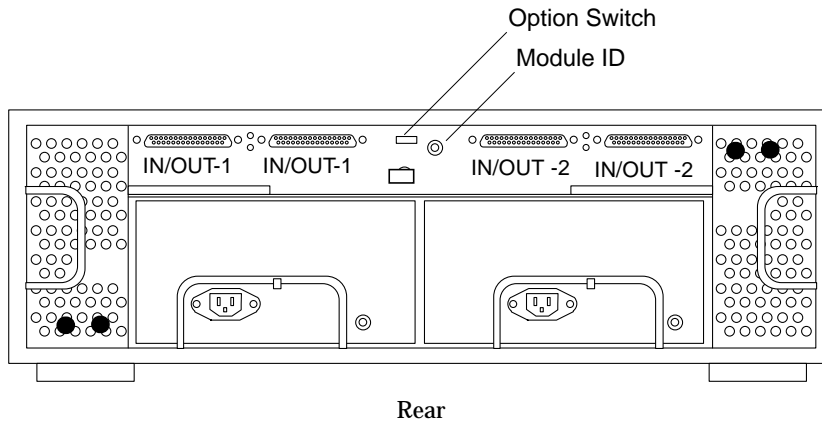

FIGURE 2-1 StorEdge D1000 Disk Array

2.1.1 1x2 Configuration

2.1.1.1 Option Switch

Both disk arrays have split busses. Their option switches should be set as shown in FIGURE 2-2.

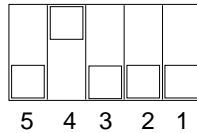

FIGURE 2-2 1x2 Option Switch Settings for StorEdge D1000 Disk Array

This will cause the disk drives in the StorEdge D1000 disk arrays to be numbered as shown in FIGURE 2-3 and FIGURE 2-4.

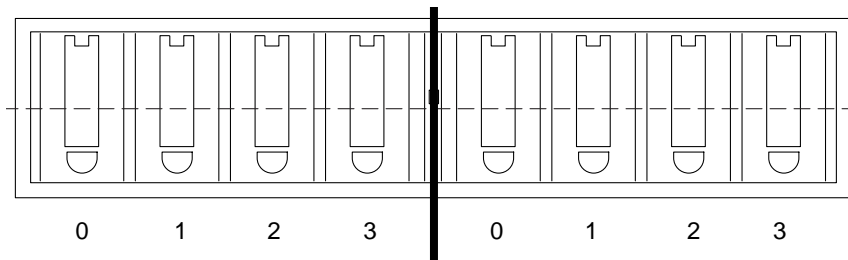

FIGURE 2-3 8-drive StorEdge D1000 SCSI ID (Split bus)

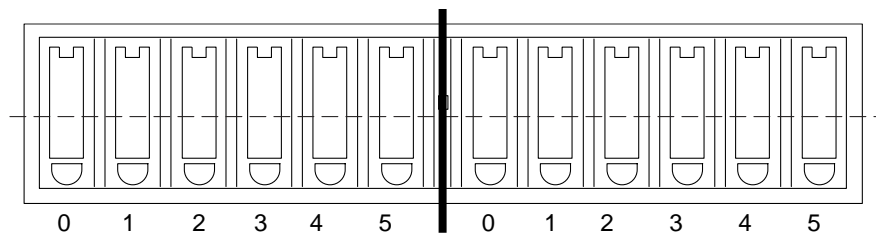

FIGURE 2-4 12-drive StorEdge D1000 SCSI Disk ID (Split bus)

2.1.1.2 Module ID Switch

Ensure that the module IDs for the StorEdge D1000 disk arrays are set according to .

1x2 Module ID Switch Settings

Disk array number	Module ID setting
2 (Top)	2
1 (Bottom)	1

Note – Since the top and bottom disk arrays are split between one controller module, the Module IDs will overlap. This may result in error messages while the host system is booting. The ASC/ASCQ codes for this error is 98/01 and the Sense Key is 6. These error messages are information only and will not impact system performance.

2.1.1.3 SCSI Jumper Cables and Terminators

The disk arrays should have differential SCSI terminators on the inside IN/OUT-1 and IN/OUT-2 SCSI connectors. This configuration is shown in FIGURE 2-11

2.1.2 1x5 Configuration

2.1.2.1 Option Switch

All StorEdge D1000 disk arrays in this configuration should have their option switches set as shown in FIGURE 2-5.

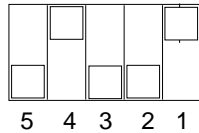

FIGURE 2-5 1x5 Option Switch Settings for StorEdge D1000 Disk Array

This will cause the disk drives in the StorEdge D1000 disk arrays to be numbered as shown in FIGURE 2-6 and FIGURE 2-7.

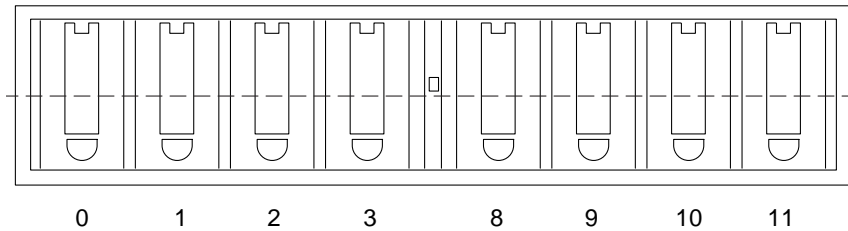

FIGURE 2-6 8-drive StorEdge D1000 SCSI ID (Single Bus)

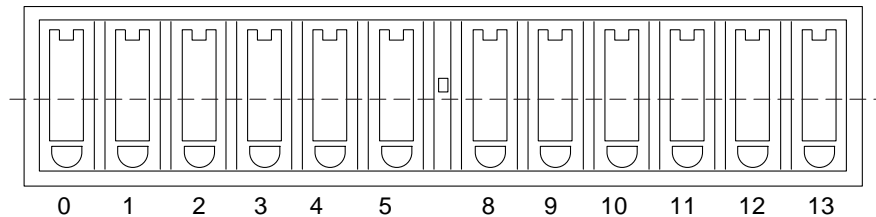

FIGURE 2-7 12-drive StorEdge D1000 SCSI ID (Single Bus)

2.1.2.2 Module ID Switch

Ensure that the module IDs for the StorEdge D1000 disk arrays are set according to TABLE 2-1.

TABLE 2-1 1x5 Module ID Switch Settings

Disk array number	Module ID setting
5 (Top)	5
4	4
3	3
2	2
1 (Bottom)	1

2.1.2.3 SCSI Jumper Cables and Terminators

All disk arrays in this configuration should have SCSI jumper cables between the middle SCSI connectors (IN/OUT-1 and IN/OUT-2) and a differential SCSI terminator in the far right SCSI connector (IN/OUT-2). This configuration is shown in FIGURE 2-15.

2.1.3 2x7 Configuration

2.1.3.1 Option Switch

The disk drives in each of the *top* four disk arrays in FIGURE 2-17 are on a single bus and should be set as described in Section 2.1.2.1 “Option Switch” on page 2-5.

The *bottom* three disk arrays have split busses. Their option switches should be set as shown in FIGURE 2-8.

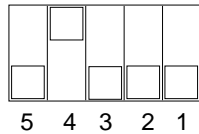

FIGURE 2-8 2x7 Option Switch Settings for StorEdge D1000 Disk Array

This will cause the disk drives in the StorEdge D1000 disk arrays to be numbered as shown in FIGURE 2-9 and FIGURE 2-10.

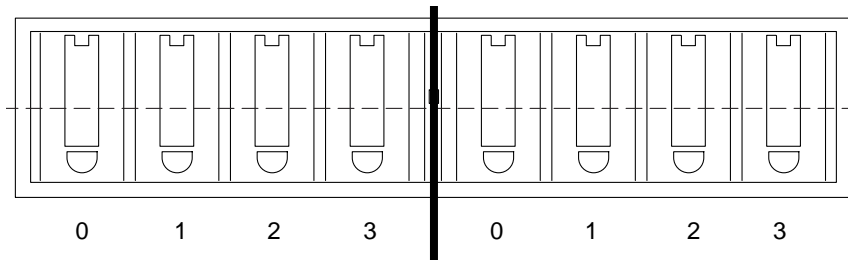

FIGURE 2-9 8-drive StorEdge D1000 SCSI ID (Split bus)

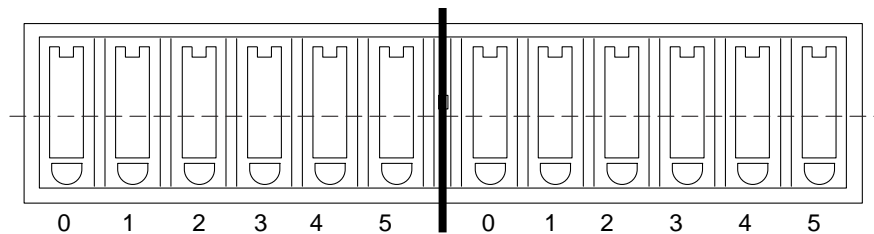

FIGURE 2-10 12-drive StorEdge D1000 SCSI Disk ID (Split bus)

2.1.3.2 Module ID Switch

Ensure that the module IDs for the StorEdge D1000 disk arrays are set according to TABLE 2-2.

TABLE 2-2 2x7 Module ID Switch Settings

Disk array number	Module ID setting
7 (Top)	5
6	4
5	5
4	4
3	3
2	2
1 (Bottom)	1

Facing the front of the expansion cabinet:

- controller module A controls the right side of disk arrays 1 through 3 and all of disk arrays 4 and 5.
- controller module B controls the left side of disk arrays 1 through 3 and all of disk arrays 6 and 7.

This configuration is shown in FIGURE 2-17.

2.1.3.3 SCSI Jumper Cables and Terminators

The *top* four disk arrays should have SCSI jumper cables between the middle SCSI connectors (IN/OUT-1 and IN/OUT-2) and a differential SCSI terminator in the far right SCSI connector (IN/OUT-2).

The *bottom* three disk arrays should have differential SCSI terminators on the inside IN/OUT-1 and IN/OUT-2 SCSI connectors. This configuration is shown in FIGURE 2-17.

2.1.4 3x15 Configuration

2.1.4.1 Option Switch

All disk arrays are on a single bus and should be set as described in Section 2.1.2.1 “Option Switch” on page 2-5.

2.1.4.2 Module ID Switch

Ensure that the module IDs for the StorEdge D1000 disk arrays are set according to TABLE 2-3 and TABLE 2-4.

TABLE 2-3 3x15 Module ID Switch Settings 2x7

Disk array number	Module ID setting
7 (Top)	5
6	4
5	3
4	2
3	1
2	1
1 (Bottom)	2

TABLE 2-4 3x15 Module ID Switch Settings 1x8

Disk array number	Module ID setting
8 (Top)	5
7	4
6	3
5	2
4	1
3	5
2	4
1 (Bottom)	3

In this configuration:

- controller module A controls disk arrays 1 and 2 in the 2x7 cabinet and disk arrays 1 through 3 in 1x8 cabinet (FIGURE 2-19)
- controller module B controls disk arrays 3 through 7 in 2x7 cabinet (FIGURE 2-20)
- controller module C controls disk arrays 4 through 8 in 1x8 cabinet (FIGURE 2-21)

2.1.4.3 SCSI Jumper Cables and Terminators

All disk arrays in this configuration should have SCSI jumper cables between the middle SCSI connectors (IN/OUT-1 and IN/OUT-2) and a differential SCSI terminator in the far right SCSI connector (IN/OUT-2).

2.2 1x2 Cabling

The 1x2 can be configured with the controller module either on top of or below the two disk arrays. Both configurations are described in this section.

2.2.1 SCSI Cabling

2.2.1.1 Cable Lengths

The following table shows the lengths of each SCSI cable connected to the drive connections on the controller module.

TABLE 2-5 Controller Module A (1x2)

SCSI Port Number	Cable Length	Part Number
1	.8m	530-1884-xx
2	.8m	530-1884-xx
3	.8m	530-1884-xx
4	.8m	530-1884-xx
5	Differential SCSI terminator	150-1890-xx

The inboard IN/OUT connectors on each disk array are terminated with a differential SCSI terminator, part number 150-1890-xx.

2.2.1.2 SCSI Connections

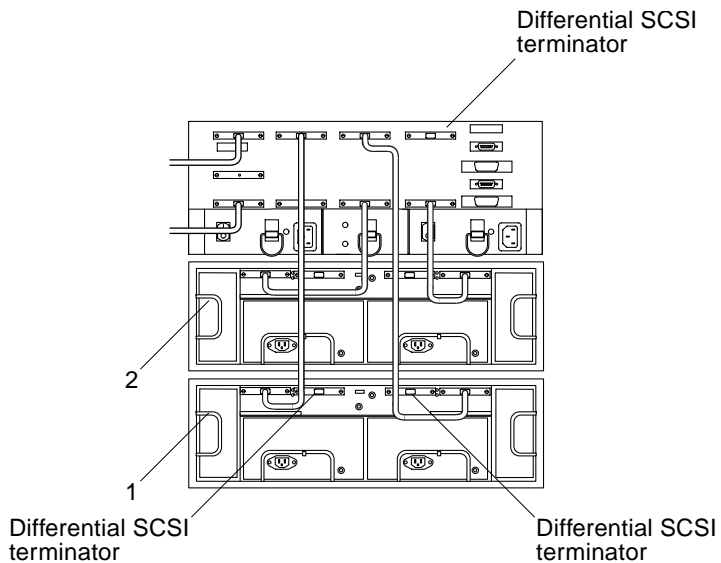

FIGURE 2-11 One A3000 Controller Module and Two D1000 Disk Arrays (SCSI)

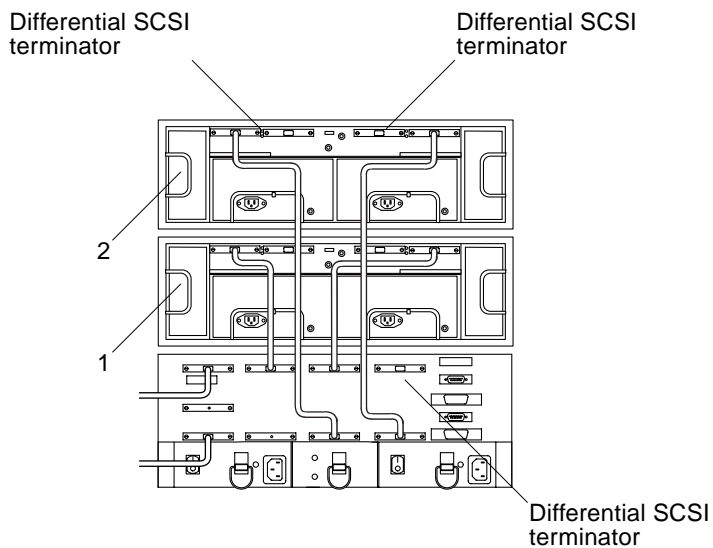

FIGURE 2-12 Two D1000 Disk Arrays and One A3000 Controller Module (SCSI)

2.2.2 Power Connections

Because the controller module must receive power after the disk arrays, connect the disk arrays to the first stage of the power sequencer and the controller module to the second. Two examples are shown below.

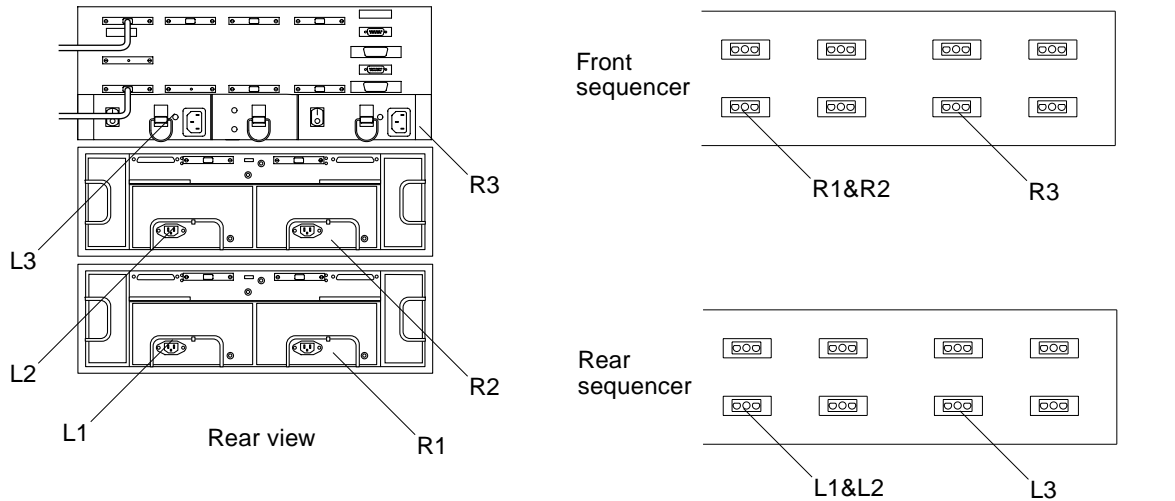

FIGURE 2-13 One A3000 Controller Module and Two D1000 Disk Arrays (Power)

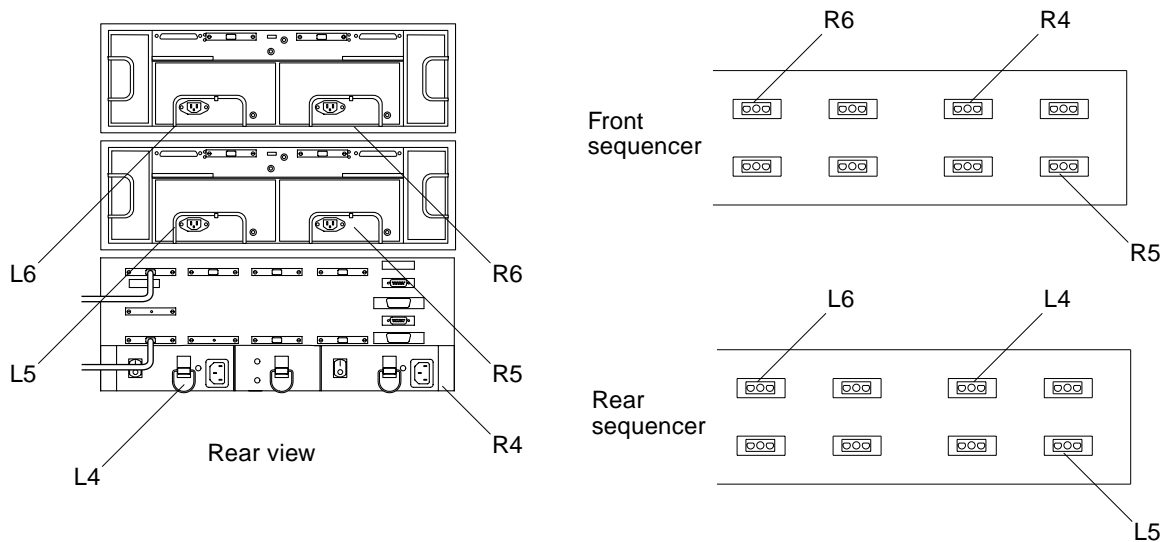

FIGURE 2-14 Two D1000 Disk Arrays and One A3000 Controller Module (Power)

2.3 1x5 Cabling

2.3.1 SCSI Cabling

2.3.1.1 Cable Lengths

The following table shows the lengths of each SCSI cable connected to the drive connections on the controller module.

TABLE 2-6 Controller Module A (1x5)

SCSI Port Number	Cable Length	Part Number
1	2m	530-1885-xx
2	2m	530-1885-xx
3	2m	530-1885-xx
4	2m	530-1885-xx
5	2m	530-1885-xx

The inboard IN/OUT connectors on each of the disk arrays are connected together using a 0.2m SCSI jumper cable, part number 530-1883-xx.

The outboard IN/OUT-2 connector on each disk array is terminated with a differential SCSI terminator, part number 150-1890-xx.

2.3.1.2 SCSI Connections

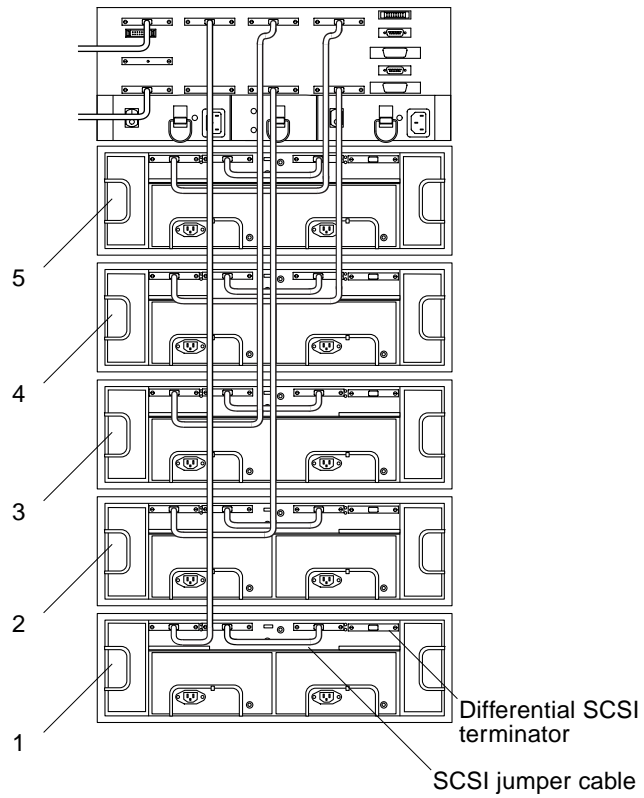

FIGURE 2-15 One A3000 Controller Module and Five D1000 Disk Arrays (SCSI)

2.3.2 Power Connections

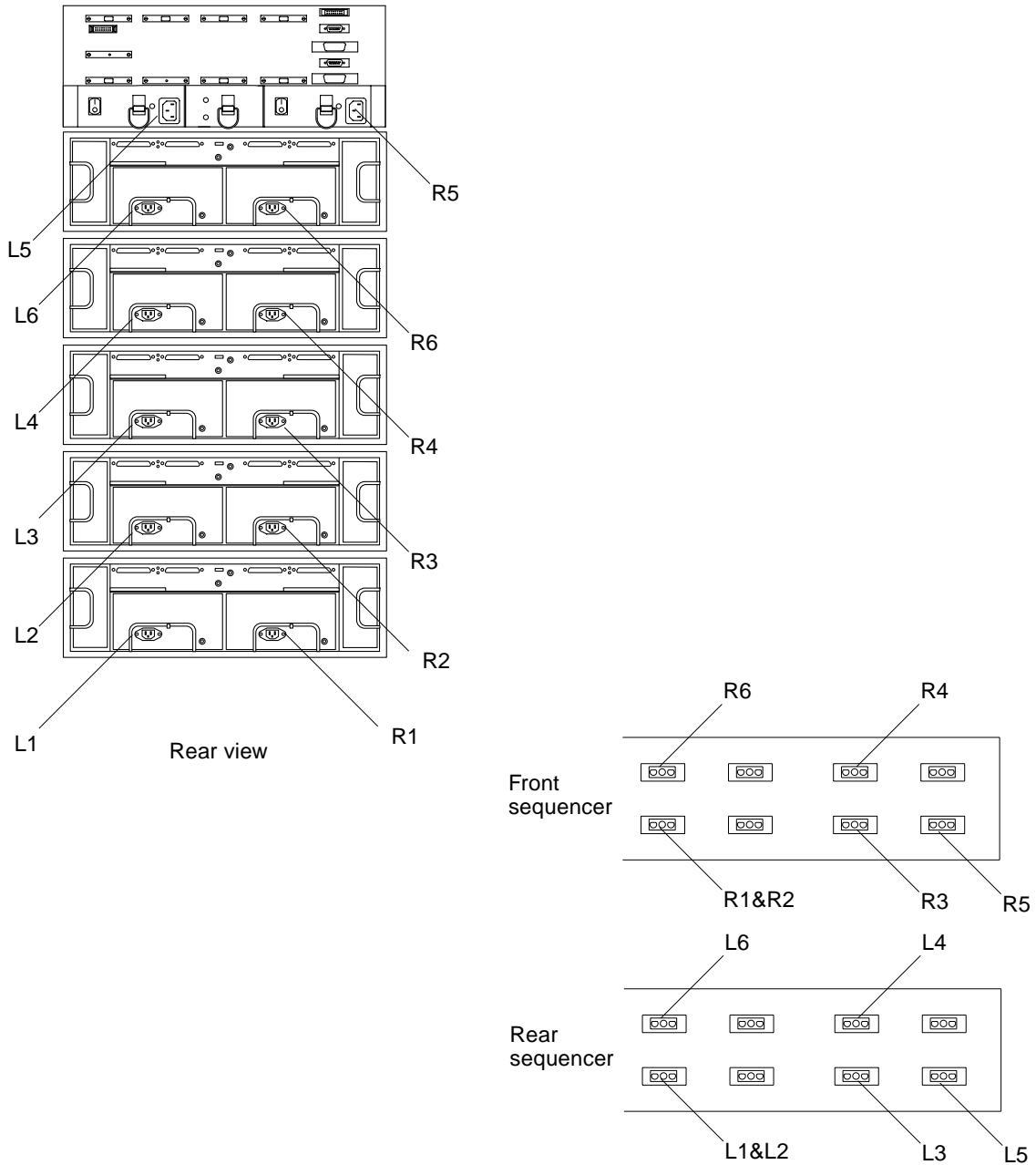

FIGURE 2-16 One A3000 Controller Module and Five D1000 Disk Arrays (Power)

2.4 2x7 Cabling

2.4.1 SCSI Cabling

2.4.1.1 Cable Lengths

The following tables show the lengths of each SCSI cable connected to the drive connections on the respective controller modules.

TABLE 2-7 Controller Module A (2x7)

SCSI Port Number	Cable Length	Part Number
1	.8m	530-1884-xx
2	.8m	530-1884-xx
3	.8m	530-1884-xx
4	2m	530-1885-xx
5	2m	530-1885-xx

TABLE 2-8 Controller Module B (2x7)

SCSI Port Number	Cable Length	Part Number
1	2m	530-1885-xx
2	.8m	530-1884-xx
3	.8m	530-1884-xx
4	2m	530-1885-xx
5	2m	530-1885-xx

The inboard IN/OUT connectors on each of the top four disk arrays are connected together using a 0.2m SCSI jumper cable, part number 530-1883-xx.

The inboard IN/OUT connectors on the bottom three disk arrays are terminated with differential SCSI terminators, part number 150-1890-xx.

2.4.1.2 SCSI Connections

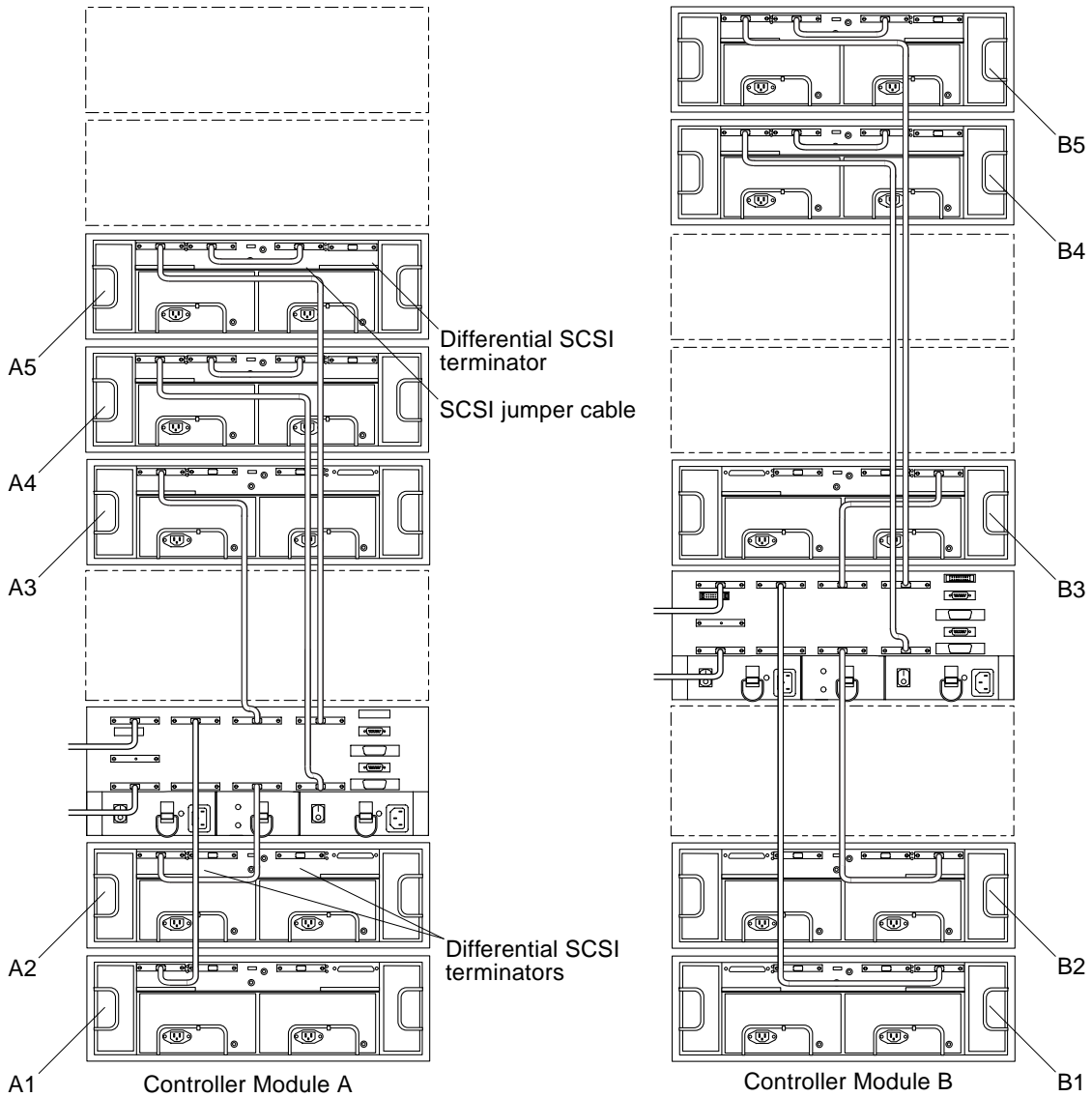

FIGURE 2-17 Two A3000 Controller Modules and Seven D1000 Disk Arrays (SCSI)

2.4.2 Power Connections

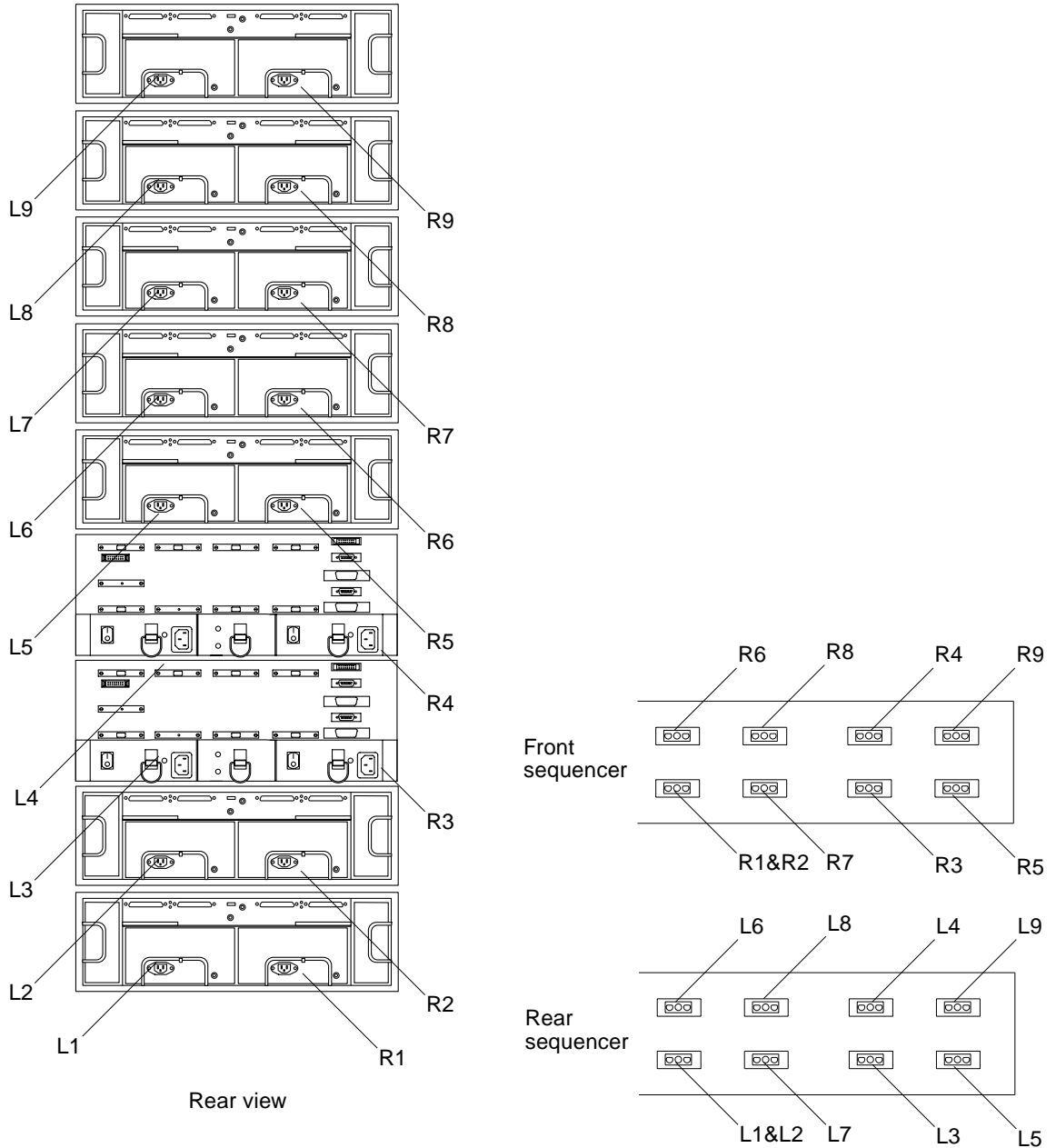

FIGURE 2-18 Two A3000 Controller Modules and Seven D1000 Disk Arrays (Power)

2.5 3x15 Cabling

This section contains information about SCSI and power connections for three StorEdge A3000 controller modules and fifteen StorEdge D1000 disk arrays in two StorEdge expansion cabinets.



Caution – The components in the expansion cabinets are configured as a single unit. Make sure that the serial numbers on each expansion cabinet match.

2.5.1 SCSI Cabling

2.5.1.1 Cable Lengths

The following tables show the lengths of each SCSI cable connected to the drive connections on the respective controller modules.

TABLE 2-9 Controller Module A (3x15)

SCSI Port Number	Cable Length	Part Number
1	.8m	530-1884-xx
2	.8m	530-1884-xx
3	4m	530-2352-xx
4	4m	530-2352-xx
5	4m	530-2352-xx

TABLE 2-10 Controller Module B (3x15)

SCSI Port Number	Cable Length	Part Number
1	.8m	530-1884-xx
2	.8m	530-1884-xx
3	2m	530-1885-xx
4	2m	530-1885-xx
5	2m	530-1885-xx

TABLE 2-11 Controller Module C (3x15)

SCSI Port Number	Cable Length	Part Number
1	.8m	530-1884-xx
2	.8m	530-1884-xx
3	2m	530-1885-xx
4	2m	530-1885-xx
5	2m	530-1885-xx

The inboard IN/OUT connectors on each of the disk arrays are connected together using a 0.2m SCSI jumper cable, part number 530-1883-xx.

The outboard IN/OUT-2 connector on each disk array is terminated with a differential SCSI terminator, part number 150-1890-xx.

2.5.1.2 SCSI Connections for Controller Module A

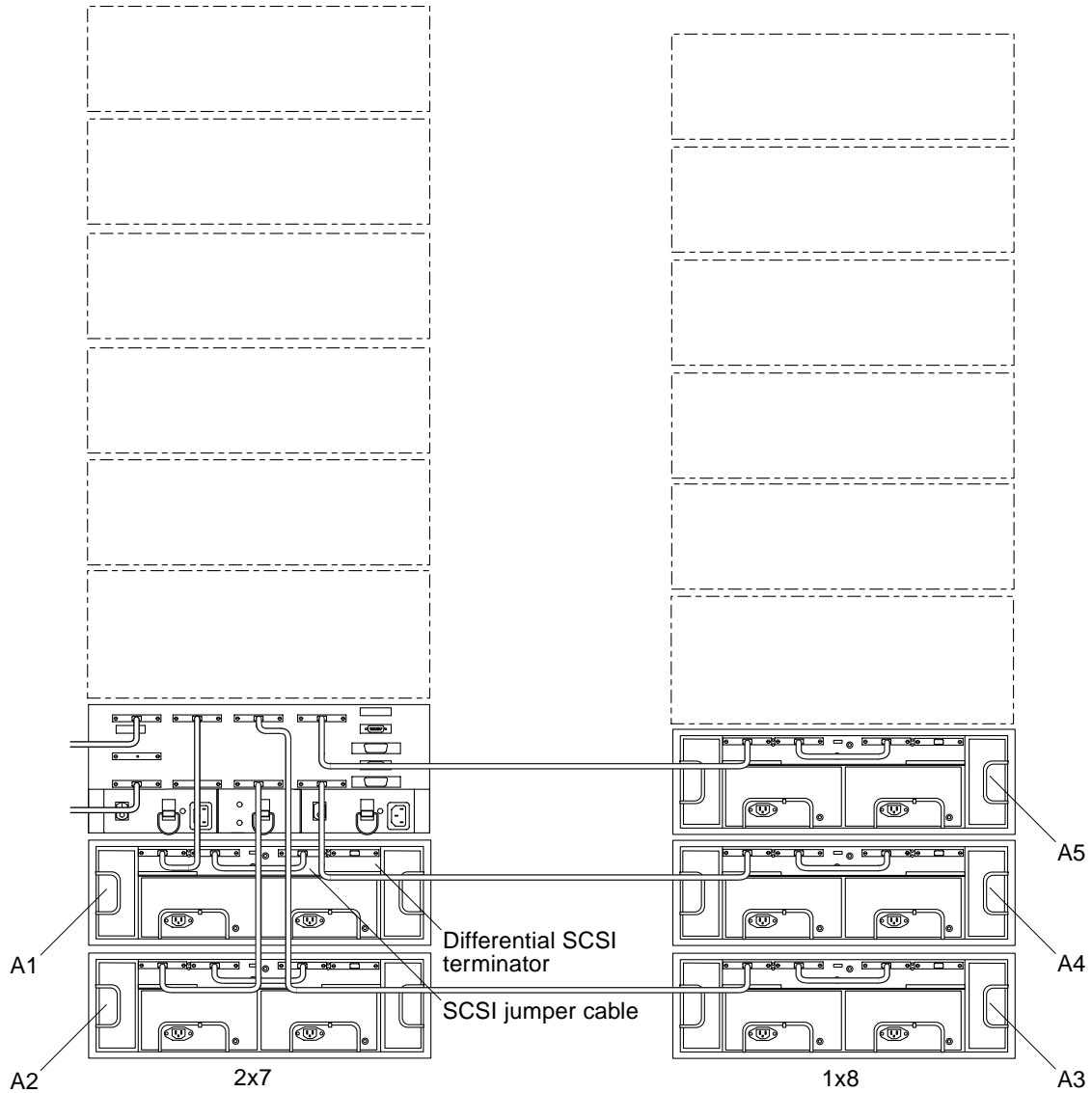

FIGURE 2-19 3x15 (Controller Module A)

2.5.1.3 SCSI Connections for Controller Module B

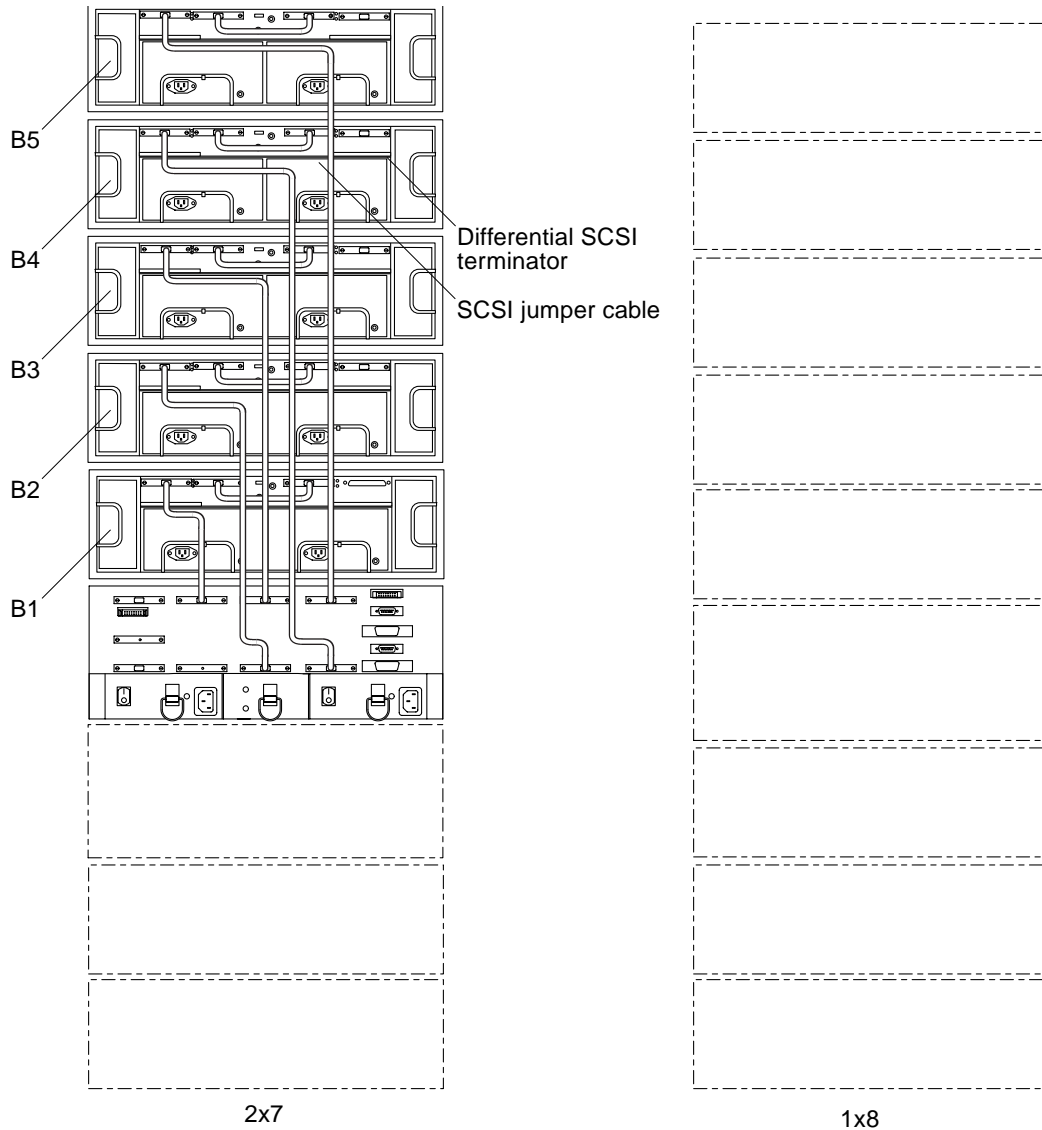

FIGURE 2-20 3x15 (Controller Module B)

2.5.1.4 SCSI Connections for Controller Module C

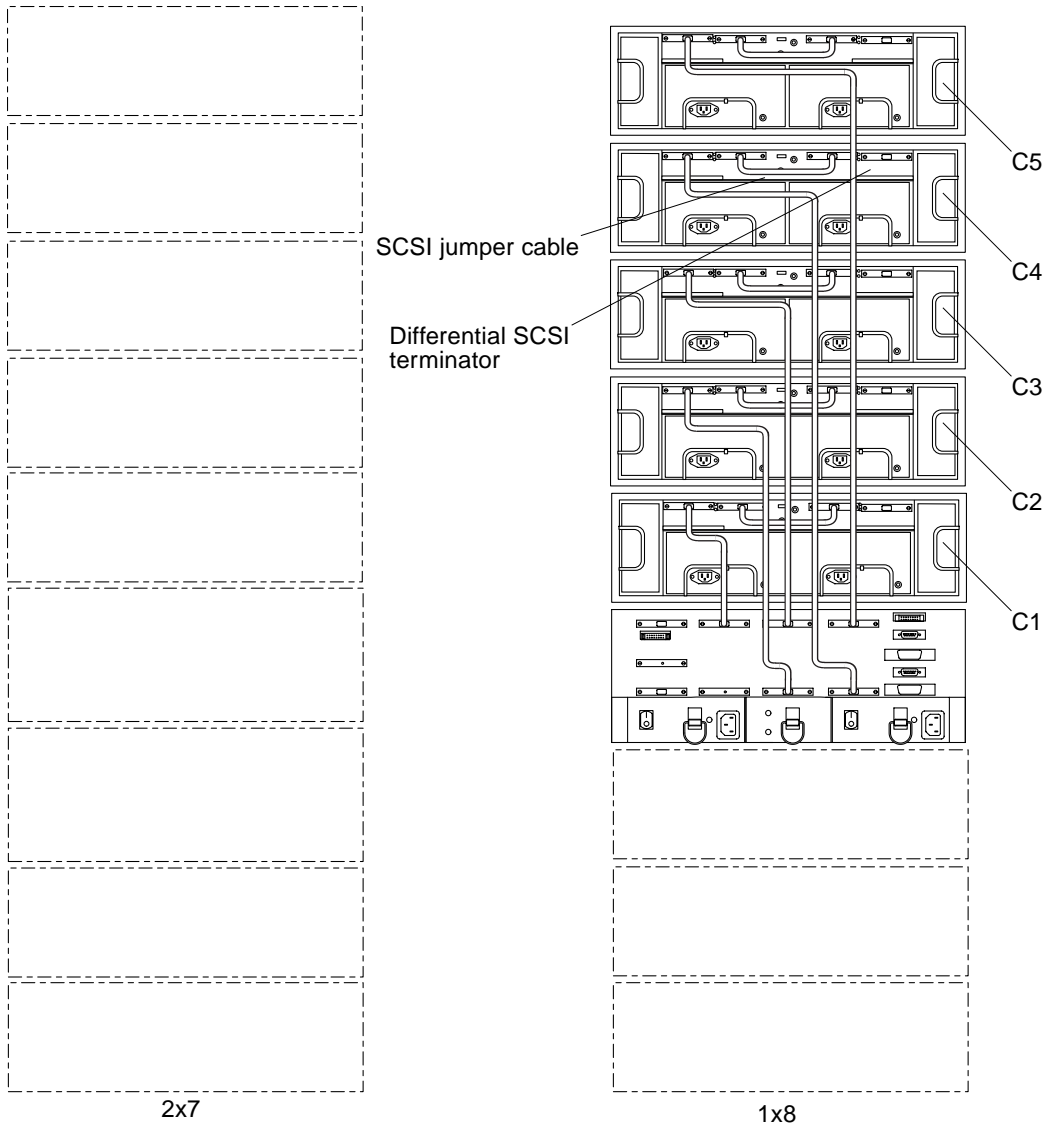

FIGURE 2-21 3x15 (Controller Module C)

2.5.2 Power Connections

2.5.2.1 Power Sequencer Interconnections

The front and rear power sequencers in the 2x7 cabinet and the 1x8 cabinet must be interconnected. Make sure an interconnect cable (part number 530-2235-xx) is connected between the OUT on the front sequencer in 2x7 cabinet and the IN on the front sequencer in 1x8 cabinet (FIGURE 2-22). Make sure that the rear sequencers are likewise connected.

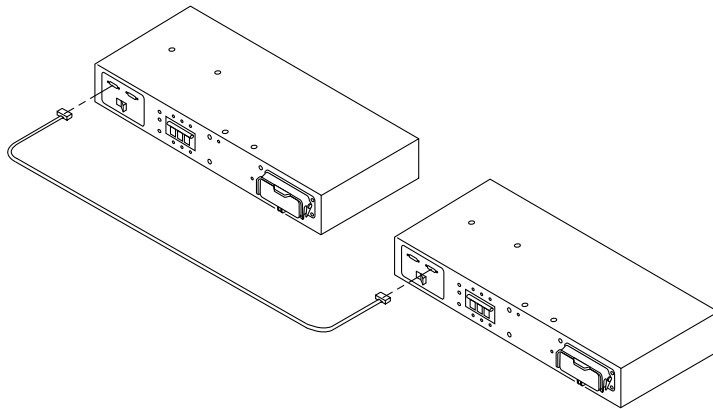

FIGURE 2-22 Connecting the Power Sequencers

2.5.3 Connecting to AC Power Source

Each of the AC power cords connected to the expansion cabinets should be on independent circuit breakers.

To ensure proper redundancy, if independent circuit breaker boxes or AC power sources are used, power cords from the same expansion cabinet should be connected to different circuit breaker boxes or AC power sources.



Caution – You must ensure that the second rack will not lose power without the first. Data loss is likely to occur if this happens. DO NOT configure the 3x15 expansion cabinets as shown in FIGURE 2-23 and FIGURE 2-24. Consult with an electrician if you do not understand the schematics in the figures.

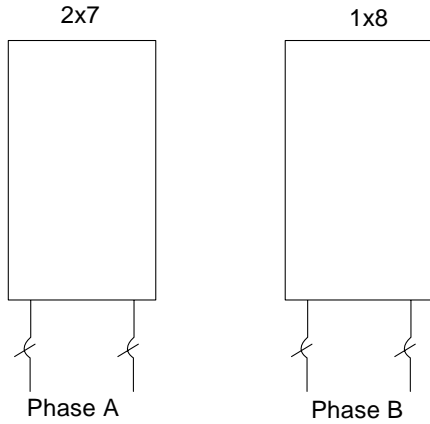

FIGURE 2-23 Power Connections to Avoid (Different Phases)

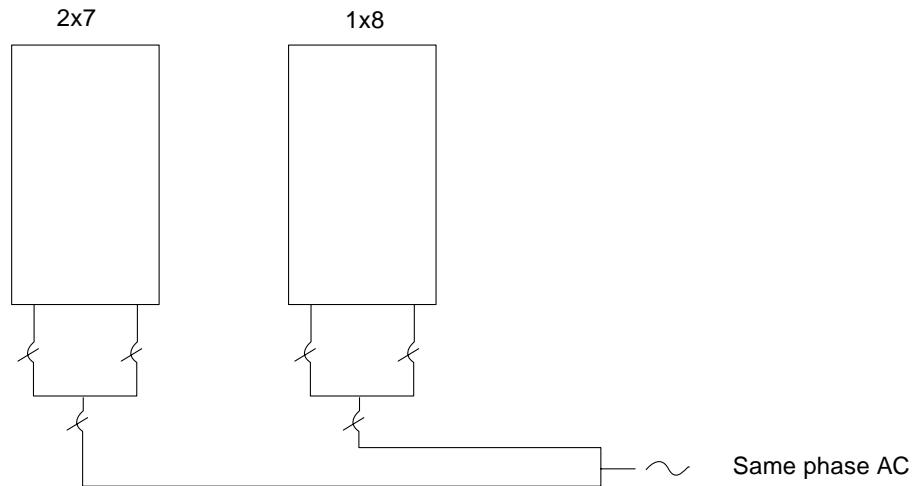

FIGURE 2-24 Power Connections to Avoid (Same Phase)

2.5.4 Power Connections

The power connections for 2x7 cabinet are the same as those in the standard 2x7 expansion cabinet (FIGURE 2-18).

The power connections for the 1x8 cabinet are shown in FIGURE 2-25.

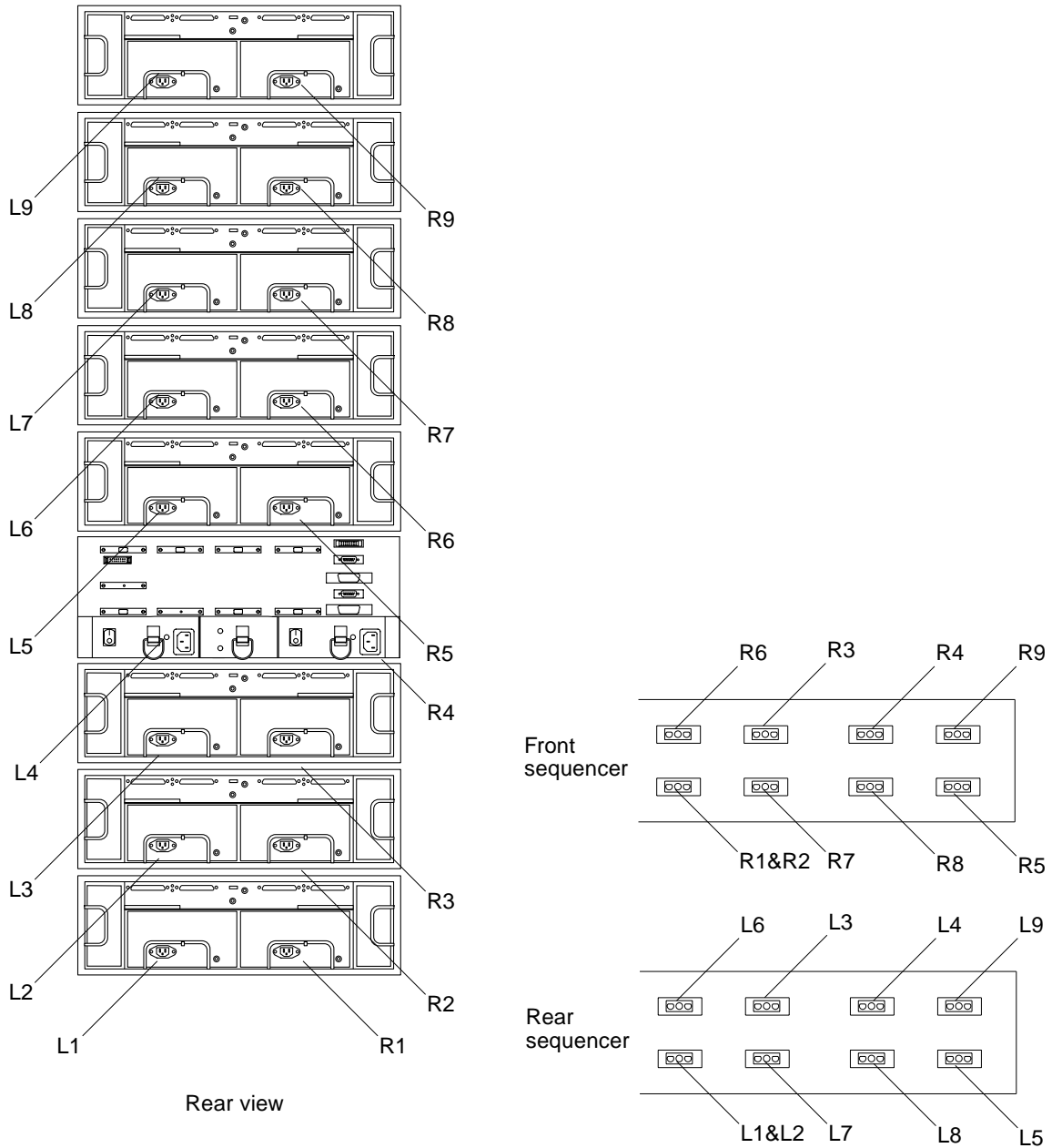

FIGURE 2-25 One A3000 Controller Modules and Eight D1000 Disk Arrays (Power)

