

# Netra™ t1 Model 105 Installation Guide

## Part 1

### Safety Precautions

For your protection, observe the following safety precautions when setting up your equipment:

- Follow all cautions and instructions marked on the equipment.
- Never push objects of any kind through openings in the equipment. Dangerous voltages may be present. Conductive foreign objects can produce a short circuit that could cause fire, electric shock, or damage to your equipment.

### Symbols

The following symbols may appear in this poster:



**Caution** – There is a risk of personal injury and equipment damage. Follow the instructions.



**Caution** – Hazardous voltages are present. To reduce the risk of electric shock and danger to personal health, follow the instructions.

### Modifications to Equipment

Do not make mechanical or electrical modifications to the equipment. Sun Microsystems is not responsible for the regulatory compliance of a modified product.



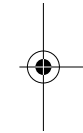
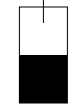
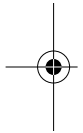
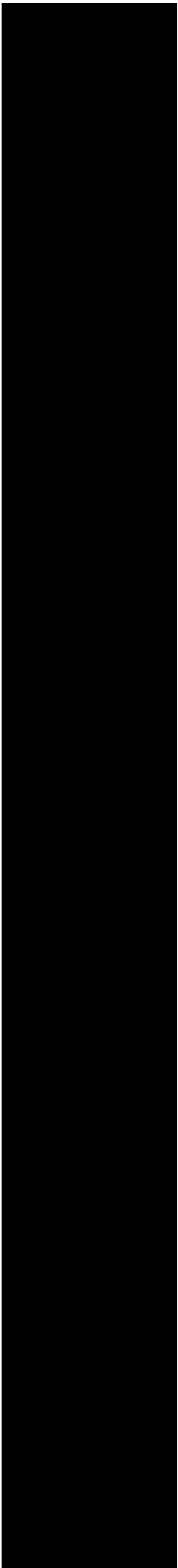

Blue spot plate



# Setup

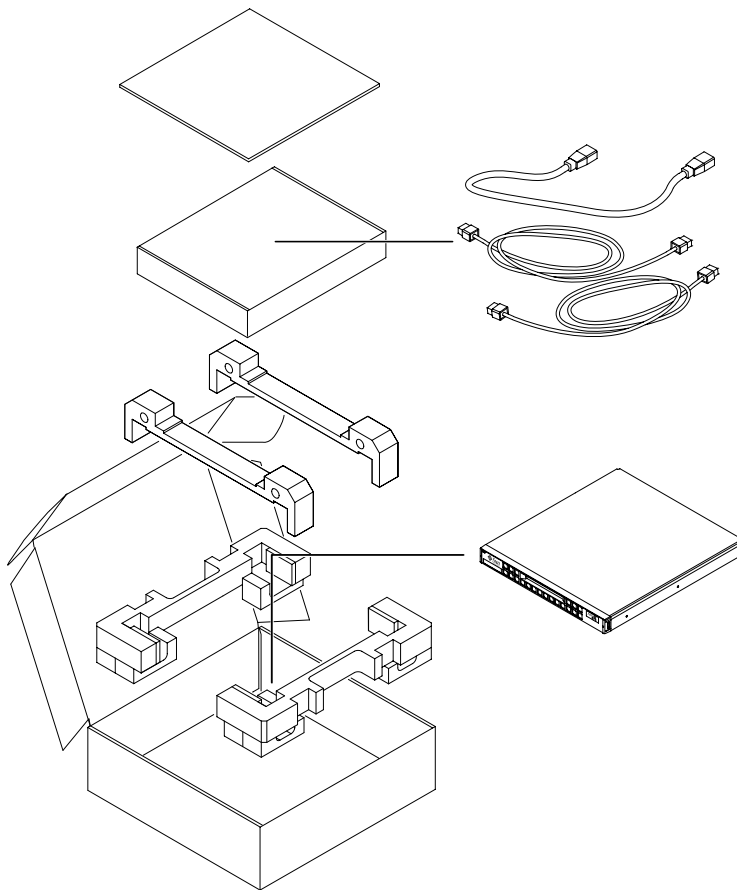

\* Contents may vary

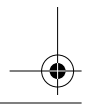
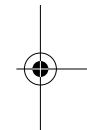
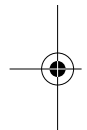

Black spot plate

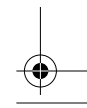

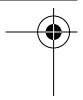

1

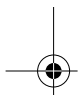
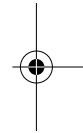
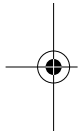
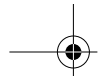

Blue spot plate

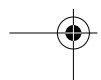
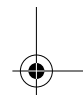
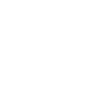



# Rack Mounting

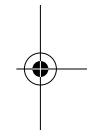
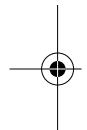
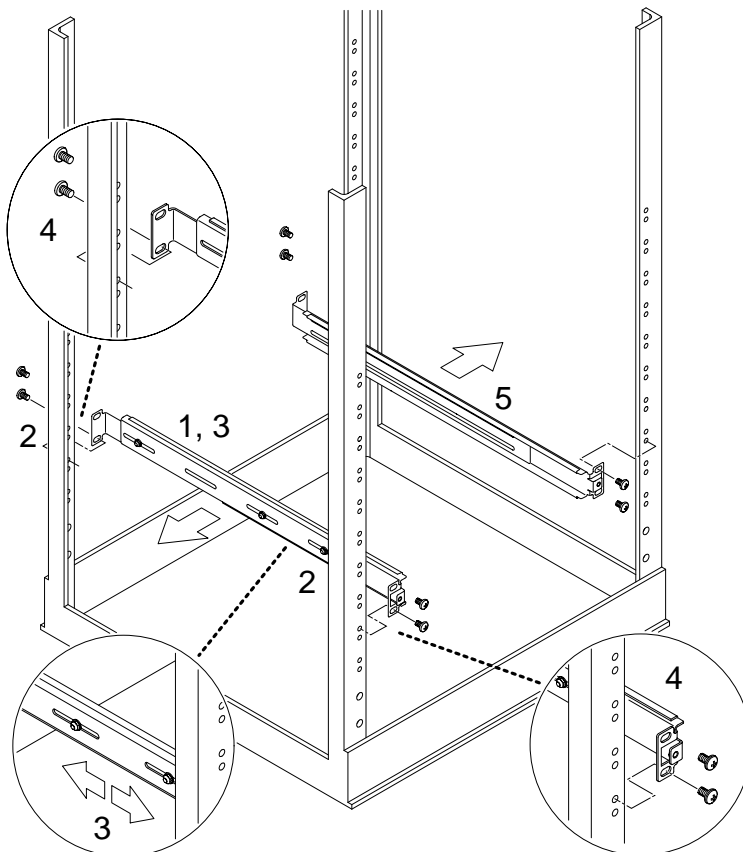

1 Slacken the M4 nuts on the left bracket. 2 Adjust the bracket to fit the rack. The ends of the bracket must be outside the rack. 3 Move the brackets so that the studs are in suitable slots and tighten the nuts. 4 Fasten the screws on both ends of the bracket. 5 Repeat for the right bracket.

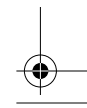
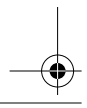

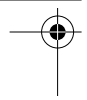

2

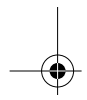
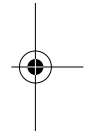
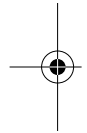
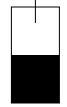
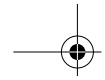



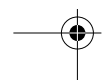
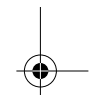

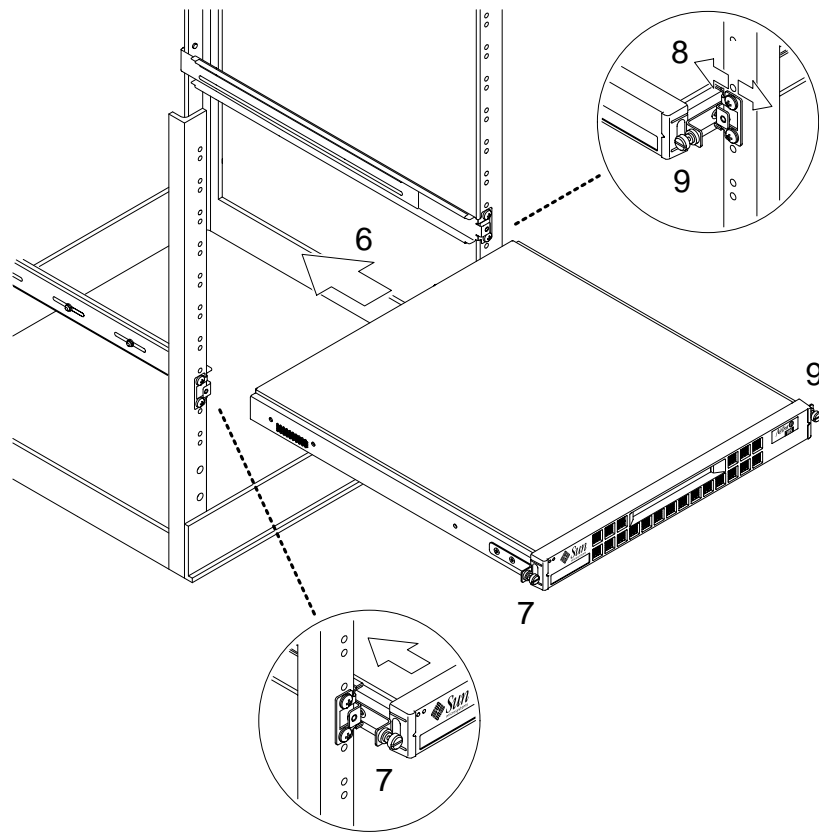
Blue spot plate





**6** Slide the unit into the rack. **7** Fasten the screws on the left side of the unit. **8** Adjust the bracket on the right side of the unit. **9** Fasten the screws on the right side of the unit. It may be necessary to readjust the brackets fixings in order to align the system as required.

-  **Caution** - Do not block or cover the openings of your Sun product. Never place a Sun product near a radiator or heat register. Failure to follow these guidelines can cause overheating and affect the reliability of your Sun product.
-  **Caution** - The workplace-dependent noise level defined in DIN 45 635 Part 1000 must be 70Db(A) or less.
-  **Caution** - If installed in a closed or multi-unit rack assembly, the operating ambient temperature of the rack environment may exceed the room ambient. Ensure that rack environment ambient temperature does not exceed 55 degrees Celsius (130 degrees Fahrenheit).
-  **Caution** - Mounting of the equipment in a rack or cabinet should be such that a hazardous condition is not created due to uneven mechanical loading or weight distribution.
-  **Caution** - Ensure that the connection of multiple system units to the circuit does not overload the the supply overcurrent protection or supply wiring. Consider the Sun product nameplate electrical ratings when determining the correct branch circuit rating for your installation.

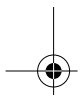
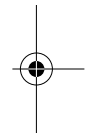
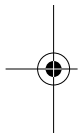
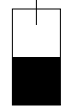
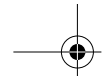
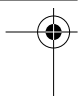

Blue spot plate

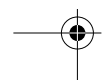
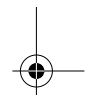



# Connecting the System

---

**On** - Applies AC power to the system.

---



---

**Standby** - The On/Standby switch is in the *standby* position.

---

Safety status of I/O connections comply to SELV requirements.

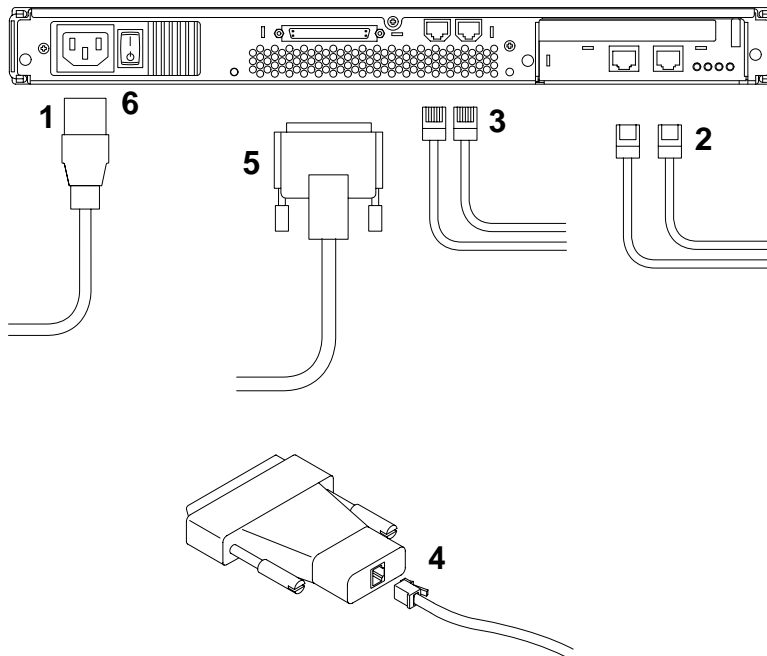

1 Connect the Netra t1 Model 105 AC power cord. 2 Connect the two Ethernet devices. 3 Connect up to two serial devices. You must connect a console to one serial port. You can also connect to the LOMlite device for remote power on/off via the port marked LOM/Serial A. See the *Netra t1 LOMlite User's Guide* for details. 4 If required, insert the serial cable for external devices into the adapter. 5 If required, connect a SCSI adapter to the SCSI cable. 6 Turn power supply switch on.

---

**Note** - The cables and adapters meet the requirements for the Netra t1 Model 105 RJ-45 and AUX ports.

---



3

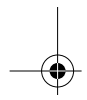
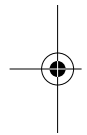

Blue spot plate

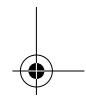



# Power Cord Connection



---

**Caution** – Sun products are designed to work with single-phase power systems having a grounded neutral conductor. To reduce the risk of electric shock, do not plug Sun products into any other type of power system. Contact your facilities manager or a qualified electrician if you are not sure what type of power is supplied to your building.

---



---

**Caution** – Not all power cords have the same current ratings. Household extension cords do not have overload protection and are not meant for use with computer systems. Do not use household extension cords with your Sun product.

---



---

**Caution** – Your Sun product is shipped with a grounding type (three-wire) power cord. To reduce the risk of electric shock, always plug the cord into a grounded outlet.

---

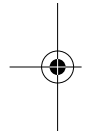

---

**Caution** – The power switch of this product functions as a standby device only. The power cord serves as the primary disconnect device for the system. Be sure to plug the power cord into a grounded power outlet that is nearby the system and is readily accessible. Do not connect the power cord when the power supply has been removed from the system chassis.

---



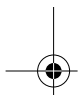
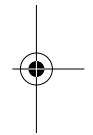
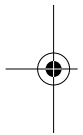
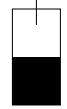
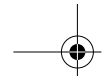
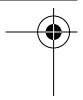

Blue spot plate

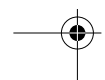
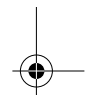

# Installing Options



## Electrostatic Discharge

This system contains electronic parts that are extremely sensitive to static electricity. Do not touch any metal parts. Wear a wrist strap.

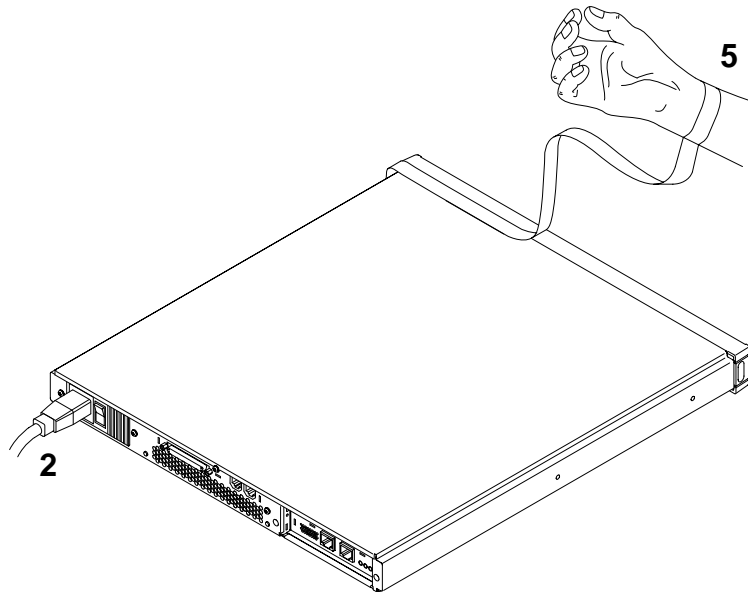

- 1 Shut down Solaris™ from the console.
  - 2 Turn the power supply switch off.
  - 3 Disconnect the AC power cord.
  - 4 Disconnect any other cables.
  - 5 Remove the system from the rack and place at an ESD station.
- 5 Attach the wrist strap to the attachment point on the station.



**Caution** - Do not touch any metal parts.



4

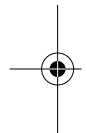

Blue spot plate





**Caution** – Do not operate Sun products without the top cover in place. Failure to take this precaution may result in personal injury and system damage.

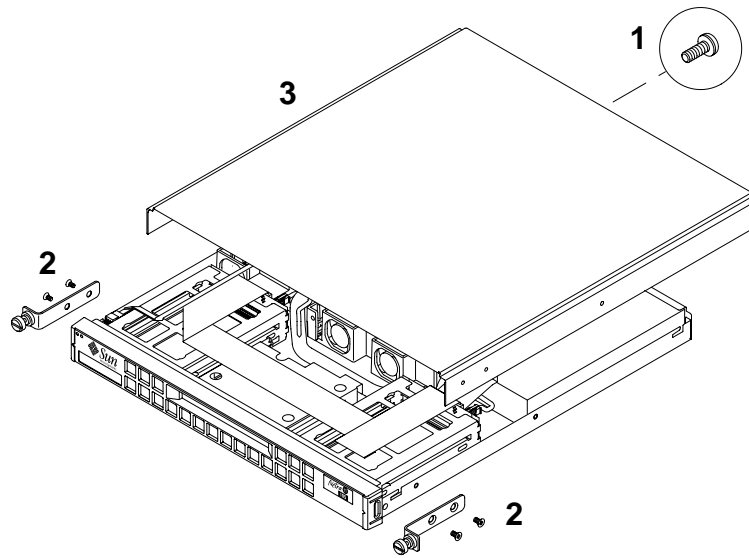

1 Remove the cover screw using a Phillips No. 2 screwdriver. 2 Remove the rack brackets, if fitted. 3 Slide the cover to rear and lift. 4 Reverse the procedure to replace the cover. See panel 9 for more information about disassembling the system when required to install options.

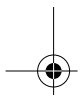
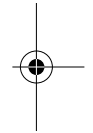
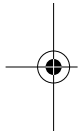
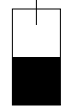
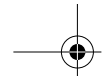
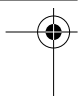

Blue spot plate

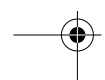
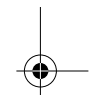



# Installing PCI Cards

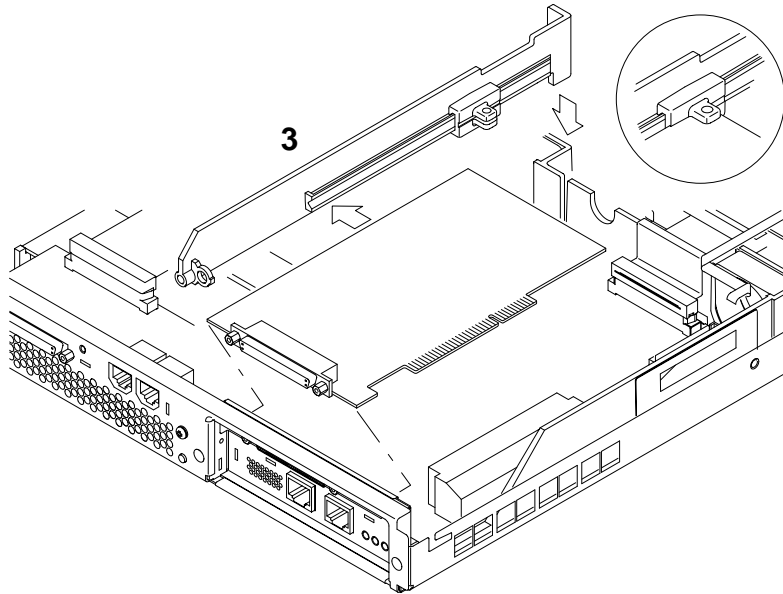

See panel 9 for an illustration of all removable parts.

**1** Remove the system from the rack (see panel 4). **2** Remove the cover (see panel 4). **3** Push the slide in the mid-baffle away from the edge of the PCI card and lift out the baffle. **4** Remove the blanking panel or previous PCI card. **5** Slide the PCI card into place. **6** Insert the mid-baffle. **7** Push the slide in the baffle forward to hold the PCI card in place. **8** Replace the other components in the reverse order to that in which you removed them.



5

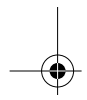
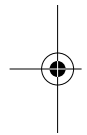
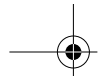

Blue spot plate

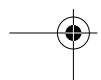
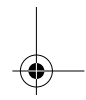

# Installing Additional Memory

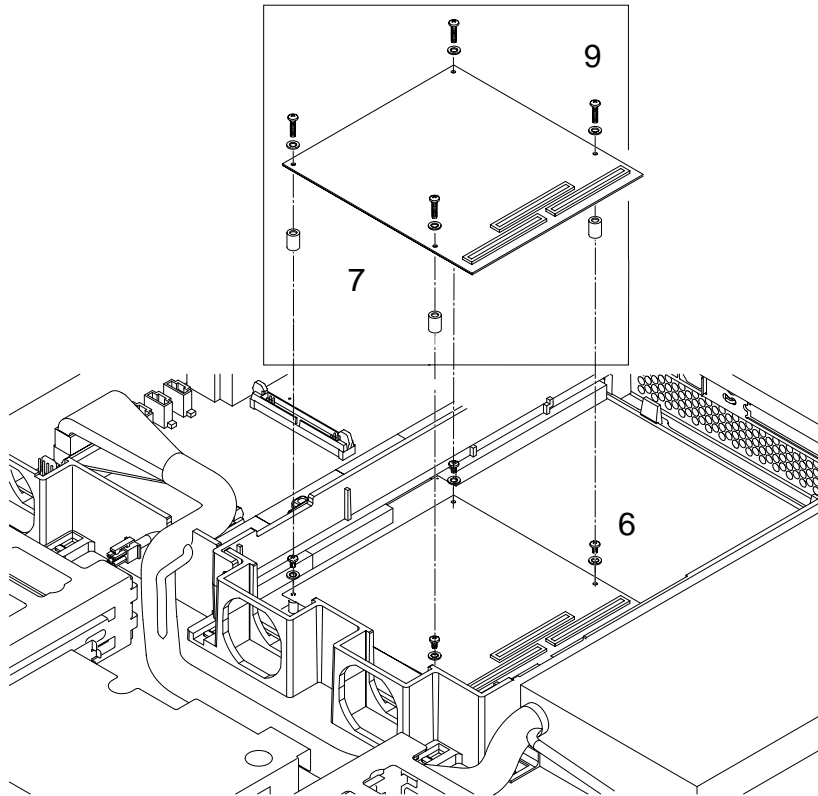

There is one memory board in the shipped system. You can upgrade it and install an additional memory board.

See panel 9 for an illustration of all removable parts.

1 Remove the system from the rack (see panel 4). 2 Remove the cover (see panel 4). 3 Slide and lift off the processor cover. 4 Unplug the serial and SCSI cables from the rear I/O board. 5 Remove the processor cover. 6 Remove the screws and washers from the base memory board. 7 Position the new spacers over the screw holes. 8 Position the additional memory board above the base memory board so that the connectors line up. 9 Insert the new, longer screws through both boards and the intervening spacers. See the memory board documentation for further information. 10 Replace the other components in the reverse order to that in which you removed them.

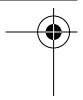

# 6

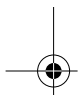
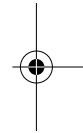
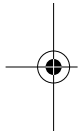
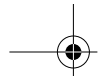

Blue spot plate

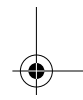
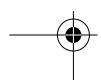
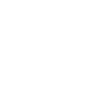

# Installing Disk Drives

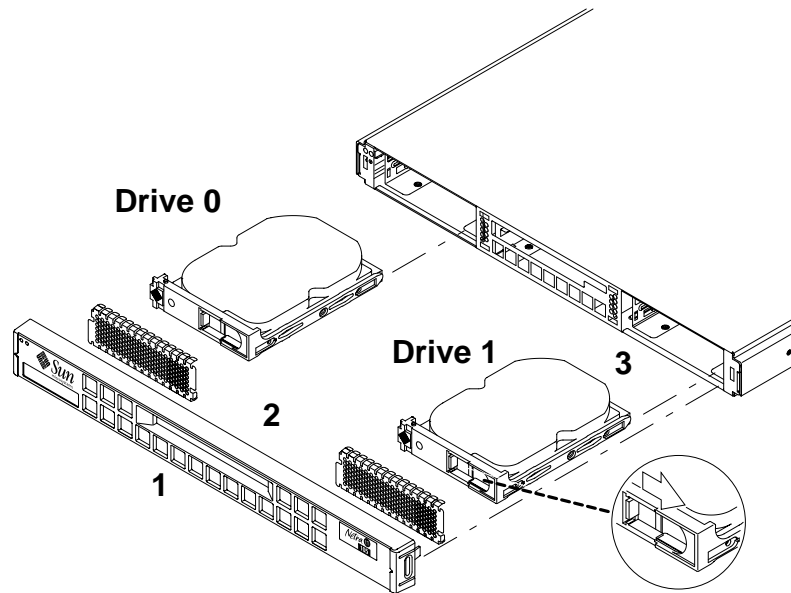

1 Remove the front bezel by pressing the latch at either end. 2 Lever the grilles out. 3 Slide the disk drive(s) in to the front of the system. 4 Replace the grilles and front bezel.

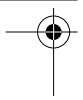

7

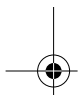
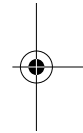
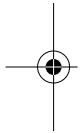
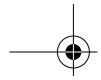

Blue spot plate

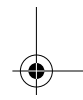
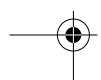



We are interested in improving our documentation and welcome your comments and suggestions. You can email your comments to us at:

[docfeedback@sun.com](mailto:docfeedback@sun.com)

Please include the part number of your document in the subject line of your email.

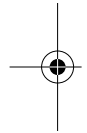

Copyright 1999 Sun Microsystems, Inc. All rights reserved. Use is subject to license terms. Third-party software, including font technology, is copyrighted and licensed from Sun suppliers. Sun, Sun Microsystems, the Sun Logo, Ultra, AnswerBook, ShowMe How, and Solaris are trademarks or registered trademarks of Sun Microsystems, Inc. in the U.S. and other countries. **RESTRICTED RIGHTS:** Use, duplication, or disclosure by the U.S. Government is subject to restrictions of FAR 52.227-14(g)(2)(6/87) and FAR 52.227-19(6/87), or DFAR 252.227-7015(b)(6/95) and DFAR 227.7202-3(a).

Copyright 1999 Sun Microsystems, Inc. Alle Rechte vorbehalten. Die Verwendung unterliegt Lizenzvereinbarungen. Die Software von Drittparteien, einschließlich Schriftarttechnologien, ist urheberrechtlich geschützt und von Zulieferern von Sun lizenziert. Sun, Sun Microsystems, das Sun-Logo, Ultra, AnswerBook, ShowMe How, sowie Solaris sind Warenzeichen oder in den USA und anderen Ländern eingetragene Warenzeichen von Sun Microsystems, Inc. **INGESCHRÄNKTE RECHTE:** Verwendung, Vervielfältigung oder Offenlegung durch die Regierung der USA unterliegen Einschränkungen gem. FAR 52.227-14(g)(2)(6/87) und FAR 52.227-19(6/87) bzw. DFAR 252.227-7015(b)(6/95) und DFAR 227.7202-3(a).

Copyright 1999 Sun Microsystems, Inc. Alla rättigheter förbehållna. För endast användas enligt licensvillkoren. Program från tredjepartsleverantörer, inklusive teckensnittsteknologin, är skyddade av copyright och licensierad från Suns leverantörer. Sun, Sun Microsystems, Suns logotyp, Ultra, AnswerBook, ShowMe How, och Solaris är varumärken eller registrerade varumärken som tillhör Sun Microsystems, Inc., i USA och i andra länder. **BEGRÄNSADE RÄTTIGHETER:** Användning, duplicering eller yppande av USAs regering är föremål för restriktioner enligt FAR 52.227-14(g)(2)(6/87) och FAR 52.227-19(6/87), eller DFAR 252.227-7015(b)(6/95) och DFAR 227.7202-3(a).

Part number: 806-1551-10  
Revision A, July 1999

Sun Microsystems Computer Company • 901 San Antonio Road • Palo Alto, CA 94303-4900 USA  
• 1 650-960-1300 • Fax 1 650-969-9131



Black spot plate



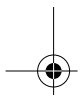
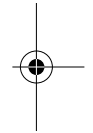
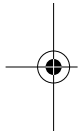
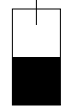
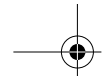
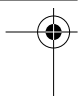

Blue spot plate

