

# IRIX® Admin: Disks and Filesystems

007-2825-012

---

## CONTRIBUTORS

Written by Susan Ellis, Steven Levine

Illustrated by Dany Galgani

Production by Glen Traefald

---

## COPYRIGHT

© 1999-2003, Silicon Graphics, Inc. All rights reserved; provided portions may be copyright in third parties, as indicated elsewhere herein. No permission is granted to copy, distribute, or create derivative works from the contents of this electronic documentation in any manner, in whole or in part, without the prior written permission of Silicon Graphics, Inc.

---

## LIMITED RIGHTS LEGEND

The electronic (software) version of this document was developed at private expense; if acquired under an agreement with the USA government or any contractor thereto, it is acquired as "commercial computer software" subject to the provisions of its applicable license agreement, as specified in (a) 48 CFR 12.212 of the FAR; or, if acquired for Department of Defense units, (b) 48 CFR 227-7202 of the DoD FAR Supplement; or sections succeeding thereto. Contractor/manufacturer is Silicon Graphics, Inc., 1600 Amphitheatre Pkwy 2E, Mountain View, CA 94043-1351.

---

## TRADEMARKS AND ATTRIBUTIONS

Silicon Graphics, SGI, the SGI logo, XFS, CHALLENGE, Indy, IRIX and IRIS are registered trademarks, Extent File System, Origin2000, IRIS InSight, Origin, and REACT are trademarks of Silicon Graphics, Inc., in the United States and/or other countries worldwide.

Macintosh is a trademark of Apple Computer, Inc. EXABTYE is a trademark of EXABTYE Corporation. FLEXIm is a trademark of Globetrotter Software, Inc. IBM is a trademark of International Business Machines Corporation. NetWorker is a registered trademark of Legato Systems, Inc. NFS is a registered trademark of Sun Microsystems. UNIX is a registered trademark in the United States and other countries, licensed exclusively through X/Open Company, Ltd.

Cover design by Sarah Bolles, Sarah Bolles Design, and Dany Galgani, SGI Technical Publications

---

# What's New in This Guide

## New Features Documented

For the IRIX 6.5.21 release, small technical corrections and updates have been made throughout this manual.



---

## Record of Revision

|     |  |
|-----|--|
| 005 | July 1999<br>Incorporates information for the IRIX 6.5.5 release       |
| 006 | December 1999<br>Incorporates information for the IRIX 6.5.7 release   |
| 007 | July 2000<br>Incorporates information for the IRIX 6.5.9 release       |
| 008 | June 2001<br>Incorporates information for the IRIX 6.5.13 release      |
| 009 | September 2001<br>Incorporates information for the IRIX 6.5.14 release |
| 010 | January 2002<br>Incorporates information for the IRIX 6.5.15 release   |
| 011 | October 2002<br>Incorporates information for the IRIX 6.5.18 release   |
| 012 | June 2003<br>Incorporates information for the IRIX 6.5.21 release      |



---

# Contents

|   |          |
|---|----------|
| <b>Figures</b> . . . . .                                    | xv       |
| <b>Tables</b> . . . . .                                     | xvii     |
| <b>Examples</b> . . . . .                                   | xix      |
| <b>IRIX Admin Manual Set</b> . . . . .                      | xxi      |
| <b>About This Guide.</b> . . . . .                          | xxiii    |
| What This Guide Contains . . . . .                          | xxiii    |
| Conventions Used in This Guide . . . . .                    | xxiv     |
| How to Use This Guide . . . . .                             | xxvi     |
| Product Support . . . . .                                   | xxvii    |
| Additional Resources . . . . .                              | xxvii    |
| Reader Comments . . . . .                                   | xxviii   |
| <b>1. Disk Concepts</b> . . . . .                           | <b>1</b> |
| Disk Drives on Silicon Graphics Systems . . . . .           | 2        |
| Physical Disk Structure . . . . .                           | 3        |
| Disk Partitions . . . . .                                   | 4        |
| System Disks, Option Disks, and Partition Layouts . . . . . | 6        |
| Partition Types . . . . .                                   | 11       |
| Volume Headers . . . . .                                    | 12       |
| Device Files . . . . .                                      | 14       |
| Block and Character Devices . . . . .                       | 15       |
| Device Permissions and Owner . . . . .                      | 16       |
| Major and Minor Devices . . . . .                           | 16       |
| Device Names . . . . .                                      | 16       |

|           |   |      |
|-----------|---|------|
| <b>2.</b> | <b>Performing Disk Administration Procedures</b>              | . 19 |
|           | Listing the Disks on a System With <code>hinv</code>          | . 20 |
|           | Formatting and Initializing a Disk With <code>fx</code>       | . 21 |
|           | Adding Files to the Volume Header With <code>dvhtool</code>   | . 22 |
|           | Removing Files in the Volume Header With <code>dvhtool</code> | . 24 |
|           | Displaying a Disk's Partitions With <code>prtvtoc</code>      | . 26 |
|           | Repartitioning a Disk With <code>xdkm</code>                  | . 26 |
|           | Repartitioning a Disk With <code>fx</code>                    | . 27 |
|           | Before Repartitioning   | . 28 |
|           | Invoking <code>fx</code> From the Command Monitor             | . 28 |
|           | Invoking <code>fx</code> From IRIX                            | . 30 |
|           | Creating Standard Partition Layouts                           | . 31 |
|           | Creating Custom Partition Layouts                             | . 32 |
|           | After Repartitioning  | . 36 |
|           | Creating Mnemonic Names for Device Files With <code>ln</code> | . 36 |
|           | Creating a System Disk From the PROM Monitor                  | . 37 |
|           | Creating a New System Disk From IRIX                          | . 42 |
|           | Creating a New System Disk by Cloning                         | . 46 |
|           | Adding a New Option Disk                                      | . 49 |
| <b>3.</b> | <b>XLV Logical Volume Concepts</b>                            | . 51 |
|           | Introduction to XLV Logical Volumes                           | . 51 |
|           | Composition of XLV Logical Volumes                            | . 54 |
|           | Volumes   | . 56 |
|           | Subvolumes  | . 57 |
|           | Plexes  | . 59 |
|           | Volume Elements   | . 62 |
|           | Single-Partition Volume Elements                              | . 62 |
|           | Striped Volume Elements                                       | . 63 |
|           | Multipartition Volume Elements                                | . 64 |
|           | XLV Logical Volume Names                                      | . 65 |
|           | XLV Daemons   | . 65 |
|           | XLV Error Policy  | . 66 |



|  |           |
|--|-----------|
| XLV Logical Volume Planning . . . . .  | 66        |
| When to Avoid Using XLV . . . . .  | 66        |
| Selecting Subvolumes . . . . .   | 67        |
| Choosing Subvolume Sizes . . . . .   | 67        |
| Choosing Whether To Plex . . . . .   | 68        |
| Choosing Whether To Stripe . . . . .   | 68        |
| Choosing Whether to Concatenate Disk Partitions . . . . .  | 69        |
| <b>4. Creating and Administering XLV Logical Volumes . . . . .</b>                                   | <b>71</b> |
| Verifying That Plexing Is Supported . . . . .  | 72        |
| Creating Volume Objects With <code>xlvmake</code> . . . . .  | 72        |
| Example 1: Creating A Simple XLV Logical Volume . . . . .  | 73        |
| Example 2: Creating A Striped, Plexed XLV Logical Volume . . . . .                                   | 75        |
| Example 3: Creating A Plexed XLV Logical Volume for an XFS Filesystem With an External Log . . . . . | 76        |
| Displaying XLV Logical Volume Objects . . . . .  | 79        |
| Adding a Volume Element to a Plex (Growing an XLV Logical Volume) . . . . .                          | 80        |
| Adding a Plex to an XLV Logical Volume . . . . .   | 82        |
| Detaching a Plex From an XLV Logical Volume . . . . .  | 84        |
| Deleting an XLV Object . . . . .   | 85        |
| Removing and Mounting a Plex . . . . .   | 86        |
| Replacing a Disk For a Plexed Volume . . . . .   | 89        |
| Remove the Volume Element From XLV . . . . .   | 90        |
| Physically Replace the Disk Drive . . . . .  | 91        |
| Remake the XLV Volume Element Using the New Drive . . . . .  | 92        |
| Creating a Plexed XLV Logical Volume for Root . . . . .  | 92        |
| Booting the System Off an Alternate Plex . . . . .   | 95        |
| CHALLENGE L, CHALLENGE XL, and CHALLENGE DM . . . . .  | 95        |
| All Other Models . . . . .   | 96        |
| Configuring the System for More Than Ten XLV Logical Volumes . . . . .                               | 97        |
| Converting lv Logical Volumes to XLV Logical Volumes. . . . .  | 97        |
| Creating a Record of XLV Logical Volume Configurations . . . . .                                     | 99        |

|           |   |     |
|-----------|---|-----|
| <b>5.</b> | <b>Filesystem Concepts</b>  | 101 |
|           | IRIX Directory Organization                                       | 102 |
|           | General Filesystem Concepts                                       | 105 |
|           | Inodes  | 107 |
|           | Types of Files  | 108 |
|           | Hard Links and Symbolic Links                                     | 108 |
|           | Filesystem Names  | 110 |
|           | XFS Filesystems   | 110 |
|           | CXFS Filesystems  | 112 |
|           | EFS Filesystems   | 113 |
|           | Network File Systems (NFS)  | 113 |
|           | Cache File Systems (CacheFS)                                      | 114 |
|           | /proc Filesystem  | 114 |
|           | /hw Filesystem  | 115 |
|           | Foreign Filesystems   | 118 |
|           | XFS Filesystem Creation   | 118 |
|           | Filesystem Mounting and Unmounting                                | 119 |
|           | XFS Filesystem Checking   | 120 |
|           | Filesystem Reorganization   | 121 |
|           | Filesystem Administration From the Miniroot                       | 121 |
|           | How to Add Filesystem Space                                       | 121 |
|           | Mount a Filesystem as a Subdirectory                              | 122 |
|           | “Steal” Space From Another Filesystem                             | 122 |
|           | Grow an XFS Filesystem Onto Another Disk                          | 122 |
|           | Disk Quotas   | 123 |
|           | Filesystem Corruption   | 124 |
| <b>6.</b> | <b>Creating and Growing Filesystems</b>                           | 125 |
|           | Planning an XFS Filesystem  | 125 |
|           | Prerequisite Software   | 125 |
|           | Choosing the Filesystem Block Size and Extent Size                | 126 |
|           | Choosing the Filesystem Directory Format and Directory Block Size | 127 |

|  |             |
|--|-------------|
| Choosing the Log Type and Size . . . . .   | .128        |
| Choosing Allocation Groups and Stripe Units . . . . .                              | .130        |
| Disk Repartitioning . . . . .  | .131        |
| Making an XFS Filesystem . . . . .   | .132        |
| Making a Filesystem From inst . . . . .  | .137        |
| Making a Foreign Filesystem. . . . .   | .138        |
| Growing an XFS Filesystem Onto Another Disk . . . . .                              | .138        |
| Converting Filesystems on the System Disk From EFS to XFS . . . . .                | .140        |
| Converting a Filesystem on an Option Disk From EFS to XFS . . . . .                | .148        |
| Checking for Adequate Free Disk Space When Converting to XFS Filesystems . . . . . | .149        |
| Dump and Restore Requirements When Converting to XFS Filesystems . . . . .         | .151        |
| <b>7. Maintaining Filesystems. . . . .</b>   | <b>.153</b> |
| Routine Filesystem Administration Tasks . . . . .                                  | .153        |
| Mounting and Unmounting Filesystems . . . . .                                      | .154        |
| Manually Mounting Filesystems . . . . .  | .154        |
| Mounting Filesystems Automatically With the /etc/fstab File . . . . .              | .155        |
| Mounting a Remote Filesystem Automatically . . . . .                               | .157        |
| Unmounting Filesystems . . . . .   | .157        |
| Managing Disk Space . . . . .  | .158        |
| Monitoring Free Space and Free Inodes . . . . .                                    | .159        |
| Monitoring Key Files and Directories . . . . .                                     | .160        |
| Cleaning Out Temporary Directories . . . . .                                       | .161        |
| Locating Unused Files . . . . .  | .162        |
| Identifying Accounts That Use Large Amounts of Disk Space . . . . .                | .163        |
| Checking Disk Space Usage With du . . . . .  | .164        |
| Checking Disk Space Usage With find. . . . .                                       | .164        |
| Monitoring Disk Space Usage with Disk Quota Accounting . . . . .                   | .165        |
| Checking Disk Space Usage With quot . . . . .                                      | .166        |
| Checking Disk Space Usage on XFS Filesystems With quota . . . . .                  | .167        |
| Checking Disk Space Usage With diskusg . . . . .                                   | .167        |

|   |            |
|---|------------|
| Running Out of Space in the Root Filesystem . . . . .   | 168        |
| Using Disk Quotas on XFS Filesystems . . . . .  | 169        |
| Turning on Disk Quotas for Users on XFS Filesystems . . . . .   | 169        |
| Turning on Disk Quotas for Groups on XFS Filesystems. . . . .   | 170        |
| Turning on Disk Quotas for Projects on XFS Filesystems . . . . .                                      | 170        |
| Setting Disk Quota Limits for Users on XFS Filesystems. . . . .                                       | 171        |
| Setting Disk Quota Limits for Groups on XFS Filesystems . . . . .                                     | 172        |
| Setting Disk Quota Limits for Projects on XFS Filesystems . . . . .                                   | 172        |
| Displaying Disk Quota Information on XFS Filesystems. . . . .   | 173        |
| Administering Disk Quotas on XFS Filesystems . . . . .  | 175        |
| Copying XFS Filesystems With <code>xfs_copy</code> . . . . .  | 176        |
| Checking XFS Filesystem Consistency With <code>xfs_check</code> and <code>xfs_repair</code> . . . . . | 176        |
| Checking Filesystem Consistency . . . . .   | 177        |
| Repairing Inconsistent Filesystems . . . . .  | 178        |
| Checking Foreign Filesystem Consistency With <code>fpck</code> . . . . .                              | 180        |
| Repairing XFS Filesystem Problems . . . . .   | 180        |
| Common Error Messages . . . . .   | 180        |
| Error Messages When Files Are in <code>lost+found</code> . . . . .                                    | 182        |
| What to Do If <code>xfs_repair</code> Cannot Repair a Filesystem . . . . .                            | 183        |
| Mounting A Filesystem Without Log Recovery . . . . .  | 183        |
| Running <code>xfs_repair</code> on the Root Filesystem . . . . .                                      | 184        |
| <b>8. System Administration for Guaranteed-Rate I/O . . . . .</b>                                     | <b>185</b> |
| Guaranteed-Rate I/O Overview . . . . .  | 186        |
| GRIO Guarantee Types . . . . .  | 189        |
| Per-File and Per-Filesystem Guarantees . . . . .  | 189        |
| Private and Shared Guarantees . . . . .   | 189        |
| Rotor and Non-Rotor Guarantees . . . . .  | 189        |
| An Example Comparing Rotor and Non-Rotor Guarantees . . . . .   | 190        |
| Real-Time Scheduling, Deadline Scheduling, and Nonscheduled Reservations . . . . .                    | 191        |
| GRIO System Components . . . . .  | 192        |
| Hardware Configuration Requirements for GRIO . . . . .  | 193        |
| Configuring a System for GRIO . . . . .   | 193        |

|   |             |
|---|-------------|
| Additional Procedures for GRIO . . . . .                | .197        |
| Disabling Disk Error Recovery . . . . .                 | .197        |
| Restarting the ggd Daemon . . . . .                     | .200        |
| Running ggd as a Real-time Process . . . . .            | .200        |
| Using Real-Time Subvolumes . . . . .                    | .201        |
| Files on the Real-Time Subvolume and Commands . . . . . | .201        |
| File Creation on the Real-Time Subvolume . . . . .      | .202        |
| GRIO File Formats . . . . .                             | .202        |
| /etc/grio_disks File Format . . . . .                   | .202        |
| /etc/config/ggd.options File Format . . . . .           | .204        |
| <b>A. EFS Filesystems . . . . .</b>                     | <b>.205</b> |
| EFS Filesystem Overview . . . . .                       | .205        |
| EFS Filesystem Creation . . . . .                       | .207        |
| EFS Filesystem Creation Procedure . . . . .             | .207        |
| Growing an EFS Filesystem Onto Another Disk . . . . .   | .209        |
| EFS Filesystem Checking . . . . .                       | .210        |
| Checking Unmounted Filesystems . . . . .                | .211        |
| Checking Mounted Filesystems . . . . .                  | .212        |
| EFS Filesystem Reorganization . . . . .                 | .212        |
| EFS Filesystem Disk Space Management . . . . .          | .213        |
| Using Disk Quotas on EFS Filesystems . . . . .          | .213        |
| Imposing Disk Quotas on EFS Filesystems . . . . .       | .213        |
| Monitoring Disk Quotas on EFS Filesystems . . . . .     | .215        |
| Repairing EFS Filesystem Problems . . . . .             | .215        |
| General Errors . . . . .                                | .215        |
| Initialization Phase . . . . .                          | .216        |
| Phase 1 Check Blocks and Sizes . . . . .                | .217        |
| Phase 1 Error Messages . . . . .                        | .217        |
| Phase 1 Responses . . . . .                             | .219        |
| Phase 1B Rescan for More Bad Dups . . . . .             | .220        |

|   |            |
|---|------------|
| Phase 2 Check Pathnames . . . . .       | 220        |
| Phase 2 Error Messages . . . . .        | 220        |
| Phase 2 Responses . . . . .             | 222        |
| Phase 3 Check Connectivity . . . . .    | 222        |
| Phase 3 Error Messages . . . . .        | 222        |
| Phase 3 Responses . . . . .             | 223        |
| Phase 4 Check Reference Counts. . . . . | 224        |
| Phase 4 Error Messages . . . . .        | 224        |
| Phase 4 Responses . . . . .             | 226        |
| Phase 5 Check Free List . . . . .       | 227        |
| Phase 5 Error Messages . . . . .        | 227        |
| Phase 5 Responses . . . . .             | 228        |
| Phase 6 Salvage Free List . . . . .     | 228        |
| Cleanup Phase . . . . .                 | 228        |
| Cleanup Phase Messages. . . . .         | 228        |
| <b>Index. . . . .</b>                   | <b>231</b> |

---

# Figures

|                    |   |      |
|--------------------|---|------|
| <b>Figure 1-1</b>  | Controllers and Disk Drives . . . . .   | 2    |
| <b>Figure 1-2</b>  | Physical Disk Structure . . . . .   | 3    |
| <b>Figure 1-3</b>  | Disk Partitions . . . . .   | 5    |
| <b>Figure 1-4</b>  | Partition Layout of System Disks With Separate Root and Usr . . . . .                             | 7    |
| <b>Figure 1-5</b>  | Partition Layout of System Disks With Separate Root and Usr<br>and an XFS Log Partition . . . . . | 8    |
| <b>Figure 1-6</b>  | Partition Layout of System Disks With Combined Root and Usr . . . . .                             | 9    |
| <b>Figure 1-7</b>  | Partition Layout of Option Disks . . . . .  | 9    |
| <b>Figure 1-8</b>  | Partition Layouts of Options Disks With XLV Log Subvolumes . . . . .                              | 10   |
| <b>Figure 3-1</b>  | Writing Data to a Non-Striped Logical Volume. . . . .   | 53   |
| <b>Figure 3-2</b>  | Writing Data to a Logical Volume . . . . .  | 53   |
| <b>Figure 3-3</b>  | XLV Logical Volume Example . . . . .  | 55   |
| <b>Figure 3-4</b>  | Volume Composition . . . . .  | 57   |
| <b>Figure 3-5</b>  | Subvolume Composition . . . . .   | 58   |
| <b>Figure 3-6</b>  | Plexed Subvolume Example . . . . .  | 60   |
| <b>Figure 3-7</b>  | Plex Composition . . . . .  | 61   |
| <b>Figure 3-8</b>  | Single-Partition Volume Element Composition. . . . .  | 62   |
| <b>Figure 3-9</b>  | Striped Volume Element Composition . . . . .  | 63   |
| <b>Figure 3-10</b> | Multipartition Volume Element Composition . . . . .   | 64   |
| <b>Figure 5-1</b>  | The IRIX Filesystem . . . . .   | .106 |
| <b>Figure 5-2</b>  | Part of a Typical Hwgraph . . . . .   | .116 |
| <b>Figure 5-3</b>  | Mounting a Filesystem. . . . .  | .119 |





---

## Tables

|                  |  |      |
|------------------|--|------|
| <b>Table 1-1</b> | Standard Partition Numbers, Names, and Functions . . . . .   | 6    |
| <b>Table 1-2</b> | Partition Types and Uses . . . . .   | 11   |
| <b>Table 1-3</b> | Processor Types and sash Versions . . . . .  | 13   |
| <b>Table 1-4</b> | Device Name Construction . . . . .   | 17   |
| <b>Table 2-1</b> | sash and fx Versions . . . . .   | 29   |
| <b>Table 5-1</b> | Standard Directories and Their Contents . . . . .  | .102 |
| <b>Table 5-2</b> | Types of Files . . . . .   | .108 |
| <b>Table 6-1</b> | dump Arguments for Filesystem Backup . . . . .   | .143 |
| <b>Table 7-1</b> | Forms of the umount Command . . . . .  | .157 |
| <b>Table 7-2</b> | Files and Directories That Tend to Grow . . . . .  | .160 |
| <b>Table 8-1</b> | Examples of Values of Variables Used in Constructing an<br>XLV Logical Volume Used for GRIO. . . . . | .195 |
| <b>Table 8-2</b> | Disk Drive Parameters for GRIO . . . . .   | .197 |
| <b>Table 8-3</b> | Disks in /etc/grio_disks by Default . . . . .  | .203 |
| <b>Table 8-4</b> | Optimal I/O Sizes and the Number of Requests per Second<br>Supported . . . . .                       | .203 |
| <b>Table A-1</b> | Meaning of fsck Phase 1 Responses . . . . .  | .219 |
| <b>Table A-2</b> | Meaning of Phase 2 fsck Responses . . . . .  | .222 |
| <b>Table A-3</b> | Meaning of fsck Phase 3 Responses . . . . .  | .223 |
| <b>Table A-4</b> | Meaning of fsck Phase 4 Responses . . . . .  | .226 |
| <b>Table A-5</b> | Meanings of Phase 5 fsck Responses . . . . .   | .228 |



---

## Examples

|                    |   |      |
|--------------------|---|------|
| <b>Example 6-1</b> | mkfs Command for an XFS Filesystem Using Defaults . . . .                       | .133 |
| <b>Example 6-2</b> | mkfs Command for an XFS Filesystem With an Internal Log . . .                   | .134 |
| <b>Example 6-3</b> | mkfs Command for an XFS Filesystem With an External Log. . .                    | .135 |
| <b>Example 6-4</b> | mkfs Command for an XFS Filesystem With a Real-Time<br>Subvolume . . . . .      | .135 |
| <b>Example 6-5</b> | mkfs Command for an XFS Filesystem Specifying Directory<br>Block Size . . . . . | .136 |
| <b>Example 6-6</b> | mkfs Command for an XFS Filesystem with Version 1 Directory<br>Format . . . . . | .136 |
| <b>Example 8-1</b> | Configuration File for a Volume Used for GRIO . . . . .                         | .196 |



---

# IRIX Admin Manual Set



This guide is part of the *IRIX Admin* manual set, which is intended for administrators: those who are responsible for servers, multiple systems, and file structures outside the user's home directory and immediate working directories. If you maintain systems for others or if you require more information about IRIX than is in the end-user manuals, these guides are for you.

---

The *IRIX Admin* guides are available through the IRIS InSight online viewing system. The set consists of these volumes:

- *IRIX Admin: Software Installation and Licensing*—Explains how to install and license software that runs under IRIX, the Silicon Graphics implementation of the UNIX operating system. Contains instructions for performing miniroot and live installations using the `inst` command. Identifies the licensing products that control access to restricted applications running under IRIX and refers readers to licensing product documentation.
- *IRIX Admin: System Configuration and Operation*—Lists good general system administration practices and describes system administration tasks, including configuring the operating system; managing user accounts, user processes, and disk resources; interacting with the system while in the PROM monitor; and tuning system performance.
- *IRIX Admin: Disks and Filesystems* (this guide)—Explains disk, filesystem, and logical volume concepts. Provides system administration procedures for SCSI disks, XFS and EFS filesystems, XLV logical volumes, and guaranteed-rate I/O.
- *IRIX Admin: Networking and Mail*—Describes how to plan, set up, use, and maintain the networking and mail systems, including discussions of `sendmail`, UUCP, SLIP, and PPP.
- *IRIX Admin: Backup, Security, and Accounting*—Describes how to back up and restore files, how to protect your system's and network's security, and how to track system usage on a per-user basis.
- *IRIX Admin: Resource Administration*—Provides an introduction to system resource administration and describes how to use and administer various IRIX resource management features, such as IRIX process limits, IRIX job limits, the Miser Batch Processing System, the Cpuset System, and Comprehensive System Accounting (CSA), IRIX memory usage, and Array Services.
- *IRIX Admin: Peripheral Devices*—Describes how to set up and maintain the software for peripheral devices such as terminals, modems, printers, and CD-ROM and tape drives. Also includes specifications for the associated cables for these devices.
- *IRIX Admin: Selected Reference Pages* (not available in InSight)—Provides concise reference page (manual page) information on the use of commands that you may need while the system is down. Generally, each reference page covers one command, although some reference pages cover several closely related commands. Reference pages are available online through the `man(1)` command.

---

## About This Guide

*IRIX Admin: Disks and Filesystems* is one guide in the *IRIX Admin* series of IRIX system administration guides. It discusses important concepts and administration procedures for disks, filesystems, logical volumes, and guaranteed-rate I/O.

### What This Guide Contains

The types of disks, filesystems, and logical volumes covered in this guide are:

- SCSI disks. Systems that run IRIX 6.2 or later use only SCSI disks.
- The XFS filesystem. The XFS filesystem, a high-performance alternative to the earlier EFS filesystem developed by Silicon Graphics, was first released for IRIX 5.3.
- The Extent File System(EFS). The EFS filesystem, a filesystem developed by Silicon Graphics, was the filesystem used by IRIX for many years.
- XLV logical volumes. The XLV logical volume system, a high-performance logical volume system with many advanced features was developed by Silicon Graphics and released first for IRIX 5.3.

---

**Note:** This guide does not document administration of CXFS filesystems or XVM logical volumes. For information on CXFS filesystems, see the *CXFS Version 2 Software Installation and Administration Guide* and for information on XVM logical volumes see the *XVM Volume Manager Administrator's Guide*.

---

This guide is organized into chapters that provide reference information (the “concepts” chapters) and chapters that give procedures for performing disk and filesystem administration tasks. Appendices provide in-depth information about repairing inconsistent filesystems. These chapters and appendices are:

- Chapter 1, “Disk Concepts,” provides information about the structure of disks, disk partitioning, and disk partition device files.

- Chapter 2, “Performing Disk Administration Procedures,” describes disk administration tasks such as listing disks, initializing disks, modifying volume headers, repartitioning disks, creating device files, and adding new disks to systems.
- Chapter 3, “XLV Logical Volume Concepts,” describes the general concepts of logical volumes and the specifics of XLV logical volumes.
- Chapter 4, “Creating and Administering XLV Logical Volumes,” provides administration procedures for creating and administering XLV logical volumes and converting lv logical volumes (an older type of logical volume that is no longer supported) to XLV.
- Chapter 5, “Filesystem Concepts,” provides information about the IRIX filesystem layout, general filesystem concepts, details of the XFS filesystem types, and discussions of creating, mounting, checking, and growing filesystems.
- Chapter 6, “Creating and Growing Filesystems,” describes filesystem administration procedures such as making filesystems, mounting them, growing them, and converting from EFS to XFS.
- Chapter 7, “Maintaining Filesystems,” describes filesystem administration procedures that need to be performed routinely or on an as-needed basis, such as checking filesystems and managing disk usage when the amount of free disk space is low.
- Chapter 8, “System Administration for Guaranteed-Rate I/O,” provides information about guaranteed-rate I/O and the administration procedures required to support its use by applications.
- Appendix A, “EFS Filesystems”, provides information about EFS filesystems and their administration.

## Conventions Used in This Guide

These type conventions and symbols are used in this guide:

|                      |   |
|----------------------|---|
| <code>command</code> | This fixed-space font denotes literal items (such as commands, files, routines, pathnames, signals, messages, programming language structures, and e-mail addresses) and items that appear on the screen. |
| <i>variable</i>      | Italic typeface denotes variable entries and words or concepts being defined.   |



|                   |   |
|-------------------|---|
| <b>user input</b> | This bold, fixed-space font denotes literal items that the user enters in interactive sessions. Output is shown in nonbold, fixed-space font. |
| [ ]               | Brackets enclose optional portions of a command or directive line.  |
| ...               | Ellipses indicate that a preceding element can be repeated.   |
| manpage(x)        | Man page section identifiers appear in parentheses after man page names.  |

When a procedure provided in this guide can also be performed using the Disk Manager in the System Toolchest or additional information on a topic is provided in the *Personal System Administration Guide*, a Tip describes the information you can find in that document. For example:

---

**Tip:** You can use the Disk Manager in the System Toolchest to get information about the disks on a system. For instructions, see the “Checking Disk Setup Information” section in the *Personal System Administration Guide*.

---

When a procedure could result in the loss of files if not performed correctly or should be performed only by knowledgeable users, the procedure is preceded by a Caution. For example:

---

**Caution:** The procedure in this section can result in the loss of data if it is not performed properly. It is recommended only for experienced IRIX system administrators.

---

Some features described in this guide are available only when software option products are purchased. These features and their option products are identified in Notes. For example:

---

**Note:** The plexing feature of XLV, which enables the use of the optional plexes, is available only when you purchase the Disk Plexing Option software option.

---

## How to Use This Guide

*IRIX Admin: Disks and Filesystems* is written for system administrators and other knowledgeable IRIX users who need to perform administration tasks on their disks, filesystems, and logical volumes. It provides command line procedures for performing administration tasks; these tasks are most relevant to administering servers and workstations with many disks. Simple disk and filesystem administration using the graphical user interface provided by the Disk Manager is described in the *Personal System Administration Guide*.

Anyone with a basic knowledge of IRIX can use this guide to learn and perform basic disk and filesystem administration procedures. However, some procedures in this guide can result in loss of files on the system if the procedures are not performed correctly. These procedures should be performed by people who are:

- Familiar with IRIX filesystem administration procedures
- Experienced in disk repartitioning using `fx`
- Experienced in performing administration tasks from the shell in the miniroot environment provided by `inst`
- Familiar with filesystem backup concepts and procedures, particularly those using `dump`

A Caution paragraph appears at the beginning of each procedure that should be performed only by knowledgeable administrators. To learn more about system administration, see the *IRIX Admin: System Configuration and Operation* guide.

To use several features described in this guide, you must obtain FLEXlm licenses by purchasing separate software options. The features that require FLEXlm licenses are:

- The plexing feature of XLV logical volumes, which provides mirroring of disks up to four copies. This feature is provided by the Disk Plexing Option software option.
- Guaranteed-rate I/O. Guaranteed-rate I/O (GRIO) is a feature of IRIX that enables an application to request a fixed I/O rate and, if granted, be assured of receiving that rate. By default, the system allows four guaranteed-rate I/O streams. To obtain up to 40 streams, you must purchase the High Performance Guaranteed-Rate I/O—5-40 Streams software option. An unlimited number of streams is provided by the High Performance Guaranteed-Rate I/O—Unlimited Streams software option.

## Product Support

Silicon Graphics offers comprehensive product support and maintenance programs for its products. For information about using support services for IRIX and the other products described in this guide, refer to the release notes for IRIX and `oe`.

## Additional Resources

For more information about disk management on IRIX, see these sources:

- The *Personal System Administration Guide* provides basic information on system administration of Silicon Graphics systems. Although it has not yet been updated to include information on XFS and XLV, it provides basic information on many system administration tasks.
- Online reference pages (man pages) on various disk information and management commands are included in the standard system software and can be viewed online using the `man` and `xman` commands or the Man Pages item on the Help menu of the System Toolchest.
- The *CXFS Version 2 Software Installation and Administration Guide* describes the administration of CXFS filesystems.
- The *XVM Volume Manager Administrator's Guide* describes the configuration and administration of XVM logical volumes using the XVM Volume Manager.

For more information on developing applications that access XFS filesystems, see these sources:

- Online reference pages for system calls and library routines relevant to XFS and GRIO are provided in the IRIS Developer's Option (IDO) software product.
- The *REACT/Pro Programmer's Guide* provides information about developing applications that use GRIO.

For instructions on loading the miniroot, see *IRIX Admin: Software Installation and Licensing*.

For information on acquiring and installing FLEXlm licenses that enable the Disk Plexing and High Performance Guaranteed-Rate I/O software options, see *IRIX Admin: Software Installation and Licensing*.

For additional information on changes in recent software releases of the software documented in this guide, see the release notes for these products:

- IRIX
- eoe
- NFS
- dev

## Reader Comments

If you have comments about the technical accuracy, content, or organization of this document, please tell us. Be sure to include the title and part number of the document with your comments. (Online, the document number is located in the front matter of the manual. In printed manuals, the document number can be found on the back cover.)

You can contact us in any of the following ways:

- Send e-mail to the following address:  
`techpubs@sgi.com`
- Use the Feedback option on the Technical Publications Library Web page:  
`http://docs.sgi.com`
- Contact your customer service representative and ask that an incident be filed in the SGI incident tracking system.
- Send mail to the following address:  
Technical Publications  
SGI  
1600 Amphitheatre Pkwy.  
Mountain View, California, 94043-1351
- Send a fax to the attention of “Technical Publications” at:  
+1 650 932 0801

We value your comments and will respond to them promptly.

## Disk Concepts

This chapter provides background information that helps you successfully set up the disks and disk device files on your system.

The major sections in this chapter are:

- “Disk Drives on Silicon Graphics Systems” on page 2
- “Physical Disk Structure” on page 3
- “Disk Partitions” on page 4
- “System Disks, Option Disks, and Partition Layouts” on page 6
- “Partition Types” on page 11
- “Volume Headers” on page 12
- “Device Files” on page 14

If you are installing a disk drive, see the installation instructions furnished with the hardware. Disk administration procedures are described in Chapter 2, “Performing Disk Administration Procedures.” For information on XLV logical volumes and filesystems, begin with Chapter 3, “XLV Logical Volume Concepts.”

---

**Note:** For information on disk layout and disk partitioning with the XVM Volume Manager, see the *XVM Volume Manager Administrator’s Guide*.

---

## Disk Drives on Silicon Graphics Systems

Figure 1-1 shows how disk drives and other peripheral devices are connected to controllers in systems.

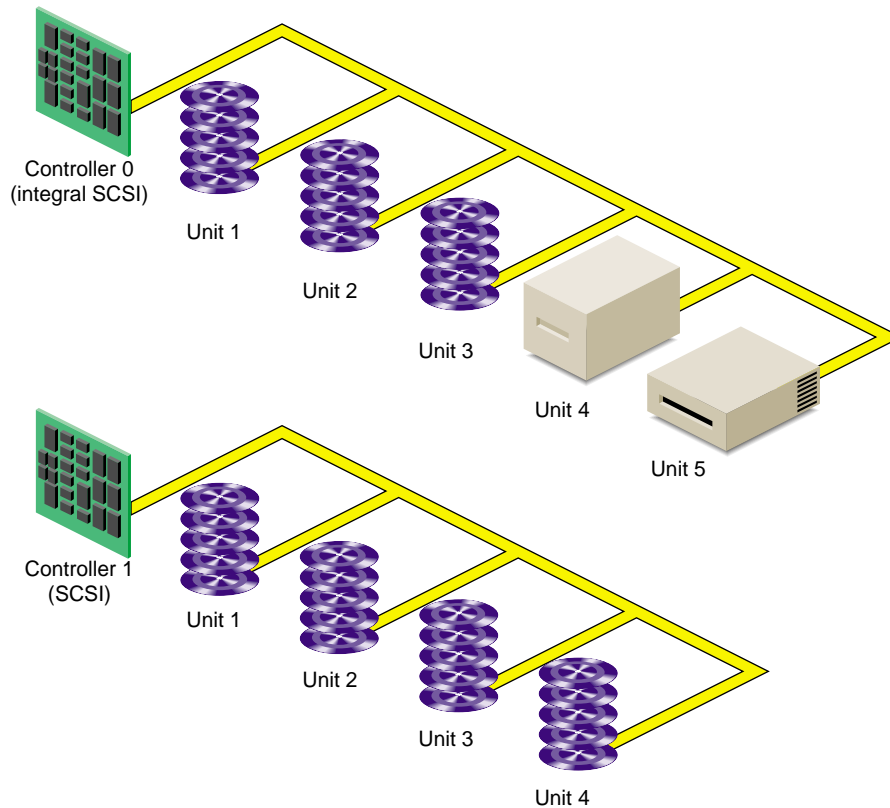

**Figure 1-1** Controllers and Disk Drives

Each disk drive is managed by a controller. Each type of controller can support a fixed number of drives. Your workstation can support a fixed number of controllers. (For the number and type of controllers supported by your model of workstation, see your hardware owner's guide.) SCSI controllers support up to seven disks per controller or up to 15 disks per controller (depending upon the SCSI controller type), and VME controllers support up to 14 disks per controller.

Each disk is assigned a drive address (called the unit number in output from the `hinv` command and also known as a SCSI ID). This address is set by a switch, a dial, or jumpers on the disk, or by the physical location of the disk. See the hardware owner's guide for the system for information on setting the drive address of a disk.

Some SCSI devices, such as RAIDs (an array of disks with built-in redundancy), have an additional identifying number called a logical unit number or *lun*. It is used to address disks within the device.

## Physical Disk Structure

Figure 1-2 shows the physical structure of a disk. A disk consists of circular plates called *platters*. Each platter has an upper and lower oxide-coated *surface*. Recording *heads*, at least one per surface, are mounted on arms that can be moved to various radial distances from the center of the platters. The heads float very close to the surfaces of the platters, never actually touching them, and read and record data as the platters spin around.

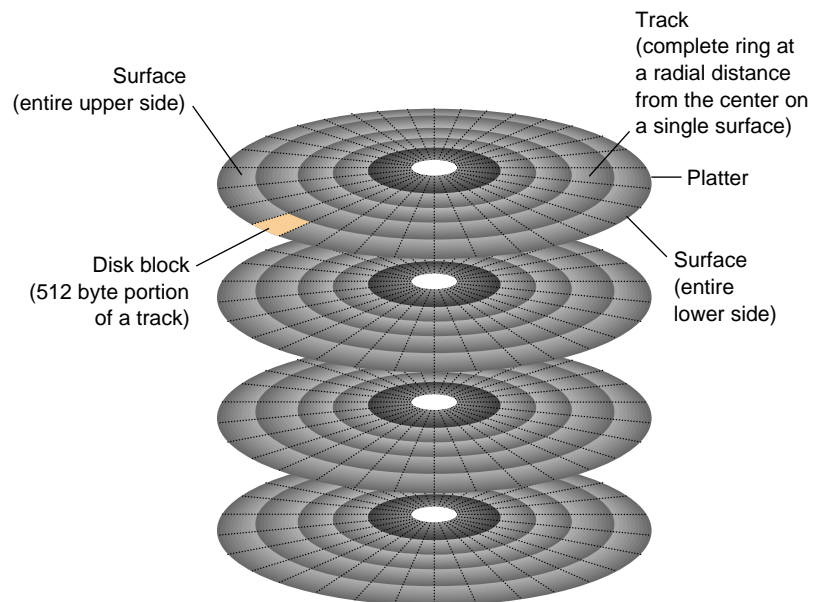

**Figure 1-2** Physical Disk Structure

As shown in Figure 1-2, a ring on one surface is called a *track*. Each track is divided into *disk blocks*. Sometimes called *sectors*, these physical blocks on a disk are different from filesystem blocks.

Formatting a disk divides the disk into tracks and disk blocks that can be addressed by the disk controller, writes timing marks, and identifies bad areas on the disk (called *bad blocks*). SCSI disk drives are shipped preformatted. They do not require formatting at any time. Bad block handling is performed automatically by SCSI disks. Bad blocks are areas of a disk that cannot reliably store data. Bad block handling maps bad blocks to substitute blocks that are in a reserved area of disk that is inaccessible by normal IRIX commands.

## Disk Partitions

Disks are divided into logical units called *partitions*. Figure 1-3 shows an example of a partitioned disk. Partitions divide the disk into fixed-size portions that can be used by IRIX or by users for different purposes. Partition sizes are measured in 512-byte disk blocks. On SCSI disks, partitions only need to be integral numbers of disk blocks.



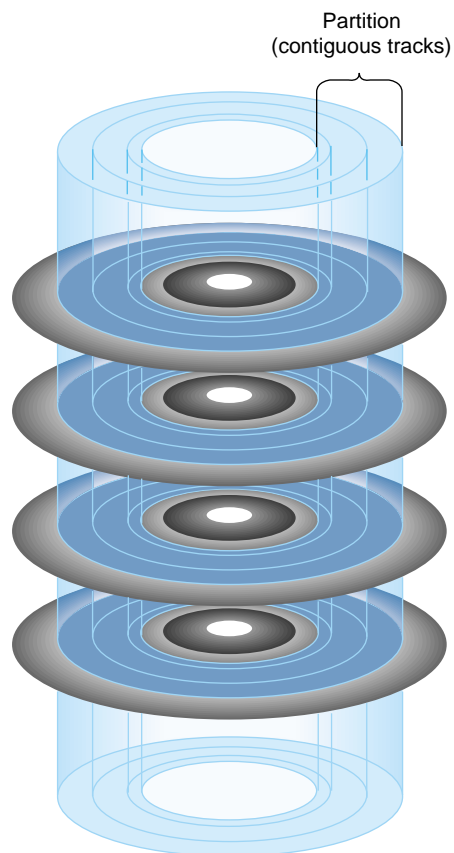

**Figure 1-3** Disk Partitions

Each disk block can belong to any number of partitions, including no partition (in which case the disk space is unused or wasted). This means that partitions can overlap. For example, a disk can be divided into several non-overlapping partitions and have an additional partition defined that is the entire disk.

Each partition on a disk has a number from 0 through 15. By convention, some of these partition numbers have a particular function and a name. Table 1-1 shows these numbers, names, and functions .

**Table 1-1** Standard Partition Numbers, Names, and Functions

| Partition Number | Name   | Function  |
|------------------|--------|---|
| 0                | root   | Root partition, used for the root filesystem on system disks.   |
| 1                | swap   | Swap partition, used by IRIX for temporary storage when there is less physical memory than all of its processes need. |
| 6                | usr    | usr partition, used on system disks when separate root and usr filesystems are used.                                  |
| 7                | (none) | The entire disk except the volume header and xfslog partition (if present).   |
| 8                | volhdr | Volume header (see the section “Volume Headers” on page 12).  |
| 9                | (none) | Reserved partition (historically, this partition was the bad block partition on non-SCSI drives).                     |
| 10               | volume | The entire disk, including the volume header.   |
| 15               | xfslog | A small partition used for an XFS log (see “Partition Types” on page 11).   |

## System Disks, Option Disks, and Partition Layouts

*System disks* contain the IRIX operating system. Specifically, they must contain a volume header that includes *sash* (see “Volume Headers” on page 12), the root filesystem, a swap partition, and possibly a *usr* filesystem. Each workstation or server has one system disk; IRIX is booted from this disk when the system is brought up. On workstations, the system disk is on controller number 0 and drive address 1 by default. On some servers, the default controller and drive address for the system disk is controller 1 and drive address 1. The location of the system disk is reported by the *nvrAm* command; it is the value of *OSLoadPartition*.

All disks on the system other than the system disk are known as *option disks*. Disks are shipped from Silicon Graphics with one of several standard partition layouts which are

described and illustrated in this section. You can list the partitions of a disk with the `prtvtoc` command (see the “Displaying a Disk’s Partitions With `prtvtoc`” in Chapter 2).

---

**Note:** When you use the XVM Volume Manager to create XVM logical volumes on a disk, you first label the disk as an XVM disk. The XVM Volume Manager then controls the partitioning on that disk. For information on partition layout under XVM, see the *XVM Volume Manager Administrator’s Guide*.

---

Figure 1-4 and Figure 1-5 show the two common layouts of a system disk with separate partitions for the root and `usr` filesystems. The layout in Figure 1-4 is used for EFS filesystems and for XFS filesystems when the XFS log does not have its own partition (it is an *internal* XFS log). Figure 1-5 shows the partition layout when an XFS log partition is included (an *external* log).

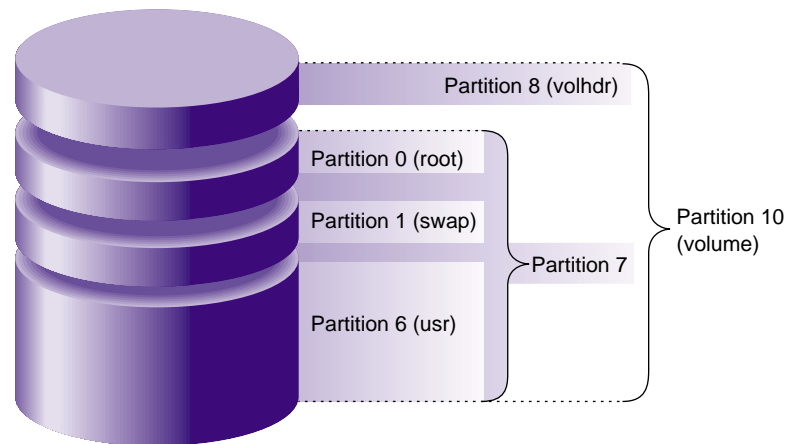

**Figure 1-4** Partition Layout of System Disks With Separate Root and Usr

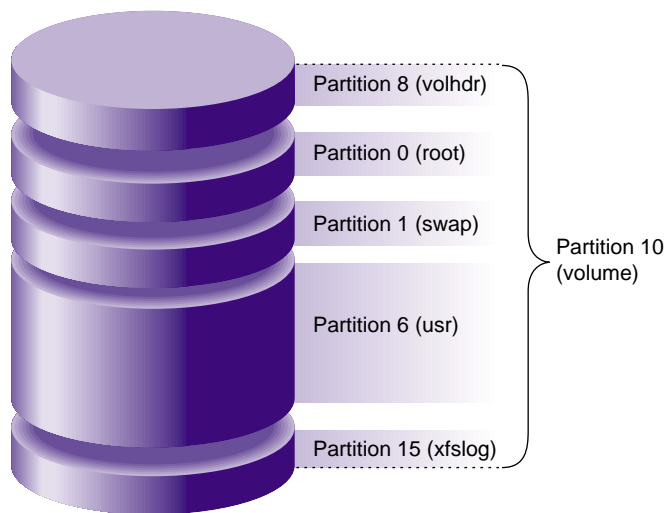

**Figure 1-5** Partition Layout of System Disks With Separate Root and Usr and an XFS Log Partition

Separate root and `usr` partitions were standard on older systems and are still used on servers. In the original UNIX design, only the root filesystem needed to be mounted to boot UNIX. This is not true for IRIX anymore—both filesystems must be mounted, so there is no longer the concept of the root filesystem being a minimal subset of operating system software.

Figure 1-6 shows the layout of a system disk with a single partition for a combined root and `usr` filesystem and a swap partition. This arrangement is standard on most newer systems. However, restrictions on making the root partition part of an XLV logical volume may make separate root and `usr` partitions a better choice than a single combined partition (see Chapter 3, “XLV Logical Volume Concepts,” for information about XLV logical volume restrictions).

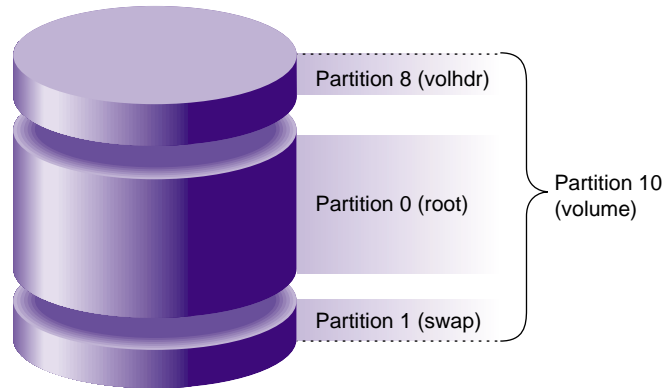

**Figure 1-6** Partition Layout of System Disks With Combined Root and User

Figure 1-7 shows the standard layout of an option disk that does not have an XFS log partition. It has a single partition for data.

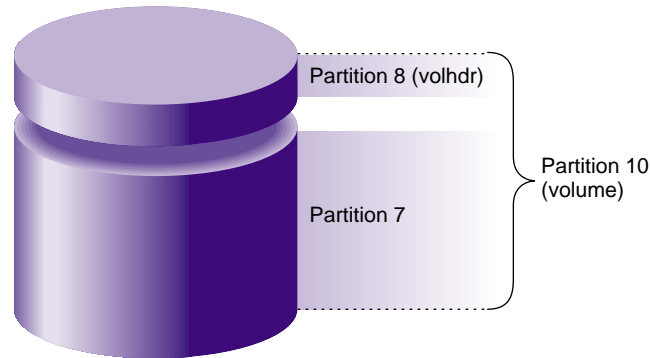

**Figure 1-7** Partition Layout of Option Disks

Figure 1-8 shows the layout of an option disk with two partitions, one for data and one for an XFS log.

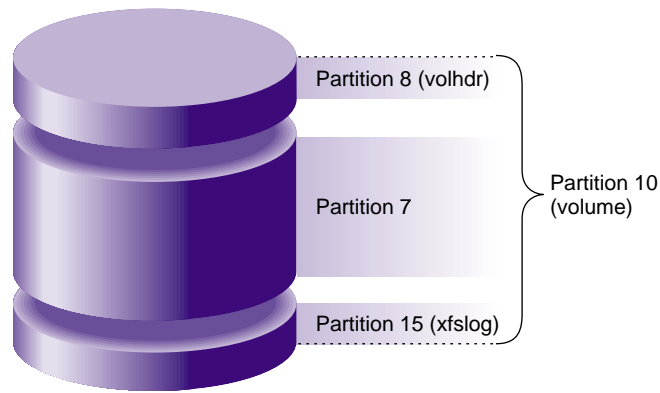

**Figure 1-8** Partition Layouts of Options Disks With XLV Log Subvolumes

The default partition layouts are generic in nature and should be evaluated by the system administrator. After your system has been in operation for a few months, you may decide that a different arrangement would better serve your users' needs. Consider the following points in choosing partition layouts:

- A single file can not be larger than its filesystem.
- When disks are partitioned into several filesystems, a runaway process that writes a file fills just a partition rather than the entire disk.
- A large root partition ensures that you can install future, and most likely larger, IRIX system software releases without running out of disk space in the root filesystem.

Use the `fx` command to change disk partitions (called *repartitioning* a disk). The command can be used with standard partition layouts or to create custom partition layouts. For additional information on using `fx` to repartition disks, see "Repartitioning a Disk With `fx`" in Chapter 2.

Once you partition disks, you can use these partitions as filesystems, as parts of an XLV logical volume, or as raw disk space. XLV logical volumes are described in Chapter 3, "XLV Logical Volume Concepts." Filesystems are described in Chapter 5, "Filesystem Concepts."

## Partition Types

Each partition has a type that is displayed by `fx` and `prtvtoc`. Table 1-2 lists the partition types, their uses, and the partition numbers that can be assigned to those types. (Partition 9 isn't listed in this table; remember that it is reserved.) Partition types, except for `xlv`, are assigned by `fx`. The type `xlv` is automatically assigned by several XLV logical volume commands.

**Table 1-2** Partition Types and Uses

| Partition Type      | Partition Use   | Partitions That Can Be This Type   |
|---------------------|---|--|
| <code>efs</code>    | EFS filesystem  | 0, 6, 7 (standard partitions);<br>2, 3, 4, 5, 11, 12, 13, 14, 15 (custom partitions)   |
| <code>xfs</code>    | XFS filesystem  | 0, 6, 7 (standard partitions);<br>2, 3, 4, 5, 11, 12, 13, 14, 15 (custom partitions)   |
| <code>xfslog</code> | External log for an XFS filesystem (part of an XLV log subvolume) | 15 (standard partition);<br>0, 2, 3, 4, 5, 6, 7, 11, 12, 13, 14 (custom partitions)  |
| <code>raw</code>    | Swap space  | 1  |
| <code>volhdr</code> | Volume header   | 8  |
| <code>volume</code> | Entire volume, including the volume header                        | 10   |
| <code>xlv</code>    | Part of an XLV data or real-time subvolume                        | 0, 1, 2, 3, 4, 5, 6, 7, 11, 12, 13, 14, 15 (partitions are changed to type <code>xlv</code> by XLV commands)   |
| <code>lvpl</code>   | Part of an <code>lv</code> logical volume                         | This partition type is now obsolete. <code>lv</code> logical volumes must be converted to XLV logical volumes. See "Converting <code>lv</code> Logical Volumes to XLV Logical Volumes" in Chapter 4. |

The partitions listed as standard partitions in Table 1-2 are created when you use the `fx` repartition functions `rootdrive`, `usrrootdrive`, and `optiondrive`. Prompts ask you whether you want partition type `efs` or `xfs`. If you specify `xfs` for `usrrootdrive` or `optiondrive`, prompts ask whether you want an `xfslog` partition. To use an `xfslog` partition (an *external* XFS log), you must configure the `xfslog` partition as an XLV log subvolume. (See Chapter 4, "Creating and Administering XLV Logical

Volumes,” for more information about XLV.) If you do not use an `xfslog` partition, the XFS log is stored in an `xfs` partition (and called an *internal* log).

To assign a partition type to a partition number listed as a custom partition in Table 1-2, you must use the expert mode of `fx` (`fx -x`) to create the partition and assign the type. (See the `fx(1M)` reference page for more information about the expert mode of `fx`.)

## Volume Headers

A partition called the *volume header* is stored on the partition that begins at disk block 0. (For proper system operation, the volume header must begin at disk block 0). It contains a minimal filesystem with a few files that contain information about the device parameters, the partition layout, the version number of the most recently used version of `fx`, and logical volume information. It also may contain some standalone programs.

The files and standalone programs that may be in a volume header are:

|                       |  |
|-----------------------|--|
| <code>sgilabel</code> | This file contains <code>fx</code> version number information. It is important not to delete this file from the volume header.   |
| <code>symmon</code>   | <code>symmon</code> is a standalone program used to debug the kernel. See the <code>symmon(1M)</code> reference page for more information.   |
| <code>xlvlab*</code>  | XLV logical volume information is stored in files called <i>logical volume labels</i> in the volume header. XLV logical volume information is stored in files whose names begin with <code>xlvlab</code> . This information is used by the system to assemble XLV logical volumes when the system is booted. XLV logical volume labels are created automatically when XLV logical volumes are created. |
| <code>lvlab*</code>   | Logical volume labels for <code>lv</code> logical volumes were stored in files whose names began with <code>lvlab</code> . <code>lv</code> logical volumes are no longer supported.  |
| <code>ide</code>      | <code>ide</code> (integrated diagnostics environment) is a diagnostics program for low-end systems only. <code>ide</code> is executed when you choose the third item, “Run Diagnostics,” on the System Maintenance Menu. Newer systems execute <code>ide</code> from the <code>/stand</code> directory if it is not in the volume header.  |
| <code>fx</code>       | <code>fx</code> is the standalone version of the IRIX <code>fx</code> command. It is a disk utility used primarily for repartitioning disks. Older systems sometimes included a copy of the command <code>fx</code> in the volume header. There is no longer any need for <code>fx</code> in the volume header.  |



`sash` On system disks, a copy of the standalone program `sash` (the standalone shell) must be in the volume header; it is required to boot a system. `sash` is a processor-specific program. Therefore, if you ever need to copy it from the `/stand` directory of another system or from the `/stand` directory of a software distribution CD, you must copy the correct version. If you copy from another system, both systems must have the same processor type. If you copy it from a software distribution CD, use the `hinv` command to identify the processor type of your system and Table 1-3 to identify the version of `sash` needed for that system.

**Table 1-3** Processor Types and `sash` Versions

| Processor Type         | <code>sash</code> Version |
|------------------------|---------------------------|
| IP17                   | <code>sashIP17</code>     |
| IP19, IP20, IP22       | <code>sashARCS</code>     |
| IP21, IP25, IP26, IP27 | <code>sash64</code>       |

The `fx` command can be used to display and modify the device parameters and the partition layout. See the `fx(1M)` reference page and the section “Repartitioning a Disk With `fx`” in Chapter 2. Using `fx` has the side effect of creating the file `sgilabel` in the volume header.

The command `prtvtoc` is also used to display partition layout information. See “Displaying a Disk’s Partitions With `prtvtoc`” in Chapter 2 for instructions.

The `dvhtool` command can be used to add and delete standalone programs from the volume header. `dvhtool` can also be used to delete XLV logical volume labels from the volume header. See “Adding Files to the Volume Header With `dvhtool`,” and “Removing Files in the Volume Header With `dvhtool`” in Chapter 2 for more information.

The volume header is consulted (and therefore any mistakes made creating or modifying the volume header become apparent) only at these times:

- During the boot up process
- When creating or growing filesystems
- When creating or growing logical volumes
- When adding swap areas

## Device Files

IRIX programs communicate with hardware devices through two types of files, called *special files*. The two types are *character device files* (also called *raw device files*) and *block device files*. Conceptually, a disk device is treated as if it were a file. In practice, there are differences between regular files and device files, so the latter are referred to as *special files*.

Drivers that have been written to be hardware graph aware produce real device nodes in `/hw` which are not modifiable by any user-level command. These have links back into the familiar `/dev` device nodes to provide the standard pathnames used by most programs and administrators. Disk devices are among these hardware graph aware drivers. Drivers that are not hardware graph aware still exclusively use `/dev`.

---

**Note:** The `/dev` directory is the root of the recommended path for all device file usage, even though many of the files and directories under `/dev` are links to `/hw`. Do not use device names under `/hw` when mounting filesystems or configuring the root filesystem. For more information about the `/hw` filesystem, see “`/hw` Filesystem” in Chapter 5.

---

Device files are created automatically when system software is installed, when disk drives are repartitioned, and, if necessary, at system boot up. In unusual cases where device files are not automatically created, as in the case of pseudo-devices, the `MAKEDEV` or `mknod` commands can be used. See the `MAKEDEV(1M)` and `mknod(1M)` reference pages for more information.

The following examples of output are the results of the `ls -l` command invoked on a user's regular file and on a disk device in the `/hw` filesystem. They show the difference in structure between regular and device files. This is a regular file:

```
-rw-r----- 1 ralph raccoons 1050 Apr 23 08:14 scheme.notes
```

Regular files are indicated by a dash (-) in the first column. The remainder of the output is explained in the guide *IRIX Admin: System Configuration and Operation*.

These are device files for the block and character devices for a root disk partition:

```
brw----- 0 root sys 0, 79 Oct 14 11:15  
/hw/node/io/gio/hpc/scsi_ctlr/0/target/1/lun/0/disk/partition/0/block  
crw----- 0 root sys 0, 80 Oct 14 11:14  
/hw/node/io/gio/hpc/scsi_ctlr/0/target/1/lun/0/disk/partition/0/char
```

The links in the `/dev` directory to these device files are:

```
lrw----- 0 root    sys          70 Oct 14 11:12 /dev/dsk/dks0d1s0 ->
/hw/node/io/gio/hpc/scsi_ctlr/0/target/1/lun/0/disk/partition/0/block
lrw----- 0 root    sys          69 Oct 14 11:13 /dev/rdisk/dks0d1s0 ->
/hw/node/io/gio/hpc/scsi_ctlr/0/target/1/lun/0/disk/partition/0/char
```

The device file listing is similar to the listing of the regular file, but contains additional information. The device files shown have the following characteristics:

- The first column of the listing contains a `b` or a `c` to indicate the type of device: *block* or *character*.
- In the field of a long listing where a regular file shows the byte count of the file, a device file displays two numerals called the *major* and *minor device numbers*.
- The filenames are device names, which are constructed based on hardware type and configuration.

The following sections explain these characteristics of device files.

## Block and Character Devices

Block device files (also called block devices) and character device files (also called character devices or raw devices) differ in the way in which they are accessed.

Block devices access data in blocks that come from a system buffer cache. Only blocks of data of a certain size are read from a block device.

Character devices access data on a character-by-character basis. Programs such as terminal and pseudo-terminal device drivers that do their own input and output buffering use character devices. Some types of hardware, such as disks and tapes, can have both character and block device files. The difference is that the character interface for disks bypasses the buffer cache.

The section “Device Names” on page 16 explains the naming conventions for block and character device files.

## Device Permissions and Owner

The files are owned by `root` with group `sys`, and no other user or group has permission to use them. This means that only processes with the `root` ID can read from and write to the device files. Tape devices, floppy drives, and `tty` terminals are some common exceptions to this rule.

## Major and Minor Devices

Major and minor device numbers appear where the character count appears in the listing of a normal file.

The major device number refers to a specific device driver. The minor device number specifies a particular physical unit and possibly characteristics of the unit. For disks, the minor number identifies the drive address and the partition. The major and minor device numbers are displayed by the `ls -l` command.

Some devices have identical major and minor number pairs, but they are designated in one entry as a block device (a `b` in the first column) and in another entry as a character device (a `c` in the first column). Notice that such pairs of files have different filenames or are in different directories (for example, `/dev/dsk/dks0d1s0` and `/dev/rdisk/dks0d1s0`).

## Device Names

Device names for disks are filenames that indicate the type of hardware (disk), type of device access (block or character), type of device, controller number, drive address, and partition number. For example, the block device name for the root partition of an SCSI

system disk is `/dev/dsk/dks0d1s0`. Table 1-4 lists each component of this filename, describes its meaning, and lists other possible values.

**Table 1-4** Device Name Construction

| Device Name Component | Purpose  | Possible Values  |
|-----------------------|--|--|
| <code>dev</code>      | Device files directory   | <code>dev</code>   |
| <code>dsk</code>      | Subdirectory for hard disk files (think “disk” to remember it) | <code>dsk</code> (block device files)<br><code>rdsk</code> (character device files; the <code>r</code> stands for “raw,” another name for the character device)  |
| <code>dks</code>      | Disk device type   | <code>dks</code> (SCSI device)<br><code>fd</code> (floppy disk)<br><code>raid</code> (SCSI RAID device)  |
| <code>0</code>        | Controller number  | <code>0–n</code> , where <code>n</code> is system dependent (SCSI)<br>(SCSI RAID)  |
| <code>d1</code>       | Drive address  | <code>d1–d7</code> or <code>d1–d15</code> (SCSI, depends on controller type)<br><code>d<math>n</math></code> where <code>n</code> is in the range 0–147 and doesn’t end in 8 or 9 (SCSI RAID)  |
| <code>s0</code>       | Partition number (slice number)                                | <code>s0</code> (root, for the root filesystem)<br><code>s1</code> (swap)<br><code>s2</code><br><code>s3</code><br><code>s4</code><br><code>s5</code><br><code>s6</code> ( <code>usr</code> , for the <code>usr</code> filesystem)<br><code>s7</code> (entire usable portion of disk, excludes the volume header)<br><code>s8, vh</code> (volume header)<br><code>s9</code> (non-SCSI bad block list)<br><code>s10, vol</code> (entire disk)<br><code>s11</code><br><code>s12</code><br><code>s13</code><br><code>s14</code><br><code>s15</code> (XFS log) |

Some examples of device names and their meanings are:

`/dev/dsk/dks0d1s0`

The block device file for partition (slice) 0 of the SCSI disk on controller 0 at drive address 1.

`/dev/dsk/jag5d13s7`

The block device file for partition 7 (the entire disk except volume header) of the Jaguar disk on controller 5 at drive address 13.

`/dev/rdisk/dks0d2vh`

The character (raw) device for the volume header (partition 8) of the SCSI disk on controller 0 at drive address 2.

Device file names for disks are symbolic links into the system hardware graph. For more information about this IRIX feature that describes the hardware entities on a system and their relationships, see “/hw Filesystem” in Chapter 5.

## Performing Disk Administration Procedures

This chapter describes administration procedures for disks and their device files.

The major sections in this chapter are:

- “Listing the Disks on a System With `hinv`” on page 20
- “Formatting and Initializing a Disk With `fx`” on page 21
- “Adding Files to the Volume Header With `dvhtool`” on page 22
- “Removing Files in the Volume Header With `dvhtool`” on page 24
- “Displaying a Disk’s Partitions With `prtvtoc`” on page 26
- “Repartitioning a Disk With `xdkm`” on page 26
- “Repartitioning a Disk With `fx`” on page 27
- “Creating Mnemonic Names for Device Files With `ln`” on page 36
- “Creating a System Disk From the PROM Monitor” on page 37
- “Creating a New System Disk From IRIX” on page 42
- “Creating a New System Disk by Cloning” on page 46
- “Adding a New Option Disk” on page 49

Administration procedures for filesystems and XLV logical volumes are described in later chapters of this guide.

## Listing the Disks on a System With `hinv`

You can list the disks connected to a system by issuing this `hinv` command from IRIX:

```
# hinv -c disk
```

The output lists the disk controllers and disks present on a system, for example:

```
Integral SCSI controller 0: Version WD33C93B, revision D
  Disk drive: unit 2 on SCSI controller 0
  Disk drive: unit 1 on SCSI controller 0
```

This output shows a single integral SCSI controller whose number is 0 and two disk drives. These disks are at drive addresses 1 and 2. In `hinv` output, drive addresses are called units. They are also sometimes called unit numbers. Each disk is uniquely identified by the combination of its controller number and drive address.

If you are in the PROM Monitor, you can also give the `hinv` command from the **Command Monitor**:

```
>> hinv
```

Output for SCSI disks looks like this:

```
SCSI Disk: scsi(0)disk(1)
SCSI Disk: scsi(0)disk(2)
```

In this output, the controller number is the “scsi” number and the drive address is the “disk” number. The type of controller is not listed. As a rule, workstations have integral controllers and servers may have integral SCSI controllers or non-integral controllers that are SCSI or VME. On some Challenge systems, the output of `hinv` in the PROM monitor shows only disks on the boot IOP (I/O processor).



The controller number and drive addresses of disks are specified, using a variety of syntax, as arguments to the IRIX disk and filesystem commands, such as `fx`, `prtvtoc`, `dvhtool`, and `mkfs`. For example, for a disk on controller 0 at drive address 1:

- To specify the disk on an `fx` command line, the command line is:  

```
# fx "dks0c(0,1)"
```
- To specify the disk (actually, its volume header) on a `prtvtoc` command line, either of these two commands can be used:  

```
# prtvtoc /dev/rdisk/dks0d1vh  
# prtvtoc dks0d1vh
```
- To specify the disk 1 (actually, its volume header) on a `dvhtool` command line, the command is:  

```
# dvhtool /dev/rdisk/dks0d1vh
```
- To specify partition 7 of the second disk above on a `mkfs` command line for an XFS filesystem, the command is:  

```
# mkfs /dev/rdisk/dks0d1s7
```

---

**Tip:** You can use the Disk Manager in the System Toolchest to get information about the disks on a system. For instructions, see the section “Disk Manager” in Chapter 3 of the *Personal System Administration Guide*.

---

## Formatting and Initializing a Disk With `fx`

When you format a disk, you write timing marks and divide the disk into tracks and sectors that can be addressed by the disk controller. SCSI disks are shipped preformatted; formatting a SCSI disk is rarely required. Formatting is done by `fx`; see the `fx(1M)` reference page for details.

---

**Caution:** Formatting a disk results in the loss of all data on the disk. It is recommended only for experienced IRIX system administrators.

---

Formatting a disk destroys information about bad areas on the disk (called *bad blocks*). Identifying and handling bad blocks is also done by `fx`; see the `fx(1M)` reference page for details.

---

**Caution:** Using `fx` for bad block handling usually results in the loss of all data on the block. It is recommended only for experienced IRIX system administrators.

---

Initializing a disk consists of creating a volume header for a disk. Disks supplied by Silicon Graphics are shipped with a volume header, so initialization is not necessary. Disks from third-party vendors or disks whose volume headers have been destroyed must be initialized to create a volume header. Initializing disks is done by `fx`. No explicit commands are necessary; `fx` automatically detects if no volume header is present and creates one. (See “Repartitioning a Disk With `fx`” on page 27 for information on invoking `fx`.) When `fx` creates a volume header, a prompt asks if you want to write the volume header; reply yes.

---

**Tip:** You can use the Disk Information window of the Disk Manager in the System Toolchest to perform disk initialization and other tasks. For more information, see the section “Managing Disk Drives” in Chapter 3 of the *Personal System Administration Guide*.

---

## Adding Files to the Volume Header With `dvhtool`

As explained in “Volume Headers” in Chapter 1, the volume header of system disks must contain a copy of the program `sash`. The procedure in this section explains how to put `sash` or other programs into a volume header. Before performing this procedure, review the discussion of `dvhtool` in “Volume Headers” in Chapter 1.

When you add programs to the volume header of a disk, there are two sources for those programs. One is the `/stand` directory of the system and the other is the `/stand` directory on an IRIX software release CD. The `/stand` directory on a CD (usually `/CDROM/stand` after the CD is mounted) contains copies of `sash`, `fx`, and `ide` that are processor-specific.

As superuser, perform this procedure to add programs to a volume header:

1. Invoke `dvhtool` with the raw device name of the volume header of the disk as an argument; for example:

```
# dvhtool /dev/rdisk/dks0d2vh
```

(See the “Device Names” in Chapter 1 for information on constructing the device name.)

2. Display the volume directory portion of the volume header by using the `vd` (volume directory) and `l` (list) commands:

```
Command? (read, vd, pt, dp, write, bootfile, or quit): vd
(d FILE, a UNIX_FILE FILE, c UNIX_FILE FILE, g FILE UNIX_FILE or l)?
l
```

Current contents:

| File name | Length | Block # |
|-----------|--------|---------|
| sgilabel  | 512    | 2       |
| sash      | 159232 | 3       |

3. For each program that you want to copy to the volume header, use the `a` (add) command. For example, to copy `sash` from the `/stand` directory to `sash` in the volume header, use this command:

```
(d FILE, a UNIX_FILE FILE, c UNIX_FILE FILE, g FILE UNIX_FILE or l)?
a /stand/sash sash
```

As another example, to copy `sash` from a CD to an IP20 or IP22 system (an Indy™), use this command:

```
(d FILE, a UNIX_FILE FILE, c UNIX_FILE FILE, g FILE UNIX_FILE or l)?
a /CDROM/stand/sashARCS sash
```

CDs contain multiple processor-specific versions of `sash`; Table 1-3 lists the version of `sash` for each processor type.

4. Confirm your changes by listing the contents of the volume with the `l` (list) command:

```
(d FILE, a UNIX_FILE FILE, c UNIX_FILE FILE, g FILE UNIX_FILE or l)?
l
```

Current contents:

| File name | Length | Block # |
|-----------|--------|---------|
| sgilabel  | 512    | 2       |
| sash      | 159232 | 3       |

5. Make the changes permanent by writing the changes to the volume header using the `quit` command to exit this “submenu” and the `write` command:

```
(d FILE, a UNIX_FILE FILE, c UNIX_FILE FILE, g FILE UNIX_FILE or l)?  
quit
```

```
Command? (read, vd, pt, dp, write, bootfile, or quit): write
```

```
Quit dvhtool by giving the quit command:
```

```
Command? (read, vd, pt, dp, write, bootfile, or quit): quit
```

## Removing Files in the Volume Header With `dvhtool`

---

**Caution:** The procedure in this section can result in the loss of data if it is not performed properly. It is recommended only for experienced IRIX system administrators.

---

You can use the following procedure to remove XLV logical volume labels (for example `xlvlab`) and files (for example, `sash`) from the volume header of a disk. Before performing this procedure, review the discussion of `dvhtool` in “Volume Headers” in Chapter 1.

1. Using `hinv`, determine the controller and drive addresses of the disk that has the volume header you want to change. In this procedure, the example commands and output assume that the disk is on controller 0, drive address 2. Substitute the controller and drive addresses of your disk.
2. As `superuser`, invoke `dvhtool` with the raw device name of the volume header of the disk, for example:

```
# dvhtool /dev/rdisk/dks0d2vh
```

(See the section “Device Names” in Chapter 1 for information on constructing the device name.)

3. Display the volume directory portion of the volume header by answering two prompts:

```
Command? (read, vd, pt, dp, write, bootfile, or quit): vd
(d FILE, a UNIX_FILE FILE, c UNIX_FILE FILE, g FILE UNIX_FILE or l)?
1
```

Current contents:

| File name | Length | Block # |
|-----------|--------|---------|
| sgilabel  | 512    | 2       |
| xlvlab    | 10752  | 3       |
| lvlab2    | 512    | 26      |

4. Use the `d` command to delete the file; for example, `xlvlab`:

```
(d FILE, a UNIX_FILE FILE, c UNIX_FILE FILE, g FILE UNIX_FILE or l)?
d xlvlab
```

5. To delete additional files, continue to use the `d` command, for example:

```
(d FILE, a UNIX_FILE FILE, c UNIX_FILE FILE, g FILE UNIX_FILE or l)?
d lvlab2
```

6. List the volume directory again to confirm that the files are gone:

```
(d FILE, a UNIX_FILE FILE, c UNIX_FILE FILE, g FILE UNIX_FILE or l)?
1
```

Current contents:

| File name | Length | Block # |
|-----------|--------|---------|
| sgilabel  | 512    | 2       |

7. Exit this “menu” and write the changes to the volume header:

```
(d FILE, a UNIX_FILE FILE, c UNIX_FILE FILE, g FILE UNIX_FILE or l)?
q
```

```
Command? (read, vd, pt, dp, write, bootfile, or quit): write
```

8. Quit `dvhtool`:

```
Command? (read, vd, pt, dp, write, bootfile, or quit): quit
```

## Displaying a Disk's Partitions With `prtvtoc`

Use the `prtvtoc` command to get information about the size and partitions of a disk. Only the superuser can use this command. The command is

```
# prtvtoc device
```

where *device* is optional. When it is omitted, `prtvtoc` displays information for the system disk. *device* is the raw device name of the disk volume header. The `/dev/rdisk` portion of the device name can be omitted if desired. For example, for a SCSI disk that is drive address 1 on controller 0, *device* is `cdks0d1vh`. (See "Device Names" in Chapter 1 for more information on device names.)

An example of the output of `prtvtoc` is:

```
Printing label for root disk
```

```
* /dev/root (bootfile "/unix")
*      512 bytes/sector
Partition  Type  Fs   Start: sec      Size: sec   Mount Directory
  0          xfs  yes      4096          4138249
  1          raw                4142345          262144
  8          volhdr                0              4096
 10          volume                0          4404489
```

The output lists the partitions, their type (name or filesystem type), whether they contain a filesystem, their location on the disk (start and size in blocks and cylinders), and mount directory for filesystems. The partitions in this output are shown graphically in Figure 1-6.

## Repartitioning a Disk With `xdkm`

Disks can be repartitioned using the graphical user interface of the `xdkm` command. Information about `xdkm` is available from its online help.

## Repartitioning a Disk With fx

---

**Caution:** The procedure in this section can result in the loss of data if it is not performed properly. It is recommended only for experienced IRIX system administrators.

---

Repartitioning disks is done from the command line with the `fx` command. There are two versions of this program, a standalone version and an IRIX version. The standalone version is invoked from the **Command Monitor**, which enables you to repartition the system disk. Option disks can be repartitioned using the IRIX version.

The subsections that follow describe the procedures for repartitioning a disk. Start with the first subsection, “Before Repartitioning.” Then proceed to the appropriate subsection on invoking `fx`:

- “Invoking `fx` From the Command Monitor” on page 28
- “Invoking `fx` From IRIX” on page 30

The standard partition layouts described in “System Disks, Option Disks, and Partition Layouts” in Chapter 1 are “built in to” `fx`. You can partition a disk using one of the standard layouts or you can create custom partition layouts. Two subsections describe how to create standard and custom partition layouts:

- “Creating Standard Partition Layouts” on page 31
- “Creating Custom Partition Layouts” on page 32

The final subsection, “After Repartitioning” on page 36, describes how to proceed after the repartitioning is complete.

## Before Repartitioning

---

**Caution:** Repartitioning a disk makes the data on the disk inaccessible (you must repartition back to the original partitions to get to it).

---

Before repartitioning a disk, back up any files that contain valuable data. If the disk is a system disk and you plan to copy the files from the backup to the disk after repartitioning, you must use either the **System Manager** or the `backup` command. Only backups made with `backup` or the **System Manager** will be available to the system from the **System Recovery** menu of the **System Maintenance** menu. The **System Manager** is the preferred method of the two and is described completely in the *Personal System Administration Guide*. Other commands require a full system installation to operate correctly.

## Invoking `fx` From the Command Monitor

The procedure in this section describes how to invoke the standalone version of `fx` from the **Command Monitor**. It is only necessary for the system disk. You can use the IRIX version of `fx` for other disks (see, “Invoking `fx` From IRIX” on page 30).

1. Shut the system down into the **System Maintenance** menu.
2. Bring up the **Command Monitor** by choosing the fifth item on the **System Maintenance** menu.
3. Identify the copy of `fx` that you will boot. Some possible locations are: `fx` in the `/stand` directory of the system disk or `fx` on an IRIX software distribution CD in a CD-ROM drive on the local system or on a remote system.

A single copy of `fx` is in the `/stand` directory, but IRIX software distribution CDs contain several processor-specific versions of `fx`. Booting `fx` from a CD on a local CD-ROM drive requires a processor-specific copy of `sash` on the CD, too.



Table 2-1 shows which versions of `sash` and `fx` to use according to your processor type.

**Table 2-1** sash and fx Versions

| Processor Type         | sash Version | fx Version |
|------------------------|--------------|------------|
| IP17                   | sashIP17     | fx.IP17    |
| IP19, IP20, IP22       | sashARCS     | fx.ARCS    |
| IP21, IP25, IP26, IP27 | sash64       | fx.64      |

4. Boot `fx` from the **Command Monitor**. The command to boot `fx` depends upon the location of the copy of you are booting.
  - This command boots `fx` from the `/stand` directory on the system disk:
 

```
>> boot stand/fx --x
```
  - This command boots `fx` from an IRIX software release CD in a local CD-ROM drive, where the CPU type of the system is IP19, IP20, or IP22 and the CD-ROM drive is at drive address 4 on controller 0:
 

```
>> boot -f dksc(0,4,8)sashARCS dksc(0,4,7)stand/fx.ARCS --x
```
  - This command boots `fx` from an IRIX software release CD in a CD-ROM drive mounted at `/CDROM` on a remote system named `dist`, where the CPU type of the local system is IP21, IP25, IP26, or IP27:
 

```
>> boot -f bootp()dist:/CDROM/stand/fx.64 --x
```
5. `fx` prompts you for each part of the disk name. The default answer is in parentheses and matches the system disk. The prompts are:

```
fx: "device-name" = (dksc)
fx: ctrlr# = (0)
fx: drive# = (1)
fx: lun# = (0)
```

The default device name is `dksc`, which indicates a SCSI disk on a SCSI controller. (See the `fx(1M)` reference page for other device names.) The next two prompts ask you to specify the disk controller number and the drive address (unit) of the disk. The final prompt asks for the lun (logical unit) number. The logical unit number is typically used by only a few SCSI devices such as RAIDs (an array of disks with built-in redundancy) to address disks within the device. For regular disks, use logical unit number 0.

For each prompt, press the Enter key for the default value or enter another value, followed by Enter.

Once you answer the prompts, `fx` performs a disk drive test and you see the `fx` main menu:

```
---- please choose one (? for help. .. to quit this menu)----
[exi]t                [d]ebug/                [l]abel/
[b]adblock/          [ex]ercise/            [r]epartition/
fx>
```

The `exit` option quits `fx`, while the other commands take you to submenus. (The slash [/] character after a menu option indicates that choosing that option leads to a submenu.) For complete information on all `fx` options, see the `fx(1M)` reference page.

## Invoking `fx` From IRIX

The procedure in this section describes how to invoke `fx` from IRIX.

1. Make sure that the disk drive to be partitioned is not in use. That is, make sure that no filesystems are mounted and no programs are accessing the drive.
2. As superuser, give the `fx` command:

```
# fx "controller_type(controller,address,logical_unit)"
```

The variables are:

*controller\_type* The controller type. It is `dksc` for SCSI controllers. For other controller types, see the `fx(1M)` reference page.

*controller* The controller number for the disk.

*address* The drive address of the disk.

*logical\_unit* The logical unit number for the device. It is used by only a few SCSI devices such as RAIDs (an array of disks with built-in redundancy) to address disks within the device. The *logical\_unit* is normally 0.

If you give the `q` command without arguments, you are prompted for these values.

`fx` first performs a drive test, then displays this menu:

```
---- please choose one (? for help. .. to quit this menu)----
[exi]t                [d]ebug/                [l]abel/
[b]adblock/          [ex]ercise/            [r]epartition/
fx>
```

The `exit` option quits `fx`, while the other commands take you to submenus. (The slash [/] character after a menu option indicates that choosing that option leads to a submenu.) For complete information on all `fx` options, see the `fx(1M)` reference page.

## Creating Standard Partition Layouts

This section shows the procedure for repartitioning a disk so that it has one of the standard partition layouts. The example in this section changes a disk from separate `root` and `usr` partitions to a combined `root` and `usr` partition.

1. From the `fx` main menu, choose the `repartition` option:

```
---- please choose one (? for help. .. to quit this menu)----
[exi]t          [d]ebug/          [l]abel/
[b]adblock/    [ex]ercise/      [r]epartition/
fx> repartition
```

```
----- partitions-----
part  type          blocks          Megabytes   (base+size)
  0:  efs            3024 + 50652    1 + 25
  1:  raw            53676 + 81648   26 + 40
  6:  efs           135324 + 1925532 66 + 940
  8:  volhdr         0 + 3024        0 + 1
 10:  volume         0 + 2060856    0 + 1006
```

```
capacity is 2061108 blocks
```

```
----- please choose one (? for help, .. to quit this menu)-----
[ro]otdrive    [o]ptiondrive    [e]xpert
[us]rrootdrive [re]size
```

You see the partition layout for the disk that you specified when `fx` was started, followed by the `repartition` menu. The `rootdrive`, `usrrootdrive`, and `optiondrive` options are used for standard partition layouts, and the `resize` option is used for custom partition layouts. The `expert` option, which appears only if `fx` is invoked with the `-x` option, enables custom partitioning functions. These functions can severely damage the disk when performed incorrectly, so they are unavailable unless explicitly requested with `-x`.

- To create a combined root and usr partition, choose the rootdrive option.

```
fx/repartition> rootdrive
```

- A prompt appears that asks about the partition type. The possible types are shown in Table 1-2. For this example, choose efs:

```
fx/repartition/rootdrive: type of data partition = (xfs) efs
```

- A warning appears; answer yes to the prompt after the warning:

```
Warning: you will need to re-install all software and restore user data
from backups after changing the partition layout. Changing partitions
will cause all data on the drive to be lost. Be sure you have the drive
backed up if it contains any user data. Continue? yes
```

```
----- partitions-----
part  type          blocks          Megabytes   (base+size)
0:    efs            3024 + 1976184    1 + 965
1:    raw           1979208 + 81648   966 + 40
8:    volhdr        0 + 3024          0 + 1
10:   volume        0 + 2060856       0 + 1006
```

```
capacity is 2061108 blocks
```

```
----- please choose one (? for help, .. to quit this menu)-----
[ro]otdrive      [u]srootdrive    [o]ptiondrive    [r]esize
```

The partition layout after repartitioning is displayed and the repartition submenu appears again.

- To return to the fx main menu, enter .. at the prompt:

```
fx/repartition> ..
```

```
----- please choose one (? for help, .. to quit this menu)-----
[exi]t          [d]ebug/        [l]abel/
[b]adblock/     [ex]rcise/      [r]epartition/
fx>
```

## Creating Custom Partition Layouts

The following procedure describes how to repartition a disk so that it has a custom partition layout. As an example, this procedure repartitions a 380 MB SCSI drive to increase the size of the root partition.

1. At the fx main menu, choose the repartition command:

```

---- please choose one (? for help. .. to quit this menu)----
[exi]t          [d]ebug/          [l]abel/
[b]adbblock/    [ex]ercise/        [r]epartition/
fx> repartition
----- partitions-----
part  type          blocks          Megabytes   (base+size)
  0:  efs            2835 + 32400    1 + 16
  1:  rawdata       35235 + 81810   17 + 40
  6:  efs           117045 + 513945 57 + 251
  7:  efs            2835 + 628155   1 + 307
  8:  volhdr         0 + 2835        0 + 1
 10:  entire         0 + 630990      0 + 308

capacity is 631017 blocks

----- please choose one (? for help, .. to quit this menu)-----
[ro]otdrive     [u]srrootdrive   [o]ptiondrive    [re]size

```

You see the partition layout for the disk that you specified when fx was started, followed by the repartition menu. Look at the size column for partitions 0, 1, and 6. In this example, you have  $32400 + 81810 + 513945 = 628155$  blocks to use. Look at the start block numbers, and notice that partition 7 overlaps 0, 1, and 6. Partition 0 is the root filesystem, and is mounted on the system's root directory (/). Partition 1 is your system's swap space. Partition 6 is the usr filesystem, and it is mounted on the /usr directory. In this example, you will take space from the usr filesystem and expand the root filesystem.

2. Choose the `resize` option to change the size of partitions on the disk and answer `y` to the warning message:

```
fx/repartition> resize
```

```
Warning: you will need to re-install all software and restore user data
from backups after changing the partition layout. Changing partitions
will cause all data on the drive to be lost. Be sure you have the drive
backed up if it contains any user data. Continue? y
```

After changing the partition, the other partitions will be adjusted around it to fit the change. The result will be displayed and you will be asked whether it is OK, before the change is committed to disk. Only the standard partitions may be changed with this function. Type `?` at prompts for a list of possible choices

3. The prompt after the warning message offers the swap space partition as the default partition to change, but in this example you will designate the root partition to be resized. Enter `root` at the prompt:

```
fx/repartition/resize: partition to change = (swap) root
current:  type efs          base:      2835 blks,    1 Mb
          len:      32400 blks, 16 Mb
```

4. The next prompt asks for the partitioning method (partition size units) with megabytes as the default. Other options are to use percentages of total disk space or numbers of disk blocks. Megabytes and percentages are the easiest methods to use to partition your disk. Press `Enter` to use megabytes as the method of repartitioning:

```
fx/repartition/resize: partitioning method = (megabytes (2^20 bytes)) Enter
```

5. The next prompt asks for the size of the root partition in megabytes. The default is the current size of the partition. For this example, increase the size to 20 MB:

```
fx/repartition/resize: size in megabytes (max 307) = (16) 20
----- partitions-----
part  type          blocks          Megabytes    (base+size)
  0:  efs            2835 + 40960      1 + 20
  1:  rawdata       43795 + 73250     21 + 36
  6:  efs          117045 + 513945   57 + 251
  8:  volhdr         0 + 2835          0 + 1
 10:  entire         0 + 630990        0 + 308
```

The new partition map is displayed. Note that the 4 megabytes that you added to your root partition were taken from the swap partition. Ultimately, you want those megabytes to come from the `usr` partition, but for the moment, accept the new partition layout.

6. To accept the new partition layout, enter `yes` at the prompt:

```
Use the new partition layout? (no) yes
```

The new partition table is printed again, along with the total disk capacity. Then you are returned to the repartition menu.

7. Select `resize` again to transfer space from the `usr` partition to the swap area:

```
fx/repartition> resize
```

You see the same warning message again.

8. At the partition to change prompt, press `Enter` to change the size of the swap partition:

```
fx/repartition/resize: partition to change = (swap) Enter
current:  type raw          base:    43795 blks,    21 Mb
                len:    73250 blks,    36 Mb
```

9. Press `Enter` again to use megabytes as the method of repartition:

```
fx/repartition/resize: partitioning method = (megabytes (2^20 bytes)) Enter
```

10. The next prompt requests the new size of the swap partition. Since you added 4 megabytes to expand the root filesystem from 16 to 20 megabytes, enter 40 and press `Enter` at this prompt to expand the swap space to its original size. (If your system is chronically short of swap space, you can take this opportunity to add some space by entering a higher number.)

```
fx/repartition/resize: size in megabytes (max 307) = (36) 40
----- partitions-----
part  type          blocks          Megabytes    (base+size)
  0:  efs            2835 + 40960          1 + 20
  1:  rawdata       43795 + 81920         21 + 40
  6:  efs          125715 + 505275        61 + 247
  8:  volhdr         0 + 2835              0 + 1
 10:  entire        0 + 630990            0 + 308
```

You see the new partition table. Note that the partition table now reflects that 4 megabytes have been taken from partition 6 (`usr`) and placed in the swap partition.

11. At the prompt, enter `yes` to accept the new partition layout:

```
Use the new partition layout? (no) yes
```

The new partition table and the repartition submenu are displayed again.

12. Enter `..` at the prompt to return to the `fx` main menu:

```
fx/repartition> ..
```

```
----- please choose one (? for help, .. to quit this menu)-----
[exi]t          [d]ebug/        [l]abel/
[b]adbblock/    [ex]rcise/      [r]epartition/
fx>
```

## After Repartitioning

1. From the `fx` main menu, enter `exit` to quit `fx`.  
`fx> exit`
2. If you repartitioned the system disk, you must now install software on it in one of two ways:
  - Bring up the miniroot (choose Install System Software from the **System Maintenance** menu); use the `mkfs` command on the **Administrative Commands** menu to make filesystems on the disk partition; and install an IRIX release and optional software.
  - Choose System Recovery from the **System Maintenance** menu and use the backup or system manager backup tape you created earlier to return the original files to the disk.

If you repartitioned an option disk, use the `mkfs` command to create new filesystems on the disk partitions.
3. Restore user files from backup tapes as necessary.

## Creating Mnemonic Names for Device Files With `ln`

Device file names, for example `/dev/dsk/dks0d1s0` and `/dev/rdisk/dks0d2s7`, can be difficult to remember and type. *Mnemonic device names* can solve this problem. They are filenames in the `/dev` directory that are symbolic links to the real device files. By default, IRIX has several of these mnemonic device file names. For example, `/dev/root` is a mnemonic device file name for `/dev/dsk/dks0d1s0` (or whatever partition contains the root filesystem) and `/dev/rswap` is a mnemonic device file name for `/dev/rdisk/dks0d1s1` (or whatever partition is the swap partition). You can create additional mnemonic device file names using the `ln` command:

```
# ln device_file mnemonic_name
```

For more information on the `ln` command, see the `ln(1)` reference page.



## Creating a System Disk From the PROM Monitor

This section describes how to install a system disk on a system that does not currently have a working system disk. It is used in these situations:

- The new disk has no formatting or partitioning information on it at all, or the partitioning is incorrect.
- It is an option disk that you must turn into a system disk.

If the system already has a working disk, you can use the procedure in “Creating a New System Disk From IRIX” on page 42

To turn a disk into a system disk, you must have an IRIX system software release CD available and a CD-ROM drive attached to the system or available on the network. If you are using a CD-ROM drive attached to a system on the network, that system must be set up as an installation server. See the *IRIX Admin: Software Installation and Licensing* guide for instructions.

These instructions assume that the system disk is installed on controller 0 at drive address 1. This is the standard location for workstations; the controller number is system-specific on servers. Follow these steps:

1. Bring the system up into the **System Maintenance** menu.
2. Invoke the **Command Monitor** by choosing the fifth item on the **System Maintenance** menu.
3. Issue the `hinv` command, and use the CPU type and Table 2-1 to determine the version of standalone `fx` that you need to invoke. For example, a system with an IP19 processor is an ARCS processor, so the version of standalone `fx` needed is `stand/fx.ARCS`.
4. Determine the controller and drive address of the device that contains the copy of `fx` that you plan to use (a CD-ROM drive attached to the system or a CD-ROM drive on a workstation on the network). For example, for a local CD-ROM drive, if `hinv` reports that the CD-ROM drive on the system is `scsi(0), cdrom(4)`, the controller is 0 and the drive address is 4. The remainder of this example uses that device, although your device may be different or may be located on a different workstation.
5. If you are installing over a network connection, get the IP address of the workstation with the CD-ROM drive.
6. Insert the CD containing the IRIX system software release into the CD-ROM drive.

7. Give a **Command Monitor** command to boot `fx`. For this example the command is:

```
>> boot -f dksc(0,4,8)sashARCS dksc(0,4,7)stand/fx.ARCS --x
72912+9440+3024+331696+23768d+3644+5808 entry: 0x89f9a950
112784+28720+19296+2817088+59600d+7076+10944 entry: 0x89cd74d0
SGI Version 5.3 ARCS Oct 18, 1994
```

See Appendix A of the guide *IRIX Admin, Software Installation and Licensing* for a complete listing of appropriate commands to boot `fx` from CD-ROM on this or another workstation.

8. Respond to the prompts by pressing the Enter key. These responses select the system disk:

```
fx: "device-name" = (dksc)
fx: ctrlr# = (0) Enter
fx: drive# = (1) Enter
fx: lun# = (0)
...opening dksc(0,1,)
...drive selftest...OK
Scsi drive type == SGI SEAGATE ST31200N8640

----- please choose one (? for help, .. to quit this menu)-----
[exi]t          [d]ebug/        [l]abel/        [a]uto
[b]adbblock/    [exelrcise/     [r]epartition/  [f]ormat
```

9. Display the partitioning of the disk with the `repartition` command:

```
fx> repartition

----- partitions-----
part  type          blocks          Megabytes   (base+size)
   7:  efs           3048 + 2074164    1 + 1013
   8:  volhdr         0 + 3048          0 + 1
  10:  volume         0 + 2077212      0 + 1014

capacity is 2077833 blocks
```

Check the partition layout to see whether the disk needs repartitioning. See “System Disks, Option Disks, and Partition Layouts” in Chapter 1 for information about standard partition layouts.

10. If the disk doesn’t need repartitioning, skip to step 13.
11. Choose a disk partition layout. You can choose a standard system disk partition layout (described in “System Disks, Option Disks, and Partition Layouts” in Chapter 1) or a custom partition layout.

12. If you choose a standard system disk partition layout, follow the directions in “Creating Standard Partition Layouts” on page 31. If you choose a custom partition layout, follow the instructions in “Creating Custom Partition Layouts” on page 32.
13. In preparation for a future step, check the contents of the volume header by giving this command:

```

----- please choose one (? for help, .. to quit this menu)-----
[ro]otdrive          [o]ptiondrive      [e]xpert
[us]rrootdrive      [re]size
fx/repartition> label/show/directory

0: sgilabel  block   3 size   512  2: sash          block 1914 size 159232
1: ide       block   4 size  977920

```

Verify that the volume header contains sash, a required file (it is listed as item 2 in this example).

14. Quit fx and the **Command Monitor** so that you return to the **System Maintenance** menu:

```

----- please choose one (? for help, .. to quit this menu)-----
[para]meters        [part]itions      [b]ootinfo        [a]ll
[g]eometry          [s]giinfo        [d]irectory
fx/label/show> ../../exit
>> exit

```

15. Choose the second option, **Install System Software**, from the **System Maintenance** menu.

Because there is no filesystem on the root partition, error messages may appear. One example is the following message:

Mounting file systems:

```

/dev/dsk/dks0d1s0: Invalid argument
No valid file system found on: /dev/dsk/dks0d1s0
This is your system disk: without it we have nothing
on which to install software.

```

Another possible message indicates a problem, but does mount the root partition and bring up inst:

Mounting file systems:

```

mount: /root/dev/usr on /root/usr: No such file or directory
mount: giving up on:
      /root/usr

```

```
Unable to mount all local efs, xfs file systems under /root
Copy of above errors left in /root/etc/fscklogs/miniroot
```

```
    /dev/miniroot          on  /
    /dev/dsk/dks0d1s0      on  /root
```

Invoking software installation.

### 16. If the system offers to make a filesystem, answer **yes** to the prompts:

```
Make new file system on /dev/dsk/dks0d1s0 [yes/no/sh/help]: yes
```

```
About to remake (mkfs) file system on: /dev/dsk/dks0d1s0
This will destroy all data on disk partition: /dev/dsk/dks0d1s0.
```

```
Are you sure? [y/n] (n): yes
```

```
Block size of filesystem 512 or 4096 bytes? 4096
```

```
Doing: mkfs -b size=512 /dev/dsk/dks0d1s0
meta-data=/dev/rdisk/dks0d1s0      isize=256    agcount=8, agsize=248166 blks
data      =                        bsize=4096  blocks=248165
log       =internal log           bsize=512   blocks=1000
realtime =none                    bsize=4096  blocks=0, rtextents=0
Mounting file systems:
```

```
NOTICE: Start mounting filesystem: /root
NOTICE: Ending clean XFS mount for filesystem: /root
    /dev/miniroot          on  /
    /dev/dsk/dks0d1s0      on  /root
```

### 17. If the system offers to put you into a shell, go into the shell and manually make the root and, if appropriate, the usr filesystem. For example:

Please manually correct your configuration and try again.

```
Press Enter to invoke C Shell csh: Enter
```

```
# mkfs /dev/dsk/dks0d1s0
meta-data=/dev/dsk/dks0d1s0      isize=256    agcount=8, agsize=31021 blks
data      =                        bsize=4096  blocks=248165
log       =internal log           bsize=4096  blocks=1000
realtime =none                    bsize=4096  blocks=0, rtextents=0
# exit
```

18. If the `inst` main menu comes up and you did not make a root filesystem in step 16 or step 17, make the root and, if used, the `usr` filesystems, and mount them. For example:

```
Inst> admin
...
Admin> mkfs /dev/dsk/dks0d1s0

Make new file system on /dev/dsk/dks0d1s0 [yes/no/sh/help]: yes

About to remake (mkfs) file system on: /dev/dsk/dks0d1s0
This will destroy all data on disk partition: /dev/dsk/dks0d1s0.

Are you sure? [y/n] (n): yes

Block size of filesystem 512 or 4096 bytes? 4096

Doing: mkfs -b size=512 /dev/dsk/dks0d1s0
meta-data=/dev/rdsk/dks0d1s0   isize=256   agcount=8, agsize=248166 blks
data      =                    bsize=4096   blocks=248165
log       =internal log       bsize=512   blocks=1000
realtime =none                 bsize=4096   blocks=0, rtextents=0
Mounting file systems:

NOTICE: Start mounting filesystem: /root
NOTICE: Ending clean XFS mount for filesystem: /root
/dev/miniroot          on /
/dev/dsk/dks0d1s0      on /root

Re-initializing installation history database
Reading installation history .. 100% Done.
Checking dependencies .. 100% Done.

Admin> Enter
```

19. Install IRIX software from the CD as usual.
20. Install option software and patches from other CDs, if desired.
21. If you don't need to modify the volume header to add `sash` (see step 13), you have finished creating the new system disk. You don't need to do the remaining steps in this procedure.

22. In preparation for adding programs to the volume header of the disk, start a shell:

```
Inst> sh
```

23. Follow the instructions in the procedure in “Adding Files to the Volume Header With `dvhtool`” on page 22 to add `sash`, if necessary, to the volume header of the system disk. Remember that the `/stand` directory is mounted at `/root/stand`.

24. Exit from the shell:

```
# exit
```

25. Quit `inst` and bring up the system as usual.

```
Inst> quit
```

## Creating a New System Disk From IRIX

This procedure describes how to turn an option disk into a system disk. The option disk does not need to have a filesystem or be mounted prior to starting the procedure.

---

**Caution:** The procedure in this section destroys all data on the option disk. If the option disk contains files that you want to save, back up all files on the option disk to tape or another disk before beginning this procedure.

---

You can use this procedure when you want to change to a larger system disk, for example from a 1 GB disk to a 2 GB disk, or when you want to create a system disk that you can move to another system. With this procedure, you create a “fresh” disk by installing software from an IRIX system software CD. (To create an exact copy of a system disk, use “Creating a New System Disk by Cloning” on page 46 instead.) Note that if you plan to create a system disk for another system, the systems must be identical because of hardware dependencies in IRIX.

You must perform this procedure as superuser. The procedure requires several system reboots, so other users should not be using the system.

Follow these steps to convert an option disk to a system disk:

1. Using `hinv`, determine the controller and drive addresses of the disk to be turned into a system disk. In this procedure, the example commands and output assume that the disk is on controller 0 and drive address 2. Substitute your controller and drive address throughout these instructions.
2. To repartition the disk so that it can be used as a system disk, begin by invoking `fx`:

```
# fx
fx version 6.4, Sep 29, 1996
```

3. Answer the prompts with the correct controller number and drive address for the disk you are converting and 0 for the lun number, for example:

```
fx: "device-name" = (dksc) Enter
fx: ctrlr# = (0) Enter
fx: drive# = (1) 2
fx: lun# = (0) Enter
...opening dksc(0,2,0)
...drive selftest...OK
Scsi drive type == SGI          SEAGATE ST31200N8640

----- please choose one (? for help, .. to quit this menu)-----
[ex]it          [d]ebug/          [l]abel/
[b]ladbblock/  [ex]rcise/        [r]epartition/
```

4. Enter the repartition command:

```
fx> repartition

----- partitions-----
part  type          blocks          Megabytes  (base+size)
   7:  efs           3024 + 2057832    1 + 1005
   8:  volhdr         0 + 3024          0 + 1
  10:  volume         0 + 2060856       0 + 1006

capacity is 2061108 blocks
```

5. Choose `rootdrive` or `usrrootdrive`, depending on whether you want a combined root and `usr` partition or separate root and `usr` partitions. (See the section "System Disks, Option Disks, and Partition Layouts" in Chapter 1 for advantages and disadvantages of each.) In this example, a combined root and `usr` disk, configured for XFS, is chosen:

```
----- please choose one (? for help, .. to quit this menu)-----
[ro]otdrive    [u]srrootdrive  [o]ptiondrive   [re]size
```

```
fx/repartition> rootdrive
```

```
fx/repartition/rootdrive: type of data partition = (xfs) Enter  
Warning: you will need to re-install all software and restore user data  
from backups after changing the partition layout. Changing partitions  
will cause all data on the drive to be lost. Be sure you have the drive  
backed up if it contains any user data. Continue? y
```

```
----- partitions-----  
part  type          blocks          Megabytes   (base+size)  
  0:  xfs            3024 + 1976184      1 + 965  
  1:  raw           1979208 + 81648     966 + 40  
  8:  volhdr         0 + 3024            0 + 1  
 10:  volume         0 + 2060856         0 + 1006
```

```
capacity is 2061108 blocks
```

#### 6. Quit fx:

```
----- please choose one (? for help, .. to quit this menu)-----  
[r]o[ot]drive      [u]s[r]rootdrive    [o]p[tion]drive    [re]size  
fx/repartition> ../exit
```

7. Use the procedure in “Adding Files to the Volume Header With `dvhtool`” on page 22 to examine the contents of the volume header of the disk to be converted and to add `sash` to its volume header if it is not there already.

8. Make a root filesystem on the root partition of the disk you are converting. For example, to make an XFS root filesystem with 4 KB block size and a 1000 block internal log (the default values), give this command:

```
# mkfs /dev/dsk/dks0d2s0
```

For additional instructions on making an XFS filesystem, see “Planning an XFS Filesystem” and “Making an XFS Filesystem” in Chapter 6. There is no need to mount the filesystem after making it.

9. If the disk has a separate `usr` partition, make a filesystem on that partition, too. For example:

```
# mkfs /dev/dsk/dks0d2s6
```

10. Insert a CD containing the IRIX release you plan to install into either your system’s CD-ROM drive or a CD-ROM drive on a remote system.

11. Shut down the system and bring up the miniroot from the CD. For instructions, see the guide *IRIX Admin: Software Installation and Licensing*.



12. Switch to the **Administrative Commands** menu, unmount the root and `usr` (if used) partitions from the old system disk, and mount the root and `usr` (if used) partitions of the new disk in their place. For example, if the old system disk has root and `usr` partitions and the new system disk has only a root partition, the commands are:

```
Inst> admin
Admin> umount /root
Admin> umount /root/usr
Admin> mount /dev/dsk/dks0d2s0 /root
Admin> Enter
```

13. Confirm that the root and `usr` (if used) partitions of the new system disk are mounted as `/root` and `/root/usr` (if used). This example shows the output for the example in step 12:

```
Inst> sh df
```

| Filesystem        | Type | blocks  | use   | avail   | %use | Mounted on |
|-------------------|------|---------|-------|---------|------|------------|
| /dev/miniroot     | xfs  | 49000   | 32812 | 16188   | 67   | /          |
| /dev/dsk/dks0d1s0 | xfs  | 1984325 | 251   | 1984074 | 0    | /root      |

---

**Caution:** If the wrong partitions are mounted, `inst` installs system software onto the wrong partitions, which destroys the data on those partitions.

---

14. Install system software from this CD and options and patches from other CDs as usual. Instructions are in the guide *IRIX Admin: Software Installation and Licensing*.
15. Quit `inst` and bring the system back to IRIX (the system boots the old system disk).
16. To test the new system disk before replacing the old system disk or moving the disk to a different system, begin by shutting down the system to the PROM Monitor.
17. Bring up the **Command Monitor** by choosing the fifth item on the **System Maintenance** menu.
18. Boot the system in single user mode from the new system disk by issuing the following commands. This example uses controller 0 and drive address 2; substitute the values for the new system disk in the first and second positions of each of the three triples of numbers in this example.

```
>> setenv initstate s
>> boot -f dksc(0,2,8)sash dksc(0,2,0)unix root=dks0d2s0
```

19. Run MAKEDEV and autoconfig:

```
# cd /dev
# ./MAKEDEV
# /etc/autoconfig -f
```

20. Restart the system in multiuser mode with the `reboot` command.

The new system disk is ready to replace the system disk on this system or another system with the same hardware configuration.

## Creating a New System Disk by Cloning

This procedure describes how to turn an option disk into an exact copy of a system disk. Use this procedure when you want to set up two or more systems with identical system disks. The systems must have identical processor and graphics types.

---

**Caution:** The procedure in this section destroys all data on the option disk. If the option disk contains files that you want to save, back up all files on the option disk to tape or another disk before beginning this procedure.

---

You must perform this procedure as superuser. To ensure that the system disk that you create is identical to the original system disk, the system should be in single user mode.

1. List the disk partitioning of the system (root) disk by invoking `prtvtoc` without parameters, for example:

```
# prtvtoc
Printing label for root disk

* /dev/root (bootfile "/unix")
*      512 bytes/sector
Partition Type Fs Start: sec Size: sec Mount Directory
0      xfs yes      4096      4138249
1      raw      4142345      262144
8      volhdr      0      4096
10     volume      0      4404489
```

- List the disk partitioning of the option disk that is to be the clone, for example:

```
# prtvtoc /dev/rdisk/dks0d2vh
...
Partition  Type  Fs   Start: sec   Size: sec   Mount Directory
0          efs             3024       50652
1          raw           53676       81648
6          efs          135324     1925532
8          volhdr         0           3024
10         volume         0       2060856
```

- Compare the disk partitioning of the two disks. They must have the same layout for the root and (if used) the `usr` partition. If they are not the same, repartition the option disk to match the system disk using the procedure in “Repartitioning a Disk With `fx`” on page 27.
- Use the procedure in “Adding Files to the Volume Header With `dvhtool`” on page 22 to check the contents of the volume header of the option disk and add programs, if necessary, by copying them from the system disk.
- Make a new filesystem on the root partition of the option disk. For example, to make an XFS root filesystem with a 4 KB block size and a 1000 block internal log (the default values), give this command:

```
# mkfs /dev/dsk/dks0d2s0
```

For additional instructions on making an XFS filesystem, see “Planning an XFS Filesystem” and “Making an XFS Filesystem” in Chapter 6. There is no need to mount the filesystem after making it.

- If there is a separate `usr` partition, make a new filesystem on the `usr` partition of the option disk, for example:

```
# mkfs /dev/dsk/dks0d2s6
```

- Create a temporary mount point for the option disk filesystems, for example:

```
# mkdir /clone
```

- Mount the root filesystem of the option disk and change directories to the mount point, for example:

```
# mount /dev/dsk/dks0d2s0 /clone
# cd /clone
```

9. Use `dump` (for EFS filesystems) or `xfsdump` (for XFS filesystems) to copy the root filesystem on the system disk to the root filesystem of the option disk. The dump command is:

```
# dump 0f - / | restore xf -
```

The `xfsdump` command is:

```
# xfsdump -l 0 - / | xfsrestore - .
```

10. If the disks do not have a `usr` partition, skip to step 13.
11. In preparation for copying the `usr` filesystem, mount the `usr` filesystem instead of the root filesystem:

```
# cd ..  
# umount /clone  
# mount /dev/dsk/dks0d2s6 /clone  
# cd /clone
```

12. Use `dump` (for EFS filesystems) or `xfsdump` (for XFS filesystems) to copy the `usr` filesystem on the system disk to the `usr` filesystem of the option disk. The dump command is:

```
# dump 0f - /usr | restore xf -
```

The `xfsdump` command is:

```
# xfsdump -l 0 - /usr | xfsrestore - .
```

13. Unmount the filesystem mounted at the temporary mount point and remove the mount point, for example:

```
# cd ..  
# umount /clone  
# rmdir /clone
```

The option disk is now an exact copy of the system disk. It can be moved to a system with the same hardware configuration.

---

## Adding a New Option Disk

---

**Tip:** You can use the Disk Manager in the System Toolchest to add a new option disk. For instructions, see “Setting Up a New Hard Disk” in Chapter 3 of the *Personal System Administration Guide*. The section “Taking Advantage of a Second Disk” in Chapter 6 of the *Personal System Administration Guide* provides ideas for making effective use of an option disk.

---

To add a new option disk to a system using shell commands, follow these steps:

1. Install the hardware. See the owner’s guide for the system.
2. Initialize the volume header, if necessary. See “Formatting and Initializing a Disk With `fx`” on page 21.
3. Partition the new disk, if necessary. It should be partitioned as an option disk. See “Repartitioning a Disk With `fx`” on page 27 for instructions.
4. In preparation for the next step, identify the type of controller that the new disk is attached to (integral SCSI controller or non-integral controller). See the section “Listing the Disks on a System With `hinv`” on page 20 for instructions.
5. To add an option disk on an integral SCSI controller to a system, use the `Add_disk` command to perform the remaining steps to configure the disk:

```
# Add_disk controller_number drive_address lun_number
```

If you are adding a second disk on controller 0 to your system, you do not have to specify the disk, controller number, or logical unit number; adding disk 2 on controller 0 is the default. If you are adding a third (or greater) disk, or if you are adding a disk on a controller other than controller 0, you must specify the disk and controller. If the disk device has a logical unit number different from zero, it must be specified.

`Add_disk` checks for valid filesystems on the disk, and if any filesystems are present, you are warned and asked for permission before the existing filesystems are destroyed and a new filesystem is made.

The `Add_disk` command performs these tasks:

- Creates the character and raw device files for the new disk
- Creates an XFS filesystem on the disk
- Creates the mount directory

- Mounts the filesystem
  - Adds the mount order to the `/etc/fstab` file
6. For an option disk on a non-integral controller, complete the configuration of the new option disk by making a filesystem. Use the instructions in one of these sections in Chapter 6: “Making an XFS Filesystem” or “Making a Filesystem From inst.”

## XLV Logical Volume Concepts

This chapter explains the concepts of XLV logical volumes. The use of logical volumes allows one filesystem to spread across multiple disk partitions. IRIX supports XLV logical volumes, a logical volume design developed at Silicon Graphics. Older releases of IRIX supported an older logical volume design, 1v logical volumes. The procedure for converting from 1v logical volumes to XLV logical volumes is described in the section “Converting lv Logical Volumes to XLV Logical Volumes” in Chapter 4.

The major sections in this chapter are:

- “Introduction to XLV Logical Volumes” on page 51
- “Composition of XLV Logical Volumes” on page 54
- “XLV Logical Volume Names” on page 65
- “XLV Daemons” on page 65
- “XLV Error Policy” on page 66
- “XLV Logical Volume Planning” on page 66

Administration procedures for XLV logical volumes are described in Chapter 4, “Creating and Administering XLV Logical Volumes.”

---

**Note:** For information on XVM logical volume concepts, see the *XVM Volume Manager Administrator’s Guide*.

---

### Introduction to XLV Logical Volumes

The use of logical volumes enables the creation of filesystems, raw devices, or block devices that span more than one disk partition. Logical volumes behave like regular disk partitions; they appear as block and character devices in the /dev directory and can be used as arguments anywhere a disk device can be specified.

Filesystems can be created, mounted, and used in the normal way on logical volumes, or logical volumes can be used as block or raw devices. XLV logical volumes provide services such as disk plexing (also known as mirroring) and striping transparently to the applications that access the volumes. Key reasons to create a logical volume are:

- To allow a filesystem or disk device to be larger than the size of a physical disk
- To increase disk I/O performance

The drawback to logical volumes is that all disks used in a logical volume must function correctly at all times. If you have a logical volume set up over three disks and one disk goes bad, the information on the other two disks is unavailable and must be restored from backups. However, by using the Disk Plexing Option optional software, you can create multiple copies, called *plexes*, of the contents of XLV logical volumes, which ensures that all of the information in an XLV logical volume is available even when a disk goes bad.

When XLV logical volumes are used as raw devices and when XFS filesystems are created on them, they have these features:

- Support for very large logical volumes—up to one terabyte on 32-bit systems and unlimited on 64-bit systems.
- Support for disk striping for higher I/O performance
- Plexing (mirroring) for higher system and data reliability
- Online volume reconfigurations, such as increasing the size of a volume, for less system downtime

With XFS filesystems, XLV provides these additional advantages:

- Filesystem journal records on a separate partition, which can be on a separate disk, for maximum performance
- Access to real-time data

An XLV logical volume can include partitions from several physical disk drives. By default, data is written to the first disk partition, then to the second disk partition, and so on. Figure 3-1 shows the order in which data is written to partitions in a non-striped logical volume.



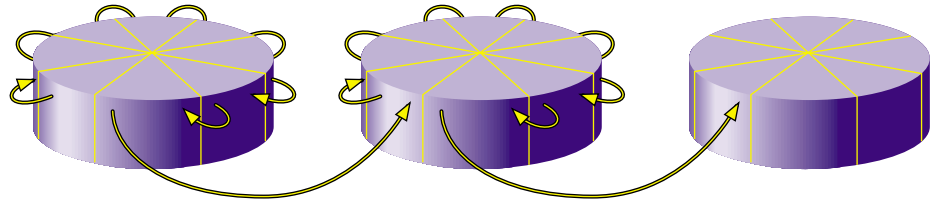

**Figure 3-1** Writing Data to a Non-Striped Logical Volume

On striped logical volumes, the volume must have equal-sized partitions on several disks. When logical volumes are striped, an amount of data, called the *stripe unit*, is written to the first disk, the next stripe unit amount of data is written to the second disk, and so on. When each of the disks have been written to, the next stripe unit of data is written to the first disk, the next stripe unit amount of data is written to the second disk, and so on to complete the “stripe.” Figure 3-2 shows the order in which data is written to a striped logical volume.

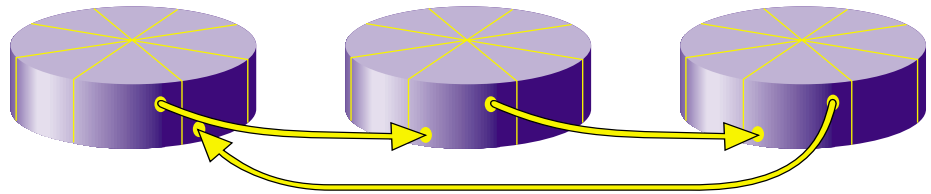

**Figure 3-2** Writing Data to a Logical Volume

Because each stripe unit in a stripe can be read and written simultaneously, I/O performance is improved. To obtain the best performance benefits of striping, try to connect the disks you are striping across on different controllers. In this arrangement, there are independent data paths between each disk and the system. However, a small performance improvement can be obtained using SCSI disks striped on the same controller.

When XFS filesystems are used on XLV volumes, each logical volume can contain up to three subvolumes: data (which is required), log, and real-time. The data subvolume normally contains user files and filesystem *metadata* (inodes, indirect blocks, directories, and free space blocks). The log subvolume is used for filesystem journal records. It is called an *external log*. If there is no log subvolume, journal records are placed in the data subvolume (an *internal log*). Data with special I/O bandwidth requirements, such as

video, can be placed on the optional real-time subvolume. The section “Using Real-Time Subvolumes” in Chapter 8 explains this procedure.

XLV increases system reliability and availability by enabling you to add or remove a copy of the data in the volume (a plex), increase the size of (grow) a volume, and replace failed elements of a plexed volume without taking the volume out of service.

You use one of two procedures to create an XLV logical volume, depending on whether you are starting with empty disks or with a filesystem on a disk partition. When starting with empty disks, you perform the following steps:

1. Create disk partitions as necessary (see “Repartitioning a Disk With `fdisk`” in Chapter 2).
2. Create the XLV logical volume (see “Creating Volume Objects With `xlvmake`” and “Example 3: Creating A Plexed XLV Logical Volume for an XFS Filesystem With an External Log” in Chapter 4).
3. Make a filesystem on the XLV logical volume (see “Making an XFS Filesystem” or “Making a Filesystem From `inst`” in Chapter 6).

In the second procedure for creating XLV logical volumes, you start with a filesystem on a disk partition. You increase the size of the filesystem (“grow” the filesystem) by creating a logical volume that includes the existing disk partition and a new disk partition. This procedure is explained in “Growing an XFS Filesystem Onto Another Disk” in Chapter 6.

Converting from `lv` logical volumes to XLV logical volumes is easy. Using the commands `lv_to_xlv` and `xlvmake`, you can convert `lv` logical volumes to XLV without having to dump and restore your data.

Using XLV logical volumes is not recommended on systems with a single disk.

## Composition of XLV Logical Volumes

XLV logical volumes are composed of a hierarchy of logical storage objects: volumes are composed of subvolumes, subvolumes are composed of plexes, and plexes are composed of volume elements. Volume elements are composed of disk partitions. This hierarchy of storage units is shown in Figure 3-3, an example of a relatively complex logical volume.

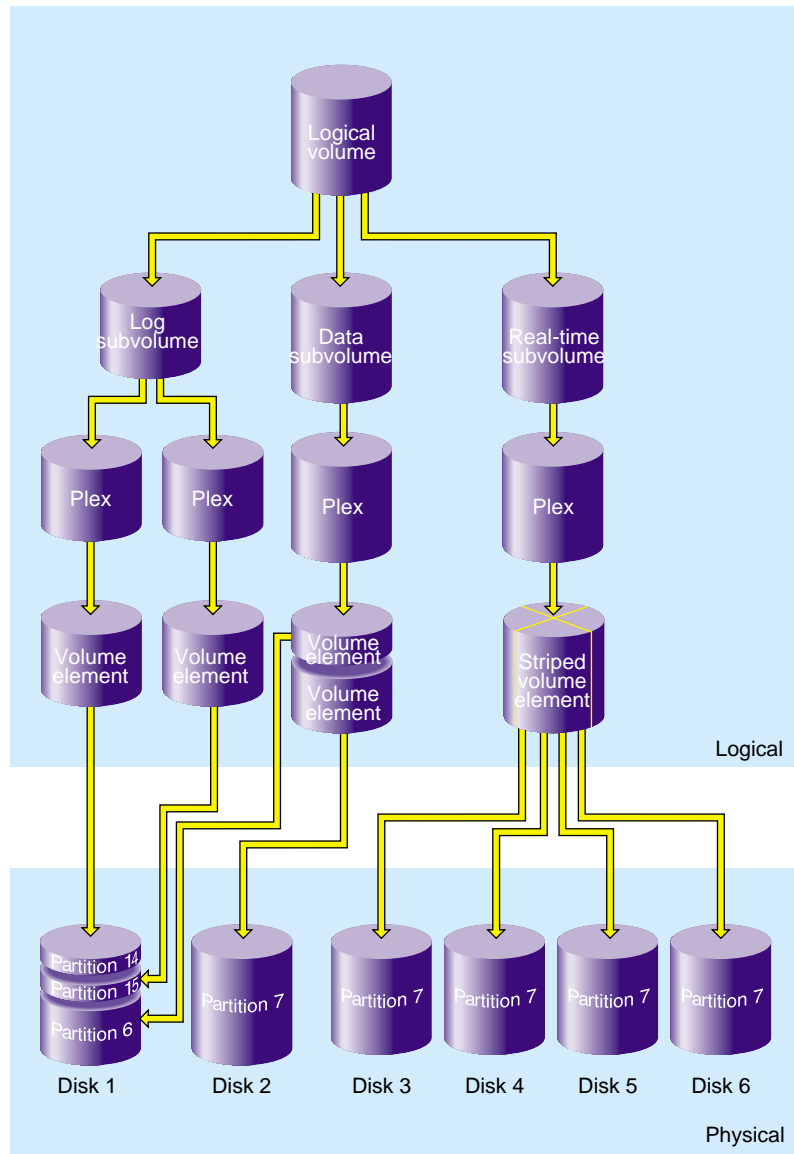

**Figure 3-3** XLV Logical Volume Example

Figure 3-3 illustrates the relationships between volumes, subvolumes, plexes, and volume elements in an XLV logical volume. In this example, six physical disk drives contain eight disk partitions. The logical volume has a log subvolume, a data subvolume, and a real-time subvolume. The log subvolume has two plexes (copies of the data) for higher reliability, and the data and real-time subvolumes are not plexed (meaning that they each consist of a single plex). The log plexes each consist of a volume element, which is a disk partition on disk 1. The plex of the data subvolume consists of two volume elements, a partition that is the remainder of disk 1 and a partition that is all of disk 2. The plex used for the real-time subvolume is striped for increased performance. The striped volume element is constructed from four disk partitions, each of which is an entire disk.

The following subsections describe these logical storage objects in more detail.

## Volumes

Volumes are composed of subvolumes. All volumes must have a data subvolume. Two other subvolumes, the log subvolume and the real-time subvolume, are optional. For XFS filesystems, a volume consists of a data subvolume, an optional log subvolume, and an optional real-time subvolume. For EFS filesystems, a volume consists of just one subvolume, the data subvolume. (EFS filesystems are of a filesystem type supported in previous IRIX releases; they are described in Appendix A, “EFS Filesystems”.) The breakdown of a volume into subvolumes is shown in Figure 3-4.

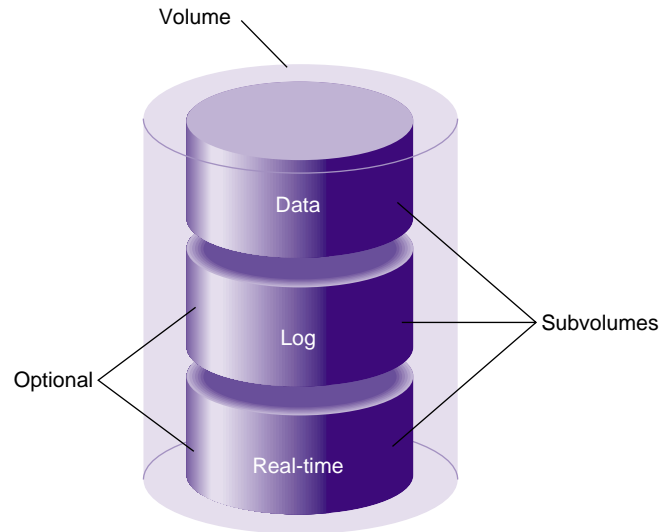
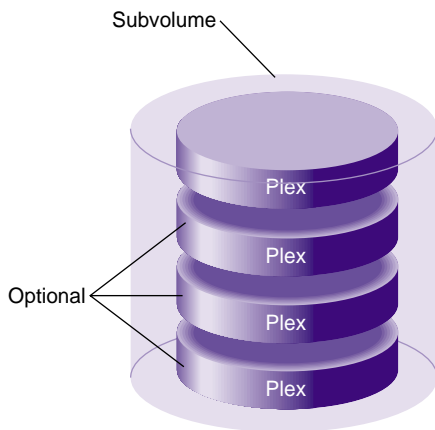

**Figure 3-4** Volume Composition

Each volume can be used as a single filesystem or as a raw partition. Volume information used by the system during system startup is stored in logical volume labels in the volume header of each disk used by the volume (see “Volume Headers” in Chapter 1). At system startup, volumes will not come online if any of their subvolumes cannot be brought online. You can create volumes, delete them, and move them to another system.

## Subvolumes

As explained in “Volumes” on page 56, each logical volume is composed of one to three subvolumes. A subvolume contains one to four plexes, as shown in Figure 3-5.



**Figure 3-5** Subvolume Composition

---

**Note:** The plexing feature of XLV, which enables the use of the optional plexes, is available only when you purchase the Disk Plexing Option software option.

---

Each subvolume is a distinct address space and a distinct type. The types of subvolumes are:

**Data subvolume**

The data subvolume is required in all XLV logical volumes. It is the only subvolume present in EFS filesystems. (EFS filesystems are of a filesystem type supported in previous IRIX releases; they are described in Appendix A, "EFS Filesystems".)

**Log subvolume**

The log subvolume contains XFS journaling information. It is a log of filesystem transactions and is used to expedite system recovery after a crash. Log information is sometimes put in the data subvolume rather than in a log subvolume (see "Choosing the Log Type and Size" in Chapter 6 and the `mkfs_xfs(1M)` reference page and its discussion of the `-l` option for more information).

### Real-time subvolume

Real-time subvolumes are generally used for data applications such as video, where guaranteed response time is more important than data integrity. Chapter 8, “System Administration for Guaranteed-Rate I/O,” explains how applications access data on real-time subvolumes.

Subvolumes enforce separation among data types. For example, user data cannot overwrite filesystem log data. Subvolumes also enable filesystem data and user data to be configured to meet goals for performance and reliability. For example, performance can be improved by putting subvolumes on different disk drives.

Each subvolume can be organized independently. For example, the log subvolume can be plexed for fault tolerance and the real-time subvolume can be striped across a large number of disks to give maximum throughput for video playback.

Volume elements that are part of a real-time subvolume should not be on the same disk as volume elements used for data or log subvolumes. This is a recommendation for all files on real-time subvolumes and required for files used for guaranteed-rate I/O with hard guarantees. (See “Hardware Configuration Requirements for GRIO” in Chapter 8 for more information.)

Once a subvolume is created, it cannot be detached from its volume or deleted without deleting its volume. Subvolumes are automatically deleted when their volumes are deleted.

## Plexes

A subvolume can contain from one to four *plexes* (also known as *mirrors*). Each plex is an exact replica of all or a portion of the subvolume’s data. By creating a subvolume with multiple plexes, system reliability is increased because there are redundant copies of the data.

If there is just one plex in a subvolume, that plex spans the entire address space of the subvolume. However, in the case of multiple plexes, individual plexes can have holes in their address spaces as long as the union of all plexes spans the entire address space. Figure 3-6 shows an example of this configuration. The subvolume contains three plexes. If complete, each plex would contain three volume elements. However, two of the plexes are missing a volume element. This is allowed because there is at least one volume element with each address range. In fact, if Plex 1 in the figure were detached (removed

from the subvolume), the subvolume would still be functional because there is still at least one volume element with each address range.

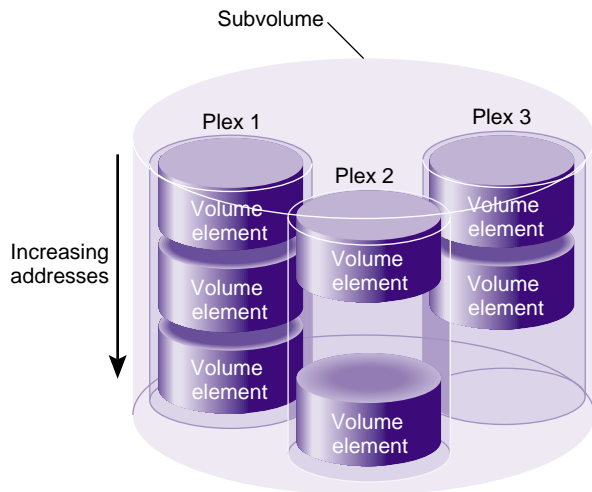
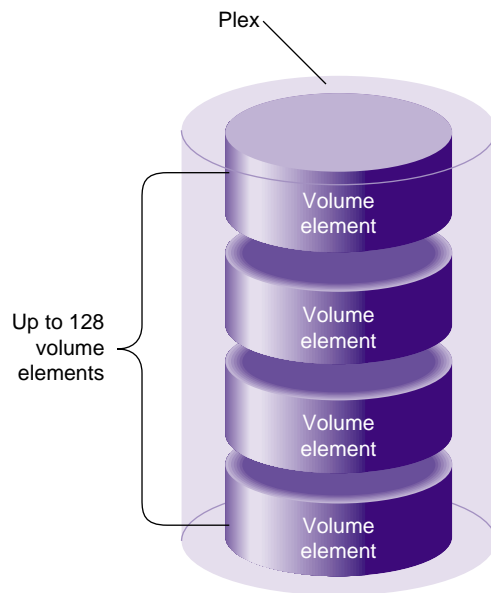

**Figure 3-6** Plexed Subvolume Example

Data is written to all plexes. When an additional plex is added to a subvolume, the entire plex is copied (this is called a *plex revive*) automatically by the system. See the `xlv_assemble(1M)` and `xlv_plexd(1M)` reference pages for more information.

A plex is composed of one or more volume elements, as shown in Figure 3-7, up to a maximum of 128 volume elements. Each volume element represents a range of addresses within the subvolume.





**Figure 3-7** Plex Composition

When a plex is composed of two or more volume elements, it is said to have *concatenated* volume elements. With concatenation, data written sequentially to the plex is also written sequentially to the volume elements; the first volume element is filled, then the second, and so on. Concatenation is useful for creating a filesystem that is larger than the size of a single disk.

You can add plexes to subvolumes, detach them from subvolumes that have multiple plexes (and possibly attach them elsewhere), and delete them from subvolumes that have multiple plexes.

---

**Note:** To have multiple plexes, you must purchase the Disk Plexing Option software option and obtain and install a FLEXlm license.

---

## Volume Elements

Volume elements are the lowest level in the hierarchy of logical storage objects: volumes are composed of subvolumes; subvolumes are composed of plexes; and plexes are composed of volume elements. Volume elements are composed of physical storage elements: disk partitions. They are composed of one or more disk partitions with or without striping (at least two disk partitions are required for striping). Any mixture of the three types of volume elements (single partition, striped, and multipartition) can be included in a plex.

### Single-Partition Volume Elements

The simplest type of volume element is a single disk partition. The two other types of volume elements, striped volume elements and multipartition volume elements, are composed of several disk partitions. Figure 3-8 shows a single partition volume element.

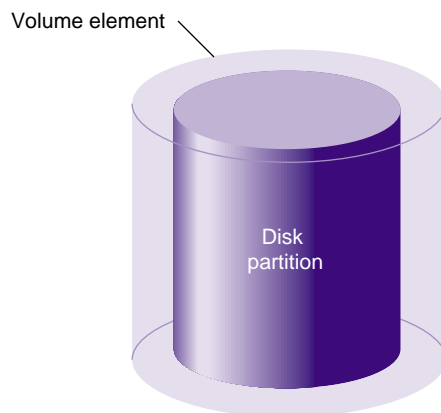

**Figure 3-8** Single-Partition Volume Element Composition

## Striped Volume Elements

Figure 3-9 shows a striped volume element. Striped volume elements consist of two or more disk partitions, organized so that an amount of data called the stripe unit is written to each disk partition before writing the next stripe unit-worth of data to the next partition.

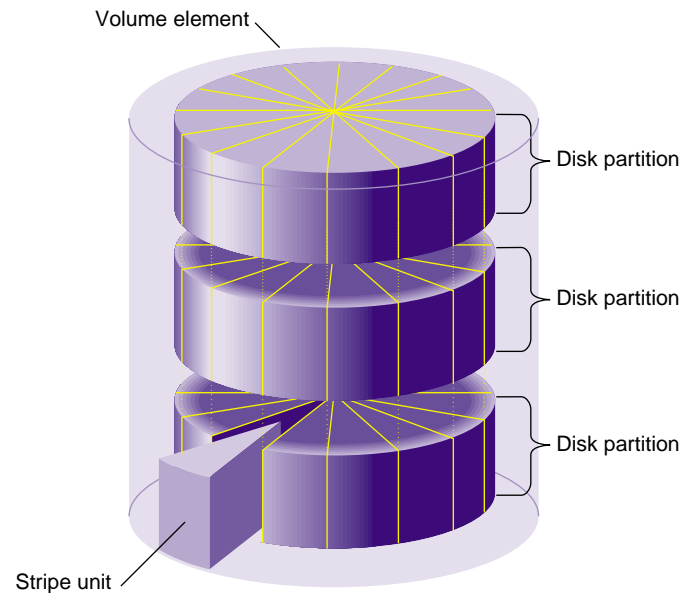

**Figure 3-9** Striped Volume Element Composition

Striping can be used to alternate sections of data among multiple disks. This provides a performance advantage by allowing parallel I/O activity. You can use these rules of thumb as a starting point for choosing a stripe unit size:

- The stripe unit size should be a function of the I/O size of the application that uses the striped volume and the number of partitions in the stripe: the stripe unit size should be the application I/O size divided by the number of partitions. This keeps all disks busy all of the time, which is ideal.
- The default stripe unit is the device track size, which is a good value to use, particularly when there are more reads than writes to the disk.

- Stripe unit sizes of less than 64 KB are not recommended.
- For best write performance, the stripe unit size should be several tracks. However, large stripe unit sizes require larger I/O buffer sizes, which can be a problem.
- In choosing the optimal stripe unit size, balance the benefits of parallel I/O activity, the efficiency of I/O to a single disk drive (larger reads and writes have less overhead), and the limits on I/O buffer size.

### Multipartition Volume Elements

Figure 3-10 shows a multipartition volume element in which the volume element is composed of more than one disk partition. In this configuration, the disk partitions are addressed sequentially.

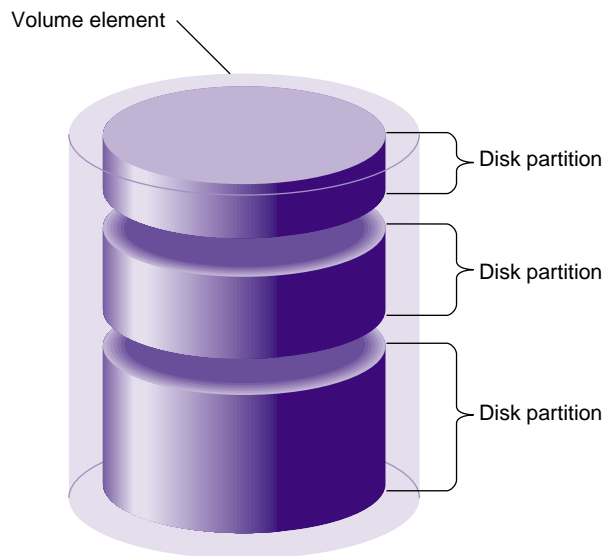

**Figure 3-10** Multipartition Volume Element Composition

## XLV Logical Volume Names

Volumes appear as block and character devices in the `/dev` directory. The device names for XLV logical volumes are `/dev/xlv/volume_name` and `/dev/rxlv/volume_name`, where *volume\_name* is a volume name specified when the volume is created using the `xlv_make` command. The volume name and plex, subvolume, and volume element names specified while using the `xlv_make` command cannot contain periods (.).

---

**Note:** In IRIX 6.2 and IRIX 5.3 with XFS, XLV logical volume device files had the names `/dev/dsk/xlv/volname` and `/dev/rdsk/xlv/volname`.

---

When a volume is created on one system and moved (by moving the disks) to another system, the new volume name is the same as the original volume name with the hostname of the original system prepended. For example, if a volume called `xlv0` is moved from a system called `engr1ab1` to a system called `engr1ab2`, the device name of the volume on the new system is `/dev/xlv/engr1ab1.xlv0` (the old system name `engr1ab1` has been prepended to the volume name `xlv0`).

## XLV Daemons

The XLV daemons are:

|                        |   |
|------------------------|---|
| <code>xlv_labd</code>  | <code>xlv_labd</code> updates XLV logical volume labels. It is started automatically at system startup if it is installed and there are active XLV logical volumes.   |
| <code>xlv_d</code>     | <code>xlv_d</code> performs I/O operations to plexes during plex error recovery. It is created automatically during system startup if plexing software is installed and there are active XLV logical volumes. |
| <code>xlv_plexd</code> | <code>xlv_plexd</code> is responsible for making all plexes within a subvolume have the same data. It is started automatically at system startup if there are active XLV logical volumes.                     |

XLV does not require an explicit configuration file, nor is it turned on and off with the `chkconfig` command. XLV is able to assemble logical volumes based solely upon information written in the logical volume labels. During initialization, the system performs a hardware inventory, reads all the logical volume labels, and automatically assembles the available disks into previously defined volumes.

If some disks are missing, XLV checks whether there are enough volume elements among the available plexes to map the entire address space. If the whole address space is available, XLV brings the volume online even if some of the plexes are incomplete.

## XLV Error Policy

For read failures on log and data subvolumes, XLV rereads from a different plex (when available) and attempts to fix the failed plex by rewriting the results. XLV does not retry on failures for real-time data.

For write errors on log and data subvolumes, XLV assumes that these write errors are hard errors (the disk driver and controllers handle soft errors). If the volume element with a hard error is plexed, XLV marks the volume element offline and ignores the volume element from then on. If the volume element is not plexed, the volume element remains associated with the volume and an error is returned.

XLV does not handle write errors on real-time subvolumes. Incorrect data is returned without error messages on subsequent reads.

## XLV Logical Volume Planning

The following subsections discuss topics to consider when planning an XLV logical volume.

### When to Avoid Using XLV

In some situations where XLV logical volumes cannot be used or are not recommended:

- Raw swap devices cannot be XLV logical volumes. (However, swap space can be added as a regular file in a filesystem and that filesystem could be on an XLV logical volume. See the chapter “Configuring Disk and Swap Space” in the *IRIX Admin: System Configuration and Operation* guide for more information.)
- XLV logical volumes are not recommended on systems with a single disk.
- Striped or concatenated XLV volumes cannot be used for the root filesystem.

## Selecting Subvolumes

Follow these basic guidelines for choosing which subvolumes to use with XFS filesystems:

- Data subvolumes are required.
- Log subvolumes are optional. If they are not used, log information is put into an internal log in the data subvolume. In most cases, there is no advantage to using an external log.
- Real-time subvolumes are optional.

When you want a large raw partition with no filesystem on it, only the data subvolume is used.

When you create a logical volume with a real-time subvolume, it must also include a data subvolume.

Follow these basic guidelines for choosing which subvolumes to use with EFS filesystems. (EFS filesystems are of a filesystem type supported in previous IRIX releases; they are described in Appendix A, “EFS Filesystems”.)

- Only data subvolumes can be used.
- The maximum size of an EFS filesystem is 8 GB; do not make the data subvolume bigger than that or the space is wasted.

## Choosing Subvolume Sizes

Use these basic guidelines for choosing subvolume sizes:

- The maximum size of a subvolume is one terabyte on 32-bit systems (IP17, IP20, IP22, and IP32). It is unlimited on 64-bit systems (IP19, IP21, IP25, IP26, and IP27).
- Choosing the size of the log (and therefore the size of the log subvolume) is discussed in “Choosing the Log Type and Size” in Chapter 6. Note that if you do not intend to repartition a disk to create an optimal-size log partition, your choice of an available disk partition may determine the size of the log.

## Choosing Whether To Plex

The basic guidelines for plexing are:

- Use plexing when high reliability and high availability of data are required.
- The root filesystem can be plexed; each plex must be a single partition volume element.
- Dual-hosted XLV logical volumes (logical volume on disks that are connected to two systems) cannot be plexed.
- RAID disks should not be plexed.
- Plexes can have “holes” in them, portions of the address range not contained by a volume element, as long as at least one of the plexes in the subvolume has a volume element with the address range of the hole.
- The volume elements in each plex of a subvolume must be identical in size with their counterparts in other plexes (volume elements with the same address range). The structure within a volume element (single partition, striped, or multipartition) does not have to match the structure within its counterparts.
- To make volume elements identical in size, use the `fx` command in expert mode (`fx -x`). At the first `fx` menu, give the command `repartition/expert -b`. This enables you to repartition in units of blocks, which ensures that the volume element is the exact size you want it.

## Choosing Whether To Stripe

The basic guidelines for striping are:

- The root filesystem cannot be striped.
- Striped I/O can be used with both direct and buffered I/O. Whether to stripe or not to stripe depends on the access patterns of the data. In general, striped performance is better than non-striped performance.
- Striped disks lead to performance improvement only when the applications that use them make large data transfers that access all disks in the stripe in the filesystem.
- Striped volume elements should be made of disk partitions that are exactly the same size. When the disk partitions are different sizes, the smallest size is used. Additional space in the larger partitions is wasted.



- For best performance, each disk involved in a striped volume element should be on a separate controller. For some disk types, performance improvement is seen with up to four disks per controller. For other disk types, no additional performance improvement is seen with three or more disks.
- A log subvolume can be striped only if it is an external log. Striping a log does not result in a performance improvement.

## Choosing Whether to Concatenate Disk Partitions

The basic guidelines for the concatenation of disk partitions are:

- The root filesystem cannot have concatenated disk partitions.
- It is better to concatenate single-partition volume elements into a plex rather than to create a single multipartition volume element. This is not for performance reasons, but for reliability. When one disk partition goes bad in a multipartition volume element, the whole volume element is taken offline.



## Creating and Administering XLV Logical Volumes

This chapter describes the procedures for creating and administering XLV logical volumes using command-line utilities. A graphical user interface for performing many of these procedures is available from the `xlv` command. See its online help for more information about `xlv`.

---

**Note:** For information on XVM logical volume management, see the *XVM Volume Manager Administrator's Guide*.

---

The major sections in this chapter are:

- “Verifying That Plexing Is Supported” on page 72
- “Creating Volume Objects With `xlv_make`” on page 72
- “Displaying XLV Logical Volume Objects” on page 79
- “Adding a Volume Element to a Plex (Growing an XLV Logical Volume)” on page 80
- “Adding a Plex to an XLV Logical Volume” on page 82
- “Detaching a Plex From an XLV Logical Volume” on page 84
- “Deleting an XLV Object” on page 85
- “Removing and Mounting a Plex” on page 86
- “Replacing a Disk For a Plexed Volume” on page 89
- “Creating a Plexed XLV Logical Volume for Root” on page 92
- “Booting the System Off an Alternate Plex” on page 95
- “Configuring the System for More Than Ten XLV Logical Volumes” on page 97
- “Converting lv Logical Volumes to XLV Logical Volumes” on page 97
- “Creating a Record of XLV Logical Volume Configurations” on page 99

## Verifying That Plexing Is Supported

As discussed in Chapter 3, “XLV Logical Volume Concepts,” the plexing feature of XLV, which enables the use of multiple plexes, is available only when you purchase the Disk Plexing Option software option and install a FLEXlm license.

You can use the `xlv_mgr` command to verify that the plexing software and a valid license are installed. Follow these steps:

1. Invoke `xlv_mgr`:

```
# xlv_mgr
```

2. Use the `show config` command:

```
xlv_mgr> show config
Allocated subvol locks: 30      locks in use: 6
Plexing license: present
Plexing support: present
Maximum subvol block number: 0x7fffffffffffffff
```

The second and third lines of output, “Plexing license: present” and “Plexing support: present,” indicate that plexing software is installed with a valid license.

3. Quit out of `xlv_mgr`:

```
xlv_mgr> quit
```

## Creating Volume Objects With `xlv_make`

The `xlv_make` command creates volumes, subvolumes, plexes, and volume elements from unused disk partitions. It writes the XLV logical volume labels in the disk volume headers only; data on the disk partitions is untouched.

After you create a volume, make a filesystem on it if necessary, and mount the filesystem so that you can use the XLV logical volume.

---

**Caution:** When you make the filesystem using `mkfs`, all data already on the disk partitions is destroyed.

---

`xlvmake` can be run interactively or it can take commands from an input file. The remainder of this section gives two examples of using `xlvmake`; the first one is interactive and the second is noninteractive.

## Example 1: Creating A Simple XLV Logical Volume

This example creates a simple XLV logical volume composed of a data subvolume created from two entire option disks. The disks are on controller 0, drive addresses 2 and 3. An XFS filesystem is created and mounted at `/vol11`.

1. Unmount the disks that will be used in the volume if they are mounted. For example:

```
# df
Filesystem                Type      blocks   use  avail %use  Mounted on
/dev/root                  efs      1939714  430115 1509599  22%  /
/dev/dsk/dks0d2s7         efs      2004550    22 2004528   0%  /d2
/dev/dsk/dks0d3s7         efs      3826812    22 3826790   0%  /d3
# umount /d2
# umount /d3
```

2. Start `xlvmake`:

```
# xlvmake
xlvmake>
```

3. Start creating the volume by specifying its name, for example `xlV0`:

```
xlvmake> vol xlV0
xlV0
```

4. Begin creating the data subvolume:

```
xlvmake> data
xlV0.data
```

`xlvmake` echoes the name of each object (volume, subvolume, plex, or volume element) you create.

5. Continue to move down through the hierarchy of the volume by specifying the plex:

```
xlvmake> plex
xlV0.data.0
```

- Specify the volume elements (disk partitions) to be included in the volume, for example `/dev/dsk/dks0d2s7` and `/dev/dsk/dks0d3s7`:

```
xlvmake> ve dks0d2s7
xlvmake> ve dks0d3s7
xlvmake> ve dks0d2s7
xlvmake> ve dks0d3s7
```

You can specify the last portion of the disk partition pathname (as shown) or the full pathname. `xlvmake` accepts disk partitions that are of types `xlvm`, `xfss`, and `efss`. You can use other partition types, such as `lvol`, by specifying the `-force` option; for example, `ve -force dks0d2s7`. `xlvmake` automatically changes the partition type to `xlvm`.

- Indicate that you are finished specifying the objects:

```
xlvmake> end
Object specification completed
```

- Review the objects that you specified:

```
xlvmake> show

Completed Objects
(1) VOL xlvm0
VE xlvm0.data.0.0 [empty]
    start=0, end=2004549, (cat)grp_size=1
    /dev/dsk/dks0d2s7 (2004550 blks)
VE xlvm0.data.0.1 [empty]
    start=2004550, end=5831361, (cat)grp_size=1
    /dev/dsk/dks0d3s7 (3826812 blks)
```

This output shows one volume with two volume elements. The size of each partition used is shown, for example, 2004550 blocks. These blocks are disk blocks and are 512 bytes.

- Write the volume information to the logical volume labels by exiting `xlvmake`:

```
xlvmake> exit
Newly created objects will be written to disk.
Is this what you want?(yes) yes
Invoking xlvm_assemble
```

10. Make an XFS filesystem using `mkfs`. For example:

```
# mkfs /dev/xlv/xlv0
meta-data=/dev/xlv/xlv0          isize=256    agcount=8, agsize=16094 blks
data      =                      bsize=4096  blocks=2482901
log       =internal log         bsize=4096  blocks=1000
realtime  =none                  bsize=4096  blocks=0, rtextents=0
```

11. Mount the filesystem, for example:

```
# mkdir /vol1
# mount /dev/xlv/xlv0 /vol1
```

12. To have the logical volume mounted automatically at system startup, add an entry for the volume to `/etc/fstab`. For example:

```
/dev/xlv/xlv0 /vol1 xfs rw,raw=/dev/rxlv/xlv0 0 0
```

## Example 2: Creating A Striped, Plexed XLV Logical Volume

This example shows the noninteractive creation of an XLV logical volume from four equal-sized option disks (controller 0, units 2 through 5). Two plexes will be created with the data striped across the two disks in each plex. The stripe unit will be 128 KB. An XFS filesystem is created and mounted at `/vol1`.

1. As in the previous example, unmount filesystems on the disks to be used, if necessary.
2. Create a file called `xlv0.specs` that contains input for `xlvmake`. For this example and a volume named `xlv0`, the file contains:

```
vol xlv0
data
plex
ve -stripe -stripe_unit 256 dks0d2s7 dks0d3s7
plex
ve -stripe -stripe_unit 256 dks0d4s7 dks0d5s7
end
show
exit
```

This script specifies the volume hierarchically: volume, subvolume (data), first plex with a striped volume element, then second plex with a striped volume element. The `ve` commands have a stripe unit argument of 256. This argument is the number of 512-byte disk blocks (sectors), so  $128\text{ KB}/512 = 256$ . The `end` command signifies

that the specification is complete and the (optional) `show` command causes the specification to be displayed. The logical volume label is created by the `exit` command.

3. Run `xlv_make` to create the volume. For example:

```
# xlv_make xlv0.specs
```

4. Make an XFS filesystem with an internal 10 MB log and 1 KB block size:

```
# mkfs -b size=1k -l size=10m /dev/xlv/xlv0
```

5. Mount the filesystem, for example:

```
# mkdir /vol1  
# mount /dev/xlv/xlv0 /vol1
```

6. To have the logical volume mounted automatically at system startup, add an entry for the volume to `/etc/fstab`, for example:

```
/dev/xlv/xlv0 /vol1 xfs rw,raw=/dev/rxlv/xlv0 0 0
```

### Example 3: Creating A Plexed XLV Logical Volume for an XFS Filesystem With an External Log

The following example shows how to create an XLV logical volume with a log subvolume that is plexed and a data subvolume that is concatenated and plexed. The volume will be used to hold an XFS filesystem with an external log.

This example uses four disks on controller 1 at drive addresses 2 through 5. The disks at drive addresses 2 and 3 are partitioned as option drives with `xfslog` partitions. The disks at drive addresses 4 and 5 are partitioned as option drives without `xfslog` partitions.



1. Invoke `xlV_make` and begin to create the volume, called `xfS-mp5`, by creating the log subvolume with two plexes:

```
# xlv_make
xlV_make> vol xfS-mp5
xfS-mp5
xlV_make> log
xfS-mp5.log
xlV_make> plex
xfS-mp5.log.0
xlV_make> ve dks1d2s15
xfS-mp5.log.0.0
xlV_make> plex
xfS-mp5.log.1
xlV_make> ve dks1d3s15
xfS-mp5.log.1.0
```

2. Create the data subvolume with two plexes, each of which has two volume elements:

```
xlV_make> data
xfS-mp5.data
xlV_make> plex
xfS-mp5.data.0
xlV_make> ve dks1d2s7
xfS-mp5.data.0.0
xlV_make> ve dks1d4s7
xfS-mp5.data.0.1
xlV_make> plex
xfS-mp5.data.1
xlV_make> ve dks1d3s7
xfS-mp5.data.1.0
xlV_make> ve dks1d5s7
xfS-mp5.data.1.1
```

3. Indicate that you have completed the volume, display it, and exit `xlvmake`:

```

xlvmake> end
Object specification completed
xlvmake> show

          Completed Objects
(1) VOL xfs-mp5
VE xfs-mp5.log.0.0 [empty]
    start=0, end=8255, (cat)grp_size=1
    /dev/dsk/dks1d2s15 (8256 blks)
VE xfs-mp5.log.1.0 [empty]
    start=0, end=8255, (cat)grp_size=1
    /dev/dsk/dks1d3s15 (8256 blks)
VE xfs-mp5.data.0.0 [empty]
    start=0, end=3920223, (cat)grp_size=1
    /dev/dsk/dks1d2s7 (3920224 blks)
VE xfs-mp5.data.0.1 [empty]
    start=3920224, end=7848703, (cat)grp_size=1
    /dev/dsk/dks1d4s7 (3928480 blks)
VE xfs-mp5.data.1.0 [empty]
    start=0, end=3920223, (cat)grp_size=1
    /dev/dsk/dks1d3s7 (3920224 blks)
VE xfs-mp5.data.1.1 [empty]
    start=3920224, end=7848703, (cat)grp_size=1
    /dev/dsk/dks1d5s7 (3928480 blks)

xlvmake> exit
Newly created objects will be written to disk.
Is this what you want?(yes) y
Invoking xlv_assemble

```

4. Make an XFS filesystem by running `mkfs`. Note how `mkfs` automatically uses an external log when one is present.

```

# mkfs /dev/xlv/xfs-mp5
meta-data=/dev/xlv/xfs-mp5  isize=256   agcount=8, agsize=122636 blks
data      =                   bsize=4096  blocks=981088
log       =volume log        bsize=4096  blocks=1032
realtime  =none              bsize=65536 blocks=0, rtextents=0

```

5. Mount the filesystem, for example:

```

# mkdir /v1
# mount /dev/xlv/xfs-mp5 /v1

```

6. To have the logical volume mounted automatically at system startup, add an entry for the volume to `/etc/fstab`, for example:

```
/dev/xlv/xfs-mp5 /v1 xfs rw,raw=/dev/rxlv/xfs-mp5 0 0
```

## Displaying XLV Logical Volume Objects

To get a list of the top level XLV objects on a system (volumes, unattached plexes, and unattached volume elements), invoke `xlv_mgr` and invoke the command `show all`, for example:

```
# xlv_mgr
xlv_mgr> show all
Volume Element: SPARE_VE
Volume:          BIG_VOLUME (complete)
```

In this example, there are two top level objects, a volume element named `SPARE_VE` and an XLV logical volume named `BIG_VOLUME`. The volume element is a top level object because it is not part of (attached to) any plex. Volume elements can be attached to a plex at a later time.

To display the complete hierarchy of a top level object, invoke the `xlvmgr` command `show object` with the name of the object, for example:

```
xlvmgr> show object BIG_VOLUME
VOL BIG_VOLUME (complete)
VE BIG_VOLUME.log.0.0 [active]
    start=0, end=8255, (cat)grp_size=1
    /dev/dsk/dks1d2s15 (8256 blks)
VE BIG_VOLUME.log.1.0 [active]
    start=0, end=8255, (cat)grp_size=1
    /dev/dsk/dks1d3s15 (8256 blks)
VE BIG_VOLUME.log.2.0 [active]
    start=0, end=8255, (cat)grp_size=1
    /dev/dsk/dks1d4s15 (8256 blks)
VE BIG_VOLUME.data.0.0 [active]
    start=0, end=3920223, (cat)grp_size=1
    /dev/dsk/dks1d2s7 (3920224 blks)
VE BIG_VOLUME.data.1.0 [active]
    start=0, end=3920223, (cat)grp_size=1
    /dev/dsk/dks1d3s7 (3920224 blks)
VE BIG_VOLUME.data.2.0 [active]
    start=0, end=3920223, (cat)grp_size=1
    /dev/dsk/dks1d4s7 (3920224 blks)
```

This output shows that `BIG_VOLUME` contains log and data subvolumes. Each subvolume has three plexes that have one volume element each.

### Adding a Volume Element to a Plex (Growing an XLV Logical Volume)

Growing an XLV logical volume (increasing its size) can be done by adding one or more volume elements to the end of one or more of its plexes. (If you do not add volume elements to all plexes, data stored in the added volume elements won't be replicated in all plexes.)

The following procedure assumes that you are starting with an XLV logical volume. If you are starting with a filesystem on a single disk partition that you want to turn into a logical volume and grow onto an additional disk partition, use the procedure in "Growing an XFS Filesystem Onto Another Disk" in Chapter 6 instead.

1. If any of the volume elements you plan to add to the volume don't exist yet, create them with `xlvmake`. For example, follow this procedure to create a volume element out of a new disk, `/dev/dsk/dks0d4s7`:

```
# xlvmake
xlvmake> ve spare_ve dks0d4s7
new_ve
xlvmake> end
Object specification completed
xlvmake> exit
Newly created objects will be written to disk.
Is this what you want?(yes) yes
Invoking xlvassemble
```

The `ve` command creates a volume element name, `spare_ve`. The name is required because the volume element is not part of a larger hierarchy; it is the top level object in this case.

2. Use the `attach` command of the `xlvmgr` command to add each volume element. For example, to add the volume element from step 1 to plex 0 of the data subvolume of the volume `xlvm0`, use this procedure:

```
# xlvmgr
xlvmgr> attach ve spare_ve xlvm0.data.0
```

3. Quit out of `xlvmgr`:

```
xlvmgr> quit
```

4. If you are growing an XFS filesystem, mount the filesystem if it is not already mounted:

```
# mount volume mountpoint
```

*volume* is the device name of the logical volume, for example `/dev/xlv/xlv0`, and *mountpoint* is the mount point directory for the logical volume.

5. If you are growing an XFS filesystem, use `xfs_growfs` to grow the filesystem:

```
# xfs_growfs -d mountpoint
```

*mountpoint* is the mount point directory for the logical volume.

6. If you are growing an EFS filesystem, unmount the filesystem if it is mounted, and use `growfs` to grow the filesystem:

```
# umount mountpoint
# growfs volume
```

*mountpoint* is the mount point directory for the filesystem. *volume* is the device name of the logical volume, for example, `/dev/xlv/xlv0`.

## Adding a Plex to an XLV Logical Volume

If you have purchased the Disk Plexing Option software option and have installed a FLEXlm license for it, you can add a plex to an existing subvolume for improved reliability in case of disk failures. The procedure to add a plex to a subvolume is described below. To add more than one plex to a subvolume or to add a plex to each of the subvolumes in a volume, repeat the procedure as necessary.

1. If the plex that you want to add to the subvolume does not exist yet, create it with `xlv_make`. For example, to create a plex called `plex1` to add to the data subvolume of a volume called `root_vol`, enter these commands:

```
# xlv_make
xlv_make> plex plex1
plex1
xlv_make> ve /dev/dsk/dks0d3s7
plex1.0
xlv_make> end
Object specification completed
xlv_make> exit
Newly created objects will be written to disk.
Is this what you want?(yes) yes
Invoking xlv_assemble
```

2. Use the `xlv_mgr` command to add the plex to the volume. For example, to add the standalone plex `plex1` to `root_vol`, use this procedure:

```
# xlv_mgr
xlv_mgr> attach plex plex1 root_vol.data
```

`xlv_mgr` automatically initiates a plex revive operation to copy the contents of the original plex, `root_vol.data.0`, to the newly added plex.

3. You can confirm that `root_vol` now has two plexes by displaying the object hierarchy:

```

xlv_mgr> show object root_vol
VOL root_vol (complete)
VE root_vol.data.0.0 [active]
    start=0, end=988091, (cat)grp_size=1
    /dev/dsk/dks0d2s7 (988092 blks)
VE root_vol.data.1.0 [empty]
    start=0, end=988091, (cat)grp_size=1
    /dev/dsk/dks0d3s7 (988092 blks)

```

The newly added plex, `root_vol.data.1`, is initially in the “empty” state. This is because it is newly created.

4. Exit `xlv_mgr`:

```
xlv_mgr> quit
```

The plex revive completes and the new plex switches to “active” state automatically, but if you want to check its progress and verify that the plex has become active, follow this procedure:

1. List the XLV daemons running, for example:

```

# ps -ef | grep xlv
root    27      1  0 10:49:27 ?        0:00 /sbin/xlv_plexd -m 4
root    35      1  0 10:49:28 ?        0:00 /sbin/xlv_labd
root    31      1  0 10:49:27 ?        0:00 xlvd
root    407     27  1 11:01:01 ?        0:00 xlv_plexd -v 2 -n root_vol.data
-d 50331648 -b 128 -w 0 0 1992629
root    410    397  2 11:01:11 pts/0    0:00 grep xlv

```

One instance of the `xlv_plexd` daemon is currently reviving `root_vol.data`. This daemon exits when the plex has been fully revived.

2. Later, check the XLV daemons again, for example:

```

# ps -ef | grep xlv
root    27      1  0 10:49:27 ?        0:00 /sbin/xlv_plexd -m 4
root    35      1  0 10:49:28 ?        0:00 /sbin/xlv_labd
root    31      1  0 10:49:27 ?        0:03 xlvd
root    459    397  2 11:21:10 pts/0    0:00 grep xlv

```

The instance of `xlv_plexd` that was reviving `root_vol.data` is no longer running; it has completed the plex revive.

3. Check the state of the plex using `xlv_mgr`:

```
# xlv_mgr
xlv_mgr> show object root_vol
VOL root_vol (complete)
VE root_vol.data.0.0      [active]
    start=0, end=988091, (cat)grp_size=1
    /dev/dsk/dks0d2s7 (988092 blks)
VE root_vol.data.1.0      [active]
    start=0, end=988091, (cat)grp_size=1
    /dev/dsk/dks0d2s0 (988092 blks)
xlv_mgr> quit
```

Both plexes are now in the “active” state.

## Detaching a Plex From an XLV Logical Volume

Detaching a plex from a volume, perhaps because you want to swap disk drives, can be done while the volume is active. However, the entire address range of the subvolume must still be covered by active volume elements in the remaining plex or plexes.

`xlv_mgr` does not allow you to detach the only active plex in a volume if the other plexes are not yet active. To detach a plex, follow these steps:

1. Start `xlv_mgr` and display the volume that has the plex that you plan to detach, for example, `root_vol`:

```
# xlv_mgr
xlv_mgr> show object root
VOL root (complete)
VE root.data.0.0          [active]
    start=0, end=1843199, (cat)grp_size=1
    /dev/dsk/dks1d3s0 (1843200 blks)
VE root.data.1.0          [active]
    start=0, end=1843199, (cat)grp_size=1
    /dev/dsk/dks1d4s0 (1843200 blks)
```

2. Detach plex 1 and give it the name `rplex1` by issuing these commands:

```
xlv_mgr> detach plex root.data.1 rplex1
```



3. To examine the volume and the detached plex, issue these commands:

```

xlv_mgr> show -long all
PLEX rplex1
VE rplex1.0      [stale]
    start=0, end=1843199, (cat)grp_size=1
    /dev/dsk/dks1d4s0 (1843200 blks)

VOL root (complete)
VE root.data.0.0 [active]
    start=0, end=1843199, (cat)grp_size=1
    /dev/dsk/dks1d3s0 (1843200 blks)

```

4. Exit xlv\_mgr:

```
xlv_mgr> quit
```

## Deleting an XLV Object

---

**Caution:** The procedures in this section can result in the loss of data if they are not performed properly. It is recommended for experienced IRIX system administrators only.

---

To delete a volume or any other XLV object, follow these steps:

1. If you are deleting a volume, you must unmount it first. For example:

```
# umount /vol1
```

2. Start xlv\_mgr and list each object on the system:

```

# xlv_mgr
xlv_mgr> show -long all
VOL root_vol (complete)
VE root_vol.data.0.0 [active]
    start=0, end=988091, (cat)grp_size=1
    /dev/dsk/dks0d2s0 (988092 blks)
VE root_vol.data.1.0 [active]
    start=0, end=988091, (cat)grp_size=1
    /dev/dsk/dks0d2s7 (988092 blks)

```

This example shows one high-level object, a volume with two plexes in a data subvolume (`root_vol.data.0` and `root_vol.data.1`). Each plex has one volume element.

3. If the element you want to delete is not a high-level object, you must first detach it from its high-level object. For example, to delete one of the plexes in the example, it must first be detached:

```
xlvmgr> detach plex root_vol.data.1 plex_to_be_deleted
```

Detached objects must be given a name, in this case `plex_to_be_deleted`.

4. Delete the object, in this example the plex `plex_to_be_deleted`:

```
xlvmgr> delete object plex_to_be_deleted
```

5. Confirm that the object is gone:

```
xlvmgr> show -long all
VOL root_vol (complete)
VE root_vol.data.0.0 [active]
    start=0, end=988091, (cat)grp_size=1
    /dev/dsk/dks0d2s0 (988092 blks)
```

6. Exit `xlvmgr`:

```
xlvmgr> quit
```

## Removing and Mounting a Plex

---

**Caution:** The procedure in this section can result in the loss of data if it is not performed properly. It is recommended only for experienced IRIX system administrators.

---

You can get a snapshot of a filesystem by removing a plex from a plexed volume and mounting that plex separately. Because you can only mount volumes, you must convert the plex into a volume. The following procedure shows you how to remove the plex from its original volume and make it into a separate volume:

1. Verify that the volume is currently not being revived. If there is a revive in progress, wait until the revive is done because the data among the plexes is not identical until after the plex revive is done.

```
# ps -ef | grep xlvp_plexd
root    35      1  0   Dec 13 ?           0:00 /sbin/xlv_plexd -m 4
```

The output shows that just one copy of `xlv_plexd`, the master process, is running. If more than one copy is running, a plex revive is in progress.

2. Unmount the filesystem mounted on the logical volume, `/projvol5` in this example:

```
# umount /projvol5
```

Unmounting the filesystem puts it into a clean state.

3. Start `xlvm_mgr` and display the logical volume, `xf5-mp5` in this example:

```
# xlvm_mgr
xlvm_mgr> show object xf5-mp5
VOL xf5-mp5 (complete)
VE xf5-mp5.log.0.0 [active]
    start=0, end=8255, (cat)grp_size=1
    /dev/dsk/dks1d2s15 (8256 blks)
VE xf5-mp5.log.1.0 [active]
    start=0, end=8255, (cat)grp_size=1
    /dev/dsk/dks1d3s15 (8256 blks)
VE xf5-mp5.data.0.0 [active]
    start=0, end=3920223, (cat)grp_size=1
    /dev/dsk/dks1d2s7 (3920224 blks)
VE xf5-mp5.data.0.1 [active]
    start=3920224, end=7848703, (cat)grp_size=1
    /dev/dsk/dks1d4s7 (3928480 blks)
VE xf5-mp5.data.1.0 [active]
    start=0, end=3920223, (cat)grp_size=1
    /dev/dsk/dks1d3s7 (3920224 blks)
VE xf5-mp5.data.1.1 [active]
    start=3920224, end=7848703, (cat)grp_size=1
    /dev/dsk/dks1d5s7 (3928480 blks)
```

4. Detach the second plex from the log subvolume and call it `log_copy`:

```
xlvm_mgr> detach plex xf5-mp5.log.1 log_copy
```

One of the plexes from the log subvolume must be detached because the volume that will be created with one of the data plexes must have a log subvolume to go with it.

5. Detach the second plex from the data subvolume and call it `data_copy`:

```
xlvm_mgr> detach plex xf5-mp5.data.1 data_copy
```

6. Display all of the high-level objects to verify that there are now one volume and two plexes:

```
xlvmgr> show all
Volume:          xfs-mp5 (complete)
Plex:            log_copy
Plex:            data_copy
```

7. Invoke the delete command for each detached plex:

```
xlvmgr> delete object log_copy
Object log_copy deleted.
```

```
xlvmgr> delete object data_copy
Object data_copy deleted.
```

The delete command changes the XLV logical volume information in the volume headers, but does not touch the data in the partitions.

8. Exit `xlvmgr`:

```
xlvmgr> quit
```

9. Make the partitions from the detached plexes into a volume:

```
# xlv_make
xlvmake> vol copy
copy
xlvmake> log
copy.log
xlvmake> ve dks1d3s15
copy.log.0.0
xlvmake> data
copy.data
xlvmake> ve dks1d3s7
copy.data.0.0
xlvmake> ve dks1d5s7
copy.data.0.1
xlvmake> end
Object specification completed
xlvmake> exit
Newly created objects will be written to disk.
Is this what you want?(yes) yes
Invoking xlv_assemble
```

10. Mount the new volume. The filesystem is still intact, so `mkfs` is not used (using `mkfs` would erase the data).

```
# mkdir /copy
# mount /dev/xlv/copy /copy
```

11. Remount the original filesystem:

```
# mount /dev/xlv/xfs-mp5 /projvol5
```

12. Use the `ls` command to confirm that the files on the original volume also appear on the new volume that you created from the removed plex.

```
# ls /copy
autoconfig  chroot      config      cron.d
chkconfig  clri        cron        fstab
# ls /projvol5
autoconfig  chroot      config      cron.d
chkconfig   clri        cron        fstab
```

## Replacing a Disk For a Plexed Volume

The procedure described in this section outlines the steps you must take when you find you need to replace a disk that contains a part of a plexed volume element.

---

**Note:** The example used is for a disk in an Origin Vault enclosure that is used for a plexed volume element. If you have a different disk setup, the XLV commands will be the same, although the specific procedures for physically replacing a disk will differ.

---

In summary, to replace a disk for a plexed volume, perform the following steps:

1. Remove the volume element with the broken disk from XLV
2. Physically replace the disk drive
3. Remake the XLV volume element using the new drive

These steps are detailed in the following sections.

## Remove the Volume Element From XLV

This example assumes an Origin Vault enclosure. In this example, the failed disk is drive ID 6 in Origin Vault 1 (dks2d6s7), which is in vol2 (plex 0). This example also assumes that there are two plexes, and that each plex has only a single volume element. The sample commands provided are for this specific disk failure example.

1. Delete the plex (or volume element) containing the broken disk from the volume (in this case vol2). This command sequence detaches the plex and renames it badplex.

```
# xlv_mgr
xlv_mgr> detach plex vol2.data.0 badplex
```

If the deletion is successful, go to “Physically Replace the Disk Drive” on page 91 and continue with the procedure described there. If the failed disk is unresponsive and the detachment fails, continue with step 2.

2. Execute the following commands. The `-force` option performs a detach operation when the parent object is missing any pieces.

```
xlv_mgr> detach -force plex vol2.data.0 badplex
xlv_mgr> delete object badplex
```

If the deletion is successful at this point, go to “Physically Replace the Disk Drive” on page 91 and continue with the procedure described there. If the failed disk is unresponsive and the detachment fails, continue with step 3.

3. Unmount the filesystem, killing processes that have open files.

```
# umount -k /fs2
```

4. Save the volume configuration, using the `-write` option of the `xlv_mgr script` command. You will need this information when you remake your volume, as described in step 6.

The `xlv_mgr script` command displays the `xlv_make(1M)` commands you need to create the volume. See the `xlv_mgr(1M)` man page for further information. The `-write` option saves the commands into the specified file location; you do not need to use this option if you record the command output yourself.

If `xlv_mgr` cannot read the XLV label off of the disk, the `script` command may not work. In this case, you will need to use the volume configuration information you saved as part of regular system backup and maintenance.

5. Delete the volume object:

```
xlv_mgr> delete object vol2
```

6. Remake the volume without the broken disk.

In this example, the volume `v2` was created with the following command sequence:

```
# xlv_make
xlv_make> vol2
xlv_make> data
xlv_make> plex
xlv_make> ve dks2d6s7
xlv_make> plex
xlv_make> ve dks3d6s7
xlv_make> end
xlv_make> exit
```

To remake the volume without the broken disk, execute the following command sequence:

```
# xlv_make
xlv_make> vol2
xlv_make> data
xlv_make> plex
xlv_make> ve dks3d6s7
xlv_make> end
xlv_make> exit
```

## Physically Replace the Disk Drive

Use the following procedure to replace the disk drive in an Origin Vault enclosure. You must turn the power off to be sure that the bus is quiet while you are replacing the disk. Inserting a disk while there is bus traffic can cause data corruption.

1. Identify the enclosure with the failed drive (Origin Vault 1 in this example).
2. Turn off power to Origin Vault 1.
3. Wait 10 seconds. This wait time is important, as it ensures the failed drive does not receive additional damage.
4. Physically remove the failed disk drive and install the replacement disk.
5. Power the Origin Vault 1 back on.

If I/O writes occur to `vol1` in Origin Vault 2 during the time that Origin Vault 1 is powered off, then `vol1` will need to be updated. Use `xlv_mgr` to determine if part of `vol1` is outdated or [offline] by entering the following command:

```
xlv_mgr> show kernel
```

If the output shows `[offline]`, the disk ID5 in Origin Vault 1 contains outdated data. If part of `vol1` is `[offline]`, use `xlvmgr` to put the affected volume element back on line.

In this example, drive `dks2d5s7` would have been `[offline]` due to the power outage. This drive is plex 0 of volume 1. Enter the command:

```
xlvmgr> change online vol1.data.0.0
```

You may also be able to use the warm-plug feature to replace the disk drive. This is true even if your disks are installed in the system cabinet rather than the Origin Vault enclosure described in this example. For information on this feature, see the `scsiadminswap(1M)`, `scsihotswap(1M)`, and the `scsiquiesce(1M)` man pages.

### Remake the XLV Volume Element Using the New Drive

Perform the following steps to provide the replacement drive with the XLV volume elements you are restoring.

1. Use the `fx(1M)` command to partition the new drive. It is essential that the new drive be repartitioned exactly as the failed drive.
2. Create a plex (volume element) on the new disk drive.

```
# xlvmake  
xlvmake> plex newplexname  
xlvmake> ve dks2d6s7
```

3. Attach the plex (or attach/insert the ve) back to the volume.

```
# xlvmgr  
xlvmgr> attach plex newplexname vol2.data
```

### Creating a Plexed XLV Logical Volume for Root

---

**Caution:** The procedure in this section can result in the loss of data if it is not performed properly. It is recommended only for experienced IRIX system administrators.

---

You can put your root filesystem on a plexed volume for greater reliability. A plexed root volume allows your system to continue running even if one of the root disks fails. If there is a separate `usr` filesystem on the system disk, it should be plexed, too. Because the



swap partition may be unavailable if the root disk fails, a spare swap partition should be available on a different disk. Administering the plexes of the root and, if present, `usr` volumes and the swap partitions, is easiest if each disk used in the volumes is identical and is partitioned identically.

The root volume can contain only a data subvolume. Each plex of the data subvolume can contain only a single volume element. The volume element must contain a single disk partition.

The root filesystem can be either an EFS filesystem or an XFS filesystem with an internal log.

Use the following procedure to create a plexed root volume. It assumes that you are starting with a working system (not a system with an empty system disk).

1. Make the root partition into an XLV volume. In this example, the XLV volume is called `xlvr_root`:

```
# xlvr_make
xlvr_make> vol xlvr_root
xlvr_root
xlvr_make> data
xlvr_root.data
xlvr_make> ve -force /dev/dsk/dks0d1s0
xlvr_root.data.0.0
xlvr_make> end
Object specification completed
xlvr_make> exit
Newly created objects will be written to disk.
Is this what you want?(yes) yes
Invoking xlvr_assemble
```

The result is an XLV volume named `xlvr_root` that contains the root partition. Because XLV preserves the data in partitions, the contents of the root partition are preserved. The `-force` option to the `ve` command was used because a mounted partition was included in the volume.

2. Reboot the system so that the system switches from running off the root partition at `/dev/dsk/dks0d1s0` to running off the logical volume `/dev/xlv/xlvr_root`:

```
# reboot
```

3. You can confirm that the root volume is being used by comparing the major and minor device numbers of `/dev/root` and `/dev/xlv/xlv_root`:

```
# ls -l /dev/root /dev/xlv/xlv_root
brw----- 2 root sys 192, 0 Oct 31 17:58 /dev/root
brw----- 2 root sys 192, 0 Dec 12 17:58 /dev/xlv/xlv_root
```

4. Create the second plex, for example, out of `/dev/dsk/dks0d2s0`, and call the plex `root_plex1`:

```
# xlv_make
xlv_make> plex root_plex1
root_plex1
xlv_make> ve /dev/dsk/dks0d2s0
root_plex1.0
xlv_make> end
Object specification completed
xlv_make> exit
Newly created objects will be written to disk.
Is this what you want?(yes) yes
Invoking xlv_assemble
```

5. Add `sash` to the volume header of the disk used for the second plex. It enables booting off of the alternate plex if the primary plex fails.

```
# dvhtool -v get sash /tmp/sash /dev/rdisk/dks0d1vh
# dvhtool -v add /tmp/sash sash /dev/rdisk/dks0d2vh
```

6. Attach the second plex to the volume using `xlv_mgr` and quit out of `xlv_mgr`:

```
# xlv_mgr
xlv_mgr> attach plex root_plex1 xlv_root.data
xlv_mgr> quit
```

When the shell prompt returns, the system automatically begins a plex revive so that the two plexes contain the same data.

## Booting the System Off an Alternate Plex

Once you plex the root volumes, you can boot off a secondary plex if the primary plex becomes unavailable. Because the boot PROM does not understand XLV logical volumes, you must manually reconfigure the system to boot the system from the disk that contains the alternate plex. The procedure for booting the system off a secondary plex depends on the model of workstation or server. The following subsection, “CHALLENGE L, CHALLENGE XL, and CHALLENGE DM” applies to those systems. For all other workstations and servers, including the Origin2000 server, follow the procedure in the subsection, “All Other Models” on page 96.

### CHALLENGE L, CHALLENGE XL, and CHALLENGE DM

With CHALLENGE L, XL, and DM systems, it is possible to change the drive addresses of disks using a dial or switch. If the system disk and the alternate disk are both internal disks on the same channel and are partitioned identically, you can swap the drive addresses of the two disks. (If the system does not meet these requirements, use the procedure in “All Other Models” on page 96 instead.) By exchanging the drive addresses for the system disk and the alternate disk, the system automatically boots off the alternate disk, which has become the new system disk. Follow this procedure:

1. Shut down the system. For example, use this command:  

```
# shutdown
```
2. Power off the system.
3. By manipulating the switches or dials on the system disk and the alternate disk, change each disk’s drive address to the other’s drive address.
4. Power up the system.

## All Other Models

The following procedure describes how to boot the system off the alternate root plex and can be used on all system. In the example used in this procedure, the system is reconfigured to boot off the partition `/dev/dsk/dks0d2s0` and use partition `/dev/dsk/dks0d2s1` as swap. Substitute the correct partitions for your system.

1. On the **System Maintenance** menu, choose `Enter Command Monitor`:

```
...
5) Enter Command Monitor

Option? 5
Command Monitor. Type "exit" to return to the menu.
```

2. Display the PROM environment variables:

```
>> printenv
SystemPartition=dksc(0,1,8)
OSLoadPartition=dksc(0,1,0)
root=dks0d1s0
...
```

The swap PROM environment variable (which is set below) is not displayed because it is not saved in NVRAM.

3. Reset the `SystemPartition`, `OSLoadPartition`, and `root` environment variables to have the values of the disk partition that contains the alternate plex and the swap environment variable to have the value of the alternate swap partition:

```
>> setenv SystemPartition dksc(0,2,8)
>> setenv OSLoadPartition dksc(0,2,0)
>> setenv root dks0d2s0
>> setenv swap /dev/dsk/dks0d2s1
```

4. Exit the **Command Monitor** and restart the system:

```
>> exit
...
Option? 1
Starting up the system...
...
```

## Configuring the System for More Than Ten XLV Logical Volumes

By default, a system can have up to ten XLV logical volumes. To increase the number of XLV logical volumes supported, you modify the file `/var/sysgen/master.d/xlv`. The procedure is:

1. Using any editor, open the file `/var/sysgen/master.d/xlv`, for example:

```
# vi /var/sysgen/master.d/xlv
```

2. Find this line in the file:

```
#define XLV_MAXVOLS 10
```

3. Change the 10 in this line to a higher number of your choice, for example:

```
#define XLV_MAXVOLS 20
```

4. Write the file and quit the editor.

5. Generate a new kernel:

```
# /etc/autoconfig
```

6. Reboot the system to make the change take effect:

```
# reboot
```

## Converting lv Logical Volumes to XLV Logical Volumes

This section explains the procedure for converting lv logical volumes to XLV logical volumes. The files on the logical volumes are not modified or dumped during the conversion. You must be superuser to perform this procedure.

1. Choose new names for the logical volumes, if desired. XLV, unlike lv, only requires names to be valid filenames (except periods are not allowed in XLV names), so you can choose more meaningful names. For example, you can make the volume names the same as the mount points you use. If you mount logical volumes at `/a`, `/b`, and `/c`, you can name the XLV volumes `a`, `b`, and `c`.
2. Unmount all lv logical volumes that you plan to convert to XLV logical volumes. For example:

```
# umount /a
```

3. Create an input script for `xlv_make` by using `lv_to_xlv`:

```
# lv_to_xlv -o scriptfile
```

*scriptfile* is the name of a temporary file that `lv_to_xlv` creates, for example `/usr/tmp/xlv.script`. It contains a series of `xlv_make` commands that can be used to create XLV volumes that are equivalent to the `lv` logical volumes listed in `/etc/lvtab`.

4. If you want to change the volume names, edit *scriptfile* and replace the names on the lines that begin with `vol` with the new names. For example, change:

```
vol lv0
```

```
to:
```

```
vol a
```

The volume name can be any name that is a valid filename.

5. By default, all `lv` logical volumes on the system are converted to XLV. If you do not want all `lv` logical volumes converted to XLV, edit *scriptfile* and remove the `xlv_make` commands for the volumes that you do not want to change. See “Creating Volume Objects With `xlv_make`” on page 72 and the `xlv_make(1M)` reference page for more information.
6. Create the XLV volumes by running `xlv_make` with *scriptfile* as input:

```
# xlv_make scriptfile
```

7. If you converted all `lv` logical volumes to XLV, remove `/etc/lvtab`:

```
# rm /etc/lvtab
```

If you converted only some of the `lv` logical volumes to XLV, open `/etc/lvtab` for editing to begin removing the entries for the logical volumes you converted.

```
# vi /etc/lvtab
```

8. Edit `/etc/fstab` so that it automatically mounts the XLV logical volumes at startup. These changes to `/etc/fstab` are required for each XLV logical volume:
  - In the first field, insert the subdirectory `xlv` after `/dev/dsk`.
  - If you changed the name of the volume, for example from `lv0` to `a`, make the change in the first field.
  - Insert the subdirectory `xlv` into the raw device name.
  - If you changed the name of the volume, for example from `lv0` to `a`, make the change in the raw device.

For example, if an original line is:

```
/dev/dsk/lv0 /a efs rw,raw=/dev/rdisk/lv0 0 0
```

the changed line, including the name change, is:

```
/dev/xlv/a /a efs rw,raw=/dev/rxlv/a 0 0
```

9. Mount the XLV logical volume, for example:

```
# mount /a
```

## Creating a Record of XLV Logical Volume Configurations

Information about XLV objects, volumes, subvolumes, plexes, and volume elements, is stored in logical volume labels in the volume header of each disk that contains an XLV object (see “Volume Headers” in Chapter 1 for more information). If an XLV logical volume label is removed, the system is unable to assemble the logical volume that includes that logical volume label, although the data in the object described in the logical volume label is still present. You can recreate the logical volume label with `xlv_make`, but only if you remember the exact configuration of the affected logical volume. The `xlv_mgr` command can be used to create a script that records the exact configuration of each logical volume on the system. This script can be given to `xlv_make` as input at a later time if it is ever necessary to recreate any XLV logical volumes on the system.

To create a record of the exact configuration of each XLV logical volume on the system, follow this procedure:

1. Start the `script` command, which begins capturing text on the screen, and put the captured text in the file `/var/config/XLV.configuration`:

```
# script /var/config/XLV.configuration  
Script started, file is XLV.configuration
```

2. Start `xlvmgr`:

```
# xlvmgr
```

3. Give the `script -write` command to `xlvmgr` with the name of a file that will contain the configuration information, for example `/var/config/XLV.configuration`:

```
xlvmgr> script -write /var/config/XLV.configuration
```

4. Exit `xlvmgr`:

```
xlvmgr> quit
```

5. Check the contents of the file that contains the configuration:

```
# cat /var/config/XLV.configuration  
#  
# Create Volume proj_vol  
#  
vol proj_vol  
data  
plex  
ve -force -start 0 /dev/dsk/dks1d3s11 /dev/dsk/dks1d3s12  
plex  
ve -force -start 0 /dev/dsk/dks1d6s2 /dev/dsk/dks1d6s3  
end  
exit
```



## Filesystem Concepts

This chapter explains some important concepts about hard disk *filesystems*, the structure by which files and directories are organized in the IRIX system. The chapter describes the primary type of IRIX filesystem, the XFS filesystem, and other disk filesystems. It explains concepts that are important to filesystem administration such as IRIX directory organization, filesystem features, filesystem types, creating filesystems, mounting and unmounting filesystems, and checking filesystems for consistency.

---

**Note:** For information on CXFS filesystems and the cluster environment they support, see the *CXFS Software Installation and Administration Guide*.

---

The major sections in this chapter are:

- “IRIX Directory Organization” on page 102
- “General Filesystem Concepts” on page 105
- “XFS Filesystems” on page 110
- “CXFS Filesystems” on page 112
- “EFS Filesystems” on page 113
- “Network File Systems (NFS)” on page 113
- “Cache File Systems (CacheFS)” on page 114
- “/proc Filesystem” on page 114
- “/hw Filesystem” on page 115
- “Foreign Filesystems” on page 118
- “XFS Filesystem Creation” on page 118
- “Filesystem Mounting and Unmounting” on page 119
- “XFS Filesystem Checking” on page 120
- “Filesystem Reorganization” on page 121

- “Filesystem Administration From the Miniroot” on page 121
- “How to Add Filesystem Space” on page 121
- “Disk Quotas” on page 123
- “Filesystem Corruption” on page 124

Even if you are familiar with the basic concepts of UNIX filesystems, you should read through the following sections. The IRIX XFS filesystem is slightly different internally from other UNIX filesystems and has slightly different administration commands and procedures.

Filesystem administration procedures are described in Chapter 6, “Creating and Growing Filesystems,” and Chapter 7, “Maintaining Filesystems.”

For information about floppy and CD-ROM filesystems, see the guide *IRIX Admin: Peripheral Devices*.

## IRIX Directory Organization

Every IRIX system disk contains some standard directories. These directories contain operating system files organized by function. This organization is not entirely logical; it has evolved over time and has its roots in several versions of UNIX. Table 5-1 lists the standard directories that most systems have. It also lists alternate names for those directories in some cases. The alternate names are usually an older pathname for the directory and are provided (as symbolic links) to ease the transition from old pathnames to new pathnames as the IRIX directory organization evolves.

**Table 5-1** Standard Directories and Their Contents

| Directory | Alternate Name | Contents   |
|-----------|----------------|--|
| /         |                | The root directory, contains the IRIX kernel (/unix), login files for the root login, and all other subdirectories |
| /CDROM    |                | Mount point for CDRoms, used by the mediad daemon  |
| /dev      |                | Device files for terminals, disks, tape drives, CD-ROM drives, and so on   |

**Table 5-1** Standard Directories and Their Contents (**continued**)

| Directory   | Alternate Name                  | Contents  |
|-------------|---------------------------------|---|
| /dev/fd     |                                 | File descriptor filesystem  |
| /etc        |                                 | Critical system configuration files and maintenance commands  |
| /etc/config | /var/config,<br>/usr/var/config | Configuration files for the scripts in /etc/init.d  |
| /etc/init.d |                                 | Scripts that execute during system initialization (the /etc/rc0.d and /etc/rc2.d directories serve a similar purpose)   |
| /hosts      |                                 | Default mount point for NFS filesystems mounted by autofs   |
| /hw         |                                 | Hardware graph filesystem   |
| /lib        |                                 | Critical compiler binaries and libraries  |
| /lib32      |                                 | Critical compiler binaries and libraries  |
| /lib64      |                                 | Critical compiler binaries and libraries for 64-bit systems (IP19, IP21, IP25, IP26, IP27, IP28 and IP30)   |
| /lost+found |                                 | Holding area for files recovered by the xfs_repair and fsck commands (there is also a /lost+found directory in the root of all mounted XFS and EFS filesystems) |
| /ns         |                                 | Default mount point for pseudo-filesystem interface to the Unified Name Service (UNS) supported by the nsd daemon.  |
| /opt        |                                 | Installation location for some third-party software   |
| /proc       | /debug                          | Process (debug) filesystem  |
| /sbin       |                                 | Commands needed for minimal system operability  |
| /stand      |                                 | Standalone utilities (fx)   |

**Table 5-1** Standard Directories and Their Contents (**continued**)

| Directory           | Alternate Name | Contents  |
|---------------------|----------------|---|
| /tmp                |                | Temporary files   |
| /tmp_mnt            |                | Mount point for automounted filesystems   |
| /usr                |                | On some systems, a filesystem mount point   |
| /usr/bin            | /bin           | Commands  |
| /usr/bin/X11        |                | Most standard X window system executables   |
| /usr/bsd            |                | Commands  |
| /usr/demos          |                | Demo programs   |
| /usr/etc            |                | Critical system configuration files and maintenance commands  |
| /usr/freeware       |                | Location of unsupported free software   |
| /usr/gnu            |                | GNU utilities   |
| /usr/include        |                | C header files  |
| /usr/lib            |                | Libraries and support files   |
| /usr/lib32          |                | Libraries and support files   |
| /usr/lib32/internal |                | Dynamic shared objects (DSOs) used by programs shipped by Silicon Graphics, Inc. (not used for compilation) |
| /usr/lib64          |                | Libraries and support files for 64-bit systems (IP19, IP21, IP25, IP26, IP27, IP28 and IP30)                |
| /usr/lib64/internal |                | Dynamic shared objects (DSOs) used by programs shipped by Silicon Graphics, Inc. (not used for compilation) |
| /usr/Motif-1.2      |                | Motif 1.2-specific binaries, headers, and libs  |
| /usr/people         |                | Home directories  |
| /usr/relnotes       |                | Release notes   |
| /usr/sbin           |                | Commands  |

**Table 5-1** Standard Directories and Their Contents (**continued**)

| Directory           | Alternate Name | Contents   |
|---------------------|----------------|--|
| /usr/share          |                | Shared data files for various applications (can be mounted via NFS as read-only)   |
| /usr/share/Insight  |                | InSight books  |
| /usr/share/catman   |                | Reference pages (man pages)  |
| /usr/var            |                | Present if / and /usr are separate filesystems                                     |
| /var                |                | System files likely to be customized or machine-specific                           |
| /var/X11            |                | X11 configuration files  |
| /var/adm            | /usr/adm       | System log files   |
| /var/inst           |                | Software installation history  |
| /var/inst/patchbase |                | Original installed files replaced in patches                                       |
| /var/mail           | /usr/mail      | Incoming mail  |
| /var/ns             |                | Protocol-specific dynamic shared objects (DSOs) and cache files for the nsd daemon |
| /var/preserve       | /usr/preserve  | Temporary editor files   |
| /var/spool          | /usr/spool     | Printer support files  |
| /var/tmp            | /usr/tmp       | Temporary files  |
| /var/yp             |                | NIS commands   |

## General Filesystem Concepts

A *filesystem* is a data structure that organizes files and directories on a disk partition so that they can be easily retrieved. Only one filesystem can reside on a disk partition.

A *file* is a one-dimensional array of bytes with no other structure implied. Information about each file is stored in structures called *inodes* (inodes are described in “Inodes” on page 107). Files cannot span filesystems.

A *directory* is a container that stores files and other directories. It is merely another type of file that the user is permitted to use, but not allowed to write; the operating system itself retains the responsibility for writing directories. Directories cannot span filesystems. The combination of directories and files make up a filesystem.

The starting point of any filesystem is an unnamed directory that serves as the root for that particular filesystem. In the IRIX operating system there is always one filesystem that is itself referred to by that name, the root filesystem. Traditionally, the root directory of the root filesystem is represented by a single slash (/). Filesystems are attached to the directory hierarchy by the `mount` command. The result is the IRIX directory structure shown in Figure 5-1.

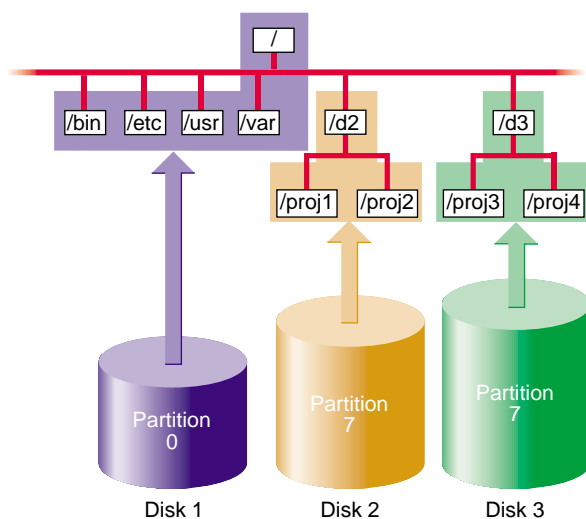

**Figure 5-1** The IRIX Filesystem

You can join two or more disk partitions to create a *logical volume*. The logical volume can be treated as if it were a single disk partition, so a filesystem can reside on a logical volume and hence is the only way for a single filesystem to span more than one disk. For more information on XLV logical volumes, see Chapter 3, “XLV Logical Volume Concepts.”

The following subsections describe key components of filesystems.

## Inodes

Information about each file is stored in a structure called an *inode*. The word *inode* is an abbreviation of the term *index node*. An inode is a data structure that stores all information about a file except its name, which is stored in the directory. Each inode has an identifying inode number, which is unique across the filesystem that includes the file.

An inode contains the following information:

- The type of the file (see “Types of Files” on page 108 for more information)
- The access mode of the file; the mode defines the access permissions *read*, *write*, and *execute* and may also contain security labels and access control lists
- The number of hard links to the file (see “Hard Links and Symbolic Links” on page 108 for more information)
- Who owns the file (the owner’s user-ID number) and the group to which the file belongs (the group-ID number)
- The size of the file in bytes
- The date and time the file was last accessed, and last modified
- Information for finding the file’s data within the disk partition or logical volume
- The pathname of symbolic links (when they fit and on XFS filesystems only)

You can use the `ls` command with various options to display the information stored in inodes. For example, the command `ls -l` displays all but the last two items in the list above in the order listed (the date shown is the last modified time).

Inodes do not contain the name of the file or its directory.

## Types of Files

Filesystems can contain the types of files listed Table 5-2. The type of a file is indicated by the first character in the line of `ls -l` output for the file.

**Table 5-2** Types of Files

| Type of File                      | Character | Description   |
|-----------------------------------|-----------|---|
| Regular files                     | -         | Regular files are one-dimensional arrays of bytes.  |
| Directories                       | d         | Directories are containers for files and other directories.   |
| Symbolic links                    | l         | Symbolic links are files that contain the name of another file or a directory.  |
| Character devices                 | c         | Character devices enable communication between hardware and IRIX; data is accessed on a character by character basis.   |
| Block devices                     | b         | Block devices enable communication between hardware and IRIX; data is accessed in blocks from a system buffer cache.  |
| Named pipes (also known as FIFOs) | p         | Named pipes allow communication between two unrelated processes running on the same host. They are created with the <code>mknod</code> command (see the <code>mknod(1M)</code> reference page for more information on <code>mknod</code> ). |
| UNIX domain sockets               | s         | UNIX domain sockets are connections between processes that allow them to communicate, possibly over a network.  |

## Hard Links and Symbolic Links

As discussed in “Inodes” on page 107, information about each file, except for the name and directory of the file, is stored in an inode for the file. The name of the file is stored in the file’s directory and a link to the file is created by associating the filename with an inode number. This type of link is called a *hard link*. Although every file is a hard link, the term is usually used only when two or more filenames are associated with the same inode number. Because inode numbers are unique only within a filesystem, hard links cannot be created across filesystem boundaries.



The second and later hard links to a file are created with the `ln` command, without the `-s` option. For example, suppose the current directory contains a file called `origfile`. To create a hard link called `linkfile` to the file `origfile`, enter this command:

```
% ln origfile linkfile
```

The output of `ls -l` for `origfile` and `linkfile` shows identical sizes and last modification times:

```
% ls -l origfile linkfile
-rw-rw-r--  2 joyce  user          4 Apr  5 11:15 origfile
-rw-rw-r--  2 joyce  user          4 Apr  5 11:15 linkfile
```

Because `origfile` and `linkfile` are simply two names for the same file, changes in the contents of the file are visible when using either filename. Removing one of the links has no effect on the other. The file is not removed until there are no links to it (the number of links to the file, the *link count*, is stored in the file's inode).

Another type of link is the *symbolic link*. This type of link is actually a file (see Table 5-2). The file contains a text string, which is the pathname of another file or directory. Because a symbolic link is a file, it has its own owners and permissions. The file or directory it points to can be in another filesystem. If the file or directory that a symbolic link points to is removed, it is no longer available and the symbolic link becomes useless until the target is recreated (it is called a *dangling symbolic link*).

Symbolic links are created with the `ln` command with the `-s` option. For example, to create a symbolic link called `linkdir` to the directory `origdir`:

```
% ln -s origdir linkdir
```

The output of `ls -ld` for the symbolic link is shown below. Notice that the permissions and other information do not match. The listing for `linkdir` shows that it is a symbolic link to `origdir`.

```
% ls -ld linkdir origdir
drwxrwxrwt 13 sys      sys  2048 Apr  5 11:37 origdir
lrwxrwxr-x  1 joyce   user    8 Apr  5 11:52 linkdir -> origdir
```

When you use `..` in pathnames that involve symbolic links, be aware that `..` refers to the parent directory of the true file or directory, not the parent of the directory that contains the symbolic link.

For more information about hard and symbolic links, see the `ln(1)` reference page and experiment with creating and removing hard and symbolic links.

## Filesystem Names

Filesystems do not have names per se; they are identified by their location on a disk or their position in the directory structure as follows:

- By the block and character device file names of the disk partition or logical volume that contains the filesystem (see “Block and Character Devices” in Chapter 1)
- By a mnemonic name for the disk partition or logical volume that contains the filesystem (see “Creating Mnemonic Names for Device Files With `ln`” in Chapter 2)
- By the mount point for the filesystem (see “Filesystem Mounting and Unmounting” on page 119)

The filesystem identifier from the list above that you use with commands that administer filesystems (such as `mkfs`, `mount`, `umount`, and `fsck`) depends upon the command. See the reference page for the command you want to use or examples in this guide to determine which filesystem name to use.

## XFS Filesystems

XFS is an IRIX filesystem designed for use on most Silicon Graphics systems—from desktop systems to supercomputer systems. Its major features include:

- Full 64-bit file capabilities (files larger than 2 GB)
- Rapid and reliable recovery after system crashes because of journaling technology
- Efficient support of large, sparse files (files with “holes”)
- Integrated, full-function volume manager, the XLV Volume Manager
- Extremely high I/O performance that scales well on multiprocessing systems
- Guaranteed-rate I/O for multimedia and data acquisition uses
- Compatibility with existing applications and with NFS
- User-specified filesystem block sizes ranging from 512 bytes up to 64 KB
- Small directories and symbolic links of 156 characters or less take no space

At least 32 MB of memory is recommended for systems with XFS filesystems.

XFS supports files and filesystems of  $2^{40}-1$  or 1,099,511,627,775 bytes (one terabyte) on 32-bit systems (IP17, IP20, IP22, and IP32). Files up to  $2^{63}-1$  bytes and filesystems of unlimited size are supported on 64-bit systems (IP19, IP21, IP25, IP26, and IP27). You can use the filesystem interfaces supplied with the IRIS Development Option (IDO) software option to write 32-bit programs that can track 64-bit position and file size. Many programs work without modification because sequential reads succeed even on files larger than 2 GB. NFS allows you to export 64-bit XFS filesystems to other systems.

XFS uses database journaling technology to provide high reliability and rapid recovery. Recovery after a system crash is completed within a few seconds, without the use of a filesystem checker such as the `fsck` command. Recovery time is independent of filesystem size.

XFS is designed to be a very high performance filesystem. Under certain conditions, throughput exceeds 100 MB per second. Its performance scales to complement the CHALLENGE MP architecture and the ORIGIN 2000 architecture. While traditional filesystems suffer from reduced performance as they grow in size, with XFS there is no performance penalty.

You can create filesystems with block sizes ranging from 512 bytes to 64 KB. For real-time data, the maximum *extent* size is 1 GB. Filesystem extents, which provide for contiguous data within a file, are created automatically for normal files and may be configured at file creation time for real-time files using the `fcntl()` system call. Extents are multiples of a filesystem block. Inodes are created as needed by XFS filesystems. You can specify the size of inodes with the `-i` option to the filesystem creation command, `mkfs`. You can also specify the maximum percentage of the space in a filesystem that can be occupied by inodes with the `-i maxpct=` option of the `mkfs` command.

A feature of XFS filesystems called extended attributes enables users and applications to associate name and value pairs to files, directories, symbolic links, and inodes. These name and value pairs are called attributes and can be set and displayed with the `attr` command. For more information see the, `attr(1)` reference page.

Two features of XFS filesystems enable applications to control their I/O bandwidth allocation. Guaranteed-rate I/O, described in Chapter 8, “System Administration for Guaranteed-Rate I/O,” enables a process to receive data from a system resource at a predefined rate, regardless of other activity on the system. Priority I/O, described in the `prio(5)` reference page, enables a process to reserve a portion of the system’s resources for its exclusive use for a period of time.

Most filesystem commands, such as `du`, `dvhtool`, `ls`, `mount`, `prtvtoc`, and `umount`, work with XFS filesystems with no user-visible changes. A few commands, such as `df`, `fx`, and `mkfs` have additional features for XFS. The filesystem commands `clri`, `fsck`, `findblk`, and `ncheck` are not used with XFS filesystems.

For backup and restore, use the standard IRIX commands `backup`, `bru`, `cpio`, `restore`, and `tar` and the optional software product NetWorker for IRIX for files smaller than 2 GB. To dump XFS filesystems, the command `xfsdump` must be used instead of `dump`. Restoring from these dumps is done using `xfsrestore`. For more information about the relationships between `xfsdump`, `xfsrestore`, `dump`, and `restore` on XFS filesystems, see the “About `xfsdump` and `xfsrestore`” section of the “Backup and Recovery Procedures” chapter of *IRIX Admin: Backup, Security, and Accounting*.

## CXFS Filesystems

CXFS is a clustered XFS filesystem that allows for logical file sharing, as with networked filesystems, but with significant performance and functionality advantages. CXFS runs on top of a storage area network (SAN), where each computer system in the cluster has direct high-speed data channels to a shared set of disks. Running CXFS requires a FLEXlm license key.

For information about the features of CXFS filesystems as well as information about installing and administering CXFS filesystems, see the *CXFS Software Installation and Administration Guide*.

## EFS Filesystems

---

**Note:** Support for EFS filesystems will be discontinued in a future IRIX release. For information on converting EFS filesystems to XFS filesystems, see Chapter 6, “Creating and Growing Filesystems.”

---

The EFS filesystem is the original IRIX filesystem. It contains an enhancement to the standard UNIX filesystem called *extents*, and thus is called the Extent File System (EFS). The maximum size of an EFS filesystem is about 8 GB. It uses a filesystem block size of 512 bytes and allows a maximum file size of 2 GB minus 1 byte.

Information on EFS filesystems and their administration is provided in Appendix A, “EFS Filesystems”.

## Network File Systems (NFS)

NFS filesystems are available if you are using the optional NFS software. NFS filesystems are filesystems that are exported from one host and mounted on other hosts across a network.

On the hosts where the filesystems reside, they are treated just like any other XFS filesystem. The only special feature of these filesystems is that they are exported for mounting from other workstations. Exporting NFS filesystems is done with the `exportfs` command. On other hosts, these filesystems are mounted with the `mount` command or by using the automount facility of NFS.

---

**Tip:** The section “Making Your Disk Space Available to Other Users” in Chapter 4 of the *Personal System Administration Guide* and the section “Using Disk Space on Other Systems” in Chapter 5 of the *Personal System Administration Guide* provide instructions for mounting and exporting NFS filesystems.

---

NFS filesystems are described in detail in the *ONC3/NFS Administrator’s Guide*, which is included with the NFS software option.

## Cache File Systems (CacheFS)

The Cache File System (CacheFS) is a new filesystem type that provides client-side caching for NFS and other filesystem types. Using CacheFS on NFS clients with local disk space can significantly increase the number of clients a server can support and reduce the data access time for clients using read-only file systems.

The `cfsadmin` command is used for managing CacheFS filesystems. A special version of the `fsck` command, `fsck_cacheofs` is used to check the integrity of a cache directory. It is automatically invoked when a CacheFS filesystem is mounted. When mounting and unmounting CacheFS filesystems, the `-t cacheofs` option must be used. For more information on these commands, see the `cfsadmin(1M)`, `fsck_cacheofs(1M)`, and `mount(1M)` reference pages.

CacheFS filesystems are available if you are using the optional NFS software. They are described in detail in the *ONC3/NFS Administrator's Guide*, which is included with the NFS software option.

## /proc Filesystem

The `/proc` filesystem, also known as the debug filesystem, provides an interface to running IRIX processes for use by monitoring programs, such as `ps` and `top`, and debuggers, such as `dbx`. The debug filesystem is usually mounted on `/proc` with a link to `/debug`. To reduce confusion, `/proc` is not displayed when you list free space with the `df` command.

The “files” of the debug filesystem are of the form `/proc/nnnnn` and `/proc/pinfo/nnnnn`, where `nnnnn` is a decimal number corresponding to a process ID. These files do not consume disk space; they are merely handles for debugging processes. `/proc` files cannot be removed.

See the `proc(4)` reference page for more information on the debug filesystem.

## /hw Filesystem

The hardware graph, also known as the *hwgraph*, is a feature of IRIX that facilitates the management of large and topologically complex I/O subsystems. The /hw filesystem is a visible reflection of the hwgraph. The /hw filesystem is a filesystem type, similar to /proc. Like /proc, /hw is not displayed when you list free space with the `df` command.

---

**Note:** The contents of the hardware graph and the links in it may change across hardware and software releases. For this reason, an administrator should use the /dev directory as the root of the path for all device file usage, even though the directories under /dev are links into /hw. For example, you should not use device names under /hw when mounting filesystems or configuring the root filesystem.

---

The hwgraph is a directed graph, consisting of a set of “vertexes” (points) that represent hardware entities and “edges” (lines) that connect the vertexes. Each edge is a one-way linkage from a source vertex to a target vertex (this is the definition of a directed graph). Each edge has a label, a character string that names the edge. A small part of a typical hwgraph is depicted in Figure 5-2.

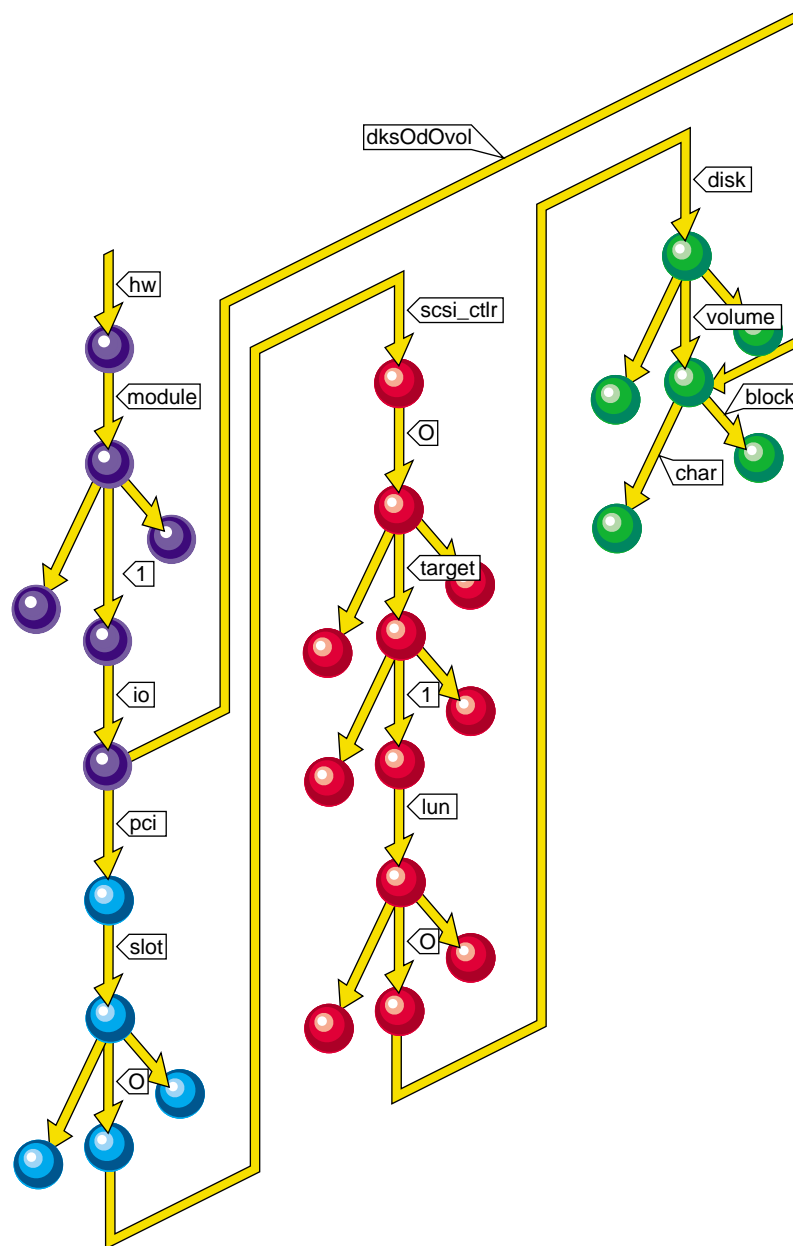

Figure 5-2 Part of a Typical Hwgraph



Figure 5-2 shows the part of the graph that represents block and character access to the whole-volume partition of a disk. Pathname notation is used to identify each hardware entity (vertex). The pathname consists of each of the edges in the path from the root to the hardware entity. For example, the two paths to each of the block and character devices might be:

```
/hw/module/1/io/pci/slot/0/scsi_ctlr/0/target/1/lun/0/disk/volume/block
/hw/module/1/io/pci/slot/0/scsi_ctlr/0/target/1/lun/0/disk/volume/char
/hw/module/1/io/dks0d0vol/block
/hw/module/1/io/dks0d0vol/char
```

The hwgraph is built dynamically (it has no on-disk contents) and changes to reflect changes in the hardware inventory. Figure 5-2 is color-coded to show the parts of graph are built by the kernel (black), the PCI bus adapter (red), the SCSI controller driver (magenta), and the disk device driver (green). In the hwgraph, logical controller numbers are used for each controller in the I/O subsystem, rather than physical controller numbers. These logical controller numbers are specified in the file `/etc/ioconfig.conf`. For more information, see the `ioconfig(1M)` reference page. The `ioconfig(1M)` reference page also describes the configuration file `/etc/ioperms`, which contains information about the owner, group, and permissions of devices in the hwgraph.

You can navigate the `/hw` filesystem using commands such as `cd`, `ls`, and `find` and browse it to discover the hardware configuration. Symbolic links to `/hw` paths exist to all the device special filenames that are conventionally expected to exist in `/dev`, with the exception of XLV logical volumes. The symbolic links are implemented by creating them from `/dev` to `/hw`. Here is a typical link:

```
lrwxr-xr-x  1 root  sys  13 Aug  6 11:23 /dev/root -> /hw/disk/root
```

Do not remove `/hw`; very little on the system works without it.

## Foreign Filesystems

The IRIX operating system supports four filesystem formats native to other operating systems. These filesystem formats are as follows:

|                               |   |
|-------------------------------|---|
| <code>hfs (mac)</code>        | The filesystem used by Macintosh computers  |
| <code>dos (fat)</code>        | The filesystem used by IBM-compatible personal computers  |
| <code>iso9660 (CD-ROM)</code> | A CD-ROM filesystem type conforming to ISO standard 9660  |
| <code>cdda</code>             | Compact disk digital audio  |
| <code>UDF</code>              | The filesystem used for DVDs. IRIX supports writable UDF filesystems on DVD-RAM media or hard disks only. IRIX support for UDF filesystems does not include support for playing DVD movies. |

For further information on the filesystem types that IRIX supports, see the `filesystems(4)` reference page. For information on administering `hfs` and `dos` filesystems, see the `mkfp(1M)` and `fpck(1M)` reference pages.

## XFS Filesystem Creation

To turn a disk partition or logical volume into an XFS filesystem, the `mkfs` command must be used. It takes a disk partition or logical volume and divides it up into areas for data blocks, inodes, and free lists, and writes out the appropriate inode tables, superblocks, and block maps. It creates the filesystem's root directory.

The following `mkfs` example makes an XFS filesystem with a 1 MB internal log section is:

```
# mkfs -l size=1m /dev/rdisk/dks0d2s7
```

The following `mkfs` example makes an XFS filesystem on a logical volume with log and data subvolumes is:

```
# mkfs /dev/rxlv/a
```

For more instructions on making XFS filesystems see Chapter 6, "Creating and Growing Filesystems," and the `mkfs(1M)` and `mkfs_xfs(1M)` reference pages.

## Filesystem Mounting and Unmounting

Filesystems must be *mounted* to be used. Figure 5-3 illustrates this process. When a filesystem is mounted, the name of the device file for the filesystem (`/dev/rdisk/dks0d2s7` in Figure 5-3) and the name of a directory (`/proj` in Figure 5-3) are given. This directory, `/proj`, is called a *mount point* and forms the connection between the filesystem containing the mount point and the filesystem to be mounted. Mounting a filesystem tells the kernel that the mount point is to be considered equivalent to the top level directory of the filesystem when pathnames are resolved. In Figure 5-3, the files `a`, `b`, and `c` in the `/dev/rdisk/dks0d2s7` filesystem become `/proj/a`, `/proj/b`, and `/proj/c` as shown in the bottom of the figure.

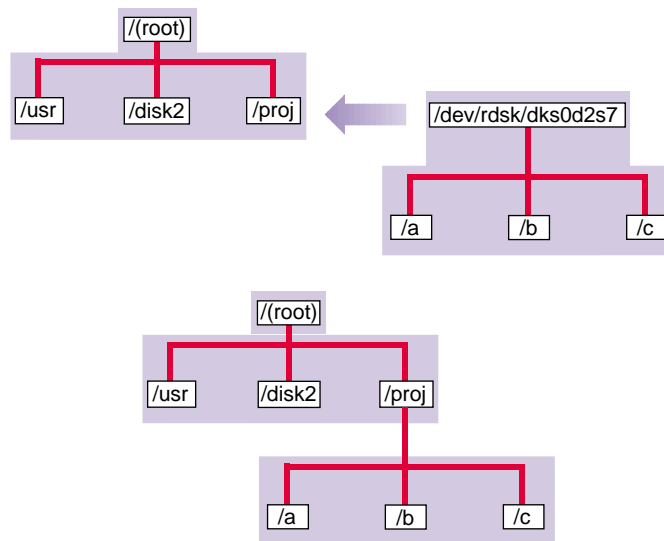

**Figure 5-3** Mounting a Filesystem

When you mount a filesystem, the original contents of the mount point directory are hidden and unavailable until the filesystem is unmounted. However, the mount point directory owner and permissions are not hidden. Restricted permissions can restrict access to the mounted filesystem.

Unlike other filesystems, the root filesystem (`/`) is mounted as soon as the kernel is running and cannot be unmounted because it is required for system operation. The `usr` filesystem, if it is a separate filesystem from the root filesystem, must also be mounted for the system to operate properly. System administration that requires unmounting the root and `usr` filesystem can be done in the `miniroot`. See “XFS Filesystem Checking” on page 120 for more information.

You can mount filesystems in several ways:

- Manually with the `mount` command (see “Manually Mounting Filesystems” on page 154)
- Automatically when the system is booted, using information in the file `/etc/fstab` (see “Mounting Filesystems Automatically With the `/etc/fstab` File” on page 155)
- Automatically when the filesystem is accessed (called *automounting*, which applies to NFS (remote) filesystems only; see “Mounting a Remote Filesystem Automatically” on page 157)
- Automatically when a removable disk is inserted (see the `mediad(1M)` reference page for information on the daemon that monitors removable media devices)

You can unmount filesystems in two ways:

- Shut down the system (filesystems are unmounted automatically)
- Manually unmount filesystems with the `umount` command (see the section “Unmounting Filesystems” on page 157)

The `mount` and `umount` commands are described in detail in “Mounting and Unmounting Filesystems” on page 154.

## XFS Filesystem Checking

The `xfs_check` command checks XFS filesystem consistency. It is normally used only when a filesystem consistency problem is suspected. See the `xfs_check(1M)` reference page for more information.

## Filesystem Reorganization

Filesystems can become fragmented over time. When a filesystem is fragmented, blocks of free space are small and files have many extents. The `fsr` command reorganizes filesystems so that the layout of the extents is improved. This improves overall performance.

By default, `fsr` is run automatically once a week from `crontab`. If the `fsr` command determines that a mounted filesystem is an XFS filesystem, the command calls the `fsr_xfs` command. See the `fsr(1M)` reference page for information on the `fsr` command, and the `fsr_xfs(1M)` man page for information on the `fsr_xfs` options for the command.

## Filesystem Administration From the Miniroot

When filesystem modifications or other administrative tasks require that the root filesystem not be mounted or not be in use, the miniroot environment provided by the software installation tools included on IRIX system software release CDs can be used. When using the miniroot, a limited version of IRIX is installed in the swap partition in a filesystem mounted at `/`. The system runs this version of IRIX rather than the standard IRIX in the root and `usr` filesystems. The root and `usr` filesystems are available and mounted at `/root` and `/root/usr`. Thus the pathnames of all files in the root and `usr` filesystems have the prefix `/root`.

## How to Add Filesystem Space

You can add filesystem space in three ways:

- Add a new disk, create a filesystem on it, and mount it as a subdirectory on an existing filesystem.
- Change the size of the existing filesystems by removing space from one partition and adding it to another partition on the same disk.
- Add another disk and grow an existing XFS filesystem onto that disk with the `xfs_growfs` command.

These three methods of adding filesystem space are discussed in the following subsections.

## Mount a Filesystem as a Subdirectory

To mount a filesystem as a subdirectory, you simply add a new disk with a separate filesystem and create a new mount point for it within your filesystem. This is generally considered the safest way to add space. For example, if your `usr` filesystem is short of space, add a new disk and mount the new filesystem on a directory called `/usr/work`. A drawback of this approach is that it does not allow hard links to be created between the original filesystem and the new filesystem.

See Chapter 2, “Performing Disk Administration Procedures,” for full information on partitioning a disk and making filesystems on it.

## “Steal” Space From Another Filesystem

To move disk space from one filesystem on a disk to another filesystem on the same disk, you must back up your existing data on both filesystems; run the `fx` command to repartition the disk; then remake both filesystems with the `mkfs` command. This method has serious drawbacks. It is a great deal of work and has certain risks. For example, to increase the size of a filesystem, you must remove space from other filesystems. You must be sure that when you finish changing the size of your filesystems, your old data still fits on all the new, smaller filesystems. Also, resizing your filesystems may at best be a stop-gap measure until you can acquire additional disk space.

Repartitioning is documented in “Repartitioning a Disk With `fx`” on page 27. For additional solutions when the filesystem is the root filesystem, see “Running Out of Space in the Root Filesystem” on page 168.

## Grow an XFS Filesystem Onto Another Disk

Growing an existing filesystem onto an additional disk or disk partition is another way to increase the available space in that filesystem. The original disk partition and the new disk partition become a logical volume. The `xfs_growfs` command preserves the existing data on the hard disk and adds space from the new disk partition to the filesystem. This process is simpler than completely remaking your filesystems. The one drawback to growing a filesystem across disks is that if one disk fails, you may not recover data from the other disk, even if the other disk still works. If your `usr` filesystem is a logical volume, you will be unable to boot the system into multiuser mode. For this reason, it is preferable, if possible, to mount an additional disk and filesystem as a directory on the root or `usr` filesystems (on `/` or `/usr`).

---

For instructions on growing a filesystem onto an additional disk, see “Growing an XFS Filesystem Onto Another Disk” on page 138.

## Disk Quotas

If your system is constantly short of disk space and you cannot increase the amount of available space, you may be forced to implement disk quotas. Quotas allow you to limit the amount of space a user can occupy and the number of files (inodes) each user can own. IRIX provides disk quotas to automate this process. You can use this system to implement specific disk usage quotas for each user on your system. You can implement *hard* or *soft* limits; hard limits are enforced by the system, soft limits merely remind the user to trim disk usage. Disk usage limits are not enforced for *root*.

With soft limits, whenever a user logs in with a usage greater than the assigned soft limit, that user is warned (by the `login` command). When the user exceeds the soft limit, the timer is enabled. Any time the quota drops below the soft limits, the timer is disabled. If the timer is enabled longer than a time period set by the system administrator, the particular limit that has been exceeded is treated as if the hard limit has been reached, and no more disk space is allocated to the user. The only way to reset this condition is to reduce usage below the quota. Only *root* may set the time limits, and this is done on a per-filesystem basis.

Several options are available on XFS filesystems. You can impose limits on some users and not others, some filesystems and not others, and on total disk usage per user, or total number of files. In addition, on XFS filesystems there is no limit to the number of accounts and there is little performance penalty for large numbers of users.

On XFS filesystems, you can also impose limits according to project IDs or group IDs as well as user IDs. Quotas based on project IDs and quotas based on group IDs are mutually exclusive. For information on project and group IDs and how they are established, see *IRIX Admin: Backup, Security, and Accounting*. For information on using disk quotas for project or group IDs, see “Using Disk Quotas on XFS Filesystems” on page 169.

Disk quotas on XFS filesystems can be used to do disk usage accounting. Disk usage accounting monitors disk usage, but does not enforce disk usage limits. See “Identifying Accounts That Use Large Amounts of Disk Space” on page 163 for more information.

Disk quotas are described in more detail in the `quotas(4)` reference page. Procedures for imposing and monitoring disk quotas are described in “Using Disk Quotas on XFS Filesystems” on page 169.

## Filesystem Corruption

Most often, a filesystem is corrupted because the system experienced a panic or did not shut down cleanly. This can be caused by system software failure, hardware failure, or human error (for example, pulling the plug). Another possible source of filesystem corruption is overlapping partitions.

There is no foolproof way to predict hardware failure. The best way to avoid hardware failures is to conscientiously follow recommended diagnostic and maintenance procedures.

Human error is probably the greatest single cause of filesystem corruption. To avoid problems, follow these rules closely:

- Always shut down the system properly. Do not simply turn off power to the system. Use a standard system shutdown tool, such as the `shutdown` command.
- Never remove a filesystem physically (pull out a hard disk) without first turning off power.
- Never physically write-protect a mounted filesystem, unless it is mounted read-only.
- Do not mount filesystems on dual-hosted disks on two systems simultaneously.

The best way to insure against data loss is to make regular, careful backups. See *IRIX Admin: Backup, Security, and Accounting* for complete information on system backups.

In some cases, XFS filesystem corruption, even on the root file system, can be repaired with the command `xfs_repair`. For more information about `xfs_repair` see “Checking XFS Filesystem Consistency With `xfs_check` and `xfs_repair`” on page 176.



## Creating and Growing Filesystems

This chapter describes the procedures you must perform to create or grow (increase the size of) an XFS filesystem or to convert from an EFS filesystem to an XFS filesystem.

The major sections in this chapter are:

- “Planning an XFS Filesystem” on page 125
- “Making an XFS Filesystem” on page 132
- “Making a Filesystem From `inst`” on page 137
- “Making a Foreign Filesystem” on page 138
- “Growing an XFS Filesystem Onto Another Disk” on page 138
- “Converting Filesystems on the System Disk From EFS to XFS” on page 140
- “Converting a Filesystem on an Option Disk From EFS to XFS” on page 148
- “Checking for Adequate Free Disk Space When Converting to XFS Filesystems” on page 149
- “Dump and Restore Requirements When Converting to XFS Filesystems” on page 151

### Planning an XFS Filesystem

The following subsections discuss preparation for and choices you must make when creating an XFS filesystem. Each time you plan to make an XFS filesystem or convert a filesystem from EFS to XFS, review each section and make any necessary preparations.

### Prerequisite Software

If you are converting the `root` and `usr` filesystems to XFS, you must have software distribution CDs or access to a remote distribution directory for IRIX system software.

## Choosing the Filesystem Block Size and Extent Size

XFS allows you to choose the logical block size for each filesystem. (Physical disk blocks remain 512 bytes.) If you use a real-time subvolume on an XLV logical volume, you must also choose the extent size. The extent size is the amount of space that is allocated to a file each time it needs more space.

For XFS filesystems on disk partitions and logical volumes and for the data subvolume of filesystems on XLV volumes, the block size guidelines are as follows:

- The minimum block size is 512 bytes. Small block sizes increase allocation overhead which decreases filesystem performance, but in general, the recommended block size for filesystems under 100 MB and for filesystems with many small files is 512 bytes. The filesystem block size must be a power of two.
- The default block size is 4096 bytes (4K). This is the recommended block size for filesystems over 100 MB.
- The maximum block size is 65536 bytes (64K). Because large block sizes can waste space and lead to fragmentation, in general block sizes should not be larger than 4096 bytes (4K).
- For the root filesystem on systems with separate root and `usr` filesystems, the recommended block size is 512 bytes. For systems where root and `usr` are not separate filesystems, the recommended block size is 4096 bytes, the default block size.
- For news servers, it is recommended that you use a version 2 directory format with a filesystem block size of 512 bytes and a directory block size of 4096 bytes. For information on using version 2 directories see “Choosing the Filesystem Directory Format and Directory Block Size” on page 127.

Block sizes are specified in bytes in decimal (default), octal (prefixed by 0), or hexadecimal (prefixed by 0x or 0X). If the number has the suffix “k,” it is multiplied by 1024. If the number has the suffix “m,” it is multiplied by 1048576 (1024 \* 1024).

The guidelines for the extent size are as follows:

- The extent size must be a multiple of the block size of the data subvolume.
- The minimum extent size is 4 KB.
- The maximum extent size is 1 GB.
- The default extent size is 64 KB.

- The extent size should be matched to the application and the stripe unit of the volume elements used in the real-time subvolume.

A filesystem extent is considered *unwritten* if it is allocated to a file and has never been written by anyone after the allocation. This can occur when you use `F_RESVSP` parameter of the `fcntl(2)` system call to preallocate space. If you preallocate space and then read the data when the extent is unwritten, you could see the old contents of the data. This could have been written by another user, and may break security.

When you define an XFS filesystem, you can specify whether unwritten extent tracking is on. This causes XFS to keep track of unwritten extents and does not allow a read to return old data. When unwritten extent tracking is on, a read on an unwritten extent returns a value of 0. Unwritten extent tracking is on by default in IRIX 6.5 systems and later.

## Choosing the Filesystem Directory Format and Directory Block Size

XFS supports two on-disk directory formats, referred to as *version 1* and *version 2* in `mkfs` output. The version you choose when you create a filesystem applies to all the directories in a filesystem. Version 1 is the original IRIX filesystem directory format; version 2 was added with the 6.5.5 release of IRIX and is the default. You choose the directory format with the `-n` parameter of the `mkfs` command.

An XFS file system with version 2 directory format allows you to select a logical block size for the filesystem directory that is greater than the logical block size of the filesystem. This allows you to choose a filesystem block size to match the distribution of data file sizes without adversely affecting directory operation performance. Using this option could improve performance for a filesystem with many small files, such as a news or mail filesystem. In this case, the filesystem logical block size could be small (512, 1K, or 2K bytes) and the logical block size for the filesystem directory could be large (4K or 8K bytes); this can improve the performance of directory lookups because the tree storing the index information has larger blocks and less depth.

You should consider setting a logical block size for a filesystem directory that is greater than the logical block size for the filesystem if you are supporting an application that reads directories (with the `readdir(3C)` or `getdents(2)` system calls) many times in relation to how much it creates and removes files. Using a small filesystem block size saves on disk space and on I/O throughput for the small files.

In an XFS file system with version 2 directory format, the data needed to perform a `readdir` operation is segregated from the index information. Directory data blocks can be “read-ahead” in a `readdir` on a version 2 directory block; this is not possible with a version 1 directory block. Performing read-ahead improves the `readdir` performance dramatically.

Because the data needed for a `readdir` operation and index information are separate in a version 2 directory block, the offset in a directory is limited to 32 bits. In a version 1 directory block, a 64-bit offset is used. A 64-bit offset can cause some interoperability problems for 32-bit clients such as NFS V2, DFS and 32-bit (O32) applications.

SGI recommends that all new XFS filesystems be created with version 2 directories. IRIX releases older than IRIX 6.5.5, however, are not be able to mount a filesystem created with a version 2 directory and will issue the following message when a mount is attempted:

```
Wrong filesystem type: xfs
```

There is no means for converting a filesystem, in place, between version 1 and version 2 directories. A filesystem can be converted between version 1 and version 2 directories by means of an `xfsdump/mkfs/xfsrestore` sequence.

For information on using the `-n` option of `mkfs` to select a version 1 directory format, see the `mkfs_xfs(1M)` man page.

## Choosing the Log Type and Size

Each XFS filesystem has a log that contains filesystem journaling records. This log requires dedicated disk space. This disk space doesn’t show up in listings from the `df` command, nor can you access it with a filename.

The location of the disk space depends on the type of log you choose. The two types of logs are:

|          |   |
|----------|---|
| External | When an XFS filesystem is created on an XLV logical volume and log records are put into a log subvolume, the log is called an <i>external</i> log. The log subvolume is one or more disk partitions dedicated to the log exclusively. |
|----------|---|

**Internal**            When an XFS filesystem is created on a disk partition or XLV logical volume, or when it is created on an XLV logical volume that does not have a log subvolume, log records are put into a dedicated portion of the disk partition (or data subvolume) that contains user files. This type of log is called an *internal* log.

The guidelines for choosing the log type are as follows:

- If you want the log and the data subvolume to be on different partitions or to use different subvolume configurations for them, use an external log.
- If you want the log subvolume to be striped independently from the data subvolume (see “Volume Elements” in Chapter 3 for an explanation of striping), you must use an external log.
- If you are making the XFS filesystem on a disk partition (rather than on an XLV logical volume), you must use an internal log.
- If you are making the XFS filesystem on an XLV logical volume that has no log subvolume, you must use an internal log.
- If you are making the XFS filesystem on an XLV logical volume that has a log subvolume, you must use an external log.

For more information about XLV and log subvolumes, see Chapter 3, “XLV Logical Volume Concepts.”

The amount of disk space needed for the log is a function of how the filesystem is used. The amount of disk space required for log records is proportional to the transaction rate and the size of transactions on the filesystem, not the size of the filesystem. Larger block sizes result in larger transactions. Transactions from directory updates (for example, the `mkdir` and `rmdir` commands and the `create()` and `unlink()` system calls) cause more log data to be generated.

You can choose the amount of disk space to dedicate to the log (called the log size). The minimum log size for a filesystem is enforced by the size of the largest transaction, which depends on the filesystem and directory block sizes. The maximum log size is 64k blocks or 128 MB, whichever is smaller (this will depend on the block size).

For filesystems with a very high transaction activity, a large log size is recommended. You should avoid making your log too large, however, since a large log can increase filesystem mount time after a crash.

The default log size grows with the size of the filesystem up to the maximum log size, 128 megabytes, on a 1 terabyte filesystem.

For a filesystem which is contained in a XLV striped logical volume, the default internal log size is rounded up to a multiple of the stripe unit size. In this case, the user-specified size value must be a multiple of the stripe unit size.

For external logs, the size of the log is the same as the size of the log subvolume. The log subvolume is one or more disk partitions. You may find that you need to repartition a disk to create a properly sized log subvolume (see the section “Disk Repartitioning” on page 131).

For external logs, the size of the log is set when you create the log subvolume with the `xlv_make` command. For internal logs, the size of the log is specified with the `-l size=` option when you create the filesystem with the `mkfs` command.

The log size is specified in bytes as described in “Choosing the Filesystem Block Size and Extent Size” on page 126, or as a multiple of the filesystem block size by using the suffix “b.”

## Choosing Allocation Groups and Stripe Units

The data section of an XFS filesystem is divided into allocation groups. You can select the number of allocation groups when you create an XFS filesystem or, alternatively, you can select the size of an allocation group. The larger the number of allocation groups, the more parallelism can be achieved when allocating blocks and inodes. You should avoid selecting a very large number of allocation groups or an allocation group size that will yield a very large number of allocation groups; a large number of allocation groups causes an unreasonable amount of CPU time to be used when the filesystem is close to full.

The minimum allocation group size is 16MB; the maximum size is just under 4 GB.

The default number of allocation groups is 8, unless the filesystem is smaller than 128 MB or larger than 8 GB. When the filesystem is smaller than 128 MB, the default number of allocation groups is less than 8, since the minimum allocation group size is 16MB. In this case, the data section, by default, will be divided into as many allocation groups as possible that are at least 16MB. When the filesystem is larger than 8GB, but smaller than 64GB, the default number of allocation groups is greater than 8, with each allocation

group approximately 1 GB in size. When the filesystem is larger than 64GB, the default number of allocation groups is still greater than 8, but the allocation group size is 4GB.

XFS allows you to select the stripe unit for a RAID device or XLV stripe volume. This ensures that data allocations, inode allocations, and the internal log will be aligned along stripe units when the end of file is extended and the file size is larger than 512KB. You specify stripe units in 512-byte block units or in bytes; when you specify stripe units in bytes, the value must be a multiple of the filesystem block size. See the `mkfs_xfs(1M)` man page for information on specifying stripe units.

When you specify a stripe unit, you also specify a stripe width. You specify a stripe width in 512-byte block units or in bytes. The stripe width must be a multiple of the stripe unit. The stripe width will be the preferred I/O size returned in the `stat()` system call. See the `mkfs_xfs(1M)` man page for information on specifying stripe width.

When used in conjunction with the `-b` option of the `mkfs` command, you can use the `-d su=` and `-d sw=` options to specify the stripe unit and stripe width in filesystem blocks.

For a RAID device, the default stripe unit is 0, indicating that the feature is disabled. It is prudent of the sysadmin to configure the stripe unit and width sizes of RAID devices. This should be done to avoid unexpected performance anomalies caused by the filesystem doing non-optimal I/O operations to the RAID unit. For example, if a block write is not aligned on a RAID stripe unit boundary and is not a full stripe unit, the RAID will be forced to do a read/modify/write cycle to write the data. This can have a significant performance impact. By setting the stripe unit size properly, XFS will avoid unaligned accesses.

For a striped XLV volume, the stripe unit that was specified when the XLV volume was created is provided by default. For information on what to consider when choosing a stripe unit size, see “Striped Volume Elements” in Chapter 3, “XLV Logical Volume Concepts.”

## Disk Repartitioning

Many system administrators may find that they want or need to repartition disks when they switch to XFS filesystems and/or XLV logical volumes. Some of the reasons to consider repartitioning are:

- If the system disk has separate partitions for root and `usr` filesystems, the root filesystem may be running out of space. Repartitioning is a way to increase the space in root (at the expense of the size of `usr`) or to solve the problem by combining root and `usr` into a single partition.
- System administration is a little easier on systems with combined root and `usr` filesystems.
- If you plan to use XLV logical volumes, you may want to put the XFS log into a small subvolume. This requires disk repartitioning to create a small partition for the log subvolume.
- If you plan to use XLV logical volumes, you may want to repartition to create disk partitions of equal size that can be striped or plexed.

Disk partitions are discussed in Chapter 1, “Disk Concepts.” Using `fx` to repartition disks is explained in “Repartitioning a Disk With `fx`” on page 27.

## Making an XFS Filesystem

This section explains how to create an XFS filesystem on an empty disk partition or XLV logical volume. (For information about creating XLV logical volumes, see Chapter 4, “Creating and Administering XLV Logical Volumes.”)

---

**Tip:** You can make an XFS filesystem on a disk partition or a logical volume using the graphical user interface of the `xfsm` command. For information, see its online help.

---

**Caution:** When you create a filesystem, all files already on the disk partition or logical volume are destroyed.

---

1. Review “Planning an XFS Filesystem” on page 125 to verify that you are ready to begin this procedure.
2. Identify the device name of the partition or logical volume where you plan to create the filesystem. This is the value of *partition* in the examples below. For example, if you plan to use partition 7 (the entire disk) of a SCSI option disk on controller 0 and



drive address 2, *partition* is `/dev/dsk/dks0d2s7`. For more information on determining *partition*, see Table 1-4 on page 17, “Introduction to XLV Logical Volumes” on page 51, and the `dks(7M)` reference page.

3. If the disk partition is already mounted, unmount it:

```
# umount partition
```

Any data that is on the disk partition is destroyed. To convert the data rather than destroy it, use the procedure in “Converting a Filesystem on an Option Disk From EFS to XFS” on page 148 instead.

4. If you are making a filesystem on a disk partition or on an XLV logical volume that does not have a log subvolume and want to use the default values for block size and log size, use this `mkfs` command to create the new XFS filesystem:

```
# mkfs partition
```

Example 6-1 shows the command line to create an XFS filesystem using the defaults and system output.

**Example 6-1** `mkfs` Command for an XFS Filesystem Using Defaults

```
# mkfs /dev/dsk/dks0d4s7
meta-data=/dev/dsk/dks0d4s7      isize=256    agcount=9, agsize=262144 blks
data      =                      bsize=4096  blocks=2222178, imaxpct=25
          =                      sunit=0       swidth=0 blks, unwritten=1
naming    =version 2             bsize=4096
log       =internal log         bsize=4096  blocks=1200
realtime  =none                  extsz=65536 blocks=0, rtextents=0
```

5. If you are making a filesystem on a disk partition or on an XLV logical volume that does not have a log subvolume and want to specify the block size and log size, use this `mkfs` command to create the new XFS filesystem:

```
# mkfs -b size=blocksize -l size=logsize partition
```

*blocksize* is the filesystem block size (see “Choosing the Filesystem Block Size and Extent Size” on page 126) and *logsize* is the size of the area dedicated to log records (see “Choosing the Log Type and Size” on page 128). The default values are 4 KB blocks and a 1000-block log.

Example 6-2 shows the command line used to create an XFS filesystem and the system output. The filesystem has a 10 MB internal log and a block size of 1 KB and is on the partition `/dev/dsk/dks0d4s7`.

**Example 6-2** `mkfs` Command for an XFS Filesystem With an Internal Log

```
# mkfs -b size=1k -l size=10m /dev/dsk/dks0d4s7
meta-data=/dev/dsk/dks0d4s7      isize=256      agcount=9, agsize=1048576 blks
data      =                      bsize=1024    blocks=8888712, imaxpct=25
          =                      sunit=0       swidth=0 blks, unwritten=1
naming    =version 2             bsize=4096
log       =internal log         bsize=1024    blocks=10240
realtime  =none                 extsz=65536   blocks=0, rtextents=0
```

6. If you are making a filesystem on an XLV logical volume that has a log subvolume (for an external log), use this `mkfs` command to make the new XFS filesystem:

```
# mkfs -b size=blocksize volume
```

*blocksize* is the block size for filesystem (see “Choosing the Filesystem Block Size and Extent Size” on page 126), and *volume* is the device name for the volume.

Example 6-3 shows the command line used to create an XFS filesystem on a logical volume `/dev/xlv/a` with a block size of 1K bytes and the system output.

**Example 6-3** `mkfs` Command for an XFS Filesystem With an External Log

```
# mkfs -b size=1k /dev/xlv/a
meta-data=/dev/xlv/a      isize=256    agcount=9, agsize=1048576 blks
data      =              bsize=1024   blocks=8888712, imaxpct=25
          =              sunit=0             swidth=0 blks, unwritten=1
naming    =version 2     bsize=4096
log       =volume log    bsize=1024   blocks=32768
realtime  =none          extsz=65536  blocks=0, rtextents=0
```

Example 6-4 shows the command line used to create an XFS filesystem on a logical volume `/dev/xlv/xlv_data1` that includes a log, data, and real-time subvolumes and the system output. The default block size of 4096 bytes is used and the real-time extent size is set to 128 KB.

**Example 6-4** `mkfs` Command for an XFS Filesystem With a Real-Time Subvolume

```
# mkfs -r extsize=128k /dev/xlv/xlv_data1
meta-data=/dev/xlv/xlv_data1  isize=256    agcount=9, agsize=262144 blks
data      =                  bsize=4096   blocks=2222178, imaxpct=25
          =                  sunit=0             swidth=0 blks, unwritten=1
naming    =version 2         bsize=4096
log       =volume log        bsize=4096   blocks=8192
realtime  =volume rt         extsz=131072 blocks=1077787, rtextents=33680
```

7. If you are making a filesystem with a version 2 directory format with a directory block size that is larger than the filesystem block size, use this `mkfs` command to create the new XFS filesystem:

```
# mkfs -b size=blocksize -n size=dirblocksize partition
```

*blocksize* is the filesystem block size (see “Choosing the Filesystem Block Size and Extent Size” on page 126) and *dirblocksize* is the directory block size (see “Choosing the Filesystem Directory Format and Directory Block Size” on page 127).

Example 6-5 shows the command line used to create an XFS filesystem and the system output. The filesystem has a 512-byte filesystem block and a 4K directory block and is on the partition `/dev/dsk/dks0d4s7`. You might use this filesystem to store mail or news files.

**Example 6-5** `mkfs` Command for an XFS Filesystem Specifying Directory Block Size

```
# mkfs -b size=512 -n size=4k /dev/dsk/dks0d4s7
meta-data=/dev/dsk/dks0d4s7      isize=256    agcount=9, agsize=2097152 blks
data      =                      bsize=512   blocks=17777424, imaxpct=25
          =                      sunit=0      swidth=0 blks, unwritten=1
naming    =version 2             bsize=4096
log       =internal log         bsize=512   blocks=4944
realtime  =none                 extsz=65536 blocks=0, rtextents=0
```

8. If you are making a filesystem that you will mount on a system running an IRIX release older than IRIX 6.5.5 and you need to create a filesystem with the older, version 1 directory format, use this `mkfs` command to create the new XFS filesystem:

```
# mkfs -b -n version=1 partition
```

Example 6-6 shows the command line used to create an XFS filesystem and the system output. The filesystem has a 512-byte filesystem block and a version 1 directory structure and is on the partition `/dev/dsk/dks0d4s7`.

**Example 6-6** `mkfs` Command for an XFS Filesystem with Version 1 Directory Format

```
# mkfs -b size=512 -n version=1 /dev/dsk/dks0d4s7
meta-data=/dev/dsk/dks0d4s7      isize=256    agcount=9, agsize=2097152 blks
data      =                      bsize=512   blocks=17777424, imaxpct=25
          =                      sunit=0      swidth=0 blks, unwritten=1
naming    =version 1             bsize=512
log       =internal log         bsize=512   blocks=4944
realtime  =none                 extsz=65536 blocks=0, rtextents=0
```

9. To use the filesystem, you must mount it. For example:

```
# mkdir mountdir  
# mount partition mountdir
```

For more information about mounting filesystems, see “Manually Mounting Filesystems” in Chapter 7.

10. To configure the system so that the new filesystem is automatically mounted when the system is booted, add this line to the file `/etc/fstab`:

```
partition mountdir xfs rw,raw=rawpartition 0 0
```

where *rawpartition* is the raw version of *partition*. For example, if *partition* is `/dev/dsk/dks0d2s7`, *rawpartition* is `/dev/rdisk/dks0d2s7`.

For more information about automatically mounting filesystems, see the section “Mounting Filesystems Automatically With the `/etc/fstab` File” in Chapter 7.

## Making a Filesystem From inst

---

**Caution:** When you create a filesystem, all files already on the disk partition or logical volume are destroyed.

---

`mkfs` can be used from within the `inst` command to make filesystems. To make the root or `usr` filesystem on a system disk, you must use `inst` from the miniroot. There are two ways to use `mkfs`:

- The `mkfs` command on the Administrative Command Menu. The `mkfs` command makes an XFS filesystem and uses default values for the `mkfs` command options. With no argument, the `mkfs` command makes the root filesystem, and if a `usr` partition is present, a `usr` filesystem. Other filesystems can be made by giving a device file argument to `mkfs`.
- From a shell. Giving the `mkfs` command from a shell (give the command `sh`, not `shroot`) enables you to specify the `mkfs` command line, including options.

For more information about making filesystems from `inst`, see *IRIX Admin: Software Installation and Licensing*.

## Making a Foreign Filesystem

Under the IRIX operating system, you can use the `mkfcp` command to create `hfs` (`mac`) and `dos` (`fat`) filesystems on devices such as floppies, floptical disks, SyQuest, Jaz, PC Cards, Zip, magneto-optical and hard drives.

The `mkfcp` utility can create single `dos` partitions on floppies and floptical disks as well as multiple `dos` partitions on other forms of media. However, the `mkfcp` utility can create only single `hfs` partitions spanning entire disks. You cannot use the `mkfcp` utility to manipulate existing partitions on disk.

For information on using the `mkfcp` utility, see the `mkfcp(1M)` reference page. For further information on foreign filesystem types, see the `filesystems(4)` reference page. For information on checking and repairing foreign filesystems, see the `fpck(1M)` reference page.

---

**Note:** If you have trouble creating a filesystem with `mkfcp` on your system, you may need to use the filesystem creation utilities of the filesystem's native platform.

---

## Growing an XFS Filesystem Onto Another Disk

The procedure in this section explains how to grow an XFS filesystem onto another disk. When growing an XFS filesystem onto another disk, there are two possibilities:

- The XFS filesystem is on a disk partition.
- The XFS filesystem is on an XLV logical volume.

If the XFS filesystem is on an XLV logical volume, the additional disk can be added to the logical volume as an additional volume element. Instructions for doing this are in the section "Adding a Volume Element to a Plex (Growing an XLV Logical Volume)" in Chapter 4.

The following steps show how to grow a filesystem mounted at `/mnt` onto an XLV logical volume created out of the `/mnt` disk partition and a new disk. The procedure assumes that the new disk is installed on the system and partitioned.

---

**Caution:** All files on the additional disk are destroyed by this procedure.

---

1. Make a backup of the filesystem you are going to extend.
2. Unmount the /mnt filesystem:
3. Use `xlv_make` to create an XLV logical volume out of the /mnt partition and the new disk. The /mnt partition must be the first volume element in the data subvolume. For example:

```
# xlv_make
xlv_make> vol xlv0
xlv0
xlv_make> data
xlv0.data
xlv_make> plex
xlv0.data.0
xlv_make> ve dks0d4s7
xlv0.data.0.0
xlv_make> ve dks0d3s0
xlv0.data.0.1
xlv_make> end
Object specification completed
xlv_make> exit
Newly created objects will be written to disk.
Is this what you want?(yes) yes
Invoking xlv_assemble
```

4. Mount the /mnt filesystem:
5. Grow the XFS filesystem into the logical volume with the `xfs_growfs` command:

```
# xfs_growfs /mnt
meta-data=/mnt                isize=256    agcount=9,
agsize=2097152 blks
data      =                    bsize=512   blocks=17777424,
imaxpct=25
                    =                    sunit=0     swidth=0 blks,
unwritten=1
naming    =version 2           bsize=4096
log       =internal           bsize=512   blocks=4944
realtime  =none               extsz=65536 blocks=0, rtextents=0
data blocks changed from 17777424 to 26399727
```

6. Change the entry for `/mnt` in the file `/etc/fstab` to mount the logical volume rather than the disk partition:

```
/dev/xlv/xlv0 /mnt xfs rw,raw=/dev/rxlv/xlv0 0 0
```

Growing the filesystem is complete.

## Converting Filesystems on the System Disk From EFS to XFS

---

**Caution:** The procedure in this section can result in the loss of data if it is not performed properly. It is recommended only for experienced IRIX system administrators.

---

This section explains the procedure for converting filesystems on the system disk from EFS to XFS. Some systems have two filesystems on the system disk, the root filesystem (mounted at `/`) and the `usr` filesystem (mounted at `/usr`). Other systems have a single, combined root and `usr` filesystem mounted at `/`. This procedure covers both cases but assumes that XLV logical volumes are not used on the system disk. The basic procedure for converting a system disk is as follows:

1. Load the miniroot.
2. Do a complete dump of filesystems on the system disk.
3. Repartition the system disk if necessary.
4. Create one or two new, empty XFS filesystems.
5. Restore the files from the filesystem dumps.
6. Reboot the system.

During this procedure, you can repartition the system disk if necessary. For example, you can convert from separate root and `usr` filesystems to a single, combined filesystem, or you can resize partitions to make the root partition larger and the `usr` partition smaller. See “Disk Repartitioning” on page 131 for more information.

The early steps of this procedure ask you to identify the values of various variables, which are used later in the procedure. You may find it helpful to make a list of the variables and values for later reference. Be sure to perform only the steps that apply to your situation. Perform all steps as superuser.



---

**Caution:** It is very important to follow this procedure as documented without giving additional `inst` or shell commands. Unfortunately, deviations from this procedure, even changing to a different directory or going from the `inst` shell to an `inst` menu when not directed to do so, can have very severe consequences from which recovery is difficult.

---

1. Review “Planning an XFS Filesystem” on page 125 to verify that you are ready to begin this procedure.
2. Verify that your backups are up to date. Because this procedure temporarily removes all files from your system disk, it is important that you have a complete set of backups that have been prepared using your normal backup procedures. You will make a complete dump of the system disk starting at step 11, but you should have your usual backups in addition to the backup made during this procedure.
3. Use `devnm` to get the device name of the root disk partition, *rootpartition*. For example:

```
# devnm /
/dev/dsk/dks0d1s0 /
```

4. If the system disk has separate root and `usr` filesystems, use `devnm` to figure out the device name of the `usr` partition, *usrpartition*:

```
# devnm /usr
/dev/dsk/dks0d1s6 /usr
```

5. If you are using a tape drive as the backup device, use `hinv` to get the controller and unit numbers (*tapecntl* and *tapeunit*) of the tape drive. For example:

```
# hinv -c tape
Tape drive: unit 2 on SCSI controller 0: DAT
```

In this example, *tapecntl* is 0 and *tapeunit* is 2.

6. If you are using a disk drive as your backup device, use `df` to get the device name (*backupdevice*) and mount point (*backupfs*) of the partition that contains the filesystem where you plan to put the backup. For example:

```
# df
Filesystem                Type  blocks   use  avail %use  Mounted on
/dev/root                  efs  1992630  538378 1454252  27%  /
/dev/dsk/dks0d3s7          efs  3826812 1559740 2267072  41%  /disk3
/dev/dsk/dks0d2s7          efs  2004550    23 2004527  0%  /disk2
```

The filesystem mounted at `/disk2` has plenty of disk space for a backup of the system disk (`/` uses 538,378 blocks, and `/disk2` has 2,004,527 blocks available). The *backupdevice* for `/disk2` is `/dev/dsk/dks0d2s7` and the *backupfs* is `/disk2`.

7. Create a temporary copy of `/etc/fstab` called `/etc/fstab.xfs` and edit it with your favorite editor. For example:

```
# cp /etc/fstab /etc/fstab.xfs
# vi /etc/fstab.xfs
```

Make these changes in `/etc/fstab.xfs`:

- Replace `efs` with `xfs` in the line for the root filesystem, `/`, if there is a line for the root filesystem.
- If there is no line for the root filesystem, add this line:  

```
/dev/root    /    xfs rw,raw=/dev/rroot 0 0
```
- If `root` and `usr` are separate filesystems and will remain so, replace `efs` with `xfs` in the line for the `usr` filesystem.
- If `root` and `usr` have been separate filesystems, but the disk will be repartitioned during the conversion procedure so that they are combined, remove the line for the `usr` filesystem.

8. Shut down your workstation using the `shutdown` command or the System Shutdown item from the System Toolchest. Answer prompts as appropriate to get to the five-item System Maintenance Menu.
9. Bring up the miniroot from system software CDs or a software distribution directory.
10. Switch to the shell prompt in `inst`:

```
Inst> sh
```

11. Create a full backup of the root filesystem by giving this command:

```
# /root/sbin/dump 0uCf tapesize dumpdevice rootpartition
```

*tapesize* is the tape capacity (also used for backup to disks) and *dumpdevice* is the appropriate device name for the tape drive or the name of the file that will contain the dump image. Table 6-1 gives the values of *tapesize* and *dumpdevice* for different tape drives and disk. *tapectlr* and *tapeunit* in Table 6-1 are *tapectlr* and *tapeunit* from step 5 in this section.

**Table 6-1** dump Arguments for Filesystem Backup

| <b>Backup Device</b>        | <i>tapesize</i> | <i>dumpdevice</i>   |
|-----------------------------|-----------------|---|
| Disk                        | 2m              | Use <code>/root/backupfs/root.dump</code> for the root filesystem and <code>/root/backupfs/usr.dump</code> for the usr filesystem |
| DAT tape                    | 2m              | <code>/dev/rmt/tpstapecntlratapeunitnsv</code>  |
| DLT tape                    | 10m             | <code>/dev/rmt/tpstapecntlratapeunitnsv</code>  |
| EXABYTE 8mm model 8200 tape | 2m              | <code>/dev/rmt/tpstapecntlratapeunitnsv</code>  |
| EXABYTE 8mm model 8500 tape | 4m              | <code>/dev/rmt/tpstapecntlratapeunitnsv</code>  |
| QIC cartridge tape          | 150k            | <code>/dev/rmt/tpstapecntlratapeunitns</code>   |

12. If `usr` is a separate filesystem, insert a new tape (if you are using tape), and create a full backup of the `usr` filesystem by giving this command:

```
# /root/sbin/dump 0uCF tapesize dumpdevice usrpartition
```

*tapesize* is the tape capacity (also used for backup to disks) and *dumpdevice* is the appropriate device name for the tape drive or the name of the file that will contain the dump image. Table 6-1 gives the values of *tapesize* and *dumpdevice* for different tape drives and disk.

13. Exit out of the shell:

```
# exit
...
Inst>
```

14. If you do not need to repartition the system disk, skip to step 18.

15. To repartition the system disk, use the standalone version of `fx`. This version of `fx` is invoked from the Command Monitor, so you must bring up the Command Monitor. To do this, quit out of `inst`, reboot the system, shut down the system, then request the Command Monitor. An example of this procedure is:

```
Inst> quit
...
Ready to restart the system. Restart? { (y)es, (n)o, (sh)ell, (h)elp }: yes
...
login: root
# halt
...
System Maintenance Menu
...
Option? 5
Command Monitor. Type "exit" to return to the menu.
>>
```

On systems with a graphical System Maintenance Menu, choose the last option, Enter Command Monitor, instead of choosing option 5.

16. Boot `fx` and repartition the system disk so that it meets your needs. The following example shows how to use `fx` to switch from separate `root` and `usr` partitions to a single root partition.

```
>> boot stand/fx
84032+11488+3024+331696+26176d+4088+6240 entry: 0x89f97610
114208+29264+19536+2817088+60880d+7192+11056 entry: 0x89cd31c0
Currently in safe read-only mode.
Do you require extended mode with all options available? (no) Enter
SGI Version 6.4 ARCS   Sep 29, 1996
fx: "device-name" = (dksc) Enter
fx: ctlr# = (0) Enter
fx: drive# = (1) Enter
fx: lun# = (0) Enter
...opening dksc(0,1,0)
...drive selftest...OK
Scsi drive type == SGI      SEAGATE ST31200N8640

----- please choose one (? for help, .. to quit this menu)-----
[ex]it          [d]ebug/          [l]abel/          [a]uto
[b]adbblock/    [ex]ercise/        [r]epartition/    [f]ormat
fx> repartition/rootdrive

fx/repartition/rootdrive: type of data partition = (xfs) Enter
Warning: you will need to re-install all software and restore user data
from backups after changing the partition layout. Changing partitions
will cause all data on the drive to be lost. Be sure you have the drive
backed up if it contains any user data. Continue? yes

----- please choose one (? for help, .. to quit this menu)-----
[ex]it          [d]ebug/          [l]abel/          [a]uto
[b]adbblock/    [ex]ercise/        [r]epartition/    [f]ormat
fx> exit
```

17. Load the miniroot again, using the same procedure you used in step 9.

18. Make an XFS filesystem for root:

```
Inst> admin mkfs /dev/dsk/dks0d1s0
Unmounting device "/dev/dsk/dks0d1s0" from directory "/root".

Make new file system on /dev/dsk/dks0d1s0 [yes/no/sh/help]: yes

About to remake (mkfs) file system on: /dev/dsk/dks0d1s0
This will destroy all data on disk partition: /dev/dsk/dks0d1s0.
```

```
Are you sure? [y/n] (n): y
```

```
Block size of filesystem 512 or 4096 bytes? 4096
```

```
Doing: mkfs -b size=4096 /dev/dsk/dks0d1s0
meta-data=/dev/rdisk/dks0d1s0      isize=256      agcount=8, agsize=31021 blks
data      =                        bsize=4096    blocks=248165, imaxpact=25
          =                        sunit=0       swidth=0 blks, unwritten=1
naming    =version 1                bsize=4096
log       =internal log             bsize=4096    blocks=1168
realtime  =none                     extsz=65536   blocks=0, rtextents=0
Mounting file systems:
```

```
NOTICE: Start mounting filesystem: /root
NOTICE: Ending clean XFS mount for filesystem: /root
/dev/miniroot      on /
/dev/dsk/dks0d1s0  on /root
```

```
Re-initializing installation history database
Reading installation history .. 100% Done.
Checking dependencies .. 100% Done.
```

19. Switch to the shell prompt in inst:

```
Inst> sh
```

20. If you made the backup on disk, create a mount point for the filesystem that contains the backup and mount it:

```
# mkdir /backupfs
# mount backupdevice /backupfs
```

21. If you made the backup on tape, restore all files on the root filesystem from the backup you made in step 11 by putting the correct tape in the tape drive and giving these commands:

```
# cd /root
# mt -t /dev/rmt/tpstapecntlrdtapeunit rewind
# restore rf dumpdevice
```

You may need to be patient while the restore is taking place; it normally does not generate any output and it can take a while.

22. If you made the backup on disk, restore all files on the root filesystem from the backup you made in step 11 by giving these commands:

```
# cd /root
# restore rf /backupfs/root.dump
```

23. If you made a backup of the `usr` filesystem in step 12 on tape, restore all files in the backup by putting the correct tape in the tape drive and giving these commands:

```
# cd /root/usr
# mt -t /dev/rmt/tpstapectlrdrdtapeunit rewind
# restore rf dumpdevice
```

24. If you made a backup of the `usr` filesystem in step 12 on disk, restore all files in the backup by giving these commands:

```
# cd /root/usr
# restore rf /backupfs/usr.dump
```

25. Move the new version of `/etc/fstab` that you created in step 7 into place (the first command, which is optional, saves the old version of `/etc/fstab`):

```
# mv /root/etc/fstab /root/etc/fstab.old
# mv /root/etc/fstab.xfs /root/etc/fstab
```

26. Exit from the shell and `inst` and restart the system:

```
# exit
#
Calculating sizes .. 100% Done.

Inst> quit
...
Ready to restart the system. Restart? { (y)es, (n)o, (sh)ell, (h)elp }: yes
Preparing to restart system ...

The system is being restarted.
```

## Converting a Filesystem on an Option Disk From EFS to XFS

---

**Caution:** The procedure in this section can result in the loss of data if it is not performed properly. It is recommended only for experienced IRIX system administrators.

---

This section explains how to convert an EFS filesystem on an option disk (a disk other than the system disk) to XFS. It assumes that XLV logical volumes are not used. You must be superuser to perform this procedure.

1. Review “Planning an XFS Filesystem” on page 125 to verify that you are ready to begin this procedure.
2. Verify that your backups are up to date. Because this procedure temporarily removes all files from the filesystem you convert, it is important that you have a complete set of backups that have been prepared using your normal backup procedures. You will make a complete backup of the system disk in step 4, but you should have your usual backups in addition to the backup made during this procedure.
3. Identify the device name of the partition, which is the variable *partition*, where you plan to create the filesystem. For example, if you plan to use partition 7 (the entire disk) of an option disk on controller 0 and drive address 2, *partition* is `/dev/dsk/dks0d2s7`. For more information on determining *partition* (also known as a *special* file), see the `dks(7M)` reference page.
4. Back up all files on the disk partition to tape or disk because they will be destroyed by the conversion process. You can use any backup command (`Backup`, `bruo`, `cpio`, `tar`, and so on) and back up to a local or remote tape drive or a local or remote disk. For example, the command for `dump` for local tape is:

```
# dump 0u Cf tapesize dumpdevice partition
```

*tapesize* is the tape capacity (also used for backup to disks) and *dumpdevice* is the device name for the tape drive. Table 6-1 gives the values of *tapesize* and *dumpdevice* for different local tape drives and disk. You can get the values of *tapecntlr* and *tapeunit* used in the table from the output of the command `hinvt -c tape`.

5. Unmount the partition:

```
# umount partition
```



6. Use the `mkfs` command to create the new XFS filesystem:

```
# mkfs -b size=blocksize -l size=logsize partition
```

*blocksize* is the filesystem block size (see “Choosing the Filesystem Block Size and Extent Size” on page 126), and *logsize* is the size of the area dedicated to log records (see “Choosing the Log Type and Size” on page 128). Example 6-2 shows an example of this command line and its output.

7. Mount the new filesystem with this command:

```
# mount partition mountdir
```

8. In the file `/etc/fstab`, in the entry for *partition*, replace `efs` with `xfs`. For example:

```
partition mountdir xfs rw,raw=rawpartition 0 0
```

*rawpartition* is the raw version of *partition*.

9. Restore the files to the filesystem from the backup you made in step 4. For example, if you gave the `dump` command in step 4, the commands to restore the files from tape are:

```
# cd mountdir
# mt -t device rewind
# restore rf dumpdevice
```

The value of *device* is the same as *dumpdevice* without `nsv` or other letters at the end.

You may need to be patient while the restore is taking place; it does not generate any output and it can take a while.

## Checking for Adequate Free Disk Space When Converting to XFS Filesystems

XFS filesystems may require more disk space than EFS filesystems for the same files. This extra disk space is required to accommodate the XFS log and as a result of block sizes larger than EFS’s 512 bytes. However, XFS represents free space more compactly, on average, and the inodes are allocated dynamically by XFS, which can result in less disk space usage.

Use the following procedure to get a rough idea of how much free disk space will remain after a filesystem is converted to XFS:

1. Get the size in kilobytes of the filesystem to be converted and round the result to the next megabyte. For example:

```
df -k
Filesystem                Type  kbytes    use   avail %use  Mounted on
/dev/root                  efs   969857  663306  306551  68%  /
```

This filesystem is 969857 KB, which rounds up to 970 MB.

2. If you plan to use an internal log (see “Choosing the Log Type and Size” on page 128), enter this command to get an estimate of the disk space required for the files in the filesystem after conversion:

```
% xfs_estimate -i logsize -b blocksize mountpoint
```

*logsize* is the size of the log. *blocksize* is the block size you chose for user files in “Choosing the Filesystem Block Size and Extent Size” on page 126. *mountpoint* is the directory that is the mount point for the filesystem. For example:

```
% xfs_estimate -i 1m -b 4096 /
/ will take about 747 megabytes
```

The output of this command tells you how much disk space the files in the filesystem (with a *blocksize* of 4096 bytes) and an internal log of size *logsize* will take after conversion to XFS.

3. If you plan to use an external log, give this command to get an estimate of the disk space required for the files in the filesystem after conversion:

```
% xfs_estimate -e 0 -b blocksize mountpoint
```

*blocksize* is the block size you chose for user files in the section “Choosing the Filesystem Block Size and Extent Size” on page 126. *mountpoint* is the directory that is the mount point for the filesystem. For example,

```
% xfs_estimate -e 0 -b 4096 /
/ will take about 746 megabytes
      with the external log using 0 blocks or about 1 megabytes
```

The first line of output from `xfs_estimate` tells you how much disk space the files in the filesystem will take after conversion to XFS. In addition to this, you need disk space on a different disk partition for the external log. Ignore the second line of output.

4. Compare the size of the filesystem from step 1 with the size of the files from step 2 or step 3. For example:

```
970 MB - 747 MB = 223 MB free disk space
747 MB / 970 MB = 77% full
```

Use this information to decide if there will be an adequate amount of free disk space if this filesystem is converted to XFS.

If the amount of free disk space after conversion is not adequate, consider these options:

- Implement the usual solutions for inadequate disk space: remove unnecessary files, archive files to tape, move files to another filesystem, add another disk, and so on.
- Repartition the disk to increase size of the disk partition for the filesystem.
- If there is not sufficient disk space in the root filesystem and you have separate root and `usr` filesystems, switch to combined root and `usr` filesystems on a single disk partition.
- If the filesystem is on an XLV logical volume, increase the size of the volume.
- Create an XLV logical volume with a log subvolume elsewhere, so that all of the disk space can be allocated for user files.

## Dump and Restore Requirements When Converting to XFS Filesystems

The filesystem conversion procedures in “Converting Filesystems on the System Disk From EFS to XFS” on page 140 and “Converting a Filesystem on an Option Disk From EFS to XFS” on page 148 require that you dump the filesystems you plan to convert to tape or to another disk with sufficient free disk space to contain the dump image. Dumping to disk is substantially faster than dumping to tape.

When you convert a system disk, you must use the `dump` and `restore` commands. When you convert a filesystem on an option disk, you can use any backup and restore commands.

If you dump to a tape drive, follow these guidelines:

- Have sufficient tapes available for dumping the filesystems to be converted.
- If you are converting filesystems on a system disk, the tape drive must be local.
- If you are converting filesystems on option disks, the tape drive can be local or remote.

The requirements for dumping to a different filesystem are:

- The filesystem being converted must have 2 GB or less in use (the maximum size of the dump image file on an EFS filesystem) unless it is being dumped to an XFS filesystem.
- The filesystem that will contain the dump must have sufficient disk space available to hold the filesystems to be converted.
- If you are converting filesystems on a system disk, the filesystem where you place the dump must be local to the system.
- If you are converting filesystems on option disks, the filesystem you dump to can be local or remote.

## Maintaining Filesystems

This chapter describes administration procedures for maintaining XFS filesystems that you perform on a routine or as-needed basis. It is extremely important to maintain filesystems properly, in addition to backing up the data they contain. Failure to do so might result in loss of valuable system and user information.

The major sections in this chapter are:

- “Routine Filesystem Administration Tasks” on page 153
- “Mounting and Unmounting Filesystems” on page 154
- “Managing Disk Space” on page 158
- “Copying XFS Filesystems With `xfs_copy`” on page 176
- “Checking XFS Filesystem Consistency With `xfs_check` and `xfs_repair`” on page 176
- “Checking Foreign Filesystem Consistency With `fpck`” on page 180
- “Repairing XFS Filesystem Problems” on page 180
- “Running `xfs_repair` on the Root Filesystem” on page 184

### Routine Filesystem Administration Tasks

To administer filesystems, you need to do the following:

- Monitor the amount of free space and free inodes available.
- If a filesystem is chronically short of free space, take steps to alleviate the problem, such as removing old files and imposing disk usage quotas.
- Back up filesystems.

Many routine administration jobs can be performed by shell scripts. Here are a few ideas:

- Use a shell script to investigate free blocks and free inodes, and report on filesystems whose free space dips below a given threshold.
- Use a shell script to automatically “clean up” files that grow (such as log files).
- Use a shell script to highlight cases of excessive disk use.

These scripts can be run automatically with the `crontab` command and the output can be sent to you using electronic mail. Typically, these scripts use some combination of the `find`, `du`, `mail`, and shell commands.

The process accounting system performs many similar functions. If the process accounting system does not meet your needs, examine the scripts in `/usr/lib/acct`, such as `ckpacct` and `remove`, for ideas about how to build your own administration scripts.

## Mounting and Unmounting Filesystems

As explained in “Filesystem Mounting and Unmounting” in Chapter 5, in order to be accessed by IRIX, filesystems must be mounted. The following subsections explain the use of the `mount` and `umount` commands and the file `/etc/fstab` to mount and unmount filesystems.

### Manually Mounting Filesystems

The `mount` command is used to mount filesystems manually. The basic forms of the `mount` command are:

```
mount device_file mount_point_directory
mount host:directory mount_point_directory
```

*device\_file* is a block device file. *host:directory* is the hostname and pathname of a remote directory that has been exported on the remote host by using the `exportfs` command on the remote host (it requires NFS). *mount\_point\_directory* is the mount point directory. The mount point must already exist (you can create it with the `mkdir` command).

If you omit either the *device\_file* or the *mount\_point\_directory* from the `mount` command line, `mount` checks the file `/etc/fstab` to find the missing argument. See “Mounting

Filesystems Automatically With the `/etc/fstab` File” on page 155 for more information about `/etc/fstab`.

For example, to mount a filesystem manually, use this command:

```
mount /dev/dsk/dks0d1s6 /usr
```

Another example, which uses a mnemonic device file name, is:

```
mount /dev/usr /usr
```

An example of a `mount` command for a filesystem that is listed in `/etc/fstab` is:

```
mount /d2
```

Other useful `mount` commands are:

```
mount -a      Mount all filesystems listed in /etc/fstab.
```

```
mount -h host
              Mount all filesystems listed in /etc/fstab that are remote-mounted
              from the system named host.
```

```
mount -o quota device_file mount_point_directory
              Mount the filesystem device_file at mount_point_directory with disk quota
              tracking turned on. See “Using Disk Quotas on XFS Filesystems” on
              page 169 for more information.
```

You can use the `-t type` option of the `mount` command to specify what type of filesystem you are mounting. For a description of the filesystem types that the IRIX operating system supports, see the `filesystems(4)` reference page.

See the `mount(1M)` reference page for more information about the `mount` command.

## Mounting Filesystems Automatically With the `/etc/fstab` File

The `/etc/fstab` file contains information about every filesystem and swap partition that is to be mounted automatically when the system is booted into multi-user mode. In addition, the `/etc/fstab` file is used by the `mount` command when only the device block file or the mount point is given to the `mount` command. Filesystems that are not

mounted with the `mount` command, such as the `/proc` filesystem, are not listed in `/etc/fstab`.

The procedure in this section explains how to add an entry for a filesystem to `/etc/fstab`.

For each filesystem that is to be mounted every time the system is booted, a line similar to this appears in the file `/etc/fstab`:

```
/dev/dsk/dks0d2s7 /test xfs rw,raw=/dev/rdisk/dks0d2s7 0 0
```

The fields in this line are defined as follows:

|                                |   |
|--------------------------------|---|
| <code>/dev/dsk/dks0d2s7</code> | The block device file of the partition where the filesystem is located.   |
| <code>/test</code>             | The name of the directory where the filesystem will be mounted (the mount point).   |
| <code>xfs</code>               | The type of filesystem. In this case, the filesystem is an XFS filesystem.  |
| <code>rw, raw=</code>          | These are some of many options available when mounting a filesystem (see the <code>fstab(4)</code> reference page for a complete list). In this instance, the filesystem is to be mounted read-write, so that <code>root</code> and other users can write to it. The <code>raw=</code> option gives the filesystem's raw device filename. It should be the last option in the options list. |
| <code>0 0</code>               | These two numbers represent the frequency of dump cycles and the <code>fsck</code> pass priority. These two numbers must be added after the last option in the options list ( <code>raw=</code> ). The <code>fstab(4)</code> reference page contains additional information.  |

If you have already mounted the filesystem as described in the section “Manually Mounting Filesystems” on page 154, you can use the `mount` command to determine the appropriate `/etc/fstab` entry. For example:

```
mount -p
```

This command displays all currently mounted filesystems, including the new filesystem in `/etc/fstab` format. Copy the line that describes the new filesystem to `/etc/fstab`.

The `mount` command reads `/etc/fstab` sequentially; therefore, filesystems that are mounted beneath other filesystems must follow their parent partitions in `/etc/fstab` in order for their mount points to exist.



The swap partition on the system disk (partition 1) is not listed in `/etc/fstab`. However, additional swap partitions added to the system are listed. For swap partitions, the mount point field is not used. See the guide and the `swap(1M)` reference page for more information.

See the `fstab(4)` reference page for more information about `/etc/fstab` entries.

## Mounting a Remote Filesystem Automatically

If you have the optional NFS software, you can automatically mount any remote filesystem whenever it is accessed (for example, by changing directories to the filesystem with `cd`). The remote filesystem must be exported with the `exportfs` command.

For complete information about setting up automounting, including all the available options, see the `automount(1M)` and `exportfs(1M)` reference pages. These commands are discussed more completely in the *ONC3/NFS Administrator's Guide*.

## Unmounting Filesystems

Filesystems are automatically unmounted when the system is shut down. To manually unmount filesystems, use the `umount` command. The three basic forms of the command are shown in Table 7-1. Local filesystems can be unmounted with either of the first two forms shown in the table; they are equivalent. Similarly, the first and third forms are equivalent for remote filesystems.

**Table 7-1** Forms of the `umount` Command

| Command                                   | Comments  |
|---|---|
| <code>umount mount_point_directory</code> | <code>mount_point_directory</code> is a directory pathname that is the mount point for the filesystem. This form can be used for local or remote filesystems. |
| <code>umount device_file</code>           | <code>device_file</code> is a block device file name. This form is only for local filesystems.  |

**Table 7-1** Forms of the `umount` Command (continued)

| Command                            | Comments   |
|------------------------------------|--|
| <code>umount host:directory</code> | <i>host:directory</i> is a remote directory. This form is only for remote filesystems.   |
| <code>umount -a</code>             | Attempt to unmount all the filesystems currently mounted (listed in <code>/etc/mtab</code> ) except <code>/</code> and <code>/usr</code> . This command is not the complement of the <code>mount -a</code> command, which mounts all filesystems listed in <code>/etc/fstab</code> . |

For example, to unmount a local or remote filesystem mounted at `/d2`, give this command:

```
umount /d2
```

To unmount the filesystem on the partition `/dev/dsk/dks0d1s7`, give this command:

```
umount /dev/dsk/dks0d1s7
```

To unmount the remote-mounted (NFS) filesystem `depot:/usr/spool/news`, give this command:

```
umount depot:/usr/spool/news
```

To be unmounted, a filesystem must not be in use. If it is in use and you try to unmount it, you get a `Resource busy` message. Error messages and their solutions are explained in the `umount(1M)` reference page.

## Managing Disk Space

At some point, you are likely to find yourself short on disk space. In addition to using disk space intentionally for new files, you and other users may be creating and retaining files that you do not need.

- People tend to forget about files they no longer use. Outdated files often stay on the system much longer than necessary.
- Some files, particularly log files such as `/var/adm/SYSLOG`, grow as a result of normal system operations. Normally, `cron` rotates this file once per week so that it

does not grow excessively large. (See `/var/spool/cron/crontabs/root`.) However, you should check this file periodically to make sure it is being rotated properly, or when the amount of free disk space has grown small.

- Some directories, notably `/tmp`, `/usr/tmp`, and `/var/tmp`, accumulate files. These are often copies of files being manipulated by text editors and other programs. Sometimes these temporary files are not removed by the programs that created them.
- The directories `/usr/tmp`, `/var/tmp`, and `/var/spool/uucppublic` are public directories; people often use them to store temporary copies of files they are transferring to and from other systems and sites. Unlike `/tmp`, they are not cleaned out when the system is rebooted. The site administrator should be even more conscientious about monitoring disk use in these directories.
- Users move old files to the dumpster without realizing that such files are not fully deleted from the system.
- `vmcore` and `unix` files in `/var/adm/crash` are accumulating without being removed.
- Binary core dumps, `core` files, from crashed application programs are not being removed.

---

**Tip:** The section “Freeing Disk Space” in Chapter 6 of the *Personal System Administration Guide* provides additional ideas for identifying unnecessary files.

---

The following subsections describe various techniques for monitoring disk space usage, locating unneeded files, and limiting disk usage by individual users.

## Monitoring Free Space and Free Inodes

You can quickly check the amount of free space and free inodes with the `df` command. For example,

```
% df
Filesystem                Type  blocks   use  avail %use  Mounted on
/dev/root                  xfs  1939714 1326891  612823  68%  /
```

The `avail` column shows the amount of free space in blocks.

To determine the number of free inodes, use this command:

```
% df -i
Filesystem      Type  blocks   use   avail %use    iuse  ifree %iuse  Mounted
/dev/root       xfs  1939714 1326891 612823 68%   14491 195031 7%  /
```

You see a listing similar to the first `df` listing, except that it also lists the number of inodes in use, the number of inodes that are free (available), and the percentage of inodes in use. For XFS filesystems, the number of free inodes is the maximum number that could be allocated if needed. XFS allocates inodes as needed. On XFS filesystems inode usage is very high only on very full filesystems. XFS filesystem performance does not degrade when XFS filesystems are very full.

## Monitoring Key Files and Directories

Almost any system that is used daily has several key files and directories that grow through normal use. Some examples are shown in Table 7-2.

**Table 7-2** Files and Directories That Tend to Grow

| File                                  | Use   |
|---------------------------------------|---|
| <code>/etc/wtmp</code>                | History of system logins  |
| <code>/tmp</code>                     | Directory for temporary files (root filesystem)   |
| <code>/var/adm/avail/availlog</code>  | Log file for the availability monitor (see the <code>availmon(5)</code> reference page) |
| <code>/var/adm/avail/notifylog</code> | Log file for the availability monitor (see the <code>availmon(5)</code> reference page) |
| <code>/var/adm/sulog</code>           | History of <code>su</code> commands   |
| <code>/var/cron/log</code>            | History of actions of <code>cron</code>   |
| <code>/var/spool/lp/log</code>        | History of actions of <code>lp</code>   |
| <code>/var/spool/uucp</code>          | Directory for <code>uucp</code> log files   |
| <code>/var/tmp</code>                 | Directory for temporary files   |

The frequency with which you should check growing files depends on how active your system is and how critical the disk space problem is. A good technique for keeping them down to a reasonable size uses a combination of the `tail` and `mv` commands:

```
# tail -50 /var/adm/sulog > /var/tmp/sulog
# mv /var/tmp/sulog /var/adm/sulog
```

This sequence puts the last 50 lines of `/var/adm/sulog` into a temporary file, then moves the temporary file to `/var/adm/sulog`. This reduces the file to the 50 most recent entries. It is often useful to have these commands performed automatically every week using `cron`. For more information on using `cron` to automate your regular tasks, see the `cron(1M)` reference page.

## Cleaning Out Temporary Directories

The directory `/tmp` and all of its subdirectories are automatically cleaned out every time the system is rebooted. You can control whether or not this happens with the `chkconfig` option `nocleantmp`. By default, `nocleantmp` is off, and thus `/tmp` is cleaned.

The directory `/var/tmp` is not automatically cleaned out when the system is rebooted. This is a fairly standard practice on IRIX systems. If you wish, you can configure IRIX to clean out `/var/tmp` automatically whenever the system is rebooted. Changing this standard policy is a fairly extreme measure, and many people expect that files left in `/var/tmp` are not removed when the system is rebooted. Do not make this change without warning users well in advance.

To configure IRIX to clean out `/var/tmp` automatically at system reboot, follow these steps:

1. Notify everyone who uses the system that you are changing the standard policy regarding `/var/tmp`, and that all files left in `/var/tmp` will be removed when the system is rebooted. Send electronic mail and post a message in the `/etc/motd` file.

Give the users at least one week's notice, longer if possible.

2. Copy the file `/etc/init.d/rmtmpfiles` to a new file in the same directory, for example, `/etc/init.d/rmtmpfiles2`:

```
# cd /etc/init.d
# cp rmtmpfiles rmtmpfiles2
```

3. Open `rmtmpfiles2` for editing, for example:

```
# vi rmtmpfiles2
```

4. Find a block of commands in the file that looks something like this:

```
# make /var/tmp exist
if [ ! -d /var/tmp ]
then
    rm -f /var/tmp # remove the directory
    mkdir /var/tmp
fi
```

5. Before the `fi` statement add the following lines:

```
else
    # clean out /var/tmp
    rm -f /var/tmp/*
```

The complete block of commands should look something like this:

```
# make /var/tmp exist
if [ ! -d /var/tmp ]
then
    rm -f /var/tmp # remove the directory
    mkdir /var/tmp
else
    # clean out /var/tmp
    rm -f /var/tmp/*
fi
```

6. Save the file and exit the editor.
7. Create a link to the new file in the directory `/etc/rc2.d`, following the naming conventions described in `/etc/init.d/README`. For example:

```
# cd ../rc2.d
# ln -s ../init.d/rmtmpfiles S59rmtmpfiles2
```

## Locating Unused Files

Part of the job of cleaning up filesystems is locating and removing files that have not been used recently. The `find` command can locate files that have not been accessed recently.

The `find` command searches for files, starting at a directory named on the command line. It looks for files that match whatever criteria you wish, for example all regular files, all files that end in `.trash`, or any file older than a particular date. When it finds a file that matches the criteria, it performs whatever task you specify, such as removing the file, printing the name of the file, changing the file's permissions, and so forth.

For example:

```
# find /usr -local -type f -mtime +60 -print > /usr/tmp/deadfiles &
```

In the above example:

|                        |   |
|------------------------|---|
| /usr                   | specifies the pathname where <code>find</code> is to start.   |
| -local                 | restricts the search to files on the local system.  |
| -type f                | tells <code>find</code> to look only for regular files and to ignore special files, directories, and pipes.   |
| -mtime +60             | says you are interested only in files that have not been modified in 60 days.   |
| -print                 | means that when a file is found that matches the <code>-type</code> and <code>-mtime</code> expressions, you want the pathname to be printed.   |
| > /usr/tmp/deadfiles & | directs the output to the temporary file <code>/usr/tmp/deadfiles</code> and runs in the background. Redirecting the results of the search in a file is a good idea if you expect a large amount of output. |

As another example, you can use the `find` command to find files over 7 days old in the temporary directories and remove them. Use the following commands:

```
# find /var/tmp -local -type f -atime 7 -exec rm {} \;
# find /tmp -local -type f -atime 7 -exec rm {} \;
```

This example shows how to use `find` to locate and remove all core files over a week old:

```
# find / -local -type f -name core -atime +7 -exec rm {} \;
```

See the `cron(1M)` reference page for information on using the `cron` command to automate the process of locating and possibly removing.

## Identifying Accounts That Use Large Amounts of Disk Space

A number of commands are useful for tracking down accounts that use large amounts of space: `du`, `find`, `quota` commands, and `diskusg`. Their use is described in the following subsections.

## Checking Disk Space Usage With du

du displays disk use, in blocks, for files and directories. For example:

```
# du /usr/share/catman/u_man
5      /usr/share/catman/u_man/cat1/audio
266    /usr/share/catman/u_man/cat1/Xm
1956   /usr/share/catman/u_man/cat1/Xl1
72     /usr/share/catman/u_man/cat1/Inventor
413    /usr/share/catman/u_man/cat1/dmedia
752    /usr/share/catman/u_man/cat1/explorer
12714  /usr/share/catman/u_man/cat1
1      /usr/share/catman/u_man/cat3/audio
63     /usr/share/catman/u_man/cat3
12     /usr/share/catman/u_man/cat6/video
1077   /usr/share/catman/u_man/cat6
92     /usr/share/catman/u_man/cat2
425    /usr/share/catman/u_man/cat4
170    /usr/share/catman/u_man/cat5
13     /usr/share/catman/u_man/cat1m
14557  /usr/share/catman/u_man
```

This displays the block count for all directories in the directory `/usr/share/catman/u_man`. By default the `du` command displays disk use in 512-byte blocks. To display disk use in 1024-byte blocks, use the `-k` option. For example:

```
# du -k /usr/people/ralph
```

The `-s` option produces a summary of the disk use in a particular directory. For example:

```
# du -s /usr/people/alice
```

For a complete description of `du` and its options, see the `du(1M)` reference page.

## Checking Disk Space Usage With find

Use `find` to locate specific files that exceed a given size limit. For example:

```
# find /usr -local -type f -size +10000 -print
```

This example produces a display of the pathnames of all files in the `usr` filesystem that are larger than 10,000 512-byte blocks.



## Monitoring Disk Space Usage with Disk Quota Accounting

The disk quotas system, described in the section “Disk Quotas” in Chapter 5, can be used to monitor disk space usage without enforcing disk usage limits. Disk quota accounting can be enabled by user, by group, or by project. Disk quota accounting by user and disk quota accounting by group are mutually exclusive.

On XFS filesystems, use these commands to turn on disk usage accounting without enforcement, stop disk usage accounting, and report disk space usage:

- To turn on disk usage accounting automatically on a filesystem for user quotas, include the option `qnoenforce` in the `/etc/fstab` entry, for example:

```
/dev/xlv/myfs /myfs xfs rw,qnoenforce,raw=/dev/rxlv/myfs 0 0
```

To turn on disk usage accounting automatically on a filesystem for group quotas, include the option `gqnoenforce` in the `/etc/fstab` entry, for example:

```
/dev/xlv/myfs /myfs xfs rw,gqnoenforce,raw=/dev/rxlv/myfs 0 0
```

To turn on disk usage accounting automatically on a filesystem for project quotas, include the option `pqnoenforce` in the `/etc/fstab` entry, for example:

```
/dev/xlv/myfs /myfs xfs rw,pqnoenforce,raw=/dev/rxlv/myfs 0 0
```

- To turn on disk usage accounting manually for user quotas on a non-root filesystem, when mounting the filesystem, use this `mount` command:

```
# mount -o qnoenforce fsname rootdir
```

*fsname* is the device name of the filesystem. *rootdir* is the directory where the filesystem is mounted.

To turn on disk usage accounting manually on a non-root filesystem for group quotas when mounting the filesystem, use this `mount` command:

```
# mount -o gqnoenforce fsname rootdir
```

To turn on disk usage accounting manually on a non-root filesystem for project quotas when mounting the filesystem, use this `mount` command:

```
# mount -o pqnoenforce fsname rootdir
```

- To turn on disk usage accounting manually on the root filesystem for user quotas, execute the following commands. The `quotaon` command turns on disk accounting with enforcement, and the `quotaoff -o` command turns off the enforcement.

```
# /usr/etc/quotaon -v /
# /usr/etc/quotaoff -v -o enforce /
# reboot
```

To turn on disk usage accounting manually on the root filesystem for group quotas, give these commands:

```
# /usr/etc/quotaoon -v -o gquota /
# /usr/etc/quotaoff -v -o ggenforce /
# reboot
```

To turn on disk usage accounting manually on the root filesystem for project quotas, give these commands:

```
# /usr/etc/quotaoon -v -o pquota /
# /usr/etc/quotaoff -v -o pgenforce /
# reboot
```

- To stop disk usage accounting on a filesystem for user quotas, give this command:

```
# /usr/etc/quotaoff fsname
```

To stop disk usage accounting on a filesystem for group quotas, give this command:

```
# /usr/etc/quotaoff -o gquota fsname
```

To stop disk usage accounting on a filesystem for project quotas, give this command:

```
# /usr/etc/quotaoff -o pquota fsname
```

- To get information about disk usage, use the commands described in “Checking Disk Space Usage With quot” on page 166 and “Checking Disk Space Usage on XFS Filesystems With quota” on page 167.

## Checking Disk Space Usage With quot

The `quot` command reports the amount of disk usage per user on a filesystem. It is part of the disk quotas system, although you need not use quotas to use this command. On XFS filesystems, you must turn on user quotas even if you don’t enforce the limits; for instructions see “Monitoring Disk Space Usage with Disk Quota Accounting” on page 165.

You can use the output of the `quot` command to inform your users of their disk space usage. An example of the command that displays disk space usage (on the root filesystem in this example), is:

```
# /usr/etc/quot /
/dev/root (/):
 371179    root
 265712    ellis
 12606     aevans
```

```

7927  demos
5526  bin
2744  lp
682   uucp
379   guest
207   adm
7     sys

```

### Checking Disk Space Usage on XFS Filesystems With `quota`

The `quota` command reports the amount of disk usage per user, per group, or per project on a filesystem, as well as additional information about the disk quotas. On XFS filesystems, you must turn on quotas to use this feature, even if you are not going to enforce quota limits. For instructions on monitoring disk space usage without enforcing disk usage limits see “Monitoring Disk Space Usage with Disk Quota Accounting” on page 165.

For information on the output of the `quota` command, see “Displaying Disk Quota Information on XFS Filesystems” on page 173.

### Checking Disk Space Usage With `diskusg`

The `diskusg` command is part of the process accounting subsystem and serves the same purpose as `quot`. `diskusg`, however, is typically used as part of general system accounting. This command generates disk usage information on a per-user basis. For example,

```

# /usr/lib/acct/diskusg /dev/root
0      root      736795
2      bin       11035
3      uucp      1342
4      sys       9
5      adm       1011
9      lp        5418
126    ellis     528263
993    demos    15737
998    guest     740
5315   aevans   24836

```

`diskusg` prints one line for each user identified in the `/etc/passwd` file. Each line contains the user’s UID number and login name, and the total number of 512-byte blocks of disk space currently being used by the account.

The output of `diskusg` is normally the input to `acctdisk` (see the `acct(1M)` reference page), which generates total disk accounting records that can be merged with other accounting records. For more information on the accounting subsystem, consult *IRIX Admin: Backup, Security, and Accounting* and the `acct(4)` reference page.

## Running Out of Space in the Root Filesystem

For systems that have separate root and `usr` filesystems, running out of disk space on the root filesystem can occur for several reasons:

- New software options that place files in the root filesystem have been installed.
- A new IRIX release that requires more disk space in the root filesystem has been installed.
- Files created while filesystems were unmounted have been unintentionally placed in the root filesystem instead of their intended filesystem. For example, suppose that the `usr` filesystem is unmounted and the file `/usr/tempfile` is created. When the `usr` filesystem is mounted at `/usr`, the file `/usr/tempfile` is not accessible, but it is still using disk space.
- Applications that create files in `/tmp` are creating many files or very large files that fill up the root filesystem.

You can pursue several possible courses of action when the root filesystem is too full:

- Check for hidden files. Unmount filesystems other than the root filesystem (you may find this easiest to do from the `miniroot`) and list the contents of each of the mount point directories.
- Check the `/lost+found` directory. You may find that large files have accumulated there.
- Increase the size of the root filesystem by combining the root and `usr` filesystems or by making the root filesystem larger by taking disk space from the `usr` filesystem.
- Identify applications that are creating files in `/tmp` and cause the most problems, and configure them to use `/usr/tmp` instead of `/tmp` for temporary files. Most applications recognize the `TMPDIR` environment variable, which specifies the directory to use instead of the default. For example, with `ssh`:

```
% setenv TMPDIR /usr/tmp
```

With `sh`:

```
% TMPDIR=/usr/tmp ; export TMPDIR
```

- Make `/tmp` a mounted filesystem. (See “Mount a Filesystem as a Subdirectory” in Chapter 5.) You can “carve” a `/tmp` filesystem out of other filesystems if necessary.

## Using Disk Quotas on XFS Filesystems

This section describes basic commands for administering disk quotas on XFS filesystems. Additional commands are described on the `quota(1)`, `edquota(1M)`, `quot(1M)`, and `repquota(1M)` reference pages.

You can set disk quotas for individual users, you can set disk quotas for groups according to group ID, and you can set disk quotas for projects, according to project ID. For information on group and project IDs and how they are established, see *IRIX Admin: Backup, Security, and Accounting*. Use of disk quota limits for groups and use of disk quota limits for projects are mutually exclusive.

For XFS filesystems, you must first turn on disk quotas on a filesystem, then set quotas on that filesystem for users and projects or groups.

### Turning on Disk Quotas for Users on XFS Filesystems

You can turn on quotas for users in these ways:

- To turn on disk quotas automatically for users on a filesystem, include the option `quota` in the `/etc/fstab` entry, for example:

```
/dev/xlv/myfs /myfs xfs rw,quota,raw=/dev/rxlv/myfs 0 0
```

- To turn on disk quotas manually for users on a non-root filesystem, mount the filesystem with this command:

```
# mount -o quota fsname rootdir
```

*fsname* is the device name of the filesystem. *rootdir* is the directory where the filesystem is mounted.

- To turn on disk quotas manually for users on the root filesystem, give these commands:

```
# /usr/etc/quotaoon -v /
# reboot
```

## Turning on Disk Quotas for Groups on XFS Filesystems

You can turn on quotas for groups in these ways:

- To turn on disk quotas automatically for groups on a filesystem, include the option `gquota` in the `/etc/fstab` entry, for example:

```
/dev/xlv/myfs /myfs xfs rw,gquota,raw=/dev/rxlv/myfs 0 0
```

- To turn on disk quotas manually for groups on a non-root filesystem, mount the filesystem with this command:

```
# mount -o gquota fsname rootdir
```

*fsname* is the device name of the filesystem. *rootdir* is the directory where the filesystem is mounted.

- To turn on disk quotas manually for groups on the root filesystem, give these commands:

```
# /usr/etc/quotaoon -o gquota -v /  
# reboot
```

Use of disk quota limits for groups and use of disk quota limits for projects are mutually exclusive.

## Turning on Disk Quotas for Projects on XFS Filesystems

You can turn on quotas for projects in these ways:

- To turn on disk quotas automatically for projects on a filesystem, include the option `pquota` in the `/etc/fstab` entry, for example:

```
/dev/xlv/myfs /myfs xfs rw,pquota,raw=/dev/rxlv/myfs 0 0
```

- To turn on disk quotas manually for projects on a non-root filesystem, mount the filesystem with this command:

```
# mount -o pquota fsname rootdir
```

*fsname* is the device name of the filesystem. *rootdir* is the directory where the filesystem is mounted.

- To turn on disk quotas manually for projects on the root filesystem, give these commands:

```
# /usr/etc/quotaoon -o pquota -v /  
# reboot
```

Use of disk quota limits for groups and use of disk quota limits for projects are mutually exclusive.

### Setting Disk Quota Limits for Users on XFS Filesystems

After turning on disk quotas on a filesystem, you can set limits for users on that filesystem using the commands below. You can preview the results of each of these commands by adding a `-n` option, which is the dry-run option.

- To specify limits for users interactively, give this command:

```
# /usr/etc/edquota name ...
```

*name* is a user name or numeric user ID. The screen clears, and you are placed in the editor specified by the EDITOR environment variable (`vi` if `$EDITOR` is not set) to edit the disk quotas for the filesystem mounted at *rootdir* for the first *user* listed on the command line. You see:

```
fs rootdir kbytes (soft = 0, hard = 0) inodes (soft = 0, hard = 0)
```

The first pair of soft and hard numbers are the soft and hard limits for disk usage in kilobytes in the filesystem at *rootdir*. The second pair of soft and hard numbers are the soft and hard limits for the number of files that *user* can own in the filesystem.

Edit the zeros to set the limits to sizes you choose. A limit of zero is not enforced.

After you set the limits, save the file and quit the editor. If you specified more than one *user* on the command line, another instance of the editor appears with the line above. Edit this line to enter the limits for the second *user*. Continue until lines have been edited for all *users*.

- To specify that users are to have the same limits as another user (*proto\_name*), enter this command:

```
# /usr/etc/edquota -p proto_name name ...
```

- To specify limits for a user non-interactively, enter this command:

```
# /usr/etc/edquota -f rootdir -l \  
uid=userid,bsoft=kvalue,bhard=kvalue,isoft=value,ihard=value
```

*userid* is a user name or numeric user ID. Each *kvalue* is a soft or hard limit for disk usage in kilobytes. Each *value* is a soft or hard limit for the number of files the user can own.

- To use the file (*quotafile*) created by command `repquota -e` (see the section “Administering Disk Quotas on XFS Filesystems” on page 175) as input to the `edquota` command, enter this command:

```
# /usr/etc/edquota -i quotafile
```

### Setting Disk Quota Limits for Groups on XFS Filesystems

After turning on disk quotas on a filesystem, you can set limits for groups on that filesystem. You set limits for groups just as you do for users, by using the `edquota` command as described in “Setting Disk Quota Limits for Users on XFS Filesystems” on page 171.

To use the `edquota` command to set limits for a project, you include the `-g` option on the command line. When you use the `-g` option with `edquota`, any name specified on the command line is considered a group name. For example, to specify limits for groups interactively, give this command:

```
# /usr/etc/edquota -g name ...
```

*name* is a group name or numeric group ID. For information on additional options of the `edquota` command, see the `edquota(1M)` man page.

Use of disk quota limits for groups and use of disk quota limits for projects are mutually exclusive.

### Setting Disk Quota Limits for Projects on XFS Filesystems

After turning on disk quotas on a filesystem, you can set limits for projects on that filesystem. You set limits for projects just as you do for users, by using the `edquota` command as described in “Setting Disk Quota Limits for Users on XFS Filesystems” on page 171.



To use the `edquota` command to set limits for a project, you include the `-j` option on the command line. When you use the `-j` option with `edquota`, any name specified on the command line is considered a project name. For example, to specify limits for projects interactively, give this command:

```
# /usr/etc/edquota -j name ...
```

*name* is a project name or numeric project ID. For information on additional options of the `edquota` command, see the `edquota(1M)` man page.

Use of disk quota limits for groups and use of disk quota limits for projects are mutually exclusive.

## Displaying Disk Quota Information on XFS Filesystems

Some commands that display information about disk quotas are as follows:

- To display a report that shows whether disk quotas are on or off for each filesystem, give this command as superuser:

```
# /usr/etc/repquota -sa
/dev/root (/):
-----
Status
      user  quota accounting      : on
      user  quota limit enforcement: on
      proj  quota accounting      : off
      proj  quota limit enforcement: off
      group quota accounting      : off
      group quota limit enforcement: off
Quota Storage
      user  quota inum 103156, blocks 8, extents 7
      proj  quota inum 103157, blocks 5, extents 4
Default Limits
      blocks time limit: 1.0 week
      files  time limit: 1.0 week
Cache
      dquot  currently cached in memory: 14
-----
```

The sections of the output are as follows:

**Status**            Lists the status of disk space accounting (on or off) and enforcement of disk quotas (on or off) for this filesystem.

**Quota Storage** Blocks and extents are the number of filesystem blocks and extents used to store disk quota information. The `inum` value is the inode number at which quota information is stored and is for internal use only.

**Default Limits** The blocks and files time limits are the default lengths of time for this filesystem that users have to reduce their disk space usage or number of files below their soft limits. These time limits can be set on a per-user basis by the command `edquota -t`.

**Cache** This section is for internal use only

- To get information about your disk quotas, enter this command:

```
# quota -v
Disk quotas for margo (uid 1606):
Filesystem  usage  quota  limit  timeleft  files  quota  limit  timeleft
/           138360    0      0      14971     0      0
/e         4156360  41200   0      1.6 days 222264   0      0
```

The columns in this output are:

|                         |   |
|-------------------------|---|
| <code>Filesystem</code> | Lists each of the filesystems that have quotas turned on.   |
| <code>usage</code>      | Lists the user's disk usage on each filesystem.   |
| <code>quota</code>      | The user's soft limit for disk usage or files on each filesystem.   |
| <code>limit</code>      | The user's hard limit for disk usage or files on each filesystem.   |
| <code>timeleft</code>   | For filesystems where the user's soft limit for disk usage or files is exceeded, gives the number of days until the user is prohibited from using additional disk space or creating more files. |
| <code>files</code>      | The number of files owned by the user on each filesystem.   |

- To get information about your group disk quotas, enter this command:

```
# quota -g -v
Disk quotas for staff (gid 50):
Filesystem  usage  quota  limit  timeleft  files  quota  limit  timeleft
/part1      4      0      0      2         0      0
```

- To get information about your project disk quotas, enter this command:

```
# quota -j -v
Disk quotas for xfsproj (projid 260):
Filesystem  usage  quota  limit  timeleft  files  quota  limit  timeleft
/sprite01   230    0      0      17         0      0
```

- To get information about the disk usage and quotas of all users, enter this command:

```
# /usr/etc/quot -a
```

### Administering Disk Quotas on XFS Filesystems

If the filesystem being dumped contains quotas, `xfsdump` will use `repquota(1M)` to store the quotas in the following three files in the root of the filesystem to be dumped:

```
xfsdump_quotas
    user quotas
xfsdump_quotas_proj
    project quotas
xfsdump_quotas_group
    group quotas
```

These files will then be included in the dump. These files will appear only for those quotas which are enabled on the filesystem being dumped. Upon restoration, `edquota(1M)` can be used to reactivate the quotas for the filesystem. Note, however, that the `xfsdump_quotas` file will probably require modification to change the filesystem or UIDs if the filesystem has been restored to a different partition or system.

To create a file that lists the current quota limits of all the filesystems for users, enter this command as superuser:

```
# /usr/etc/repquota -a -e quotafile
```

To create a file that lists the current quota limits of all the filesystems for groups, enter this command as superuser:

```
# /usr/etc/repquota -g -a -e quotafile
```

To create a file that lists the current quota limits of all the filesystems for projects, enter this command as superuser:

```
# /usr/etc/repquota -j -a -e quotafile
```

If you are familiar with using disk quotas on EFS filesystems, note that some quota commands that are used on EFS filesystems are not used on XFS filesystems. These commands are:

- `quotacheck`. There is no need to run `quotacheck` manually.
- `chkconfig quota on` and `chkconfig quota off`. Disk quotas are turned on during mounting, so mount options control whether disk quotas are on or off, not `chkconfig`.
- `chkconfig quotacheck on` and `chkconfig quotacheck off`. `quotacheck` is not used on XFS filesystems so these `chkconfig` commands have no effect.
- `/etc/init.d/quotas start`. This command has no effect on disk quota tracking on XFS systems.
- `touch quotas`. There is no need to create files called `quotas` in the root directory of each filesystem. Quota information is hidden in the XFS filesystem structure.
- `repquota` by non-superusers. Only the superuser can use the `repquota` command on XFS filesystems.

## Copying XFS Filesystems With `xfs_copy`

The `xfs_copy` command can be used to copy an XFS filesystem with an internal log (XFS filesystems with external logs or real-time subvolumes cannot be copied with `xfs_copy`). One or more copies can be created on disk partitions, logical volumes, or files. Each copy has a unique filesystem identifier, which enables them to be run as separate filesystems on the same system. (Programs that do block-by-block copying, such as `dd`, do not create unique filesystem identifiers.) Multiple copies are created in parallel. For more information, see the `xfs_copy(1M)` reference page.

An example of the `xfs_copy` command is:

```
# xfs_copy /dev/dsk/dks0d3s7 /dev/dsk/dks5d2s7
... 10% ... 20% ... 30% ... 40% ... 50% ... 60% ... 70% ... 80%
... 90% ... 100%
Done.
All copies completed.
```

## Checking XFS Filesystem Consistency With `xfs_check` and `xfs_repair`

XFS filesystem consistency checking can be done using the `xfs_check` command and the dry-run mode of the `xfs_repair` command. The `xfs_repair` command is sometimes able to repair filesystem inconsistencies.

## Checking Filesystem Consistency

The filesystem consistency checking commands for XFS filesystems are `xfs_check` and `xfs_repair -n`. (`fsck` is used only for EFS filesystems.) Unlike `fsck`, neither `xfs_check` nor `xfs_repair` are invoked automatically on system startup. They should be used only if you suspect a filesystem consistency problem.

Before running `xfs_check` or `xfs_repair -n`, the filesystem to be checked must be unmounted cleanly using normal system administration procedures (the `umount` command or system shutdown), not as a result of a crash or system reset. If the filesystem has not been unmounted cleanly, mount it and unmount it cleanly before running `xfs_check` or `xfs_repair -n`.

`xfs_repair -n` checks XFS filesystem consistency. `xfs_repair -n` performs a more complete check than `xfs_check`, but cannot be used to check filesystems with extended attributes or filesystems on XLV real-time subvolumes. The command line for `xfs_repair -n` is:

```
# xfs_repair -n device
```

*device* is the device file for a disk partition or logical volume that contains an XFS filesystem, for example `/dev/xlv/xlv0`.

The following example shows output with no consistency problems found:

```
Phase 1 - find and verify superblock...
Phase 2 - scan filesystem freespace and inode maps...
    - found root inode chunk
Phase 3 - for each AG...
    - scan (but don't clear) agi unlinked lists...
    - process known inodes and perform inode discovery...
    - process newly discovered inodes...
    - agno = 0
    - agno = 1
    ...
Phase 4 - check for duplicate blocks...
    - setting up duplicate extent list...
    - check for inodes claiming duplicate blocks...
    - agno = 0
    - agno = 1
    ...
No modify flag set, skipping phase 5
Phase 6 - check inode connectivity...
    - traversing filesystem starting at / ...
```

```
- traversal finished ...
- traversing all unattached subtrees ...
- traversals finished ...
- moving disconnected inodes to lost+found ...
Phase 7 - verify link counts...
No modify flag set, skipping filesystem flush and exiting.
```

`xfs_check` also checks XFS filesystem consistency. It can be used on filesystems with Extended Attributes (see the `attr(1)` reference page). (`xfs_repair` performs only limited checking of Extended Attributes.) The command line for `xfs_check` is:

```
# xfs_check device
```

If no consistency problems were found, `xfs_check` returns without displaying any messages.

## Repairing Inconsistent Filesystems

`xfs_repair` (without the `-n` option) checks XFS filesystem consistency and, if problems are detected, corrects them if possible. The filesystem to be checked and repaired must have been unmounted cleanly using normal system administration procedures (the `umount` command or system shutdown), not as a result of a crash or system reset. If the filesystem has not been unmounted cleanly, mount it and unmount it cleanly before running `xfs_repair`.

The command line for `xfs_repair` when you want it to repair any inconsistencies it finds is:

```
# xfs_repair device
```

*device* is the device file for a disk partition or logical volume that contains an XFS filesystem, for example `/dev/x1v/x1v0`. It must not be mounted.

An example of the output you see from running `xfs_repair` on a clean filesystem is:

```
Phase 1 - find and verify superblock...
Phase 2 - zero log...
        - scan filesystem freespace and inode maps...
        - found root inode chunk
Phase 3 - for each AG...
        - scan and clear agi unlinked lists...
        - process known inodes and perform inode discovery...
        - agno = 0
        - agno = 1
        ...
        - process newly discovered inodes...
Phase 4 - check for duplicate blocks...
        - setting up duplicate extent list...
        - clear lost+found (if it exists) ...
        - check for inodes claiming duplicate blocks...
        - agno = 0
        - agno = 1
        ...
Phase 5 - rebuild AG headers and trees...
        - reset superblock counters...
Phase 6 - check inode connectivity...
        - ensuring existence of lost+found directory
        - traversing filesystem starting at / ...
        - traversal finished ...
        - traversing all unattached subtrees ...
        - traversals finished ...
        - moving disconnected inodes to lost+found ...
Phase 7 - verify and correct link counts...
done
```

For information about using `xfs_repair` on an inconsistent filesystem, see “Repairing XFS Filesystem Problems” on page 180.

## Checking Foreign Filesystem Consistency With `fpck`

The IRIX operating system provides the `fpck` command to check and repair `hfs` (mac) and `dos` (`fat`) filesystems. When the `fpck` utility locates major filesystem structure destruction, such as critical sector damage or an unrecoverable error, it gives an error message. For less severe filesystem inconsistencies, it gives a warning message

---

**Note:** For repair of foreign filesystems, it can be more constructive to use the filesystem repair tools of the foreign operating system.

---

For information on using the `fpck` utility, see the `fpck(1M)` reference page. For further information on foreign filesystem types, see the `filesystems(4)` reference page. For information on creating foreign filesystems, see the `mkfp(1M)` reference page.

## Repairing XFS Filesystem Problems

The `xfs_repair` command checks XFS filesystem consistency and sometimes repairs problems that are found. This section describes the messages that you may see from `xfs_repair` and what to do if `xfs_repair` is not able to repair a filesystem.

### Common Error Messages

Some common error messages from `xfs_repair` and the repairs that it performs are the following:

```
disconnected inode 242002, moving to lost+found
    xfs_repair found an inode that is in use, but is not connected to the
    filesystem. The inode is moved to the filesystem's lost+found
    directory. Its name is its inode number, in this example 242002. If the
    disconnected inode is a directory, the directory's subtree is preserved—
    all its child inodes are automatically moved with it, so the entire
    directory subtree moves to lost+found.
```

```
imap claims in-use inode 2444941 is free, correcting imap
    The inode allocation map in the filesystem behaves as if inode 2444941
    is free, but the inode itself looks like it is still in use. xfs_repair
    corrects the inode map to say that the inode is in use.
```



entry references free inode 2444940 in shortform directory 2444922  
junking entry "fb" in directory inode 2444922  
A directory entry points to an inode that `xfs_repair` has determined is actually free. `xfs_repair` junks the directory entry. The term *shortform* means a small directory. In larger directories, the entry deletion is usually a two-pass process. In this case, the second part of the message reads something like `marking bad entry, marking entry to be deleted, or will clear entry`.

resetting inode 241996 nlinks from 5 to 3  
`xfs_repair` detected a mismatch between the number of directory entries pointing to the inode (links) and the number of links recorded in the inode. It corrected the number (from 5 to 3 in this case).

cleared inode 2444926  
There was something wrong with the inode that was not correctable, so `xfs_repair` turned it into a zero-length free inode. This usually happens because the inode claims blocks that are used by something else or the inode itself is badly corrupted. Typically, the `cleared inode` message is preceded by one or more messages indicating why the inode needs to be cleared.

## Error Messages When Files Are in lost+found

If `xfs_repair` has put files and directories in a filesystem's `lost+found` directory and you do not remove them, the next time you run `xfs_repair` it temporarily disconnects the inodes for those files and directories. They are reconnected before `xfs_repair` terminates. As a result of the disconnected inodes in `lost+found`, you see output like this:

```
Phase 1 - find and verify superblock...
Phase 2 - zero log...
        - scan filesystem freespace and inode maps...
        - found root inode chunk
Phase 3 - for each AG...
        - scan and clear agi unlinked lists...
        - process known inodes and perform inode discovery...
        - agno = 0
        - agno = 1
        ...
        - process newly discovered inodes...
Phase 4 - check for duplicate blocks...
        - setting up duplicate extent list...
        - clear lost+found (if it exists) ...
        - clearing existing "lost+found" inode
        - deleting existing "lost+found" entry
        - check for inodes claiming duplicate blocks...
        - agno = 0
imap claims in-use inode 242000 is free, correcting imap
        - agno = 1
        - agno = 2
        ...
Phase 5 - rebuild AG headers and trees...
        - reset superblock counters...
Phase 6 - check inode connectivity...
        - ensuring existence of lost+found directory
        - traversing filesystem starting at / ...
        - traversal finished ...
        - traversing all unattached subtrees ...
        - traversals finished ...
        - moving disconnected inodes to lost+found ...
disconnected inode 242000, moving to lost+found
Phase 7 - verify and correct link counts...
done
```

In this example, inode 242000 was an inode that was moved to `lost+found` during a previous `xfs_repair` run. This run of `xfs_repair` found that the filesystem is consistent. If the `lost+found` directory had been empty, in phase 4 only the messages about clearing and deleting the `lost+found` directory would have appeared. The left-justified `imap claims` and `disconnected inode` messages appear (one pair of messages per inode) if there are inodes in the `lost+found` directory.

## What to Do If `xfs_repair` Cannot Repair a Filesystem

If `xfs_repair` fails to repair the filesystem successfully, try giving the same `xfs_repair` command twice more; `xfs_repair` may be able to make more repairs on successive runs. If `xfs_repair` fails to fix the consistency problems in three tries, your next step depends upon where it failed:

- If `xfs_repair` failed in phase 1, you must restore lost files from backups.
- If `xfs_repair` failed in phase 2 or later, you may be able to restore files from the disk by backing up and restoring the files on the filesystem.

If `xfs_repair` failed in phase 2 or later, follow these steps:

1. Mount the filesystem using `mount -r` (read-only).
2. Make a filesystem backup with `xfsdump`.
3. Use `mkfs` to make a new filesystem on the same disk partition or XLV logical volume.
4. Restore the files from the backup with `xfsrestore`.

See *IRIX Admin: Backup, Security, and Accounting* for information about `xfsdump` and `xfsrestore`.

## Mounting A Filesystem Without Log Recovery

If a filesystem is damaged to the extent that you are unable to mount the filesystem successfully in the standard fashion, you may be able to recover some of its data by mounting the filesystem with the `-o norecover` option of the `mount` command. This option mounts the filesystem without running log recovery. You must mount the filesystem as read-only when you use this option.

When you mount the filesystem in norecovery mode when it was not unmounted cleanly, the filesystem is likely to be inconsistent, and you will be unable to read all of its data. However, you may be able to recover data that you cannot otherwise access.

For information on the mount command and its options, see the `mount(1M)` and the `fstab(4)` reference pages.

## Running `xfs_repair` on the Root Filesystem

If you find that your root filesystem is corrupted, you can run `xfs_repair` on the root filesystem itself. In order to do this, you run the `xfs_repair` command from the miniroot using the following procedure:

1. Boot the miniroot. The procedure for performing a miniroot installation is provided in *IRIX Admin: Software Installation and Licensing*.
2. From the miniroot **Main Menu**, select the **Administrative Commands** menu.
3. Get a single-user shell by selecting `sh`.
4. Run `xfs_repair` on the root filesystem, which in most cases will be `/dev/dsk/dks0d1s0`.

## System Administration for Guaranteed-Rate I/O

Guaranteed-rate I/O, or GRIO for short, is a mechanism that enables a user application to reserve part of a system's I/O resources for its exclusive use. For example, it can be used to enable "real-time" retrieval and storage of data streams. GRIO manages the system resources among competing applications, so the actions of new processes do not affect the performance of existing ones. GRIO can read and write only files on a real-time subvolume of an XFS filesystem. To use GRIO, the subsystem `coe.sw.xfsrt` must be installed.

This chapter explains important guaranteed-rate I/O concepts, describes how to configure a system for GRIO; and provides instructions for creating an XLV logical volume for use with applications that use GRIO.

The major sections in this chapter are:

- "Guaranteed-Rate I/O Overview" on page 186
- "GRIO Guarantee Types" on page 189
- "GRIO System Components" on page 192
- "Hardware Configuration Requirements for GRIO" on page 193
- "Configuring a System for GRIO" on page 193
- "Additional Procedures for GRIO" on page 197
- "Using Real-Time Subvolumes" on page 201
- "GRIO File Formats" on page 202

For additional information, see the `grio(5)` reference page.

---

**Note:** By default, IRIX supports four GRIO streams (concurrent uses of GRIO). To increase the number of streams to 40, you can purchase the High Performance Guaranteed-Rate I/O—5-40 Streams software option. For even more streams, you can purchase the High Performance Guaranteed-Rate I/O—Unlimited Streams software option.

---

## Guaranteed-Rate I/O Overview

The guaranteed-rate I/O system (GRIO) allows applications to reserve specific I/O bandwidth to and from the filesystem. Applications request guarantees by providing a file descriptor, data rate, duration, and start time. The filesystem calculates the performance available and, if the request is granted, guarantees that the requested level of performance can be met for a given time. This frees programmers from having to predict system I/O performance and is critical for media delivery systems such as video-on-demand.

The GRIO mechanism is designed for use in an environment where many different processes attempt to access scarce I/O resources simultaneously. GRIO provides a way for applications to determine that resources are already fully utilized and attempts to make further use would have a negative performance impact.

If the system is running a single application that needs access to all the system resources, the GRIO mechanism does not need to be used. Because there is no competition, the application gains nothing by reserving the resources before accessing them.

Applications negotiate with the system to make a GRIO *reservation*, an agreement by the system to provide a portion of the bandwidth of a system resource for a period of time. The system resources supported by GRIO are files residing within real-time subvolumes of XFS filesystems. A reservation can be transferred to any process and to any file on the filesystem specified in the request.

A GRIO reservation associates a data rate with a filesystem. A data rate is defined as the number of bytes per a fixed period of time (called the *time quantum*). The application receives data from or transmits data to the filesystem starting at a specific time and continuing for a specific period. For example, a reservation could be for 1.2 MB every 1.29 seconds, for the next three hours, to or from the filesystem on `/dev/xlv/video1`. In this example, 1.29 seconds is the time quantum of the reservation.

The application issues a reservation request to the system, which either accepts or rejects the request. If the reservation is accepted, the application then associates the reservation with a particular file. It can begin accessing the file at the reserved time, and it can expect that it will receive the reserved number of bytes per time quantum throughout the time of the reservation. If the system rejects the reservation, it returns the maximum amount of bandwidth that can be reserved for the resource at the specified time. The application can determine whether the available bandwidth is sufficient for its needs and issue another reservation request for the lower bandwidth, or it can schedule the reservation for a different time.

The GRIO reservation continues until it expires or an explicit `grio_unreserve_bw()` library call is made (for more information, see the `grio_unreserve_bw(3)` reference pages). A GRIO reservation is also removed on the last close of a file currently associated with a reservation.

If a process has a rate guarantee on a file, any reference by that process to that file uses the rate guarantee, even if a different file descriptor is used. However, any other process that accesses the same file does so without a guarantee or must obtain its own guarantee. This is true even when the second process has inherited the file descriptor from the process that obtained the guarantee.

Sharing file descriptors between processes in an ancestral process group is supported for files used for GRIO, and the processes share the guarantee. For example, if a process got a rate guarantee of 2 Mb/s on a file and then forked, and the parent and child access the same file, they would be able to receive a combined rate of 2 Mb/s. If the child wanted a 4 Mb/s guarantee on the file, it would have to close and reopen the file and get a new rate guarantee of 4 Mb/s on it.

Four sizes are important to GRIO:

Optimal I/O size

Optimal I/O size is the size of the I/O operations that the system actually issues to the disks. All the disks in the real-time subvolume of an XLV volume must have the same optimal I/O size. Optional I/O sizes of disks in real-time subvolumes of different XLV volumes can differ. For more information see “/etc/grio\_disks File Format” on page 202.

XLV volume stripe unit size

The XLV volume stripe unit size is the amount of data written to a single disk in the stripe. The XLV volume stripe unit size must be an even multiple of the optimal I/O size for the disks in that subvolume. See “Introduction to XLV Logical Volumes” in Chapter 3 for more information.

Reservation size (also known as the rate)

The reservation size is the amount of I/O that an application issues in a single time quantum.

Application I/O size

The application I/O size is the size of the individual I/O requests that an application issues. An application I/O size that equals the reservation size is recommended, but not required. The reservation size must be an even multiple of the application I/O size, and the application I/O size must be an even multiple of the optimal I/O size.

The application is responsible for making sure that all I/O requests are issued within a given time quantum, so that the system can provide the guaranteed data rate.



## GRIO Guarantee Types

In addition to specifying the amount and duration of the reservation, the application must specify the type of guarantee desired. There are four different classes of options that need to be determined when obtaining a rate guarantee:

- The rate guarantee can be made on a per-file or per-filesystem basis.
- The rate guarantee can be private or shared.
- The rate guarantee can be a fixed rotor, slip rotor, or non-rotor type.
- The rate guarantee can have deadline or real-time scheduling, or it can be nonscheduled.

If the user does not specify any options, the rate guarantee has these options by default: shared, non-rotor options, and deadline scheduling. The per-file or per-filesystem guarantee is determined by the `libgrio` calls to make the reservation: either the `grio_reserve_file()` or `grio_reserve_file_system()` library calls.

### Per-File and Per-Filesystem Guarantees

A *per-file* guarantee indicates that the given rate guarantee can be used only on one specific file. When a *per-filesystem* guarantee is obtained, the guarantee can be transferred to any file on the given filesystem.

### Private and Shared Guarantees

A *private* guarantee can be used only by the process that obtained the guarantee; it cannot be transferred to another process. A *shared* guarantee can be transferred from one process to another. Shared guarantees are only transferable; they cannot be used by both processes at the same time.

### Rotor and Non-Rotor Guarantees

The *rotor* type of guarantee (either fixed or slip) is also known as a VOD (video on demand) guarantee. It allows more streams to be supported per disk drive, but requires that the application provide careful control of when and where I/O requests are issued.

Rotor guarantees are supported only when using a striped real-time subvolume. When an application accesses a file, the accesses are time-multiplexed among the drives in the stripe. An application can only access a single disk during any one time quantum, and consecutive accesses are assumed to be sequential. Therefore, the stripe unit must be set to the number of kilobytes of data that the application needs to access per time quantum. (The stripe unit is set with the `xlv_make` command when volume elements are created.) If the application tries to access data on a different disk when it has a slip rotor guarantee, the system attempts to change the process's rotor slot so that it can access the desired disk. If the application has a fixed rotor guarantee it is suspended until the appropriate time quantum for accessing the given disk.

An application with a fixed rotor reservation that does not access a file sequentially, but rather skips around in the file, has a performance impact. For example, if the real-time subvolume is created on a four-way stripe, it could take as long as four (the size of the volume stripe) times the time quantum for the first I/O request after a seek to complete.

*Non-rotor* guarantees do not have such restrictions. Applications with non-rotor guarantees normally access the file in entire stripe size units, but can access smaller or larger units without penalty as long as they are within the bounds of the rate guarantee. The accesses to the file do not have to be sequential, but must be on stripe boundaries. If an application tries to access the file more quickly than the guarantee allows, the actions of the system are determined by the type of scheduling guarantee.

## An Example Comparing Rotor and Non-Rotor Guarantees

Assume the system has eight disks, each supporting twenty-three 64 KB operations per second. (You can use the command `grio_bandwidth` to learn the number of I/O operations of a given size that can be performed on a particular disk in one second.) For non-rotor GRIO, if an application needs 512 KB of data each second, the eight disks are arranged in a eight-way stripe. The stripe unit is 64 KB. Each application read/write operation is 512 KB and causes concurrent read/write operations on each disk in the stripe. The application can access any part of the file at any time, provided that the read/write operation always starts at a stripe boundary. This configuration provides 23 process streams with 512 KB of data each second.

With a rotor guarantee, the eight drives are given an optimal I/O size of 512 KB. Each drive can support seven such operations each second. The higher rate (7 x 512 KB versus 23 x 64 KB) is achievable because the larger transfer size does less seeking. Again the drives are arranged in an eight-way stripe but with a stripe unit of 512 KB. Each drive can support seven 512K streams per second for a total of  $8 * 7 = 56$  streams. Each of the

56 streams is given a time period (also known as a time “bucket”). There are eight different time periods with seven different processes in each period. Therefore,  $8 * 7 = 56$  processes are accessing data in a given time unit. At any given second, the processes in a single time period are allowed to access only a single disk.

Using a rotor guarantee more than doubles the number of streams that can be supported with the same number of disks. The tradeoff is that the time tolerances are very stringent. Each stream is required to issue the read/write operations within one time quantum. If the process issues the call too late and real-time scheduling is used, the request blocks until the next time period for that process on the disk. In this example, this could mean a delay of up to eight seconds. In order to receive the rate guarantee, the application must access the file sequentially. The time periods move sequentially down the stripe allowing each process to access the next 512 KB of the file.

## Real-Time Scheduling, Deadline Scheduling, and Nonscheduled Reservations

Three types of reservation scheduling are possible: *real-time* scheduling, *deadline* scheduling, and *non-scheduled* reservations.

Real-time scheduling means that an application receives a fixed amount of data in a fixed length of time. The data can be returned at any time during the time quantum. This type of reservation is used by applications that do only a small amount of buffering. If the application requests more data than its rate guarantee, the system suspends the application until it falls within the guaranteed bandwidth.

Deadline scheduling means that an application receives a minimum amount of data in a fixed length of time. Such guarantees are used by applications that have a large amount of buffer space. The application requests I/O at a rate at least as fast as the rate guarantee and is suspended only when it is exceeding its rate guarantee and there is no additional device bandwidth available.

Nonscheduled reservations means that the guarantee received by the application is only a reservation of system bandwidth. The system does not enforce the reservation limits and therefore cannot guarantee the I/O rate of any of the guarantees on the system. Nonscheduled reservations should be used with extreme care.

## GRIO System Components

Several components make up the GRIO mechanism: a system daemon, support commands, configuration files, and an application library.

The system daemon is `ggd`. It is started from the script `/etc/rc2.d/S94grio` when the system is started. It is always started; unlike some other daemons, it is not turned on and off with the `chkconfig` command. A lock file is created in the `/tmp` directory to prevent two copies of the daemon from running simultaneously. Requests for rate guarantees are made to the `ggd` daemon. The daemon reads the GRIO configuration file `/etc/grio_disks`.

`/etc/grio_disks` describes the performance characteristics for the types of disk drives that are supported on the system, including how many I/O operations of each size (64 KB, 128 KB, 256 KB, or 512 KB) can be executed by each piece of hardware in one second. You can edit the file to add support for new drive types. (You can use the command `grio_bandwidth` to learn the number of I/O operations of a given size that can be performed on a particular disk in one second.) The format of this file is described in “`/etc/grio_disks` File Format” on page 202.

The command `grio_bandwidth` can be used to learn the number of I/O operations of a given size that can be performed on a particular disk in one second.

The `/usr/lib/libgrio.so` libraries contain a collection of routines that enable an application to establish a GRIO session. The library routines are the only way in which an application program can communicate with the `ggd` daemon. The library also includes a library routine that applications can use to check the amount of bandwidth available on a filesystem. This enables them to quickly get an idea of whether or not a particular reservation might be granted—more quickly than actually making the request.

## Hardware Configuration Requirements for GRIO

Guaranteed-rate I/O requires the hardware to be configured so that it follows these guidelines:

- Put only real-time subvolume volume elements on a single disk (not log or data subvolume volume elements). This configuration is recommended for soft guarantees and required for hard guarantees.
- Each XLV volume you create with a real-time subvolume must include a data subvolume, even if you do not intend to use it. The data subvolume is used by XFS to store inodes and other internal filesystem information.
- Disks used in the data and log subvolumes of the XLV logical volume must have their retry mechanisms enabled. The data and log subvolumes contain information critical to the filesystem and cannot afford an occasional disk error.

## Configuring a System for GRIO

---

**Caution:** The procedure in this section can result in the loss of data if it is not performed properly. It is recommended only for experienced IRIX system administrators.

---

This section describes how to configure a system for GRIO: create an XLV logical volume with a real-time subvolume, make a filesystem on the volume and mount it, and configure and restart the `gpd` daemon.

1. Choose disk partitions for the XLV logical volume and confirm the hardware configuration as described in “Hardware Configuration Requirements for GRIO” on page 193. This includes modifying the disk drive parameters as described in “Disabling Disk Error Recovery” on page 197. Be sure to create a data disk partition and subvolume for each real-time subvolume you create.

2. Determine the values of variables used while constructing the XLV logical volume:

|                 |  |
|-----------------|--|
| <i>vol_name</i> | The name of the volume with a real-time subvolume.   |
| <i>rate</i>     | The rate at which applications using this volume access the data. <i>rate</i> is the number of bytes per time quantum per stream (the rate) divided by 1 KB. This information may be available in published information about the applications or from the developers of the applications. |

|                    |   |
|--------------------|---|
| <i>num_disks</i>   | The number of disks included in the real-time subvolume of the volume.  |
| <i>stripe_unit</i> | <p>When the real-time disks are striped (required for video on demand and recommended otherwise), this is the amount of data written to one disk before writing to the next. It is expressed in 512-byte sectors.</p> <p>For non-rotor guarantees:<br/><math>stripe\_unit = rate * 1K / (num\_disks * 512)</math></p> <p>For rotor guarantees:<br/><math>stripe\_unit = rate * 1K / 512</math></p>  |
| <i>extent_size</i> | <p>The filesystem extent size.</p> <p>For non-rotor guarantees:<br/><math>extent\_size = rate * 1K</math></p> <p>For rotor guarantees:<br/><math>extent\_size = rate * 1K * num\_disks</math></p>   |
| <i>opt_IO_size</i> | <p>The optimal I/O size. It is expressed in kilobytes. By default, the possible values for <i>opt_IO_size</i> are 64 (64 KB), 128 (128 KB), 256 (256 KB), and 512 (512 KB). Other values can be added by editing the <code>/etc/grio_disks</code> file (see “<code>/etc/grio_disks</code> File Format” on page 202 for more information).</p> <p>For non-rotor guarantees, <i>opt_IO_size</i> must be an even factor of <i>stripe_unit</i>, but not less than 64.</p> <p>For rotor guarantees <i>opt_IO_size</i> must be an even factor of <i>rate</i>. Setting <i>opt_IO_size</i> equal to <i>rate</i> is recommended.</p> |

Table 8-1 gives examples for the values of these variables.

**Table 8-1** Examples of Values of Variables Used in Constructing an XLV Logical Volume Used for GRIO

| Variable           | Type of Guarantee | Comment   | Example Value |
|--------------------|-------------------|---|---------------|
| <i>vol_name</i>    | any               | This name matches the last component of the device name for the volume, /dev/xlv/vol_name | xlv_grio      |
| <i>rate</i>        | any               | For this example, assume 512 KB per second per stream                                     | 512           |
| <i>num_disks</i>   | any               | For this example, assume 4 disks  | 4             |
| <i>stripe_unit</i> | non-rotor         | 512*1K/(4*512)  | 256           |
|                    | rotor             | 512*1K/512  | 1024          |
| <i>extent_size</i> | non-rotor         | 512 * 1K  | 512 KB        |
|                    | rotor             | 512 * 1K * 4  | 2048 KB       |
| <i>opt_IO_size</i> | non-rotor         | 128/1 = 128 or 128/2 = 64 are possible  | 64            |
|                    | rotor             | Same as <i>rate</i>   | 512           |

3. Create an `xlv_make` script file that creates the XLV logical volume. (See “Creating Volume Objects With `xlv_make`” in Chapter 4 for more information.) Example 8-1 shows an example script file for a volume.

**Example 8-1** Configuration File for a Volume Used for GRIO

```
# Configuration file for logical volume vol_name. In this
# example, data and log subvolumes are partitions 0 and 1 of
# the disk at unit 1 of controller 1. The real-time
# subvolume is partition 0 of the disks at units 1-4 of
# controller 2.
#
vol vol_name
data
plex
ve dks1d1s0
log
plex
ve dks1d1s1
rt
plex
ve -stripe -stripe_unit stripe_unit dks2d1s0 dks2d2s0 dks2d3s0 dks2d4s0
show
end
exit
```

4. Run `xlv_make` to create the volume:

```
# xlv_make script_file
```

*script\_file* is the `xlv_make` script file you created in step 3.

5. Create the filesystem by entering this command:

```
# mkfs -r extsize=extent_size /dev/xlv/vol_name
```

6. To mount the filesystem immediately, enter these commands:

```
# mkdir mountdir
```

```
# mount /dev/xlv/vol_name mountdir
```

*mountdir* is the full pathname of the directory that is the mount point for the filesystem.

7. To configure the system so that the new filesystem is automatically mounted when the system is booted, add this line to `/etc/fstab`:

```
/dev/xlv/vol_name mountdir xfs rw,raw=/dev/rxlv/vol_name 0 0
```



8. Restart the ggd daemon:

```
# /etc/init.d/grio stop
# /etc/init.d/grio start
```

Now the user application can be started. Files created on the real-time subvolume volume can be accessed using guaranteed-rate I/O.

## Additional Procedures for GRIO

The following subsections describe additional special-purpose procedures for configuring disks and GRIO system components. It is not advisable to perform these tuning procedures, because they can cause bad data to be returned from disk drives. However, in situations where data access speed is more important than data integrity, these tunings may be helpful.

### Disabling Disk Error Recovery

---

**Caution:** Setting disk drive parameters must be performed correctly on approved disk drive types only. Performing the procedure incorrectly, or performing it on an unapproved type of disk drive can severely damage the disk drive. Setting disk drive parameters should be performed only by experienced system administrators.

---

The procedure for setting disk drive parameters is shown below. In this example all of the parameters shown in Table 8-2 are changed for a disk on controller 131 at drive address 1.

**Table 8-2** Disk Drive Parameters for GRIO

| Parameter  | New Setting |
|--|-------------|
| Auto bad block reallocation (read)   | Disabled    |
| Auto bad block reallocation (write)  | Disabled    |
| Delay for error recovery (disabling this parameter enables the read continuous (RC) bit) | Disabled    |

1. Start `fx` in expert mode:

```
# fx -x
fx version 6.4, Sep 29, 1996
```

2. Specify the disk whose parameters you want to change by answering the prompts:

```
fx: "device-name" = (dksc) Enter
fx: ctrlr# = (0) 131
fx: drive# = (1) 1
fx: lun# = (0)
...opening dksc(131,1,0)
```

```
...drive selftest...OK
```

3. Confirm that the disk drive is disk drive type SGI 0664N1D 6s61 or disk drive type SGI 0664N1D 4I4I. These disk drive types are approved for changing disk parameters. The disk drive type appears in the next line of output:

```
Scsi drive type == SGI      0664N1D      6s61
----- please choose one (? for help, .. to quit this menu)-----
[exi]t          [d]ebug/          [l]abel/
[b]adbblock/    [ex]ercise/      [r]epartition/
```

4. Show the current settings of the disk drive parameters (this command uses the shortcut of separating commands on a series of hierarchical menus with slashes):

```
fx > label/show/parameters
```

```
----- current drive parameters-----
Error correction enabled          Enable data transfer on error
Don't report recovered errors     Do delay for error recovery
Don't transfer bad blocks         Error retry attempts          10
Do auto bad block reallocation (read)
Do auto bad block reallocation (write)
Drive readahead enabled           Drive buffered writes disabled
Drive disable prefetch 65535      Drive minimum prefetch          0
Drive maximum prefetch 65535     Drive prefetch ceiling         65535
Number of cache segments          4
Read buffer ratio 0/256           Write buffer ratio              0/256
Command Tag Queueing disabled
```

```
----- please choose one (? for help, .. to quit this menu)-----
[exi]t          [d]ebug/          [l]abel/
[b]adbblock/    [ex]ercise/      [r]epartition/
```

The parameters in Table 8-2 correspond to Do auto bad block reallocation (read), Do auto bad block reallocation (write), and Do delay for error recovery, in that order. Each of them is currently enabled.

5. Give the command to start setting disk drive parameters and press **Enter** until you reach a parameter that you want to change:

```
fx> label/set/parameters
fx/label/set/parameters: Error correction = (enabled) Enter
fx/label/set/parameters: Data transfer on error = (enabled) Enter
fx/label/set/parameters: Report recovered errors = (disabled) Enter
```

6. To change the delay for error recovery parameter to disabled, enter “disable” the prompt:

```
fx/label/set/parameters: Delay for error recovery = (enabled) disable
```

7. Press **Enter** through other parameters that do not need changing:

```
fx/label/set/parameters: Err retry count = (10) Enter
fx/label/set/parameters: Transfer of bad data blocks = (disabled) Enter
```

8. To change the auto bad block reallocation parameters, enter **disable** at their prompts:

```
fx/label/set/parameters: Auto bad block reallocation (write) = (enabled) disable
fx/label/set/parameters: Auto bad block reallocation (read) = (enabled) disable
```

9. Press **Enter** through the rest of the parameters:

```
fx/label/set/parameters: Read ahead caching = (enabled) Enter
fx/label/set/parameters: Write buffering = (disabled) Enter
fx/label/set/parameters: Drive disable prefetch = (65535) Enter
fx/label/set/parameters: Drive minimum prefetch = (0) Enter
fx/label/set/parameters: Drive maximum prefetch = (65535) Enter
fx/label/set/parameters: Drive prefetch ceiling = (65535) Enter
fx/label/set/parameters: Number of cache segments = (4) Enter
fx/label/set/parameters: Enable CTQ = (disabled) Enter
fx/label/set/parameters: Read buffer ratio = (0/256) Enter
fx/label/set/parameters: Write buffer ratio = (0/256) Enter
```

10. Confirm that you want to make the changes to the disk drive parameters by entering “yes” to this question and start exiting fx:

```
* * * * * W A R N I N G * * * * *
about to modify drive parameters on disk dksc(131,1,0)! ok? yes

----- please choose one (? for help, .. to quit this menu)-----
[exi]t                [d]ebug/                [l]abel/                [a]uto
[b]adblock/          [ex]ercise/            [r]epartition/        [f]ormat
fx> exit
```

11. Confirm again that you want to make the changes to the disk drive parameters by pressing **Enter** in response to this question:

```
label info has changed for disk dksc(131,1,0). write out changes? (yes) Enter
```

## Restarting the ggd Daemon

After either the `/etc/grio_disks` or `/etc/config/ggd.options` files are modified, `ggd` must be restarted to make the changes take effect. Give these commands to restart `ggd`:

```
# /etc/init.d/grio stop
# /etc/init.d/grio start
```

When `ggd` is restarted, current rate guarantees are lost.

## Running ggd as a Real-time Process

Running `ggd` as a real-time process dedicates one or more CPUs to performing GRIO requests exclusively. Follow this procedure on a multiprocessor system to run `ggd` as a real-time process:

1. Create or modify the file `/etc/config/ggd.options` and add `-c cpunum` to the file. `cpunum` is the number of a processor to be dedicated to GRIO. This causes the CPU to be marked isolated, restricted to running selected processes, and nonpreemptive. Processes using GRIO should mark their processes as real-time and runnable only on CPU `cpunum`. The `sysmp(2)` reference page explains how to do this.
2. Restart the `ggd` daemon. See “Restarting the ggd Daemon” on page 200 for directions.

3. After `gpd` is restarted, you can confirm that the CPU is marked by entering this command (`cpunum` is 3 in this example):

```
# mpadmin -s
processors: 0 1 2 3 4 5 6 7
unrestricted: 0 1 2 5 6 7
isolated: 3
restricted: 3
preemptive: 0 1 2 4 5 6 7
clock: 0
fast clock: 0
```

4. To mark an additional CPU for real-time processes after `gpd` is restarted, enter these commands:

```
# mpadmin -rcpunum2
# mpadmin -Icpunum2
# mpadmin -ccpunum2
```

## Using Real-Time Subvolumes

The files you create on the real-time subvolume of an XLV logical volume are known as real-time files. The next two sections describe the special characteristics of these files.

### Files on the Real-Time Subvolume and Commands

Real-time files have some special characteristics that cause standard IRIX commands to operate in ways that you might not expect. In particular:

- You cannot create real-time files using any standard commands. Only specially written programs can create real-time files. The section “File Creation on the Real-Time Subvolume” on page 202 explains how.
- Real-time files are displayed by `ls`, just as any other file. However, there is no way to tell from the `ls` output whether a particular file is on a data subvolume or is a real-time file on a real-time subvolume. Only a specially written program can determine the type of a file. The `F_FSGETXATTR fcntl()` system call can determine whether a file is a real-time or a standard data file. If the file is a real-time file, the `fsx_xflags` field of the `fsxattr` structure has the `XFS_XFLAG_REALTIME` bit set.

- The `df` command displays the disk space in the data subvolume by default. When the `-r` option is given, the real-time subvolume's disk space and usage is added. `df` can report that there is free disk space in the filesystem when the real-time subvolume is full, and `df -r` can report that there is free disk space when the data subvolume is full.

## File Creation on the Real-Time Subvolume

To create a real-time file, use the `F_FSSETXATTR fcntl()` system call with the `XFS_XFLAG_REALTIME` bit set in the `fsx_xflags` field of the `fsxattr` structure. This must be done after the file has first been created/opened for writing, but before any data has been written to the file. Once data has been written to a file, the file cannot be changed from a standard data file to a real-time file, nor can files created as real-time files be changed to standard data files.

Real-time files can only be read or written using direct I/O. Therefore, `read()` and `write()` system call operations to a real-time file must meet the requirements specified by the `F_DIOINFO fcntl()` system call. See the `open(2)` reference page for a discussion of the `O_DIRECT` option to the `open()` system call.

## GRIO File Formats

The following subsections contain reference information about the contents of the two GRIO configuration files `/etc/grio_disks` and `/etc/config/ggd.options`.

### `/etc/grio_disks` File Format

The file `/etc/grio_disks` contains information that describes I/O bandwidth parameters of the various types of disk drives that can be used on the system.

By default, `/etc/grio_disks` contains the parameters for disks supported by Silicon Graphics for optimal I/O sizes of 64 KB, 128 KB, 256 KB, and 512 KB. Table 8-3 lists some of these disks. Table 8-4 shows the optimal I/O sizes and the number of optimal I/O size requests each of the disks listed in Table 8-3 can handle in one second.

**Table 8-3** Disks in /etc/grio\_disks by Default

| Disk ID String |          |              |        |
|----------------|----------|--------------|--------|
| "SGI           | IBM      | DFHSS2E      | 1111 " |
| "SGI           | SEAGATE  | ST31200N8640 | "      |
| "SGI           | SEAGATE  | ST31200N9278 | "      |
| "SGI           | 066N1D   |              | 4I4I " |
| "SGI           | 0064N1D  |              | 4I4I " |
| "SGI           | 0664N1D  |              | 4I4I " |
| "SGI           | 0664N1D  |              | 6S61 " |
| "SGI           | 0664N1D  |              | 6s61 " |
| "SGI           | 0664N1H  |              | 6s61 " |
| "IBM OEM       | 0663E15  |              | eSfS " |
| "IMPRIMIS      | 94601-15 |              | 1250 " |
| "SEAGATE       | ST4767   |              | 2590 " |

**Table 8-4** Optimal I/O Sizes and the Number of Requests per Second Supported

| Optimal I/O Size | Number of Requests per Second |
|------------------|-------------------------------|
| 65536            | 23                            |
| 131072           | 16                            |
| 262144           | 9                             |
| 524288           | 5                             |

To add other disks or to specify a different optimal I/O size, you must add information to the `/etc/grio_disks` file. If you modify `/etc/grio_disks`, you must restart the `ggd` daemon for the changes to take effect (see "Restarting the `ggd` Daemon" on page 200).

The records in `/etc/grio_disks` are in these two forms:

```
ADD "disk id string" optimal_iosize number_optio_per_second
```

```
REPLACE devicename optal_iosize number_optio_per_second
```

If the first field is the keyword `ADD`, the next field is a 28-character string that is the drive manufacturer's disk ID string. The next field is an integer denoting the optimal I/O size of the device in bytes. The last field is an integer denoting the number of optimal I/O size requests that the disk can satisfy in one second.

Some examples of these records are:

```
ADD      "SGI      SEAGATE ST31200N9278"  64K      23
```

```
ADD      "SGI              0064N1D 4I4I"  50K      25
```

If the first field is the keyword `REPLACE`, the next field is the pathname of a device (for a description of pathnames, see the `grio(1M)` man page). The third field is an integer denoting the optimal I/O size to be used on the device, and the number of I/O operations of that size that it can deliver per second.

An example of a `REPLACE` record is:

```
REPLACE /dev/rdisk/dks136d1s0 50K 20
```

## **`/etc/config/ggd.options` File Format**

`/etc/config/ggd.options` contains command-line options for the `ggd` daemon. Options you might include in this file are:

`-c cpunum` Dedicate CPU `cpunum` to performing GRIO requests exclusively.

`-o iosize` Specify default optimal I/O size for all devices (e.g., 64, 128, 256, 512).

If you change this file, you must restart `ggd` to make your changes take effect. See "Restarting the `ggd` Daemon" on page 200 for more information.



## EFS Filesystems

---

**Note:** Support for EFS filesystems will be discontinued in a future IRIX release. For information on converting EFS filesystems to XFS filesystems, see Chapter 6, “Creating and Growing Filesystems.”

---

The EFS filesystem is the original IRIX filesystem. This appendix describes the EFS filesystem and provides information on how to perform various administration tasks on EFS filesystems.

The major sections in this appendix are:

- “EFS Filesystem Overview” on page 205
- “EFS Filesystem Creation” on page 207
- “EFS Filesystem Creation Procedure” on page 207
- “Growing an EFS Filesystem Onto Another Disk” on page 209
- “EFS Filesystem Checking” on page 210
- “EFS Filesystem Reorganization” on page 212
- “Repairing EFS Filesystem Problems” on page 215

### EFS Filesystem Overview

The EFS filesystem is the original IRIX filesystem. It contains an enhancement to the standard UNIX filesystem called *extents* (defined below), and thus is called the Extent File System (EFS). The maximum size of an EFS filesystem is about 8 GB. It uses a filesystem block size of 512 bytes and allows a maximum file size of 2 GB minus 1 byte.

Advanced features of EFS are that it keeps multiple inode tables in close proximity to data blocks rather than a single inode table, and it uses a bitmap to keep track of free blocks instead of a list of free blocks.

Inodes are created when an EFS filesystem is created, not when files are created. When a file is created, an inode is allocated to that file. Thus, the maximum number of files in a filesystem is limited by the number of inodes in that filesystem. By default, the number of inodes created is a function of the size of the partition or logical volume. Typically one inode is created for every 4 KB in the partition or logical volume. You can specify the number of inodes with the `-n` option to the filesystem creation command, `mkfs`. Inodes use disk space, so there is a tradeoff between the number of inodes and the amount of disk space available for files.

The first block of an EFS filesystem is not used. Information about the filesystem is stored in the second block of the filesystem (block 1), called the *superblock*. This information includes:

- The size of the filesystem, in both physical and logical blocks
- The read-only flag; if set, the filesystem is read only
- The superblock-modified flag; if set, the superblock has been modified
- The date and time of the last update
- The total number of index nodes (*inodes*) allocated
- The total number of inodes free
- The total number of free blocks
- The starting block number of the free block bitmap

The superblock bitmap is followed by the inodes and data blocks. Each contiguous group of data blocks that make up a file is called an extent. There are 12 extent addresses in an inode. Extents are of variable length, anywhere from 1 to 148 contiguous blocks.

An inode contains addresses for 12 extents, which can hold a combined 1536 blocks, or 786,432 bytes. If a file is large enough that it cannot fit in the 12 extents, each extent is then loaded with the address of up to 148 *indirect* extents. The indirect extents then contain the actual data that makes up the file. Because EFS uses indirect extents, you can create files up to 2 GB, assuming you have that much disk space available in your filesystem.

The last block of the filesystem is a duplicate of the filesystem superblock. This is a safety precaution that provides a backup of the critical information stored in the superblock.

## EFS Filesystem Creation

To turn a disk partition or logical volume into an EFS filesystem, the `mkfs` command must be used. It takes a disk partition or logical volume and divides it up into areas for data blocks, inodes, and free lists, and writes out the appropriate inode tables, superblocks, and block maps. It creates the filesystem's root directory and a `lost+found` directory.

An example `mkfs` command for making an EFS filesystem is:

```
# mkfs -t efs /dev/rdisk/dks0d2s7
```

After using `mkfs` to create an EFS filesystem, run the `fsck` command to verify that the disk is consistent. For information on the `fsck` command, see "Repairing EFS Filesystem Problems" on page 215.

For more instructions on making EFS filesystems see "EFS Filesystem Creation Procedure" on page 207, and the `mkfs(1M)` and `mkfs_efs(1M)` reference pages.

## EFS Filesystem Creation Procedure

The procedure in this section explains how to make an EFS filesystem on a disk partition or on a logical volume and mount it. (See Chapter 4, "Creating and Administering XLV Logical Volumes," for information on creating logical volumes.) This procedure assumes that the disk or logical volume is empty. If it contains valuable data, the data must be backed up because it is destroyed during this procedure.

---

**Tip:** You can make an EFS filesystem on a disk partition using the Disk Manager in the System Toolchest. For information on the Disk Manager, see the "Disk Manager" section in Chapter 3 of the *Personal System Administration Guide*.

---

---

**Caution:** When you create a filesystem, all files already on the disk partition or logical volume are destroyed.

---

1. Identify the device name of the partition or logical volume where you plan to create the filesystem. This is the value of *partition* in the examples below. For example, if you plan to use partition 7 (the entire disk) of a SCSI option disk on controller 0 and drive address 2, *partition* is `/dev/dsk/dks0d2s7`. For more information on determining *partition*, see “Introduction to XLV Logical Volumes” in Chapter 3, and the `dks(7M)` reference page.

2. If the disk partition is already mounted, unmount it:

```
# umount partition
```

Any data that is on the disk partition is destroyed. To convert the data rather than destroy it, use the procedure in “Converting a Filesystem on an Option Disk From EFS to XFS” in Chapter 6 instead.

3. Create a new filesystem with the `mkfs` command, for example,

```
# mkfs -t efs /dev/rdisk/dks0d2s7
```

The argument to `mkfs` is the block or character device for the disk partition or logical volume. You can use either the block device or the character device.

In the above example, `mkfs` uses default values for the filesystem parameters. If you want to use parameters other than the default, you can specify these on the `mkfs` command line. See the `mkfs_efs(1M)` reference page for information about using command line parameters and proto files.

4. To use the filesystem, you must mount it. For example,

```
# mkdir /rsrch  
# mount /dev/dsk/dks0d2s7 /rsrch
```

For more information about mounting filesystems, see “Manually Mounting Filesystems” in Chapter 7.

5. To configure the system so that this filesystem is automatically mounted when the system is booted up, add an entry in the file `/etc/fstab` for the new filesystem. For example,

```
/dev/dsk/dks0d2s7 /rsrch efs rw,raw=/dev/rdisk/dks0d2s7 0 0
```

For more information about automatically mounting filesystems, see “Mounting Filesystems Automatically With the `/etc/fstab` File” in Chapter 7.

## Growing an EFS Filesystem Onto Another Disk

The procedure in this section explains how to grow an EFS filesystem onto another disk.

The following steps show how to grow a filesystem mounted at `/disk2` onto an XLV logical volume created out of the `/disk2` disk partition and a new disk. The procedure assumes that the new disk is installed on the system and partitioned.

---

**Caution:** All files on the additional disk are destroyed by this procedure.

---

1. Make a backup of the filesystem you are going to extend.
2. Unmount the `/disk2` filesystem:

```
# umount /disk2
```

3. Use `xlvmake` to create an XLV logical volume out of the `/disk2` partition and the new disk. The `/disk2` partition must be the first volume element in the data subvolume. For example:

```
# xlvmake
xlvmake> vol xlv0
xlvmake> data
xlvmake> plex
xlvmake> ve dks0d2s7
xlvmake> ve dks0d3s7
xlvmake> end
Object specification completed
xlvmake> exit
Newly created objects will be written to disk.
Is this what you want?(yes) yes
Invoking xlv_assemble
```

4. Grow the EFS filesystem into the logical volume with the `growfs` command:

```
# growfs /dev/xlv/xlv0
```

5. Run `fsck` on the expanded filesystem:

```
# fsck /dev/xlv/xlv0
```

6. Mount the logical volume:

```
# mount /dev/xlv/xlv0 /disk2
```

7. Change the entry for /disk2 in the file /etc/fstab to mount the logical volume rather than the disk partition:

```
/dev/xlv/xlv0 /disk2 efs rw,raw=/dev/rxlv/xlv0 0 0
```

## EFS Filesystem Checking

The `fsck` command checks EFS filesystem consistency and data integrity. Filesystems are usually checked automatically when the system is booted. Except for the root filesystem, filesystems must be unmounted while being checked. You might want to invoke `fsck` manually at these times:

- Before making a backup
- After doing a restore
- After doing disk maintenance
- Before installing software
- Before manually mounting a dirty filesystem
- When `fsck` runs automatically and has many errors

For a detailed explanation of the checks performed by `fsck` and the options it presents when it finds problems, see “Repairing EFS Filesystem Problems” on page 215.

Before checking an EFS filesystem other than the root filesystem for consistency, the filesystem should be unmounted. (The root filesystem can be checked while mounted.) Unmounting can be achieved by explicitly unmounting the filesystem, or by shutting the system down and bringing it up in single-user mode. (See “Unmounting Filesystems” in Chapter 7 for information on unmounting filesystems and the `single(1M)` reference page for information on shutting the system down and bringing it up in single-user mode.) Checking unmounted filesystems is described in “Checking Unmounted Filesystems” on page 211.

If you cannot shut down the system and cannot unmount the filesystem, but you need to perform the check immediately, you can run `fsck` in “no-write” mode. The `fsck` command checks the filesystem, but makes no changes and does not repair inconsistencies. The procedure is explained in “Checking Mounted Filesystems” on page 212.

You may find it convenient to check multiple filesystems at once. This is also known as *parallel* checking. The `fsck -m` flag is used for parallel checking. For more information about this and other `fsck` options, see the `fsck(1M)` reference page.

## Checking Unmounted Filesystems

To check a single, unmounted filesystem, enter this command as *root*:

```
# fsck filesystem
```

*filesystem* is the device file name of the filesystem’s disk partition or logical volume, for example `/dev/usr`, `/dev/dsk/dks0d2s7`, or `/dev/dsk/lv2`; see “Introduction to XLV Logical Volumes” in Chapter 3 and “Filesystem Names” in Chapter 5 for more information.

As `fsck` runs, it proceeds through a series of steps, or *phases*. You may see an error-free check:

```
fsck: Checking /dev/usr
** Phase 1 - Check Blocks and Sizes
** Phase 2 - Check Pathnames
** Phase 3 - Check Connectivity
** Phase 4 - Check Reference Counts
** Phase 5 - Check Free List
7280 files 491832 blocks 38930 free
```

If there are no errors, you are finished checking the filesystem.

If errors are detected in the filesystem, `fsck` displays an error message. “Repairing EFS Filesystem Problems” on page 215 explains how to proceed.

## Checking Mounted Filesystems

If you cannot shut down the system and cannot unmount the filesystem, but you need to perform the check immediately, you can run `fsck` in “no-write” mode. The `fsck` command checks the filesystem, but makes no changes and does not repair inconsistencies.

For example, the following command invokes `fsck` in no-write mode:

```
# fsck -n /dev/usr
```

If inconsistencies are found, they are not repaired. You must run `fsck` again without the `-n` flag to repair any problems. The benefit of this procedure is that you should be able to gauge the severity of the problems with your filesystem. The disadvantage of this procedure is that `fsck` may show inconsistencies that do not really exist (because the filesystem is active).

## EFS Filesystem Reorganization

EFS filesystems can become fragmented over time. When a filesystem is fragmented, blocks of free space are small and files have many extents. The `fsr` command, when run on an EFS filesystem, reorganizes filesystems so that the layout of the extents is improved and free disk space is coalesced. This improves overall performance.

By default, `fsr` is run automatically once a week from `crontab`. If the `fsr` command determines that a mounted filesystem is an EFS filesystem, the command calls the `fsr_efs` command. See the `fsr(1M)` reference page for information on the `fsr` command, and the `fsr_efs(1M)` man page for information on the `fsr_efs` options for the command.



## EFS Filesystem Disk Space Management

Consider the following characteristics of EFS filesystems when managing your disk space:

- If you find yourself short on disk space, consider that the `lost+found` directory at the root of EFS filesystems may be full. If you log in as `root`, you can check this directory and determine if the files there can be removed.
- On EFS filesystems, when a filesystem is more than about 90- to 95-percent full, system performance may degrade, depending on the size of the disk. (The number of free disk blocks on a 97-percent full large disk is larger than the number of free disk blocks on a 97-percent full small disk.) Monitor the amount of available space and take steps to keep an adequate amount available.

## Using Disk Quotas on EFS Filesystems

The use of disk quotas to limit users' use of disk space is discussed in the section "Disk Quotas" in Chapter 5. The following subsections explain how to impose and monitor disk quotas on EFS filesystems. For additional information, see the `quota(1)`, `edquota(1M)`, `quot(1M)`, `quotacheck(1M)`, `quotaon(1M)`, `repquota(1M)`, and `quotas(4)` reference pages.

## Imposing Disk Quotas on EFS Filesystems

To impose soft disk quotas on EFS filesystems, follow these steps:

1. To enable the quotas subsystem, enter these commands:

```
# chkconfig quotas on
# chkconfig quotacheck on
```
2. Create a file named `quotas` in the root directory of each filesystem that is to have a disk quota. This file should be zero length and should be writable only by `root`. To create the `quotas` file, give this command as `root` in the root directory of each of these filesystems:

```
# touch quotas
```

3. Establish the quota amounts for individual users. The `edquota` command can be used to set the limits for each user. For example, to set soft limits of 100 MB and 100 inodes on the user ID `sedgwick`, give the following command:

```
# /usr/etc/edquota sedgwick
```

The screen clears, and you are placed in the editor specified by the `EDITOR` environment variable (`vi` if `$EDITOR` is not set) to edit the user's disk quota. You see:

```
fs / kbytes(soft=0, hard=0) inodes(soft=0, hard=0)
```

The filesystem appears first, in this case the root filesystem (`/`). The numeric values for disk space are in kilobytes, not megabytes, so to specify 100 megabytes, you must multiply the number by 1024. The number of inodes should be entered directly.

4. Edit the line to appear as follows:

```
fs / kbytes(soft=102400, hard=0) inodes(soft=100, hard=0)
```
5. Save the file and quit the editor after you enter the correct values. If you leave the value at 0, no limit is imposed. Because you are setting only soft limits in this example, the hard values have not been set.
6. Use the `-p` option of `edquota` to assign the same quota to multiple users. Unless explicitly given a quota, users have no limits set on the amount of disk they can use or the number of files they can create.
7. Issue the `quotaon` command to put the quotas into effect. For quotas to be accurate, this command should be issued on a local filesystem immediately after the filesystem has been mounted. The `quotaon` command enables quotas for a particular filesystem, or with the `-a` option, enables quotas for all filesystems indicated in `/etc/fstab` as using quotas. See the `fstab(4)` reference page for complete details on the `/etc/fstab` file.

Quotas will be automatically enabled at boot time in the future. The script `/etc/init.d/quotas` handles enabling of quotas and uses the `chkconfig` command to check the `quotas` configuration flag to decide whether or not to enable quotas. If you need to turn quotas off, use the `quotaoff` command.

## Monitoring Disk Quotas on EFS Filesystems

Periodically, check the records retained in the quota file for consistency with the actual number of blocks and files allocated to the user using the `quotacheck` command. It is not necessary to unmount the filesystem or disable the quota system to run this command, though on active filesystems, slightly inaccurate results may be seen.

`quotacheck` is run automatically at boot time by the `/etc/init.d/quotas` script if the `quotacheck` flag has been turned on with `chkconfig`. `quotacheck` can take a considerable amount of time to execute, so it is convenient to have it done at boot time.

## Repairing EFS Filesystem Problems

The `fsck` command checks EFS filesystem consistency and sometimes repairs problems that are found. This section describes the messages that are produced by each phase of `fsck`, what they mean, and what you should do about each one.

### General Errors

The following abbreviations are used in `fsck` error messages:

|       |                             |
|-------|-----------------------------|
| BLK   | Block number                |
| DUP   | Duplicate block number      |
| DIR   | Directory name              |
| MTIME | Time file was last modified |
| UNREF | Unreferenced                |

The following sections use these single-letter abbreviations:

|          |                           |
|----------|---------------------------|
| <i>B</i> | Block number              |
| <i>F</i> | File (or directory) name  |
| <i>I</i> | Inode number              |
| <i>M</i> | File mode                 |
| <i>O</i> | User ID of a file's owner |

|   |   |
|---|---|
| S | File size   |
| T | Time file was last modified   |
| X | Link count, or number of BAD, DUP, or MISSING blocks, or number of files (depending on context) |
| Y | Corrected link count number, or number of blocks in filesystem (depending on context)           |
| Z | Number of free blocks   |

In actual `fsck` output, these abbreviations are replaced by the appropriate numbers.

Two error messages may appear in any phase. Although `fsck` prompts for you to continue checking the filesystem, it is generally best to regard these errors as fatal. Stop the command and investigate what may have caused the problem.

CAN NOT READ: BLK *B* (CONTINUE?)

The request to read a specified block number *B* in the filesystem failed. This error indicates a serious problem, probably a hardware failure or an error that causes `fsck` to try to read a block that is not in the filesystem. Press **n** to stop `fsck`. Shut down the system to the System Maintenance Menu and run hardware diagnostics on the disk drive and controller.

CAN NOT WRITE: BLK *B* (CONTINUE?)

The request for writing a specified block number *B* in the filesystem failed. The disk may be write-protected or there may be a hardware problem. Press **n** to stop `fsck`. Check to make sure the disk is not set to "read only." (Some, though not all, disks have this feature.) If the disk is not write-protected, shut down the system to the System Maintenance Menu and run hardware diagnostics on the disk drive and controller.

## Initialization Phase

The command line syntax is checked. Before the filesystem check can be performed, `fsck` sets up some tables and opens some files. The `fsck` command terminates if there are initialization errors.

## Phase 1 Check Blocks and Sizes

This phase checks the inode list. It reports error conditions resulting from:

- Checking inode types
- Setting up the zero-link-count table
- Examining inode block numbers for bad or duplicate blocks
- Checking inode size
- Checking inode format

## Phase 1 Error Messages

Phase 1 has three types of error messages: information messages, messages with a `CONTINUE?` prompt, and messages with a `CLEAR?` prompt. The responses that you give to Phase 1 prompts affect `fsck` functions. The possible responses are discussed in “Phase 1 Responses” on page 219. Typically, the right answer is Yes, except as noted.

`UNKNOWN FILE TYPE I=I (CLEAR?)`

The mode word of the inode *I* suggests that the inode is not a pipe, special character inode, regular inode, directory inode, symbolic link, or socket.

`LINK COUNT TABLE OVERFLOW (CONTINUE?)`

There is no more room in an internal table for `fsck` containing allocated inodes with a link count of zero.

`B BAD I=I`

Inode *I* contains block number *B* with a number lower than the number of the first data block in the filesystem or greater than the number of the last block in the filesystem. This error condition may invoke the `EXCESSIVE BAD BLKS` error condition in Phase 1 if inode *I* has too many block numbers outside the filesystem range. This error condition invokes the `BAD/DUP` error condition in Phase 2 and Phase 4.

`EXCESSIVE BAD BLOCKS I=I (CONTINUE?)`

There is more than a tolerable number (usually 50) of blocks with a number lower than the number of the first data block in the filesystem or greater than the number of the last block in the filesystem associated with inode *I*.

- B* DUP *I*=*I* Inode *I* contains block number *B*, which is already claimed by another inode. This error condition may invoke the EXCESSIVE DUP BLKS error condition in Phase 1 if inode *I* has too many block numbers claimed by other inodes. This error condition invokes Phase 1B and the BAD/DUP error condition in Phase 2 and Phase 4. Typically, you should answer No the first time this error appears and Yes the second time if you know the files claimed by the other inode.
- EXCESSIVE DUP BLKS *I*=*I* (CONTINUE?)  
There is more than a tolerable number (usually 50) of blocks claimed by other inodes.
- DUP TABLE OVERFLOW (CONTINUE?)  
There is no more room in an internal table in *fsck* containing duplicate block numbers.
- PARTIALLY ALLOCATED INODE *I*=*I* (CLEAR?)  
Inode *I* is neither allocated nor unallocated.
- RIDICULOUS NUMBER OF EXTENTS (*n*) (max allowed *n*)  
The number of extents is larger than the maximum the system can set and is therefore ridiculous.
- ILLEGAL NUMBER OF INDIRECT EXTENTS (*n*)  
The number of extents or pointers to extents (indirect extents) exceeds the number of slots in the inode for describing extents.
- BAD MAGIC IN EXTENT  
The pointer to an extent contains a “magic number.” If this number is invalid, the pointer to the extent is probably corrupt.
- EXTENT OUT OF ORDER  
An extent’s idea of where it is in the file is inconsistent with the extent pointer in relation to other extent pointers.
- ZERO LENGTH EXTENT  
An extent is zero length.
- ZERO SIZE DIRECTORY  
It is erroneous for a directory inode to claim a size of zero. The corresponding inode is cleared.
- DIRECTORY SIZE ERROR  
A directory’s size must be an integer number of blocks. The size is recomputed based on its extents.

**DIRECTORY EXTENTS CORRUPTED**

If the computation of size (above) fails, `fsck` prints this message and asks to clear the inode.

**NUMBER OF EXTENTS TOO LARGE**

The number of extents or pointers to extents (indirect extents) exceeds the number of slots in the inode for describing extents.

**POSSIBLE DIRECTORY SIZE ERROR**

The number of blocks in the directory computed from extent pointer lengths is inconsistent with the number computed from the inode size field.

**POSSIBLE FILE SIZE ERROR**

The number of blocks in the file computed from extent pointer lengths is inconsistent with the number computed from the inode size field. `fsck` gives the option of clearing the inode in this case.

## Phase 1 Responses

Table A-1 explains the significance of responses to Phase 1 prompts:

**Table A-1** Meaning of `fsck` Phase 1 Responses

| Prompt    | Response | Meaning   |
|-----------|----------|---|
| CONTINUE? | n        | Terminate the command.  |
| CONTINUE? | y        | Continue with the command. This error condition means that a complete check of the filesystem is not possible. A second run of <code>fsck</code> should be made to recheck this filesystem. |
| CLEAR?    | n        | Ignore the error condition. A No response is appropriate only if the user intends to take other measures to fix the problem.  |
| CLEAR?    | y        | Deallocate inode <i>I</i> by zeroing its contents. This may invoke the UNALLOCATED error condition in Phase 2 for each directory entry pointing to this inode.                              |

## Phase 1B Rescan for More Bad Dups

When a duplicate block is found in the filesystem, the filesystem is rescanned to find the inode that previously claimed that block. When the duplicate block is found, the following information message is printed:

*B DUP I=I* Inode *I* contains block number *B*, which is already claimed by another inode. This error condition invokes the `BAD/DUP` error condition in Phase 2. Inodes with overlapping blocks can be determined by examining this error condition and the `DUP` error condition in Phase 1.

## Phase 2 Check Pathnames

This phase traverses the pathname tree, starting at the root directory. `fsck` examines each inode that is being used by a file in a directory of the filesystem being checked.

Referenced files are marked in order to detect unreferenced files later on. The command also accumulates a count of all links, which it checks against the link counts found in Phase 4.

Phase 2 reports error conditions resulting from the following:

- Root inode mode and status incorrect
- Directory inode pointers out of range
- Directory entries pointing to bad inodes

`fsck` examines the root directory inode first, because this directory is where the search for all pathnames must start.

If the root directory inode is corrupted, or if its type is not `directory`, `fsck` prints error messages. Generally, if a severe problem exists with the root directory it is impossible to salvage the filesystem. `fsck` allows attempts to continue under some circumstances.

## Phase 2 Error Messages

The following error messages result from problems with the root directory inode. The possible responses are discussed in “Phase 2 Responses” on page 222.



ROOT INODE UNALLOCATED. TERMINATING

The root inode points to incorrect information. There is no way to fix this problem, so the command stops.

If this problem occurs on the root filesystem, you must reinstall IRIX. If it occurs on another filesystem, you must recreate the filesystem using `mkfs` and recover files and data from backups.

ROOT INODE NOT A DIRECTORY. FIX?

The root directory inode does not seem to describe a directory. This error is usually fatal. The typical answer is Yes.

DUPS/BAD IN ROOT INODE. CONTINUE?

Something is wrong with the block addressing information of the root directory. The typical answer is Yes.

Other Phase 2 messages have a `REMOVE?` prompt. These messages are:

`I OUT OF RANGE I=I NAME=F (REMOVE?)`

A directory entry *F* has an inode number *I* that is greater than the end of the inode list. The typical answer is Yes.

`UNALLOCATED I=I OWNER=O MODE=M SIZE=S MTIME=T NAME=F (REMOVE?)`

A directory entry *F* has an inode *I* that is not marked as allocated. The owner *O*, mode *M*, size *S*, modify time *T*, and filename *F* are printed. If the filesystem is not mounted and the `-n` option is not specified, and if the inode that the entry points to is size 0, the entry is removed automatically.

`DUP/BAD I=I OWNER=O MODE=M SIZE=S MTIME=T DIR=F (REMOVE?)`

Phase 1 or Phase 1B found duplicate blocks or bad blocks associated with directory entry *F*, directory inode *I*. The owner *O*, mode *M*, size *S*, modify time *T*, and directory name *F* are printed. Typically, you should answer No the first time this error appears and Yes the second time if you know the files claimed by the other inode.

`DUP/BAD I=I OWNER=O MODE=M SIZE=S MTIME=T FILE=F (REMOVE?)`

Phase 1 or Phase 1B found duplicate blocks or bad blocks associated with file entry *F*, inode *I*. The owner *O*, mode *M*, size *S*, modify time *T*, and filename *F* are printed. Typically, you should answer No the first time this error appears and Yes the second time if you know the files claimed by the other inode.

## Phase 2 Responses

Table A-2 describes the significance of responses to Phase 2 prompts:

**Table A-2** Meaning of Phase 2 fsck Responses

| Prompt    | Response | Meaning  |
|-----------|----------|--|
| FIX?      | n        | fsck terminates.   |
| FIX?      | y        | fsck treats the contents of the inode as a directory, even though the inode mode indicates otherwise. If the directory is actually intact, and only the inode mode is incorrectly set, this may recover the directory. |
| CONTINUE? | n        | fsck terminates.   |
| CONTINUE? | y        | fsck attempts to continue with the check. If some of the root directory is still readable, pieces of the files system may be salvaged.   |
| REMOVE?   | n        | Ignore the error condition. A No response is appropriate only if the user intends to take other action to fix the problem.   |
| REMOVE?   | y        | Remove a bad directory entry.  |

## Phase 3 Check Connectivity

Phase 3 of fsck locates any unreferenced directories detected in Phase 2 and attempts to reconnect them. It reports error conditions resulting from:

- Unreferenced directories
- Missing or full `lost+found` directories

## Phase 3 Error Messages

Phase 3 has two types of error messages: information messages and messages with a `RECONNECT?` prompt. The possible responses are discussed in “Phase 3 Responses” on page 223.

UNREF DIR I=*I* OWNER=*O* MODE=*M* SIZE=*S* MTIME=*T* (RECONNECT?)

The directory inode *I* was not connected to a directory entry when the filesystem was traversed. The owner *O*, mode *M*, size *S*, and modify time *T* of directory inode *I* are printed. The `fsck` command forces the reconnection of a nonempty directory. The typical answer is yes.

SORRY. NO `lost+found` DIRECTORY

No `lost+found` directory is in the root directory of the filesystem; `fsck` ignores the request to link a directory in `lost+found`. The unreferenced file is removed.

Use `fsck -l` to recover and remake the `lost+found` directory as soon as possible.

SORRY. NO SPACE IN `lost+found` DIRECTORY

There is no space to add another entry to the `lost+found` directory in the root directory of the filesystem; `fsck` ignores the request to link a directory in `lost+found`. The unreferenced file is removed.

Use `fsck -l` to recover and clean out the `lost+found` directory as soon as possible.

DIR I=*I1* CONNECTED. PARENT WAS I=*I2*

This is an advisory message indicating that a directory inode *I1* was successfully connected to the `lost+found` directory. The parent inode *I2* of the directory inode *I1* is replaced by the inode number of the `lost+found` directory.

### Phase 3 Responses

Table A-3 explains the significance of responses to Phase 3 prompts:

**Table A-3** Meaning of `fsck` Phase 3 Responses

| Prompt     | Response | Meaning  |
|------------|----------|--|
| RECONNECT? | n        | Ignore the error condition. This invokes the UNREF error condition in Phase 4. A No response is appropriate only if the user intends to take other action to fix the problem.  |
| RECONNECT? | y        | Reconnect directory inode <i>I</i> to the filesystem in the directory for lost files ( <code>lost+found</code> ). This may invoke a <code>lost+found</code> error condition if there are problems connecting directory inode <i>I</i> to <code>lost+found</code> . If the link was successful, this invokes a CONNECTED information message. |

## Phase 4 Check Reference Counts

This phase checks the link count information seen in Phases 2 and 3 and locates any unreferenced regular files. It reports error conditions resulting from:

- Unreferenced files
- A missing or full `lost+found` directory
- Incorrect link counts for files, directories, or special files
- Unreferenced files and directories
- Bad and duplicate blocks in files and directories
- Incorrect counts of total free inodes

## Phase 4 Error Messages

Phase 4 has five types of error messages:

- Information messages
- Messages with a `RECONNECT?` prompt
- Messages with a `CLEAR?` prompt
- Messages with an `ADJUST?` prompt
- Messages with a `FIX?` prompt

The possible responses are discussed in “Phase 4 Responses” on page 226. The typical answer is `Yes`, except as noted.

```
UNREF FILE I=I OWNER=O MODE=M SIZE=S MTIME=T (RECONNECT?)
```

Inode *I* was not connected to a directory entry when the filesystem was traversed. The owner *O*, mode *M*, size *S*, and modify time *T* of inode *I* are printed. If the `-n` option is omitted and the filesystem is not mounted, empty files are cleared automatically. Nonempty files are not cleared.

```
SORRY. NO lost+found DIRECTORY
```

There is no `lost+found` directory in the root directory of the filesystem; `fsck` ignores the request to link a file in `lost+found`.

Use `fsck -l` to recover and create the `lost+found` directory as soon as possible.

SORRY. NO SPACE IN `lost+found` DIRECTORY

There is no space to add another entry to the `lost+found` directory in the root directory of the filesystem; `fsck` ignores the request to link a file in `lost+found`.

Use `fsck -l` to recover and clean out the `lost+found` directory as soon as possible.

(CLEAR) The inode mentioned in the immediately previous UNREF error condition cannot be reconnected, so it is cleared.

LINK COUNT FILE `I=I OWNER=O MODE=M SIZE=S MTIME=T COUNT=X SHOULD BE Y (ADJUST?)`

The link count for inode `I`, which is a file, is `X` but should be `Y`. The owner `O`, mode `M`, size `S`, and modify time `T` are printed.

LINK COUNT DIR `I=I OWNER=O MODE=M SIZE=S MTIME=T COUNT=X SHOULD BE Y (ADJUST?)`

The link count for inode `I`, which is a directory, is `X` but should be `Y`. The owner `O`, mode `M`, size `S`, and modify time `T` of directory inode `I` are printed.

LINK COUNT `F I=I OWNER=O MODE=M SIZE=S MTIME=T COUNT=X SHOULD BE Y (ADJUST?)`

The link count for `F` inode `I` is `X` but should be `Y`. The filename `F`, owner `O`, mode `M`, size `S`, and modify time `T` are printed.

UNREF FILE `I=I OWNER=O MODE=M SIZE=S MTIME=T (CLEAR?)`

Inode `I`, which is a file, was not connected to a directory entry when the filesystem was traversed. The owner `O`, mode `M`, size `S`, and modify time `T` of inode `I` are printed. If the `-n` option is omitted and the filesystem is not mounted, empty files are cleared automatically. Nonempty directories are not cleared. Typically, you should answer no the first time this error appears and yes the second time if you know the files claimed by the other inode.

UNREF DIR `I=I OWNER=O MODE=M SIZE=S MTIME=T (CLEAR?)`

Inode `I`, which is a directory, was not connected to a directory entry when the filesystem was traversed. The owner `O`, mode `M`, size `S`, and modify time `T` of inode `I` are printed. If the `-n` option is omitted and the filesystem is not mounted, empty directories are cleared automatically. Nonempty directories are not cleared. Typically, you should answer no the first time this error appears and yes the second time if you know the files claimed by the other inode.

BAD/DUP FILE `I=I OWNER=O MODE=M SIZE=S MTIME=T (CLEAR?)`

Phase 1 or Phase 1B found duplicate blocks or bad blocks associated with file inode `I`. The owner `O`, mode `M`, size `S`, and modify time `T` of

inode *I* are printed. Typically, you should answer no the first time this error appears and yes the second time if you know the files claimed by the other inode.

BAD/DUP DIR I=*I* OWNER=*O* MODE=*M* SIZE=*S* MTIME=*T* (CLEAR?)

Phase 1 or Phase 1B found duplicate blocks or bad blocks associated with directory inode *I*. The owner *O*, mode *M*, size *S*, and modify time *T* of inode *I* are printed. Typically, you should answer no the first time this error appears and yes the second time if you know the files claimed by the other inode.

FREE INODE COUNT WRONG IN SUPERBLK (FIX?)

The actual count of the free inodes does not match the count in the superblock of the filesystem.

## Phase 4 Responses

Table A-4 describes the significance of responses to Phase 4 prompts:

**Table A-4** Meaning of fsck Phase 4 Responses

| Prompt     | Response | Meaning   |
|------------|----------|---|
| RECONNECT? | n        | Ignore this error condition. This invokes a CLEAR error condition later in Phase 4.   |
| RECONNECT? | y        | Reconnect inode <i>I</i> to filesystem in the directory for lost files (lost+found). This can cause a lost+found error condition in this phase if there are problems connecting inode <i>I</i> to lost+found. |
| CLEAR?     | n        | Ignore the error condition. A No response is appropriate only if the user intends to take other action to fix the problem.  |
| CLEAR?     | y        | Deallocate the inode by zeroing its contents.   |
| ADJUST?    | n        | Ignore the error condition. A No response is appropriate only if the user intends to take other action to fix the problem.  |
| ADJUST?    | y        | Replace link count of file inode <i>I</i> with the link counted computed in Phase 2.  |
| FIX?       | n        | Ignore the error condition. A No response is appropriate only if the user intends to take other action to fix the problem.  |
| FIX?       | y        | Fix the problem.  |

## Phase 5 Check Free List

Phase 5 checks the free-block list. It reports error conditions resulting from:

- Bad blocks in the free-block list
- Bad free-block count
- Duplicate blocks in the free-block list
- Unused blocks from the filesystem not in the free-block list
- Total free-block count incorrect

## Phase 5 Error Messages

Phase 5 has four types of error messages:

- Information messages
- Messages that have a `CONTINUE?` prompt
- Messages that have a `FIX?` prompt
- Messages that have a `SALVAGE?` prompt

The possible responses are discussed in “Phase 5 Responses” on page 228. The typical answer is `Yes`.

`FREE BLK COUNT WRONG IN SUPERBLOCK (FIX?)`

The actual count of free blocks does not match the count in the superblock of the filesystem.

`BAD FREE LIST (SALVAGE?)`

This message is always preceded by one or more of the Phase 5 information messages.

## Phase 5 Responses

Table A-5 describes the significance of responses to Phase 5 prompts:

**Table A-5** Meanings of Phase 5 fsck Responses

| Prompt    | Response | Meaning  |
|-----------|----------|--|
| CONTINUE? | n        | Terminate the command.   |
| CONTINUE? | y        | Ignore the rest of the free-block list and continue execution of <i>fsck</i> . This error condition always invokes a BAD BLKS IN FREE LIST error condition later in Phase 5. |
| FIX?      | n        | Ignore the error condition. A No response is appropriate only if the user intends to take other action to fix the problem.   |
| FIX?      | y        | Replace count in superblock by actual count.   |
| SALVAGE?  | n        | Ignore the error condition. A No response is appropriate only if the user intends to take other action to fix the problem.   |
| SALVAGE?  | y        | Replace actual free-block bitmap with a new free-block bitmap.   |

## Phase 6 Salvage Free List

This phase reconstructs the free-block bitmap. There are no error messages that can be generated in this phase and no responses are required.

## Cleanup Phase

Once a filesystem has been checked, a few cleanup functions are performed. The cleanup phase displays advisory messages about the filesystem and status of the filesystem.

### Cleanup Phase Messages

`X files Y blocks Z free`

This is an advisory message indicating that the filesystem checked contained X files using Y blocks leaving Z blocks free in the filesystem.



**SUPERBLOCK MARKED DIRTY**

A field in the superblock is queried by system commands to decide if `fsck` must be run before mounting a filesystem. If this field is not “clean,” `fsck` reports and asks if it should be cleaned.

**PRIMARY SUPERBLOCK WAS INVALID**

If the primary superblock is too corrupt to use, and `fsck` can locate a secondary superblock, it asks to replace the primary superblock with the backup.

**SECONDARY SUPERBLOCK MISSING**

If there is no secondary superblock, and `fsck` finds space for one, it asks to create a secondary superblock.

**CHECKSUM WRONG IN SUPERBLOCK**

An incorrect checksum makes a filesystem unmountable.

**\*\*\*\*\* FILE SYSTEM WAS MODIFIED \*\*\*\*\***

This is an advisory message indicating that the current filesystem was modified by `fsck`.

**\*\*\*\*\* REMOUNTING ROOT... \*\*\*\*\***

This is an advisory message indicating that `fsck` made changes to a mounted root filesystem. The automatic remount ensures that in-core data structures and the filesystem are consistent.



---

# Index

/ filesystem. See root filesystem.

## A

allocation groups, 130

attributes, 111

## B

backup and restore

  commands, 112

  during conversion to XFS, 142, 148, 151

bad block handling, 4

block device files

  as a type of file, 108

  description, 14-18

block sizes

  and `mkfs`, 133, 149

  guidelines, 126

  range of sizes, 111, 126

  syntax, 126

## C

CacheFS filesystems, 114

cdda filesystem, 118

`cfsadmin` command, 114

character device files

  as a type of file, 108

  description, 14-18

`chkconfig` command

`no cleantmp` option, 161

`quota check` option, 213, 215

`quotas` option, 213, 214

cloning system disks, 46-48

compatibility

  32-bit programs and XFS, 111

`dump/restore` and filesystem type, 112

  NFS, 111

concatenation

  definition, 61

  guidelines, 69

  not allowed on root filesystems, 66

controllers

  identifying controller number, 20

  number of disk drives, 2

  supported, 2

conventions, typographical, xxiv

CPUs

  and versions of `fx`, 29

  and versions of `sash`, 13, 29

  restrict to running GRIIO processes, 200, 204

CXFS filesystems, xxiii, 101, 112

## D

daemons

  GRIIO, 192, 200

  XLV, 65

- deadline scheduling, 191
- /debug filesystem, 114
- device files
  - creating mnemonic names, 36
  - description, 14-18
  - ls listings, 15
  - major and minor device numbers, 16
  - names, 16-18
  - permissions and owner, 16
  - See also block device files, character device files.
  - using as command arguments, 21
  - XLV device file names, 51, 65
- device names
  - disk for dump file, 141
  - identifying with devnm, 141
  - mnemonic, 36
  - tape drive, 141
- devnm command, 141
- /dev/xlv directory, 65
- df command and XLV, 202
- direct I/O, 202
- directories
  - as a type of file, 108
  - cleaning temporary, 161
  - definition, 106
  - hidden, 119
  - standard IRIX, 102
  - temporary, 168
  - /tmp and /var/tmp, 161
- directory organization, 102
- disk blocks
  - bad block handling, 4
  - definition, 4
- disk drives
  - adding a new disk as a filesystem, 122
  - device parameters, 13
  - growing a filesystem onto new, 122
  - identifying controller number and drive address, 20
  - non-SCSI disks, xxiii
  - parameters for GRIO, 197
  - physical structure, 3
  - replacing for a plexed volume, 89
  - supported types, 2
- disk partitions
  - and external log size, 67
  - and volume elements, 62
  - block and character devices, 51
  - considerations in choosing partition layouts, 10
  - creating custom layouts, 32
  - creating standard layouts, 31
  - definition, 4
  - device names, 141
  - displaying with prtvtoc, 26
  - making an XFS filesystem, 132
  - on older systems, 8
  - overlapping, 5
  - partition numbers, names, and functions, 6
  - planning, 131
  - repartitioning, 131
  - repartitioning during conversion, 144
  - repartitioning with fx, 27
  - sizes for striped volume elements, 68
  - standard partition layouts, 6
  - types, 11
- Disk Plexing Option, 58
- disk quotas
  - accounting, 165
  - and mount command, 155, 165, 169
  - description, 123
  - edquota command, 171, 214
  - group, 170, 172
  - imposing on EFS filesystems, 213
  - imposing on XFS filesystems, 169
  - monitoring, 215
  - project, 170, 172
  - quot command, 166, 167, 175
  - quota command, 174
  - quotacheck command, 215

- quotaoff command, 166, 214
  - quotaon command, 169, 214
  - repquota command, 173
  - user, 169, 171
  - disk space
    - estimating with `xfs_estimate`, 149
    - files that grow, 160
    - for logs, 129
    - getting more, 151
    - growing a logical volume, 80
    - identifying large users, 163
    - increasing for XFS, 149
    - monitoring free inodes, 159
    - monitoring free space, 159
    - unused files, 158
  - dos (fat) filesystem, 118
  - drive addresses
    - identifying, 20
    - setting, 3
  - du command, 164
  - dump command
    - commands used during conversion to XFS, 142, 148
    - requirements for conversion to XFS, 151
    - when to use, 112
  - dvhtool command
    - adding files to the volume header, 22
    - and volume element sizes, 68
    - description, 13
    - examining a volume header, 23
    - removing files in the volume header, 24
- E**
- edquota command, 171, 214
  - EFS filesystems
    - and XLV logical volumes, 52
    - checking for consistency, 207, 210
    - description, 113, 205
    - fragmentation, 212
    - history, xxiii
    - inodes, 206
    - maximum file size, 113, 205
    - maximum filesystem size, 113, 205
    - reorganizing, 213
    - XLV subvolumes, 67
  - efs partition type, 11
  - error recovery
    - disabling for GRIO, 197-200
  - `/etc/config/ggd.options` file, 204
  - `/etc/fstab` file
    - entries for filesystems, 137, 155
    - entries for system disk, 142
    - entries for XLV logical volumes, 75, 99, 196
  - `/etc/grio_disks` file, 192, 202
  - `/etc/init.d/grio` file, 200
  - `/etc/init.d/quotas` file, 214
  - `/etc/init.d/rmtmpfiles` file, 161
  - `/etc/nodelock` file, 72
  - `/etc/rc2.d/S94grio` file, 192
  - exportfs command, 113
  - Extended Attributes, 111
  - extent size, 126, 194, 196
  - extents
    - EFS filesystem, 206
    - indirect, 206
    - XFS filesystem, 111
  - external logs
    - and log subvolumes, 53
    - creating with `mkfs`, example, 135
    - definition, 7, 128
    - disk partitions for, 11
    - example, 76
    - See also logs.
    - size, 130

**F**

`fcntl` system call, 111, 201

## files

- and hard links, 108
- and symbolic links, 108
- definition, 105
- files that grow, 160
- information in inodes, 107
- locating unused, 162
- possible unused files, 158
- types, 108

filesystem directory format, 127

## filesystems

- adding space, 121
- checking for consistency, 177-180, 207, 210
- corruption, 124, 177
- creating, 118
- definition, 105
- foreign filesystems, 118, 138, 180
- mounting, 119, 154-??
- names, 110
- NFS, 113
- `/proc`, 114
- remote, 157
- routine administration tasks, 153
- See also EFS filesystems, XFS filesystems.
- unmounting, 120, 157

FLEXlm licenses, xxvii

- Disk Plexing Option, xxvi, 58, 66
- High Performance Guaranteed-Rate I/O, xxvi, 186

font conventions, xxiv

foreign filesystems, 118, 138, 180

formatting disks, 4, 21

fragmentation, 212, 213

## fsck command

- description, 207, 210
- using, 211, 215-229

`fsck_cacheefs` command, 114

`fsr` command, 121, 212, 213

`fsr_efs` command, 212

`fsr_xfs`, 121

## fx command

- and device parameters, 13
- and partition types, 11
- in volume header, 12
- IRIX version, 30
- repartitioning disks, 27-36
- repartitioning example, 38, 43
- standalone version, 28
- standard vs. custom partitions, 11
- using expert mode to assign partition types, 12
- using the standalone version, 145
- versions for different processors, 29

**G**

## ggd daemon

- description, 192
- restarting, 197, 200

## GRIO

- configuring the ggd daemon, 200
- creating an XLV logical volume for, 193
- deadline scheduling, 191
- default guarantee options, 189
- description, 185, 186
- disabling disk error recovery, 197-200
- features, 186
- file descriptors, 187
- file formats, 202-204
- guarantee types, 189-191
- hard guarantees, 193
- hardware configuration requirements, 193
- lock file, 192
- non-scheduled reservations, 191
- overview, 186
- per-file guarantees, 189
- per-file system guarantees, 189

private guarantees, 189  
 rate, 186  
 real-time scheduling, 191  
 reservations, 186  
 shared guarantees, 189  
 sizes to choose, 188  
 streams, 186  
 system components, 192  
 guaranteed-rate I/O. See GRIO.

## H

hard errors, 66  
 hard guarantees, 193  
 hard links, 108  
 hardware graph, 115  
 hardware requirements, 110, 193  
 heads, recording, definition, 3  
 hfs (mac) filesystem, 118  
 hidden directories, 119  
 /hw filesystem, 115  
 hwgraph, 115

## I

ide diagnostics program, 12  
 initializing a disk, 21  
 inodes  
   checking by `fsck`, 217  
   description, 107  
   in EFS filesystems, 206  
   monitoring free inodes, 160  
   XFS filesystems, 111  
 internal logs  
   and the data subvolume, 53  
   and `xfsllog` partitions, 11  
   creating with `mkfs`, example, 134

definition, 7, 129

See also logs.

size, 130

`ioconfig` command, 117

IRIX administration documentation, xxi-xxii, xxvii

IRIX directory organization, 102

iso9660(CD-ROM) filesystem, 118

## J

journaling information, 58, 111

## L

links, 108

`ln` command

  creating hard links, 109

  creating mnemonic names, 36

  creating symbolic links, 109

log size, 129

logical volume labels

  and logical volume assembly, 65

  daemon that updates them, 65

  definition, 12

  information used at system startup, 57

  removing with `dvhtool`, 24

  written by `xlvmake`, 72

logical volumes

  adding plexes, 82

  advantages, 52

  coming up at system startup, 57, 65

  creating, examples, 73-76

  creating, overview, 54

  definition of volume, 56

  deleting objects, 85

  description, 51

  detaching plexes, 84

  device names, 65

- disadvantages, 52
- displaying objects, 79
- example (figure), 54
- growing, 80
- hierarchy of objects, 54
- increasing size, 80
  - lv, 51
- moving to a new system, 57, 65
- naming, 65
- read and write errors, 66
- removing labels in volume headers, 24
- See also XLV logical volumes.
- selecting subvolumes, 67
- sizes, 67
- striping, choosing stripe unit size, 63
- striping, definition and illustration, 53
- used as raw devices, 51, 57
- volume composition, 56
- XLV. See XLV logical volumes.

logs

- choosing size, 129
- choosing type, 129
- creating external with `fx`, 11
- description, 128
- example of external, 76
- external, definition, 128
- external, specifying size, 130
- internal log, when used, 67
- internal, definition, 129
- internal, specifying size, 130
- size syntax, 130

lost+found directories, 118

lv logical volumes

- converting to XLV, 97
- no longer supported, 51

lv\_to\_xlv command, 97

lvlab logical volume labels, 12, 25

## M

- major device numbers, 16
- MAKEDEV command, 14
- manual pages, xxvii
- metadata, filesystem, 53
- miniroot, using for filesystem administration, 121
- minor device numbers, 16
- mkfs command
  - command line syntax, 133, 135, 149
  - example commands, 207
  - example output, 133, 135
  - for GRIO, 196
- mknod command, 14
- mnemonic device file names, 36
- mount command, 154-157, 165, 169
- mount point, 119
- mounting filesystems
  - and disk quotas, 155, 165, 169
  - CacheFS filesystems, 114
  - description, 119
  - illustration, 106, 119
  - methods, 120
- mpadmin command, 200

## N

- named pipes, 108
- NFS compatibility, 111
- NFS filesystems, 113, 157
- non-scheduled reservations, 191

## O

- optimal I/O size, 194, 202
- option disks



adding a new, 49-50  
 definition, 6  
 possible partition layouts, 9  
 turning into a system disk, 42

## P

partitions. See disk partitions.  
 per-file guarantees, 189  
 per-filesystem guarantees, 189  
 platters, definition, 3  
 plex revives, 60, 83  
 plexes  
   adding to volumes, 82  
   booting off alternate root, 95  
   checking for required software, 72  
   definition, 59  
   deleting, 85  
   detaching, 84  
   Disk Plexing Option, xxvi, 58  
   displaying, 79  
   example of creating, 75, 76  
   for root filesystem, 92  
   holes in address space, 59, 68  
   monitoring plex revives, 83  
   mounting, 86  
   plex composition, 60  
   read and write errors, 66  
   removing, 86  
   See also logical volumes.  
   volume element sizes, 68  
   when to use, 68  
 prerequisite hardware, 110, 193  
 private guarantees, 189  
 /proc filesystems, 114  
 prtvtoc command  
   description, 13  
   displaying disk partitions, 26

## Q

quot command, 166, 167, 175  
 quota command, 174  
 quotacheck command, 215  
 quotaoff command, 166, 214  
 quotaon command, 169, 214  
 quotas file, 213  
 quotas subsystem, 123

## R

raw device files. See character device files.  
 raw partition type, 11  
 real-time files, 201  
 real-time process, 200  
 real-time scheduling, 191  
 real-time subvolumes  
   and utilities, 201  
   creating files, 201  
   GRIO files, 186  
   hardware requirements, 193  
   only real-time on disk, 59  
 reference pages, xxvii  
 remote filesystems, 157  
 repartitioning  
   definition, 10  
   example, 38, 43  
   See also disk partitions.  
 repquota command, 173  
 reserved partition, 6  
 restore command  
   and XFS filesystems, 112  
   commands used during conversion to XFS, 146,  
   149  
 retry mechanisms, 193

root filesystem  
  and `fsck`, 207, 210  
  and the miniroot, 121  
  booting off an alternate plex, 95  
  combining with `usr`, 151  
  converting to XFS, 140  
  definition, 106  
  dumping, 142  
  mounting and unmounting restrictions, 120  
  on plexed logical volume, 92  
  repairing, 184  
  restoring all files, 146  
  restrictions, 68  
  running out of space, 168  
  standard directories, 102

root partition, 6  
  and striping, 68  
  and XLV, 66  
  combining with `usr` partition, 145  
  converting to XFS, 140-147  
  device name, 141

`/root` prefix for files, 121

## S

sash standalone program, 13

scripting XLV configurations, 100

SCSI address. See drive addresses.

`scsiadminswap` command, 92

`scsihotswap` command, 92

`scsiquiesce` command, 92

sgilabel  
  creating with `fx`, 13  
  description, 12

shared guarantees, 189

special files. See device files.

stripe unit, 131  
  choosing, 63

  definition, 63

striped volume elements. See volume elements.

striping disks  
  choosing stripe unit size, 63  
  description and illustration, 53

subvolumes  
  composition, 57  
  data subvolume definition, 58  
  displaying, 79  
  log subvolume definition, 58  
  real time subvolume definition, 59  
  See also logical volumes.  
  subvolume types, 58

super-blocks, 206, 226-229

surfaces, definition, 3

swap partition, 6, 157

symbolic links  
  as a type of file, 108, 109  
  dangling, 109  
  definition, 109  
  for older pathnames, 102

`symmon` standalone program, 12

system administration documentation, xxi-xxii, xxvii

system disks  
  creating by cloning, 46-48  
  creating from IRIX, 42-46  
  creating from the PROM Monitor, 37-42  
  definition, 6  
  possible partition layouts, 7  
  required disk partitions, 6

## T

temporary directories  
  cleaning, 161  
  setting `TMPDIR`, 168

tracks, definition, 4

**U**

UDF filesystem, 118  
 umount command, 157  
 unit number. See drive addresses.  
 UNIX domain sockets, 108  
 unmounting filesystems  
   methods, 120  
   umount command, 157  
 unwritten extents, 127  
 usr filesystem  
   combining with root filesystem, 151  
   converting to XFS, 140  
   dumping, 142  
   required for system operation, 120  
   restoring all files, 147  
   standard directories, 104  
 usr partition, 6  
   combining with root partition, 145  
   device name, 141  
 /usr/lib/libgrio.so, 192

**V**

volhdr partition, 6  
 volhdr partition type, 11  
 volume elements  
   changing size with `dvhtool`, 68  
   definition, 62  
   deleting, 85  
   displaying, 79  
   multipartition volume elements, 64, 69  
   single partition volume elements, definition, 62  
   striped, definition, 63  
   striped, example of creating, 75  
   striping, when to use, 68  
 volume header  
   adding files, 22

  examining with `dvhtool`, 23  
   removing files, 24  
 volume headers  
   description, 12  
   when used, 13  
 volume partition, 6  
 volume partition type, 11  
 volumes. See logical volumes.

**W**

warm-plug feature, 92

**X**

`xdkm` command, 26  
 XFS filesystem  
   allocation groups, 130  
   directory format, 127  
   stripe unit, 131  
 XFS filesystems  
   adding space, 121  
   and standard commands, 112  
   block sizes, 111, 126  
   changing size, 122  
   checking for consistency, 120, 177  
   commands, 112  
   converting a system disk, 140-147  
   converting an option disk, 148  
   copying with `xfscopy`, 176  
   corruption, 124, 177  
   creating, 118  
   description, 110  
   extents, 111  
   features, 110  
   filesystem on a new disk partition, 132  
   history, xxiii  
   inodes, 107

- journaling information, 58
- logs. See logs.
- making filesystems, 132-137
- maximum file size, 111
- maximum filesystem size, 111
- mounting, 119, 154-??
- names, 110
- on system disk, 140
- preparing to make filesystems, 125-152
  - restore compatibility, 112
  - unmounting, 120, 157
- xfs partition type, 11
- xfs\_check command
  - description, 120
  - how to use, 177
- xfs\_copy command, 176
- xfs\_estimate command, 149
- xfs\_growfs command
  - description, 122
  - example, 81
  - extending a filesystem onto a logical volume, 138, 209
- xfs\_repair command
  - repairing filesystems, 180-183
  - repairing root filesystem, 184
  - using to check filesystems, 177
  - using to repair filesystems, 178
- xfsdump command, 112
- xfslog partition, 6
- xfslog partition type, 11
- x fsm command
  - creating an XFS filesystem, 132
- xfsrestore command, 112
- XLV logical volumes
  - configuring system for more than ten, 97
  - converting lv logical volumes, 97
  - creating out of old and new disks, 138, 209
  - creating spare objects, 81
  - daemons, 65
  - do not use, 66
  - error policy, 66
  - history, xxiii
  - names, 51
  - no configuration file, 65
  - overview, 52-66
  - planning logical volumes, 66-69
  - recording configuration, 99
  - See also logical volumes.
  - with EFS, 52
- xlv partition type, 11
- xlv\_labd daemon, 65
- xlv\_make command
  - and disk partition types, 74
  - GRIO example, 196
  - using to create a logical volume for an existing filesystem, 138, 209
  - using to create volume objects, 72-76
- xlv\_mgr command
  - adding a plex, 82
  - checking that plexing software is installed, 72
  - deleting volume objects, 85
  - detaching a plex, 84
  - displaying objects, 79
  - growing a volume, 80
- xlv\_plexd daemon, 65, 86
- xlvd daemon, 65
- xlvlab logical volume labels. See logical volume labels.
- xlv m command, 71
- XVM logical volumes, 7, 51
- XVM Volume Manager, 1